



*Buildings and Infrastructure Protection Series*

# Aging Infrastructure: Issues, Research, and Technology

*BIPS 01 / December 2010*



**Homeland  
Security**

Science and Technology



---

Buildings and Infrastructure Protection Series

# Aging Infrastructure: Issues, Research, and Technology

BIPS 01 / December 2010



**Homeland  
Security**

Science and Technology

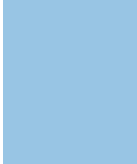

**T**he views, opinions, findings, conclusions, or recommendations expressed in this publication are those of the authors and do not necessarily reflect the official policy or position of the Department of Homeland Security (DHS) and other federal agencies. The publication of these views by DHS does not confer any individual rights or cause of action against the United States. Users of information from this publication assume all liability from such use.

Any appearances of hyperlinks do not constitute endorsement by DHS of the website or the information, products, or services contained therein. For links outside DHS, DHS does not exercise any editorial control over the information you may find at these locations. Users must adhere to any intellectual property rights contained in this publication or in material in linked websites.

# Foreword

**B**ecause science and technology are crucial to mitigating natural and manmade threats to critical infrastructure and ensuring the continuity of their services, the U.S. Department of Homeland Security (DHS) Science and Technology (S&T) Directorate has established a goal to accelerate the delivery and understanding of enhanced technology that addresses the challenges of aging infrastructure. The DHS S&T Infrastructure Protection and Disaster Management Division (IDD) supports this goal by funding the creation of a research agenda to develop improved technical options for upgrading and increasing the service life of aging infrastructure.

To that end, the DHS S&T Directorate sponsored the Aging Infrastructure Workshop, held at Columbia University, New York City, on July 21-23, 2009. This workshop mainly addressed transportation infrastructure; the similarities to other infrastructure, such as energy infrastructure, were also emphasized. Through white paper discussions and breakout sessions, participants in the workshop explored topics such as the roles and challenges facing stakeholders, decisionmaking methods, solutions to aging infrastructure issues, and infrastructure investment prioritization, including the current economic stimulus package.

This publication reproduces most of the papers delivered at the workshop. It also includes a few that were received but not presented and an appendix that summarizes the breakout sessions held during the workshop.



Christopher Doyle,  
Director  
Infrastructure Protection and Disaster Management Division  
Science & Technology Directorate  
U.S. Department of Homeland Security

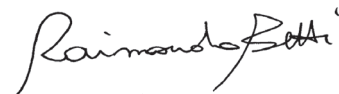

Raimondo Betti,  
Professor  
Department of Civil Engineering  
and Engineering Mechanics  
Columbia University



# Acknowledgments

The Infrastructure Protection and Disaster Management Division of the Department of Homeland Security's Science and Technology Directorate would like to thank Columbia University School of Civil Engineering and Engineering Mechanics for the donation of conference space and support. In addition, we would like to thank the Paper Review Committee for its valued work. Many papers were submitted to the workshop committee for consideration as a result of the call for papers. All papers were reviewed by two independent reviewers. Some of the requirements for acceptance were originality, completeness, and suitability to the workshop goals. We acknowledge the efforts of the reviewers in this process. They provided expert technical opinions in a timely manner, and their efforts helped ensure presentation of high quality papers and, ultimately, achievement of the workshop's desired goals. These reviewers are:

Sreenivas Alampalli, New York State Department of Transportation

Chris Arnold, President, Building Systems Development Inc.

Larry Baier, New Jersey Department of Environmental Protection

Raimondo Betti, Columbia University

Alex Cheng, University of Mississippi

Rich Cooper, Catalyst Partners, LLC

Richard Drake, New York State Energy Research and Development Authority

Bill Flynn, DHS Office of Infrastructure Protection

Earle Kennett, National Institute of Building Sciences

Chris McKay, DHS Transportation Security Administration

Paul Mlakar, U.S. Army Engineer Research and Development Center

Stella Rozelman, New York City Department of Environmental Protection

Rae Zimmerman, New York University





## ACKNOWLEDGMENTS

The Infrastructure Protection and Disaster Management Division of the Department of Homeland Security's Science and Technology Directorate would also like to extend our gratitude to the Workshop Committee for their diligent efforts in organizing and successfully executing this workshop. The committee is:

Mila Kennett-Reston, Program Manager, DHS/S&T/IDD

Mary Ellen Hynes, Director of Research, DHS/S&T/IDD

Eric Letvin, Project Manager, URS Group, Inc. (URS)

Mohammed Ettouney, Senior Technical Advisor and Coordinator,  
Weidlinger

Gwendolyn Hall, Senior Advisor and Logistic Coordinator, URS

Chris Arnold, Editor, Building Systems Development Inc.

Fernando Cortez-Lira, Systems Engineering and Technical Assistance  
Support, Analytical Research, LLC

Pamela Beresford, Editor, DHS/S&T (Transportation Security  
Laboratory)

Thomas Coleman, Advisor and Facilitator, DHS/S&T

Tate Jackson, Senior Engineer and Workshop Support, URS

Laura Seitz, Workshop Support, URS



# Table of Contents

<b>Foreword</b> .....	i
<b>Acknowledgments</b> .....	iii
<b>Chapter 1: Introduction</b> .....	1-1
1.1 Present Conditions and Urgency.....	1-2
1.2 The Influence of Aging.....	1-4
1.3 The Critical Issues.....	1-4
1.4 Organization and Scope of This Publication.....	1-6
<b>Chapter 2: Our Aging Infrastructure: Overview</b> .....	2-1
<b>2.1 Report Card for America's Infrastructure</b> .....	2-4
<i>American Society of Civil Engineers (ASCE)</i>	
2.1.1 What It Is.....	2-4
2.1.2 How the Report Card is Developed.....	2-5
2.1.3 The 2009 Report Card.....	2-5
<b>2.2 The Age of Infrastructure in a Time of Security and Natural Hazards</b> .....	2-6
<i>R. Zimmerman, C.E. Restrepo, and J.S. Simonoff</i>	
2.2.1 Introduction.....	2-6
2.2.2 Factors Potentially Reinforcing Infrastructure Age Problems .....	2-7
2.2.2.1 Environmental Factors.....	2-7
2.2.2.2 Design .....	2-8

TABLE OF CONTENTS

2.2.3 Causes of Infrastructure Failures ..... 2-9

2.2.3.1 Hazardous Liquid Distribution Pipelines ..... 2-9

2.2.3.2 Natural Gas Transmission and Distribution..... 2-9

2.2.3.3 Electric Power ..... 2-10

2.2.3.4 Bridges ..... 2-10

2.2.3.5 Dams..... 2-12

2.2.4 Conclusions..... 2-15

2.2.5 Acknowledgements and Disclaimer..... 2-15

2.2.6 References..... 2-15

**2.3** **The Impact of Aging Infrastructure on Security** ..... 2-18  
*Harry A. Capers Jr., P.E. and Meghann M. Valeo*

2.3.1 Introduction..... 2-18

2.3.2 How does Aging affect Security and Performance? ..... 2-19

2.3.2.1 Metrics for Aging..... 2-19

2.3.3 Rehabilitation/Replacement of Aging Infrastructure ..... 2-23

2.3.3.1 Standoff Distance ..... 2-25

2.3.3.2 Visibility ..... 2-25

2.3.3.3 Technology ..... 2-25

2.3.3.4 Improved Lighting ..... 2-25

2.3.3.5 Reduce Accessibility to Key Structural Elements..... 2-26

2.3.3.6 Redundancy ..... 2-26

2.3.4 Conclusion ..... 2-27

**2.4** **A Bridge to Prosperity: Resilient Infrastructure Makes a Resilient Nation**..... 2-28  
*Mitchell D. Erickson, Ph.D.*

2.4.1 Introduction..... 2-28

2.4.2 Our Aging Infrastructure ..... 2-29

2.4.3 Homeland Security Benefits of a Resilient Infrastructure ..... 2-32

2.4.4 A Roadmap to Resiliency..... 2-33

2.4.5 Examples of Challenges and Opportunities ..... 2-38

2.4.6 Models for Our Future ..... 2-44

2.4.7	A National Coalition.....	2-46
2.4.8	The 2009 National Academy of Sciences Report.....	2-46
2.4.9	Concepts.....	2-48
2.4.10	S&T Opportunities and Obligations .....	2-51
2.4.11	Conclusions.....	2-54
2.4.12	Acknowledgments.....	2-55

### Chapter 3: Bridges: A Critical Issue..... 3-1

#### **3.1 Aging Infrastructure— Roles and Challenges** ..... 3-4 *Sheila Rimal Duwadi*

3.1.1	Introduction.....	3-4
3.1.2	Roles & Responsibilities .....	3-5
3.1.3	The Highway System.....	3-5
3.1.4	Aging versus Other Hazards.....	3-6
3.1.5	The Impact of Aging .....	3-7
3.1.6	Security versus Aging .....	3-8
3.1.7	Summary .....	3-9
3.1.8	References.....	3-9

#### **3.2 Suspension Bridge Cables: 200 Years of Empiricism, Analysis and Management**..... 3-10 *Dr. Bojidar Yanev*

3.2.1	Empiricism and Theory.....	3-10
3.2.2	Failure: The Ultimate Test .....	3-11
3.2.2.1	19th Century cable-supported bridges.....	3-12
3.2.2.2	Tacoma Bridge (1940) .....	3-13
3.2.2.4	Partial Failures.....	3-14
3.2.2.5	General Observations.....	3-15
3.2.3	Suspension Bridge Cables .....	3-18
3.2.3.1	Wires: Condition, Deterioration, and Failure .....	3-18
3.2.3.1.1	Wire Stresses .....	3-22
3.2.3.1.2	Residual Stresses.....	3-23

3.2.3.2	Cables: Condition, Deterioration, Maintenance, and Repair.....	3-23
3.2.3.2.1	Design and Construction .....	3-23
3.2.3.2.2	Wind Loads.....	3-24
3.2.3.2.3	Stress Distribution .....	3-24
3.2.3.3	Anchorage.....	3-26
3.2.3.4	Uncertainty.....	3-27
3.2.3.5	Innovations and Trends .....	3-27
3.2.4	Acknowledgment.....	3-30
3.2.5	References.....	3-30
	<b>Aging Cables in Suspension Bridges.....</b>	<b>3-32</b>
	<i>Raimondo Betti, Ah Lum Hong, Dyab Khazem, Mark Carlos, and Richard Gostaudas</i>	
3.3.1	Introduction .....	3-32
3.3.2	Background on Corrosion of Suspension Bridge Cables.....	3-34
3.3.3	Indirect Sensing Technologies .....	3-38
3.3.3.1	LPR Sensors (Analatom Inc.) .....	3-39
3.3.3.2	Coupled Multielectrode Array Sensors and Bi-metallic Sensors (CorrInstrument Inc.) .....	3-41
3.3.3.3	Temperature and Relative Humidity Sensors.....	3-42
3.3.3.4	Fiber Optic Sensors .....	3-43
3.3.4	Direct Sensing Technologies .....	3-43
3.3.4.1	Main Flux Method .....	3-44
3.3.4.2	Magnetostrictive Technology and Acoustic Emission .....	3-45
3.3.5	Cable Mock-Up .....	3-47
3.3.6	Preliminary Results .....	3-50
3.3.7	Preliminary Field Installation .....	3-51
3.3.8	Conclusions.....	3-52
3.3.9	Acknowledgements .....	3-52
3.3.10	References .....	3-53

<b>3.4</b>	<b>Integrating Baseline Structural Modeling, Structural Health Monitoring and Intelligent Transportation Systems for Condition Assessment of In-Service Bridges</b> .....	3-54
	<i>E.S. Bell and J.D. Sipple</i>	
3.4.1.	Introduction .....	3-54
3.4.1.1	Social Need .....	3-54
3.4.1.2	Baseline Modeling .....	3-55
3.4.1.3	Structural Health Monitoring Data .....	3-56
3.4.1.4	Intelligent Transportation Systems .....	3-57
3.4.1.5	The Whole Is Greater Than the Sum of Its Parts .....	3-57
3.4.2	Rollins Road Bridge, Rollinsford, New Hampshire .....	3-59
3.4.2.1	Background .....	3-59
3.4.2.2	Instrumentation Plan .....	3-62
3.4.2.3	Displacement Measurement Using Digital Imaging and Surveying Equipment .....	3-64
3.4.2.4	Field Testing .....	3-65
	3.4.2.4.1 Truck Specifications .....	3-65
	3.4.2.4.2 Testing Plan .....	3-66
3.4.2.5	Structural Modeling .....	3-66
3.4.2.6	Prestressing Tendons .....	3-67
3.4.2.7	Carbon Fiber Reinforced Polymer in the Deck .....	3-67
3.4.2.8	Bridge Rail .....	3-68
3.4.2.9	Elastomeric Bearing Pads .....	3-69
3.4.2.10	Load Application .....	3-70
3.4.3	Verification Results .....	3-71
3.4.3.1	Conclusions on Manual Parameter Estimating Results .....	3-72
3.4.3.2	Analysis of Removing Specific Structural Elements .....	3-74
3.4.4	Conclusions .....	3-75
3.4.4.1	Special Studies .....	3-75
3.4.4.2	Integration with Intelligent Transportation Management System .....	3-76
3.4.5	References.....	3-76

<b>3.5</b>	<b>Bridge Vulnerabilities and the Practical Application of Advanced Composite Materials for Hardening, Strengthening, and Extending Service Life</b> .....	3-80
	<i>Amjad Aref, Ph.D. and Jerome S. O'Connor, P.E.</i>	
3.5.1	Introduction.....	3-80
3.5.2	Potential Role for Composites .....	3-85
3.5.2.1	Composites for Bridge Decks and Superstructures.....	3-87
3.5.3	State of the Practice .....	3-92
3.5.4.	Research Needs.....	3-94
3.5.5	Conclusion .....	3-96
3.5.6	References.....	3-96
3.5.7	Disclaimer .....	3-97
<b>3.6</b>	<b>Managing Aging Bridges and Their Networks</b> .....	3-97
	<i>R.B. Testa, H.C. Wu, M.J. Garvin, and B. Yanev</i>	
3.6.1	Introduction.....	3-97
3.6.2	Single Bridge Life-cycle Cost Model.....	3-101
3.6.2.1	Deterioration and Life .....	3-101
3.6.2.2	Life-Cycle Costs.....	3-104
3.6.2.3	Network Model and Objectives .....	3-104
3.6.2.4	Bridge Network Optimal Strategies .....	3-105
3.6.2.6	Three Steel Bridge Network .....	3-108
3.6.2.7	More Complex Networks .....	3-108
3.6.2.8	Selecting an Optimal Strategy .....	3-110
3.6.3	Conclusion .....	3-111
3.6.4	References.....	3-112

## Chapter 4: Prioritization, Decionmaking, and Management ..... 4-1

<b>4.1</b>	<b>Decision Technology for Rational Selection of Infrastructure Investments: A Pressing Research Need and Grand Opportunity at an Historic Moment</b> .....	4-4
	<i>J. Reese Meisinger</i>	
4.1.1	The Problem and Opportunity.....	4-4
4.1.2	Overview Of The High-Risk, High-Reward Research .....	4-9
4.1.3	Conclusion .....	4-13
<b>4.2</b>	<b>A Threat Independent Approach to Evaluating the Sustainability of Our Critical Infrastructure</b> .....	4-14
	<i>Shalva Marjanishvili, Ph.D., P.E., S.E. and Eve Hinman, Eng. Sc.D., P.E</i>	
4.2.1	Introduction.....	4-14
4.2.2	Risk and Reliability .....	4-14
4.2.3	Resiliency and Robustness.....	4-16
4.2.4	Protective Design of Robust Systems .....	4-18
4.2.5	All Hazards Approach .....	4-19
4.2.6	Conclusions .....	4-20
4.2.7	References.....	4-21
<b>4.3</b>	<b>Five Integrated Aspects of Aging Infrastructure Management: A Basis for Decision-Making at the United States Army Corps of Engineers (USACE)</b> .....	4-22
	<i>Richard W. Woolridge, Jose E. Sanchez, David P. Hale, and G. Edward Gibson, P.E.</i>	
4.3.1	Introduction.....	4-22
4.3.2	Asset Management at the USACE.....	4-23
4.3.2.1	Asset Management Framework (AUF).....	4-25
4.3.2.2	Five Aspects of AMF Model.....	4-28
4.3.2.3	Aspect Interaction .....	4-29
4.3.3	Detailed Decomposition of the Five AMF Aspects.....	4-33
4.3.3.1	Purpose .....	4-34



TABLE OF CONTENTS

4.3.3.2	Artifact.....	4-35
4.3.3.3	Action.....	4-36
4.3.3.4	Mechanism.....	4-37
4.3.3.5	Resource.....	4-38
4.3.4	Combining top-down and bottom-up Implementation .....	4-39
4.3.5	Application of Five Aspects to Other Infrastructures.....	4-42
4.3.6	References.....	4-42
	<b>4.4 A Multi-Objective Approach for the Management of Aging Critical Highway Bridges .....</b>	<b>4-44</b>
	<i>Z. Lounis, L. Daigle, D. Cusson, and H. Almansour</i>	
4.4.1	Introduction.....	4-44
4.4.2	Multi-Objective Management of Aging Bridges.....	4-47
4.4.3	Strategies for Management of Critical Bridges.....	4-52
4.4.3.1	Performance-Based Inspection .....	4-53
4.4.3.2	Quantitative Condition Assessment and Deterioration Prediction .....	4-54
4.4.3.3	Continuous/Semi-Continuous Structural Health Monitoring.....	4-56
4.4.3.4	Continuous Security Monitoring.....	4-58
4.4.3.5	Rehabilitation, Strengthening and Protection of Critical Bridge Systems and Components .....	4-58
4.4.4	Illustrative Examples.....	4-60
4.4.5	Discussion.....	4-71
4.4.6	Conclusions.....	4-71
4.4.7	References.....	4-72



## Chapter 5: Advanced Methods for Evaluation ..... 5-1

<b>5.1</b>	<b>Centrifuge Modeling of Steel Piles Under Lateral Impact Loads.....</b>	<b>5-4</b>
	<i>Hoe I. Ling, Logan Brant, Rene B. Testa, Raimondo Betti, and Andrew Smyth</i>	
5.1.1	Introduction.....	5-4
5.1.2	Scaling Laws and Properties .....	5-5
5.1.3	Soil, Pile, and Fluid Properties .....	5-6
5.1.4	Experimental Procedures .....	5-8
5.1.5	Results and Observations .....	5-10
5.1.6	Sampling Of Other Results .....	5-14
5.1.7	Conclusions .....	5-18
5.1.8	References .....	5-18
<b>5.2</b>	<b>Digital Color Image Processing Methods for Assessing Bridge Coating Rust Defects.....</b>	<b>5-20</b>
	<i>Sangwook Lee, Ph.D.</i>	
5.2.1	Introduction.....	5-20
5.2.2	Previous Image Processing Methods .....	5-21
5.2.2.1	NFRA Method.....	5-21
5.2.2.2	SKMA Method .....	5-22
5.2.3	Limitations for Bridge Coating Evaluations.....	5-23
5.2.3.1	Issues on Image Acquisition Conditions.....	5-23
5.2.3.2	Lessons and Motivations .....	5-26
5.2.4	Architecture of Novel System Development.....	5-27
5.2.4.1	Color Space Selection .....	5-27
5.2.4.1.1	Investigated Color Spaces.....	5-27
5.2.4.1.2	Distribution Patterns of Rust Defects.....	5-29
5.2.4.1.2	Optimal Color Space .....	5-29
5.2.4.2	Further Model Development .....	5-31
5.2.4.2.1	Hotelling Transform .....	5-32
5.2.4.2.2	Histogram Generation .....	5-34

	5.2.4.2.3	Image Reconstruction .....	5-34
	5.2.4.2.4	Assessment of Defects .....	5-35
	5.2.4.3	Model Testing and Results .....	5-35
5.2.5		Conclusions.....	5-37
5.2.6		References.....	5-37
	<b>5.3</b>	<b>The Electrochemical Fatigue Sensor (EFS) .....</b>	<b>5-39</b>
		<i>Monty A. Moshier, Ph.D. and Marybeth Miceli</i>	
5.3.1		Introduction.....	5-39
	5.3.1.1	The EFS System .....	5-40
		5.3.1.1.1 The EFS Sensor .....	5-41
		5.3.1.1.2 The EFS Electrolyte .....	5-42
		5.3.1.1.3 The EFS Potentiostat Data Link.....	5-42
		5.3.1.1.4 The EFS Software .....	5-43
5.3.2		The EFS System and Bridge Management.....	5-43
	5.3.2.1	Traditional Inspection Tool .....	5-43
	5.3.2.1	A Tool for Prioritizing Repairs .....	5-44
	5.3.2.3	A Tool for Verifying the Efficacy of Repairs.....	5-44
5.3.3		Pennsylvania Inspections - Case Study.....	5-45
5.3.4		Inspections Performed In New York .....	5-47
5.3.5		Inspections Performed In Virginia.....	5-49
5.3.6		Summary .....	5-51
5.3.7		References.....	5-52
5.3.8		Acknowledgements.....	5-52
	<b>5.4</b>	<b>Health Monitoring of Reinforced and Pre-Stressed Concrete Structures Using Time of Flight Information of Guided Waves.....</b>	<b>5-53</b>
		<i>Tribikram Kundu, Tri Huu Miller, Tamaki Yanagita, Julian Grill, and Wolfgang Grill</i>	
5.4.1		Introduction.....	5-53
5.4.2		Corrosion Of Reinforcing Bars.....	5-55
5.4.3		Corrosion Monitoring by Ultrasonic Guided Waves: Current State of Knowledge .....	5-56

5.4.4	Corrosion Monitoring by Ultrasonic Guided Waves: From TOF (Time Of Flight) Information .....	5-60
5.4.4.1	Experimental Results.....	5-60
5.4.5	Conclusions.....	5-62
5.4.6	Acknowledgement.....	5-63
5.4.7	References.....	5-65
<b>5.5</b>	<b>A Hierarchical Fuzzy Expert System for Risk of Failure of Water Mains</b> .....	<b>5-69</b>
	<i>Hussam Fares and Tarek Zayed</i>	
5.5.1	Introduction.....	5-69
5.5.2	Literature Review.....	5-70
5.5.2.1	Failure of Water Distribution System .....	5-71
5.5.2.2	Consequences of Failure.....	5-71
5.5.2.3	Risk of Water Main Failure .....	5-72
5.5.2.4	Fuzzy Expert Systems.....	5-73
5.5.2.5	Risk Modeling .....	5-74
5.5.2.5.1	Matrix models .....	5-74
5.5.2.5.2	Probabilistic models.....	5-74
5.5.2.5.3	Indexing models .....	5-75
5.5.3	Research Methodology.....	5-75
5.5.4	Risk Factors Incorporated In The Current Research.....	5-77
5.5.5	Data Collection .....	5-78
5.5.5.1	City of Moncton, New Brunswick, Canada, Case Study .....	5-79
5.5.6	Hierarchal Fuzzy Expert System For Water Main Risk Of Failure.....	5-80
5.5.6.1	Determining Membership Functions of Various Factors .....	5-81
5.5.6.2	Fuzzy Inference.....	5-84
5.5.6.3	Consequent Aggregation .....	5-85
5.5.6.4	Defuzzification Process .....	5-87
5.5.6.5	Proposed Risk of Failure Scale .....	5-87

5.5.7	The Developed HFES Application to Case Study, City of Moncton, New Brunswick, Canada.....	5-88
5.5.7.1	Case Study Analysis.....	5-88
5.5.8	Conclusions.....	5-91
5.5.9	References.....	5-91
<b>5.6</b>	<b>Integrated Condition Assessment Model and Classification Protocols for Sewer Pipelines</b> .....	5-94
	<i>Fazal Chughtai and Tarek Zayed</i>	
5.6.1	Introduction.....	5-94
5.6.2	Sewer Condition Classification Protocols.....	5-95
5.6.3	Self-Organizing Maps .....	5-98
5.6.4	Research Methodology.....	5-99
5.6.5	Data Collection .....	5-101
5.6.6	Modified Ceriu Sewer Pipeline Protocol .....	5-101
5.6.6.1	Defect Ranking.....	5-101
5.6.6.2	Assigning Transformed Deduct Values for CERIU Classifications.....	5-102
5.6.6.3	Development of Self-Organizing Maps .....	5-103
5.6.6.4	Proposed Modification in CERIU Protocols.....	5-105
5.6.6.5	Results of Model Implementation and Verification .....	5-106
5.6.7	Combined Condition Index (CCI) for Sewer Pipelines.....	5-106
5.6.7.1	Clustering the Combined Condition Matrix .....	5-107
5.6.7.2	The Proposed Combined Condition Index for Sewer Pipelines .....	5-108
5.6.7.3	Verification of the Proposed CCI .....	5-110
5.6.7.4	Automated Conversion of Structural and Operational Ratings into CCI .....	5-111
5.6.7.5	Validation of CCI Regression Model.....	5-112
5.6.8	Summary and Conclusions.....	5-113
5.6.9	Acknowledgment.....	5-113
5.6.10	References.....	5-114

<b>5.7</b>	<b>Strength Prediction for Adhesive Anchors: Elastic Analysis</b> .....	5-115
	<i>H.M. Yin and R.B. Testa</i>	
5.7.1	Introduction.....	5-115
5.7.2	The Uniform Bond Stress Model.....	5-118
5.7.3	Basic Formulation.....	5-120
5.7.4	Results and discussion .....	5-125
5.7.5	Conclusions.....	5-128
5.7.6	Acknowledgements.....	5-128
5.7.7	References.....	5-128
<b>5.8</b>	<b>A Stochastic Diagnostic Model for Subway Stations</b> .....	5-130
	<i>Nabil Semaan and Tarek Zayed</i>	
5.8.1	Introduction.....	5-130
5.8.2	Background.....	5-131
5.8.3	Sources Of Uncertainty In The Ssdi Model .....	5-132
5.8.4	Stochastic Global Station Diagnosis Model (Gsdm).....	5-133
5.8.4.1	The GSDM Methodology.....	5-133
5.8.4.2	Criteria Definition .....	5-133
5.8.4.3	Criteria Weights .....	5-134
5.8.4.4	Multi-Criteria Aggregation.....	5-134
5.8.4.5	Station Outranking .....	5-135
5.8.5	SFI and GDI Development.....	5-136
5.8.6	Data Collection .....	5-137
5.8.6.1	SDM Application To STM.....	5-137
5.8.6.2	The GSDM Application.....	5-138
5.8.6.3	Analysis of Results.....	5-138
5.8.6.4	Sensitivity Analysis .....	5-139
5.8.7	Conclusions.....	5-140
5.8.8	References .....	5-140

**Chapter 6: Economic and Social Issues and Impacts** ..... 6-1

**6.1 State of the Stimulus: The Impact on Infrastructure Protection and a Way Forward** ..... 6-4

*Rich Cooper, Principal, Catalyst Partners, LLC*

- 6.1.1 Ineffective Infrastructure Projects and Spending..... 6-4
- 6.1.2 The Same Old Game ..... 6-5
- 6.1.3 Stimulus Impact on Infrastructure Development ..... 6-6
- 6.1.4 A National Infrastructure Strategy..... 6-7
- 6.1.5 Push for the Formation of a National Infrastructure Strategy..... 6-8
- 6.1.6 Enact and Constitute a National Infrastructure Bank..... 6-9
- 6.1.7 Make Resilience a Part of the Infrastructure Design from the Beginning..... 6-9
- 6.1.8 Infrastructure Development and a Way Forward ..... 6-10

**6.2 Optimizing America’s Infrastructure Portfolio For the 21st Century** ..... 6-12

*Jerry P. Brashear, Ph.D., and James T. Creel*

- 6.2.1 The Challenge ..... 6-12
- 6.2.2 The “Clients” for a Solution..... 6-12
- 6.2.3 Project Objective and Scope ..... 6-13
- 6.2.4 A Feasible, Transparent Solution..... 6-13
- 6.2.5 Outcomes ..... 6-16
- 6.2.6 Next Steps ..... 6-17
- 6.2.7 Time Is of the Essence. .... 6-17

**Chapter 7: Observations and Conclusions**..... 7-1

**7.1 Roles, Challenges, and Recommended Solutions** ..... 7-2

- 7.1.1 Short-Term Challenges..... 7-3
- 7.1.2 Long-Term Challenges ..... 7-4
- 7.1.3 Improving Multidisciplinary Cooperation ..... 7-4

**7.2 Infrastructure Health** ..... 7-5

7.2.1 Specific Critical Infrastructures Health Issues ..... 7-6

7.2.2 Short-Term Priorities to Improve Infrastructure Health..... 7-7

**7.3 Role and Importance of Multihazards Considerations**..... 7-8

**7.4 Investments In Infrastructures**..... 7-9

7.4.1 Infrastructure Short-Term Priorities..... 7-10

7.4.2 Infrastructure Long-Term Priorities ..... 7-11

**7.5 Social And Economic Impacts**..... 7-11

7.5.1 Important Social and Economical Issues with  
the Largest Impacts That Should Be Maximized..... 7-12

7.5.2 Investments That Would Maximizes Those Issues..... 7-13

**7.6 Decisionmaking Processes: Prioritization Methods**..... 7-13

7.6.1 Performance Requirements for Metrics..... 7-14

7.6.2 Workshop Suggestions for Metrics (using  
resiliency as an example): ..... 7-14

7.6.3 Role of Private Sector in Adopting Metrics..... 7-15

**7.7 Infrastructures Of The Future** ..... 7-16

7.7.1 General Issues ..... 7-16

7.7.2 Characteristics of Infrastructures of the Future..... 7-17

7.7.3 Investments for Infrastructures of the Future..... 7-18

**Appendix A** .....A-1

Workshop Breakout Sessions: Topic Matrices

**Tables**

**Chapter 2**

Table 2-1: Disruption ..... 2-8

Table 2-2: Descriptive Statistics for Age of Dams by Hazard Level, New York State ..... 2-13

**Chapter 3**

Table 3-1: NY area bridges which were identified to have main cable corrosion..... 3-36

Table 3-2: Excerpt of the 2000 Rollins Road Bridge Inspection Report (NHDOT, 2007) ..... 3-61

Table 3-3: Excerpt from the 2007 Rollins Road Bridge Inspection Report (NHDOT, 2007) ..... 3-62

Table 3-4: Manual model updating cases and corresponding bearing pad stiffness values for second analysis ..... 3-72

Table 3-5: Manual model updating cases and corresponding bearing pad stiffness values for third analysis ..... 3-74

Table 3-6: Challenges Facing Bridge Owners ..... 3-82

Table 3-7: Potential Bridge Failure Modes..... 3-84

Table 3-8: Potential Benefits of Composites..... 3-91

Table 3-8: Potential Benefits of Composite (cont.) ..... 3-92

Table 3-9: Maintenance Tasks and Components ..... 3-101

**Chapter 4**

Table 4-1: Design Assumptions made in the 20th century that are inconsistent with the 21st century all-hazard approach ..... 4-20

Table 4-2: Multi objective-based prioritization of critical bridge structures..... 4-61



**Chapter 5**

Table 5-1:	Relevant Centrifuge Scaling Relations.....	5-6
Table 5-2:	Nevada Sand Soil Properties (Arulmoli et al., 1992) ...	5-7
Table 5-3:	Typical Scaled Pile Properties .....	5-7
Table 5-4:	Testing Summary .....	5-11
Table 5-5:	Deformed Pile Shape Summary .....	5-15
Table 5-6:	Selected Color Spaces .....	5-28
Table 5-7:	Tabulated Results from the Six Inspected Locations .	5-46
Table 5-8:	Summary of November Results .....	5-49
Table 5-9:	Summary of June 2008 Results .....	5-49
Table 5-10:	Summary of Results .....	5-50
Table 5-11:	Applied load as a function of time. H stands for 700 g hanger.....	5-62
Table 5-12:	Variation of the applied load as a function of time for the loading shown in Figure 5-44.....	5-63
Table 5-13:	Variation of the applied load as a function of time for the loading shown in Figure 5-44.....	5-64
Table 5-14:	Sample environmental factors performance combined impact.....	5-87
Table 5-15:	Case Study Results Summary .....	5-89
Table 5-16:	Case Study Pipes Evaluation And Rehabilitation Plan Statistics of Fair and Risky Status	5-89
Table 5-17:	Severity Condition Grades for WRc Protocol .....	5-97
Table 5-18:	Severity Condition Grades for CERIU Protocol .....	5-98
Table 5-19:	WRc Ranking Weights for Common Structural and Operational Defects .....	5-102



TABLE OF CONTENTS

Table 5-20:	Transformed Deduct Values of Structural and Operational Condition Classes (CERIU).....	5-103
Table 5-21:	Group Divisions for CERIU Transformed Deduct Values for Structural Defects .....	5-105
Table 5-22:	Holistic CERIU Structural and Operational Condition Classes for Sewers .....	5-105
Table 5-23:	Comparison between the Structural and Operational Condition Classes of the Modified CERIU and WRc According to Peak deduct Values .....	5-106
Table 5-24:	The Five Categories of the Combined Condition Index (CCI) .....	5-108
Table 5-25:	Proposed Combined Condition Index (CCI) for Sewers.....	5-109
Table 5-26:	Important Statistical and Validation Diagnostics for the CCI Regression Model.....	5-112
Table 5-27:	The SSDI Condition Scale (adapted from Semaan, 2006) .....	5-146
Table 5-28:	The GSDM Criteria Definition .....	5-147
Table 5-29:	Summary of Criteria Weights Statistical Analysis Results .....	5-148
Table 5-30:	The GSDM Criteria Values Input .....	5-148
Table 5-31:	The statistical output of the stochastic GSDM for station S1.....	5-149
Table 5-32:	Deterministic SDI values for S1 to S7.....	5-149
 <b>Chapter 6</b>		
Table 6-1:	Summary of the Financial vs. Infrastructure Portfolio Optimization Processes .....	6-15

## Figures

### Chapter 2

Figure 2-1:	Number of dams by year built, New York State .....	2-3
Figure 2-2:	ASCE March 2009 Infrastructure Report Card .....	2-5
Figure 2-4:	Number of Structurally Deficient and Obsolete Bridges in Each Time Period as a Percentage of the Number of Bridges Built in Each Time Period, New York State, 1800-2005.....	2-11
Figure 2-3:	Distribution of Bridges by Year Built, New York State, 1800-2005 .....	2-11
Figure 2-5:	Bridges with a Superstructure Condition Rating of Poor or Worse as a Percentage of Total Bridges Built in that Time Period, New York State .....	2-12
Figure 2-6:	Histogram of number of dams by year built, New York State .....	2-13
Figure 2-7:	Histogram of number of dams (N=375) by year built for high hazard dams, New York State.....	2-14
Figure 2-8:	Histogram of number of dams (N=694) by year built for significant hazard dams .....	2-14
Figure 2-9:	Histogram of number of dams (N=715) by year built for low hazard dams .....	2-14
Figure 2-10:	Summary of Sufficiency Rating Factors .....	2-21
Figure 2-11:	Threats and Hazards for Multi-Modal Transportation Systems .....	2-22
Figure 2-12:	Relationship between Maintenance, Condition, and Time.....	2-27
Figure 2-13:	Growth of population, GDP, vehicles, and total highway lane-miles .....	2-30
Figure 2-14:	Resilience dramatically reduces loss following a disaster.....	2-32

TABLE OF CONTENTS

Figure 2-15: Expanding roles for Resiliency..... 2-34

Figure 2-16: Xcel Energy’s SmartGrid City ..... 2-39

Figure 2-17: Exit 14, Newark, NJ. .... 2-43

**Chapter 3**

Figure 3-1: Highway Statistics ..... 3-6

Figure 3-2: Box Beam Bridge Failure in Pennsylvania ..... 3-7

Figure 3-3: Corrosion of a steel member..... 3-8

Figure 3-4. Bridge failures in the United States 1966—  
2005 (courtesy STV Engineers) ..... 3-12

Figure 3-5. Brooklyn, Manhattan and Williamsburg bridges ..... 3-13

Figure 3-6. Tacoma Narrows Bridge ..... 3-13

Figure 3-7: Whitestone Bridge in the 1980s..... 3-14

Figure 3-8: Cracked eye-bar of suspension bridge ..... 3-14

Figure 3-9. Wire breaks and corrosion stages (NCHRP  
Report 534, Mayrbaurl and Camo, 2004) ..... 3-19

Figure 3-10. Wire breaks and corrosion stages ..... 3-21

Figure 3-11: Examples of suspension cable during (a)  
wedging inspection and (b) wrapping ..... 3-23

Figure 3-12: Examples of anchorages with (a) eye-bars and  
re-anchored strand and (b) shop-fabricated strands . 3-26

Figure 3-13: Dry air injection at Kurushima Bridge ..... 3-28

Figure 3-14. Examples of (a) Suspension and (b) Stay Cables..... 3-29

Figure 3-15: Cable model at Columbia University ..... 3-30

Figure 3-16: Number of broken wires along the cables of  
Centennial Bridge during its rehabilitation ..... 3-35

Figure 3-17: 49-Wire bundle to be placed in corrosion chamber ..... 3-40

Figure 3-18: Corrosion rate reading from LPR sensors during accelerated corrosion test. .... 3-40

Figure 3-19: Corroded LPR sensor after one-week test..... 3-41

Figure 3-20: Schematic representation of Bi-metallic sensor probe..... 3-42

Figure 3-21: Bobbin for MFM Tokyorope system mounted on 20-inch diameter cable ..... 3-44

Figure 3-22: Relation between Magnetic Flux and number of wires in the cable cross-section for MFM technology (Tokyorope Inc.)..... 3-46

Figure 3-23: Maximum amplitude of the signals detected by the MsS-AE technique on the 127 wire strand as function of the reduction in cross section area due to 5 wires cut: (a) sensors located before the wire cut location. (b) Sensors located after the wire cut location. .... 3-47

Figure 3-24: Cable mock-up with environmental chamber ..... 3-48

Figure 3-25: Sensor location in the cable’s cross-section ..... 3-49

Figure 3-26: Temperature and relative humidity measurements inside the cable mock-up..... 3-50

Figure 3-27: Corrosion rate measurements from LPR sensors..... 3-50

Figure 3-28: Location of Rollins Road Bridge ..... 3-60

Figure 3-29: Rollins Road Bridge prior to new bridge construction..... 3-60

Figure 3-30: New Rollins Road Bridge, opened in 2000..... 3-61

Figure 3-31: Graphic of sensors used in Rollins Road Bridge analysis; (a) shows the sensors in section view and (b) shows the sensors in plan view .. 3-63

TABLE OF CONTENTS

Figure 3-32: Digital Camera Set up for Digital Image Correlation at Rollins Road Bridge ..... 3-64

Figure 3-34: NHDOT sand truck as load application during April 2008 load test ..... 3-65

Figure 3-33: Photo of load test while survey crew takes displacement reading ..... 3-65

Figure 3-35: Trooper Huddleston (NH State Police) taking NHDOT wheel load measurements ..... 3-66

Figure 3-36: Final model of Rollins Road Bridge in SAP2000® ..... 3-67

Figure 3-37: Graphical representation of how CFRP is modeled as layered shell element ..... 3-68

Figure 3-38: Section view of bridge rail connection to bridge deck ..... 3-68

Figure 3-39: Deformations of a laminated elastomeric bearing pad ..... 3-69

Figure 3-40: Truck load mesh to bridge deck graphic ..... 3-71

Figure 3-41: Manual model updating using girder 3 top strain sensors ..... 3-72

Figure 3-42: Quantification of bearing pad stiffness examples ..... 3-73

Figure 3-43: Quantification of bearing pad stiffness results ..... 3-73

Figure 3-44: Manual model updating using girder 3 top strain sensor ..... 3-74

Figure 3-45: Court Street Bridge, Owego, NY: a) top left, steel retrofit to prevent steel corrosion from splitting the pedestal apart; b) top right, application of fiber reinforced polymer wrap to confine the deteriorated column; c) bottom, structural configuration of the 70-year-old bridge. .... 3-87

Figure 3-46:	Prefabricated FRP deck being installed on prefabricated prestressed concrete beams. Bettendorf, Iowa.....	3-88
Figure 3-47:	(a) Composite Decks Weigh 25%-30% of Conventional Decks and, (b) Live Load Capacity Can Often Be Improved Dramatically .....	3-89
Figure 3-48:	Schuyler Heim Lift Bridge Long Beach, CA.....	3-91
Figure 3-49:	Wearing Surface Debonded from FRP Deck .....	3-95
Figure 3-50:	Condition and Sufficiency Ratings for 600 Vehicular Bridges in New York City.....	3-99
Figure 3-51:	Deterioration Rate Models .....	3-102
Figure 3-52:	Chromosomes Defined .....	3-107
Figure 3-53:	Three Concrete Bridge Network.....	3-109
Figure 3-54:	Three Steel Bridge Network .....	3-109
Figure 3-55:	Complex Network .....	3-110
 <b>Chapter 4</b>		
Figure 4-1:	Five Aspects of Asset Management (Woolridge et al. Paper 4.3) .....	4-3
Figure 4-2:	Infrastructure Demand and Capacity Dependency ...	4-15
Figure 4-3:	Demand and Capacity are Uncorrelated and Independent.....	4-16
Figure 4-4:	Illustration of Robustness .....	4-17
Figure 4-5:	AMF Component Structure .....	4-26
Figure 4-6:	Five Aspects of Asset Management.....	4-29
Figure 4-7:	Hierarchy of Artifacts .....	4-30
Figure 4-8:	Hierarchy of Purposes.....	4-31



## TABLE OF CONTENTS

Figure 4-9:	Goals, Metrics, and Measures for Value and Risks .....	4-35
Figure 4-10:	Artifact Conditions for Purpose .....	4-36
Figure 4-11:	Informational and Physical Actions .....	4-37
Figure 4-12:	Mechanism's People, Process, Tools, and Data .....	4-38
Figure 4-13:	Resources for Mechanism, Action, Physical, and Informational .....	4-39
Figure 4-14:	Impacts of deterioration, preservation, and protection on life cycle performance of bridges ..	4-46
Figure 4-15:	Framework for multi-objective management of aging highway bridges .....	4-49
Figure 4-16:	Schematic illustration of Pareto optima and conflicting optimization objectives .....	4-51
Figure 4-17:	Schematic illustration of a crossing problem with stochastic load and capacity.....	4-55
Figure 4-18:	Schematic of structural health and security monitoring systems of bridges.....	4-57
Figure 4-19:	Normalized Values of Prioritization Criteria for Maintenance and Protection Projects.....	4-62
Figure 4-20:	Weighted and non-weighted multi-objective criticality indices.....	4-62
Figure 4-21:	Cross-section of reconstructed barrier wall (Vachon Bridge, Laval, Canada) .....	4-63
Figure 4-22:	Measured and predicted profiles of total chloride content after 10 years.....	4-64
Figure 4-23:	Measured apparent surface chloride contents and chloride diffusion coefficients over 10 years .....	4-65
Figure 4-24:	Sensitivity analysis of time to rebar corrosion and time to concrete spalling .....	4-66



Figure 4-25:	CNR Bridge near Renfrew, Canada.....	4-67
Figure 4-26:	Location of sensors in typical test section.....	4-68
Figure 4-27:	Corrosion potential in patches .....	4-69
Figure 4-28:	Corrosion potential in old concrete.....	4-70
<b>Chapter 5</b>		
Figure 5-1:	Centrifuge Facilities, Columbia University .....	5-5
Figure 5-2:	(a) Model pile with closed tip (left) and (b) automatic sand hopper (right) .....	5-9
Figure 5-3:	Testing Device.....	5-10
Figure 5-4:	Pile Response Subjected to Varied Loading Rates .....	5-11
Figure 5-5:	Pile Response Subjected to Varied Loading Rates in Dry and Saturated Soil Deposits.....	5-12
Figure 5-7:	Relationships between Changes in Pore Pressure and Pile Cap Displacement vs. Time.....	5-13
Figure 5-6:	PPT Location .....	5-13
Figure 5-8:	Graphs Showing Effects of Varied Pile Stiffness (EI)	5-14
Figure 5-9:	Bending Moment vs. Depth.....	5-14
Figure 5-10:	Examples of Force vs. Time & Displacement vs. Time Graphs .....	5-16
Figure 5-11:	Differences in effected soil region caused by loading conditions .....	5-16
Figure 5-12:	Axial Pile Resistance vs. Embedment Relationships	5-17
Figure 5-13:	Strain vs. Embedment .....	5-18
Figure 5-14:	Non-uniform Illumination ((a) Original coating image, (b) Grayscale image, (c) Processed image by NFRA method, and (d) Processed image by SKMA method) .....	5-24

TABLE OF CONTENTS

Figure 5-15: Low-contrast Images ((a) Original coating image, (b) Grayscale image, (c) Processed image by NFRA method, and (d) Processed image by SKMA method) ..... 5-25

Figure 5-16: Noises on Painting Surfaces ((a) Original coating image, (b) Grayscale image; (c) Processed image by NFRA method, and (d) Processed image by SKMA method) ..... 5-26

Figure 5-17: Scatter Plot Image Representation..... 5-30

Figure 5-18: Adjustment of Coordinate System..... 5-31

Figure 5-19: Effect of Hotelling Transform ..... 5-34

Figure 5-20: Processed Result under Non-uniform Illumination... 5-35

Figure 5-21: Processed Result of Low-contrast Image ..... 5-36

Figure 5-22: Processed Result of Noises on the Surfaces..... 5-36

Figure 5-23: (a) Schematic of the EFS sensor (b) Schematic of EFS System in use (c) Photograph of EFS sensor ..... 5-41

Figure 5-24: The EFS wireless access point antenna (back) with the numbered PDLs and individual wireless antennae (front). Sensors and electrolyte shown in foreground. .... 5-43

Figure 5-26: Typical cracked coped detail at the floor beam to girder connection. Photo on the right shows the detail with the EFS installed. .... 5-45

Figure 5-25: Bridge located near Harrisburg; southbound span shown here. .... 5-45

Figure 5-27: EFS response from an actively growing crack at the coped detail..... 5-47

Figure 5-28: EFS Sensors Installed Near Retrofit ..... 5-48

Figure 5-29: Output of Frequency Domain of Location 1a ..... 5-48

Figure 5-31: Output of Frequency Domain of Location 1b..... 5-48

Figure 5-30: Output of Time Domain of Location 1a..... 5-48

Figure 5-32: Output of Time Domain of Location 1b..... 5-48

Figure5-33: Inspection locations on VDOT Highway  
Bridge Structure ..... 5-49

Figure 5-34: Location 3 – 4th Beam, 1st Diaphragm ..... 5-50

Figure 5-35: Output of Time Domain of Location 3..... 5-51

Figure 5-36: Output of Frequency Domain of Location 3,  
Energy Ratio = 2.60 ..... 5-51

Figure 5-37: Progression of corrosion damage with time  
in reinforced concrete. Points (a) through  
(e) are located at different stages of the  
corrosion process and are illustrated in  
Figure 5-38 (after Ervin and Reis 2008)..... 5-55

Figure 5-38: Progressive stages of corrosion process in  
RC structure. Points a through e are located  
in different stages of the corrosion process  
model shown in Figure 5-37 (after Ervin and  
Reis 2008). ..... 5-56

Figure 5-39: Four steel bars showing different degrees of  
corrosion – un-corroded case (bottom bar) to  
highly corroded case (top bar)..... 5-57

Figure 5-40: Received guided wave strength after the wave  
propagated through four 3-feet long steel  
bars with different degrees of corrosion (see  
Figure 5-39) in concrete. .... 5-58

Figure 5-41: Received guided wave strength after the  
wave propagated through four reinforced  
concrete specimens with different degrees of  
separation between the steel rod and the concrete. . 5-58

Figure 5-43: A typical rebar used for concrete  
reinforcement. Note the non-uniform cross-section.. 5-59

Figure 5-42: Two guided wave modes A and B are propagating from the transmitter T to receiver R. Energy profile of mode A makes it more sensitive to the interface condition (corrosion etc.) but also let more energy leaking into surrounding concrete. The situation is reverse for mode B. .... 5-59

Figure 5-44: Reinforced beam is loaded by a transverse load P. Guided wave is sent from transmitter T to receiver R through the steel rod of this loaded beam. .... 5-60

Figure 5-45: A steel rod is loaded by a transverse load P by placing weights on the 700 g h anger. Guided wave is sent through the rod from transmitter T to receiver R. .... 5-61

Figure 5-46: Time of flight variation for a plain steel rod during loading-unloading cycles described in Table 5-11. .... 5-62

Figure 5-47: Variation of TOF of the guided wave propagating through the steel rebar placed in the reinforced concrete beam for the load variation shown in Table 5-12. (a) corroded rebar, (b) non-corroded rebar ..... 5-64

Figure 5-48: Variation of TOF of the guided wave propagating through a non-corroded steel rebar placed in the reinforced concrete beam for the load variation shown in Table 5-13. .... 5-64

Figure 5-49: Research Methodology ..... 5-76

Figure 5-50: Hierarchical risk factors of water main failure ..... 5-77

Figure 5-51: Water main data collection process..... 5-78

Figure 5-52: Risk factors normalized global weights ..... 5-79

Figure 5-53: Percentage of pipe materials used in Moncton..... 5-80

Figure 5-54: Full view of the model components ..... 5-81

Figure 5-55:	Sample membership functions for various factors.....	5-83
Figure 5-56:	Proposed methodology for fuzzy rules extraction.....	5-86
Figure 5-57:	Proposed risk of failure scale .....	5-88
Figure 5-58:	Decision-making flow chart. ....	5-89
Figure 5-59:	Proposed rehabilitation area (Risky and Fair pipelines) .....	5-90
Figure 5-60:	Historical Background of Sewer Condition Assessment Protocols Development.....	5-96
Figure 5-61:	Proposed Protocol Integration Methodology.....	5-100
Figure 5-62:	Development of methodology of the Combined Condition Index (CCI) .....	5-100
Figure 5-63:	Categorical Output for CERIU Transformed Deduct Values of Structural Defects.....	5-104
Figure 5-64:	Sewer Pipeline Combined Condition Matrix .....	5-107
Figure 5-65:	Fitted Response Plane Plot .....	5-112
Figure 5-66:	Schematic illustration of an epoxy adhesive anchor system under a tensile load. (a) Typical adhesive anchor assembly; (b) Model of an adhesive anchor .....	5-116
Figure 5-67:	Shear stress distributions vs. $z$ along the inner ( $r=a$ ) and outer ( $r=b$ ) surfaces .....	5-125
Figure 5-68:	Effect of embedment depth on the load capacity of the anchor .....	5-126
Figure 5-69:	Effect of thickness of the adhesive layer on the load capacity of the anchor .....	5-126
Figure 5-70:	The GSDM Methodology.....	5-142
Figure 5-72:	The GSDM GPF .....	5-142



TABLE OF CONTENTS

Figure 5-73: Criterion C1 Weight Histogram and Probability Distribution Function ..... 5-142

Figure 5-74: Criterion C1 Critical Threshold CT1 Histogram & Probability Distribution Function ..... 5-143

Figure 5-75: Criterion C1 Tolerance Threshold TT1 Histogram & Probability Distribution Function ..... 5-143

Figure 5-76: GDI output for Station S1 ..... 5-144

Figure 5-77: Stochastic GDI vs. Deterministic SDI outputs ..... 5-145

Figure 5-78: Stochastic GDI Confidence Levels ..... 5-145

Figure 5-79: GDI sensitivity analysis tornado graph for station S1 ..... 5-146

**Chapter 7**

Figure 7-2: Methods of improving coordination ..... 7-5

# Introduction



## In this chapter:

The importance of infrastructure to both the fabric of society and its economy is becoming increasingly more apparent. The current challenge facing us is to shape the infrastructure in a manner that clearly benefits the Nation today and meets the demands of future generations, supports a sustainable environment, promotes energy conservation, provides protection and resilience to the infrastructure, accelerates economic growth, creates new jobs, and, as a whole, results in the United States becoming more economically competitive globally.

## 1.1 Present Conditions and Urgency

The importance of infrastructure to both the fabric of society and its economy is becoming increasingly more apparent. Its fragility as it ages is brought into focus by incidents like the I-35W bridge collapse in Minneapolis, but the problems are generally pervasive and less evident. Public (Federal and State) expenditures on infrastructure have grown slowly (1.7% per year) from 1956 to 2004, and slightly more (2.1%) in recent years. The American Society of Civil Engineers (ASCE) indicated in a recent report that our infrastructure is failing and that it would take an estimated \$1.6 trillion to upgrade the existing infrastructure. Other government reports include similar findings and estimate upgrade needs at \$225 billion for roads, \$202 billion for wastewater treatment, \$72 billion for waterways, \$18 billion for airports, \$11 billion for drinking water treatment, \$10 billion for dams, and \$127 billion for schools. Along the same lines, the U.S. Department of Transportation estimated in 2006 that freight bottlenecks and delayed deliveries due to congested highways and inefficient rail and deep-water transportation systems cost the United States \$200 billion annually.

The robustness of infrastructure systems can be judged by their capacity to accommodate change over time.

The robustness of infrastructure systems can be judged by their capacity to accommodate change over time. Earlier this year, the Congressional Budget Office reported that the percentage Federal spending for infrastructure in proportion to all Federal spending has steadily declined over the last 30 years. Our current infrastructure increasingly fails to meet demands. Facilities are aging; their level of service, reliability, and performance are decreasing; and increasingly they are extended into natural environments and fragile ecosystems. The dangers that the Nation's crumbling infrastructure poses to our economic health are as great as those posed by the current financial crisis.

The current challenge facing us is to shape the infrastructure in a manner that clearly benefits the Nation today and meets the demands of future generations, supports a sustainable environment, promotes energy conservation, provides protection and resilience to the infrastructure, accelerates economic growth, creates new jobs, and, as a whole, results in the United States becoming more economically competitive globally. In the past, infrastructure has not been required to meet such a diverse number of requirements; however, the rapid rate at which our infrastructure is aging requires new solutions for



The dangers that the Nation's crumbling infrastructure poses to our economic health are as great as those posed by the current financial crisis.



providing a resilient infrastructure that can last for future generations.

Two issues are paramount in looking at our aging infrastructure: what is the present condition and how urgent is it to expend significant public funds to effect its repair, replacement, and management improvement; what are the priorities across the range of infrastructure types.

The simplest statement of the condition of our aging infrastructure aimed at public education is provided in the form of a grade school report card issued periodically by the ASCE. The report card for 2009 is shown below.

This report card is, of course, limited in its information. More information on this example will be found in other papers in this publication; see the papers by Zimmerman et al. On the issues of urgency and resource allocation, a number of authors have written eloquently:

“To achieve the vision of a resilient America, we must commit to a sustained effort across geographic, political, economic, infrastructure sector, and presidential administration boundaries. We must evolve our thinking, investment strategies, and infrastructure to a vision of a strong, resilient America in a complex, dynamic global economy and global society. We must summon the political and social will to pass the laws and appropriations to effect change.” (Mitch Erickson)

“In brief, America’s infrastructure has been ignored for decades, is deteriorating, and is inadequate to support the population growth in the near future. The current economic crisis has underscored these issues, stimulating significant outlays of taxpayer dollars to generate employment in the near term.” (J. Reese Meisinger)

“The number of ‘high hazard’ dams, the failure of which would endanger human life, increased from 9,281 in 1998 to 10,213 in 2007. In the past two years, more than 67 dam incidents, including 29 dam failures, were reported to the National Performance of Dams program. States report more than 3,500 ‘unsafe’ dams with conditions that could cause them to fail.” (J. Reese Meisinger)

### 2009 REPORT CARD

Aviation .....	D
Bridges .....	C
Dams .....	D
Drinking Water .....	D-
Energy .....	D+
Hazardous Waste .....	D
Inland Waterways .....	D-
Levees .....	D-
Public Parks and Recreation .....	C-
Rail .....	C-
Roads .....	D-
Schools .....	D
Solid Waste .....	C+
Transit .....	D
Wastewater .....	D-

**America’s Infrastructure GPA:** ..... **D**

Estimated 5 Year Investment Need:

**\$2.2 Trillion**

## 1.2 The Influence of Aging

**A**ge is one of many factors that affect the performance of infrastructure and its robustness against threats posed by common environmental conditions, extreme natural hazards, and terrorism. Infrastructure age often acts together with other factors such as design, maintenance, and operation in increasing the vulnerability of infrastructure to these threats.

“What is apparent from the information presented above and from the literature is that the significance of age as a factor influencing infrastructure condition is different for different types of infrastructures, agencies, and objectives. Third, relationships identified between age and other infrastructure characteristics related to condition or performance are complicated by the many environmental stresses that infrastructure faces, especially in urban areas, and design practices that limit flexibility.” (Zimmerman et al.).

“The first step in understanding the role of age in infrastructure resiliency and vulnerability is an analysis of the causes of failure and the extent to which these causes can be related to age...”

“The first step in understanding the role of age in infrastructure resiliency and vulnerability is an analysis of the causes of failure and the extent to which these causes can be related to age... It is well known that some of the more devastating bridge

collapses were not due to age but rather to combinations of design, maintenance, operation, and the environmental stresses... The over two dozen bridges that collapsed tracked by the NTSB were not among the oldest, many of which were built in the mid-20<sup>th</sup> century.” (Zimmerman et al.).

## 1.3 The Critical Issues

**R**esearchers participating in this Workshop were asked to focus mainly on transportation and energy-related infrastructure and to explore a number of questions. These questions provide a useful listing of the problems and opportunities facing infrastructure owners and a measure of the complex interacting factors that must be considered as the Nation confronts the tasks of evaluating, prioritizing, repairing, replacing, and managing the infrastructure of the future:

- What are the metrics for aging (performance, function, etc)? What are the current practices that reduce the deterioration rate? How does aging affect security and performance? What are the consequences of aging?

- What are the common intersecting issues among infrastructures? How can these intersections be utilized for better efficiency in improving safety and reducing costs?
- What are current decisionmaking procedures in managing retrofitting/rehabilitating and prioritizing infrastructure (on local, State, and Federal levels)? What are the limitations and advantages of such procedures?
- What are the specific hazards that afflict aging infrastructure (deterioration, sustainability, energy, obsolescence, wear and tear, etc.)? How do these hazards intersect with abnormal hazards, especially manmade hazards?
- What is the role of emerging engineering paradigms in addressing aging infrastructure (performance-based considerations, resiliency, multihazards, etc.)?
- What is the role of advanced technologies in addressing aging infrastructure (superior materials, advanced systems, increased redundancies, etc.)?
- What is the role of Information Technologies in improving performance of aging infrastructure?
- What are efficient, cost-effective, and proven techniques that might be used now for monitoring performance of infrastructure? What are their theoretical and technological underpinnings (sensing, wireless, testing, etc.), their proven efficiency, and their user bases? How can monitoring improve and enhance performance and decisionmaking procedures?
- What is the state of the art in relation to the above issues? What are the knowledge gaps?
- What baseline can be established to expand the Federal Government's knowledge and research in improving the performance of aging infrastructure?

The relatively small number of papers in this publication touch on many of these issues but do not completely cover them. The references appended to each paper show something of the full scope of research and technological activities that have already been conducted on the infrastructure problem. However, the papers present a somewhat random selection of work produced in isolation from any overall conceptual framework, and it is clear from many of papers that such a framework is urgently needed if a useful research agenda is to be developed.

An example of such a framework, which applies to only one type of infrastructure, the Nation's watershed systems, is presented by a team from the United States Army Corps of Engineers, the Federal agency responsible for watershed management. The framework shows the large range of issues that must be organized for one relatively simple and well-understood infrastructure type with a clearly defined manager. This framework is functional only within its own infrastructure type.

The matrices created from the breakout sessions are presented as an appendix in this publication and provide another useful listing of issues and perhaps point the way to the development of a satisfactory conceptual framework.

## 1.4 Organization and Scope of This Publication

**P**apers submitted to this workshop range from experiential accounts from infrastructure managers to theoretical computer simulations from university researchers. They have been organized into five chapters. The chapter titles are broad: a number of papers could be placed in alternative chapters, but cross-reference of topics is perhaps welcome. On the other hand, a number of papers are very narrowly focused on a research topic that relates to a small part of an infrastructure type. The chapters are:

### Chapter 1: Introduction

### Chapter 2: Our Aging Infrastructure: Overview



The papers in this chapter provide an overview of the state of our infrastructure, including the range of problems that exist, and future needs that must be met. Several papers discuss the relationship between age and failure, and there appears to be general agreement that, while aging is not in itself a failure mechanism, it is generally a contributor.

Issues of resiliency are introduced because the importance of a fully functioning infrastructure for the Nation's economic health is critical.

### Chapter 3: Bridges: A Critical Issue



The papers in this chapter all discuss various aspects of bridges. Bridges are engineering structures of critical importance because they are a potential weak link in a pedestrian, highway, or rail system that is essential for the movement of goods and people, and their failure can result in injury and deaths. Millions of people travel over bridges every day: the

Oakland-San Francisco Bay Bridge is traversed by 250,000 vehicles a day and its closure for a month as a result of damage incurred in the Loma Prieta earthquake of 1989 caused major economic losses through lost time. To ensure this does not happen again, it is currently being replaced by a new span that costs over \$5 billion and will open in 2013.

#### Chapter 4: Prioritization, Decisionmaking, and Management



The papers in this chapter deal with the need for acceptable methodologies for prioritization, because resources will always be inadequate for repairing and replacing all deficient infrastructure. Effective decisionmaking methodologies are also necessary that rationally encompass the myriad issues that must be resolved, and refinement in management methods must also be pursued through a combination of experience and analysis.

#### Chapter 5: Advanced Methods for Evaluation



The papers in this chapter focus on a number of advanced methods health monitoring and diagnostics. These papers originate either as university research projects, both theoretical and experimental, or from private proprietary research and development. Evaluation of the state of infrastructure is essential, difficult, and uncertain. Typically, bridges and highways are evaluated by visual inspection on some regular schedule, but weaknesses in engineered structures may be invisible to the naked eye or may develop between inspection intervals.

#### Chapter 6: Economic and Social Issues and Impacts



The papers in this chapter are focused primarily on the technological aspects of infrastructure design, construction, and management, with some emphasis on advanced and innovative methods of solving technical problems. Looming behind the technological issues, which are difficult enough to solve, are longer-term aspects of an economic and social nature. These relate to the investment in infrastructure, which is already huge, though criticized as insufficient, as compared to major investment issues of health, welfare, and national security to name a few.

#### Chapter 7: Observations and Conclusions

This chapter presents in detail, observations and recommendations from workshop attendees. Participants deliberated on the main issues that pertain to aging infrastructure and the general attributes and needs of infrastructure of the future.



# Our Aging Infrastructure: Overview



## **In this chapter:**

The papers in this chapter provide an overview of the state of our infrastructure, including the range of problems that exist, and future needs that must be met. Several papers discuss the relationship between age and failure, and there appears to be general agreement that, while aging is not in itself a failure mechanism, it is generally a contributor. Issues of resiliency are introduced because the importance of a fully functioning infrastructure for the Nation's economic health is critical.

The papers in this chapter provide an overview of the state of our infrastructure, including the range of problems that exist, and future needs that must be met. Several papers discuss the relationship between age and failure, and there appears to be general agreement that, while aging is not in itself a failure mechanism, it is generally a contributor.

“Whether age is used to prioritize infrastructure for rehabilitation or reconstruction will depend on how it has contributed to past condition and performance problems. There are various indications of infrastructure weaknesses and outages that are indicative of age, some of which are described below, but more research is needed to definitively associate these weaknesses. The ASCE (2009) report card for infrastructure cites the poor quality of infrastructure in the U.S., but it is difficult to separate out age as a factor.” (Zimmermann et al., Paper 2.2)



The papers in this chapter provide an overview of the state of our infrastructure, including the range of problems that exist, and future needs that must be met.

“Age might not necessarily be directly indicative of vulnerability, but may suggest design practices that contribute to vulnerability. As discussed in more detail in the section on bridges below, during the 1950s and 1960s, a shift toward non-redundancy in bridge design led to inflexibilities that restricted alternatives when materials were weakened due to maintenance problems. Age has not affected flexibility in some infrastructures. For example, the NYC transit system which is decades old, showed considerable flexibility in being able to recover from the subway damages and shutdowns following the September 11, 2001 attacks on the World Trade Center.” (Zimmermann et al., Paper 2.2)

Issues of resiliency are introduced because the importance of a fully functioning infrastructure for the Nation’s economic health is critical.

“Infrastructure robustness and resiliency represent interdependent qualities of system. Robust systems are inherently more resilient. Probabilistic approach to robustness and resiliency encompass all threats. As such, robust and resilient design represents a true independence from threat.

“Remarkably, there is little common ground regarding the definition of robustness. A quick look at the dictionary reveals five variations of the adjective with three of those five including the word ‘strong’ or ‘strength.’ So, it is natural that engineers, when asked about the meaning of robustness, would reply with words like ‘strong,’ ‘resilient,’ and ‘redundant.’” Marjanishvili and Hinman, Paper 4.2)



“Resiliency is the foundation of preparedness. A resilient society can withstand and/or recover from natural disasters, terrorist attacks, and infrastructure failures. A resilient society can face the challenges of the upcoming decades. Resiliency goes hand-in-hand with capacity. As we improve our resiliency, we simultaneously improve reserve capacity and can design for future demand. Resiliency is a core component of quality of life, prosperity, competitiveness, and security.” (Erickson, Paper 2.4; also see Paper 4.2 by Marjanishvili and Hinman for discussion and definitions of resiliency and robustness)

“The opportunities for America to improve its resiliency depend on, among other things, implementing new technological solutions. The scientific and engineering communities can infuse scientific approaches as well as new technologies into other on-going programs. DHS S&T can contribute through modeling interdependencies, logistics modeling, modeling the intermodal operations, and demonstrating dual use.” (Erickson, Paper 2.4)

The last decade has seen new issues and threats arise that the infrastructure of the future must come to terms with and incorporate in its technology and management to overcome and incorporate.

“Infrastructure will be increasingly faced with threats that potentially compromise its integrity. This is supported by the increasing number of major federally declared disasters, increasing by about 2.7% per year between 1990 and 2005 and the fact that most of the major hurricanes have occurred since 2000... Terrorist attacks, likewise, have targeted infrastructure, particularly transportation... New initiatives in the way that infrastructure is designed can address both new public concerns such as sustainability and security and the problems of condition and performance to which age contributes.” (Zimmermann et al.)

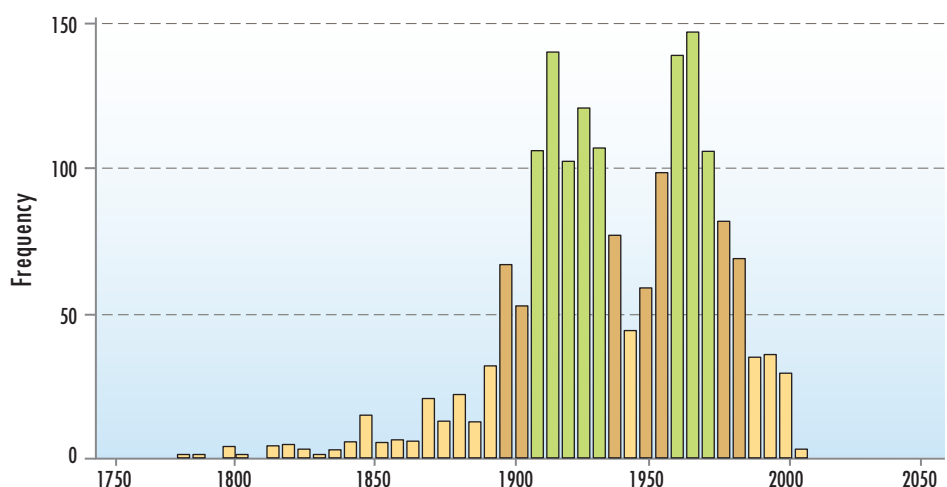

**Figure 2-1:**  
Number of dams by year built,  
New York State

SOURCE: NATIONAL PERFORMANCE OF DAMS PROGRAM (NPDP)



## Papers

**Paper 2.1 Report Card for America's Infrastructure**

*American Society of Civil Engineers (ASCE)*

**Paper 2.2 The Age of Infrastructure in a Time of Security and Natural Hazards**

*R. Zimmerman, C.E. Restrepo, and J.S. Simonoff*

**Paper 2.3 The Impact of Aging Infrastructure on Security**

*Harry A. Capers Jr., P.E. and Meghann M. Valeo*

**Paper 2.4 A Bridge to Prosperity: Resilient Infrastructure Makes a Resilient Nation**

*Mitchell D. Erickson, Ph.D.*

**2.1 Report Card for America's Infrastructure**

*American Society of Civil Engineers (ASCE)*

**2.1.1 What It Is**

As the designers, builders, and maintainers of the nation's infrastructure, civil engineers have a first hand responsibility in ensuring the public safety and economic mobility of the American population. Civil Engineers must learn to use their technical skills to communicate with public policy makers and advocate for the proper funding and regulatory environment to improve the nation's crumbling infrastructure. The Report Card provides engineering professionals with a simple and persuasive tool to help them begin the process. Below is a brief description of the Report Card.

The *Report Card for America's Infrastructure* is the signature public education and advocacy tool for the American Society of Civil Engineers (ASCE). ASCE and its members are committed to protecting the health, safety, and welfare of the public, and as such, are equally committed to improving the nation's public infrastructure. To achieve that goal, the Report Card depicts the condition and performance of the nation's infrastructure in the familiar form of a school report card - assigning letter grades based on physical condition and needed fiscal investments for improvement.



Since 1998, The American Society of Civil Engineers (ASCE) has issued three Infrastructure Report Cards and numerous status updates that depict the current state of America's infrastructure and provide potential solutions for improvement. The *2009 Report Card for America's Infrastructure* was compiled by the Committee on Critical Infrastructure (CCI), and ASCE released the document in March of 2009.

**INFRASTRUCTURE TYPE:** ALL

The Report Card receives widespread media coverage and has been cited in numerous academic studies. The nation’s political leaders also rely on the Report Card to provide them with clear information which they can use as a guide for policy decisions.



The *Report Card for America’s Infrastructure* is the signature public education and advocacy tool for ASCE. The Report Card depicts the condition and performance of the nation’s infrastructure in the familiar form of a school report card - assigning letter grades based on physical condition and needed fiscal investments for improvement.

### 2.1.2 How the Report Card is Developed

To develop the Report Card for America’s Infrastructure, ASCE assembles an advisory panel of the nation’s leading civil engineers, analyzes hundreds of studies, reports and other sources, and surveys thousands of engineers to determine what is happening in the field. The advisory panel determines the scope of the inquiry and establishes a methodology for assigning grades.

For the 2005 Report Card, grades were assigned on the basis of condition and capacity, and funding versus need, generally following a traditional grading scale (e.g., if 77 percent of roads are in good condition or better, that would earn a grade of C). Base grades were then reviewed by the advisory panel and adjusted, usually with a plus or minus but sometimes as much a full letter grade, to reflect positive or negative trends or the critical consequences should a catastrophic failure occur. For example, the failure of a bridge or dam would have much more immediate and deadly consequences than a problem related to solid waste disposal.

### 2.1.3 The 2009 Report Card

ASCE released its latest Report Card in March of 2009 (Figure 2-2). The updated edition features some new elements such as resilience factored into each category, but the essence has remained the same. Additionally, the 2009 Report Card is a key advocacy piece to galvanize public support. By implementing new, user edited technologies such as social networking, the new Report Card features content and solutions provided by the very people who rely on the nation’s infrastructure everyday. ASCE believes the nation is at an important stage

2009 REPORT CARD	
Aviation .....	D
Bridges .....	C
Dams .....	D
Drinking Water .....	D-
Energy .....	D+
Hazardous Waste .....	D
Inland Waterways .....	D-
Levees .....	D-
Public Parks and Recreation .....	C-
Rail .....	C-
Roads .....	D-
Schools .....	D
Solid Waste .....	C+
Transit .....	D
Wastewater .....	D-
<b>America’s Infrastructure GPA:</b> .....	<b>D</b>
Estimated 5 Year Investment Need:	
<b>\$2.2 Trillion</b>	

Figure 2-2: ASCE March 2009 Infrastructure Report Card

where public outcry over inadequate and failing infrastructure will force major planning reforms and increased investment. The Report Card should be the tool to set those priorities.

The Report Card can be accessed online at <http://www.asce.org/reportcard> or on Facebook: “Save America’s Infrastructure” Group. The public is invited to comment on the condition of the nation’s infrastructure on ASCE’s Government Relations Blog, *Our Failing Infrastructure* <http://www.asce.org/govrel/blog>.

## 2.2 The Age of Infrastructure in a Time of Security and Natural Hazards

*R. Zimmerman, C.E. Restrepo, and J.S. Simonoff  
New York University*

### 2.2.1 Introduction

**T**he age of U.S. infrastructure connects in subtle ways with many other threats such as terrorism, natural hazards, and climate change that these facilities and services face. Many new infrastructure initiatives being introduced to address these threats are also likely to address many of the condition and performance problems of aging infrastructure.



This paper evaluates a number of infrastructure areas and types of hazards in order to identify common themes with

respect to how age is associated with infrastructure condition and performance. Other factors that may also contribute to condition and performance problems, such as environmental stresses, usage, design, and operations and maintenance practices, are also considered.

**INFRASTRUCTURE TYPES:** Hazardous liquid distribution, electric power distribution, natural gas distribution, bridges, dams.

Age is one of many factors that affect the performance of infrastructure for its users and its robustness against threats posed by common environmental conditions external to a given infrastructure, extreme natural hazards, and terrorism. Infrastructure age often acts together with and may reinforce the effect of other factors such as design, maintenance, and operation in increasing the vulnerability of infrastructure to these various threats.

New initiatives in the way that infrastructure is designed can address both new public concerns such as sustainability and security and the problems of condition and performance to which age contributes.

Infrastructure will be increasingly faced with threats that potentially compromise its integrity. This is supported by the increasing number of major federally declared disasters, increasing by about 2.7% per year between 1990 and 2005 (Simonoff, Restrepo, Zimmerman and Naphtali 2008) and the fact that most of the major hurricanes have occurred since 2000 (Blake, Rappaport, and Landsea 2007).

Terrorist attacks, likewise, have targeted infrastructure, particularly transportation (Mineta Institute; summarized in Zimmerman and Restrepo 2009) and electric power (Simonoff, Restrepo, and Zimmerman 2007).

Whether age is used to prioritize infrastructure for rehabilitation or reconstruction will depend on how it has contributed to past condition and performance problems. There are various indications of infrastructure weaknesses and outages that are indicative of age, some of which are described below, but more research is needed to definitively associate these weaknesses. The ASCE (2009) report card for infrastructure cites the poor quality of infrastructure in the U.S., but it is difficult to separate out age as a factor. (See *Report Card for America's Infrastructure*, Page 2-4 of this publication)

## 2.2.2 Factors Potentially Reinforcing Infrastructure Age Problems

### 2.2.2.1 Environmental Factors

Environmental factors can reinforce or perhaps override age as a contributor to infrastructure failure. Examples of environmental factors often cited as affecting underground infrastructure include soil movement and pressure created by seasonal freeze-thaw cycles and attack by biological or chemical agents in the underground environment. Other environmental factors related more to human actions include construction interference involving inadvertent breakages of utility lines (backhoe failure), failure to back fill supporting material for other infrastructure after construction, and breakages in water lines during winter months that can cause freezing of water around other utilities lines.

Infrastructures that are in poorer condition due to age can be more vulnerable to such environmental intrusions. A wide range of other environmental factors affect above ground infrastructure facilities that are weather related and also involve destruction by animals and birds.

The relevance of environmental factors as affecting underground infrastructure was underscored by an extensive investigation of water distribution pipes

Age, however, is indicative of the fact that older pipes were not designed to withstand newer stresses associated with increased usage and activities going on around the infrastructure. These stresses, often brought about by nearby energy and transportation infrastructure, include electrical currents, vibration from roadway traffic and construction.

in New York City, which could also apply to energy and transportation networks as well. In the NYC study, the U.S. Army Corps of Engineers found that various environmental factors were associated with pipeline failures, not only age, concluding that “there is no consistent pattern of increasing breaks as pipes get older” (Betz Converse Murdoch Inc. 1980, pp. xiv-xv).

The USACE study particularly cited “beam failure” as contributing to water pipeline breakage, where the supporting subsurface material is worn away or not replaced after construction. Environmental factors other than age were also acknowledged in a nationwide study of water infrastructure needs (U.S. EPA 2002; Cooper 2009). It should be noted that breakage is not the only indication of deteriorating water infrastructure. Leakage rates or lost water is indicative of a wide range of problems. A U.S. EPA (2007) report cited USGS figures of 1.7 trillion gallons of lost water. The relationship of age to leakage rates is an important area of investigation.

Infrastructures are highly interdependent and thus affect one another. Of particular relevance to condition of assets is spatial proximity of infrastructure, which has increased as utilities have found it more economical to locate utility lines in the same corridors. Zimmerman (2004) for example found that breakages in different kinds of distribution systems affected one another with water breakages affecting other infrastructure distribution lines the most: (Table 2-1):

Table 2-1: Disruption

	Ratio Indicating the Number of Times One Infrastructure Caused a Disruption in Another infrastructure vs. Another Infrastructure Disrupting
Water Mains	3.4
Roads	1.4
Sewers/ Sewage Treatment	1.3
Electric Lines	0.9
Gas Lines	0.5
Fiber Optic/Telephone	0.5

### 2.2.2.2 Design

Age might not necessarily be directly indicative of vulnerability, but may suggest design practices that contribute to vulnerability. As discussed in more detail in the section on bridges below, during the 1950s and 1960s,

a shift toward non-redundancy in bridge design led to inflexibilities that restricted alternatives when materials were weakened due to maintenance problems. Age has not affected flexibility in some infrastructures. For example, the NYC transit system which is decades old, showed considerable flexibility in being able to recover from the subway damages and shutdowns following the September 11, 2001 attacks on the World Trade Center (Zimmerman and Simonoff 2009).

### 2.2.3 Causes of Infrastructure Failures

The first step in understanding the role of age in infrastructure resiliency and vulnerability is an analysis of the causes of failure and the extent to which these causes can be related to age. Below is a synopsis of the authors' research findings in the energy area for oil and gas transport and electricity and in transportation with respect to bridges.

#### 2.2.3.1 Hazardous Liquid Distribution Pipelines

Restrepo, Simonoff and Zimmerman (2009, p. 40) found that of the causes of hazardous liquid accidents for those accidents reported, about 12% were attributed to internal and external corrosion which of the various causes cited are the ones that are potentially age-related. When the missing data items are eliminated, this percentage doubles. Thus, if age is related to corrosion (an important research question) then in fact age is indirectly a factor in such accidents.

Two-thirds of the petroleum supply (Rabinow 2004) as well as other materials collectively called hazardous liquids) move through approximately 170,000 miles of U.S. pipelines (Office of Pipeline Safety 2008) (Restrepo, Simonoff and Zimmerman 2009, p. 39).

#### 2.2.3.2 Natural Gas Transmission and Distribution

Natural gas provides about a fifth of the energy usage in the U.S. The transmission and distribution system is vast, and has evolved over many years.

The National Research Council report, Making the Nation Safer (2002) indicated that oil and gas infrastructure was a key source of vulnerability, and this infrastructure area has been included in the critical infrastructure categories that DHS targets for protection.

The analysis of Office of Pipeline Safety data from 2002-2005 by Simonoff, Restrepo and Zimmerman (2009 in preparation) found that as in the case of hazardous liquid pipelines, internal and external

The U.S. gas infrastructure consists of more than 210 natural gas pipeline systems; 302,000 miles of interstate and intrastate transmission pipelines; more than 1,400 compressor stations that maintain pressure on the natural gas pipeline network and assure continuous forward movement of supplies; and more than 11,000 delivery points, 5,000 receipt points, and 1,400 interconnection points that provide for the transfer of natural gas throughout the United States. (Energy Information Administration 2009)

corrosion, potentially a sign of age, accounted for about a quarter of natural gas transmission incidents.

### 2.2.3.3 Electric Power

Weather and equipment failure were found to be leading causes of electricity outages in the U.S. from 1990-2005 with 28% of outages in the U.S. and 40% in Canada accounted for by equipment failure (Simonoff, Restrepo and Zimmerman 2007). Equipment failure is the factor most closely potentially related to age, but could be related to other factors as well. More information about this particular relationship is needed before age can be considered a contributing factor to such outages.

### 2.2.3.4 Bridges

It is well known that some of the more devastating bridge collapses were not due to age but rather to combinations of design, maintenance, operation, and the environmental stresses.

The over two dozen bridges that collapsed tracked by the National Transportation Safety Board (NTSB) were not among the oldest, many of which were built in the mid-20th century. The NTSB, for example, concluded that maintenance problems contributed to the collapse of a section of the Mianus Bridge over I-95 in Connecticut in 1983. That bridge was constructed in 1958. The Schoharie Creek Bridge, which opened in 1954 in New York State, collapsed in 1987. The collapse was attributed to structural elements that contributed to susceptibility to bridge scour that ultimately undermined the bridge supports.

Nevertheless, the National Inventory of Bridges database points to the fact that structural deficiencies and functional obsolescence may be related to age. Bridges in New York State are used as an example to illustrate this point.

Figure 2-3 below gives the distribution of bridges in New York State by the period in which they were built, calculated from the FHWA National Bridge Inventory. Figure 2-4 portrays the declining proportion of bridges that are structural deteriorated and functionally obsolete with decreasing age for New York State bridges. Figure 2-5 gives the declining percentage of bridge superstructures in poor condition with decreasing age.



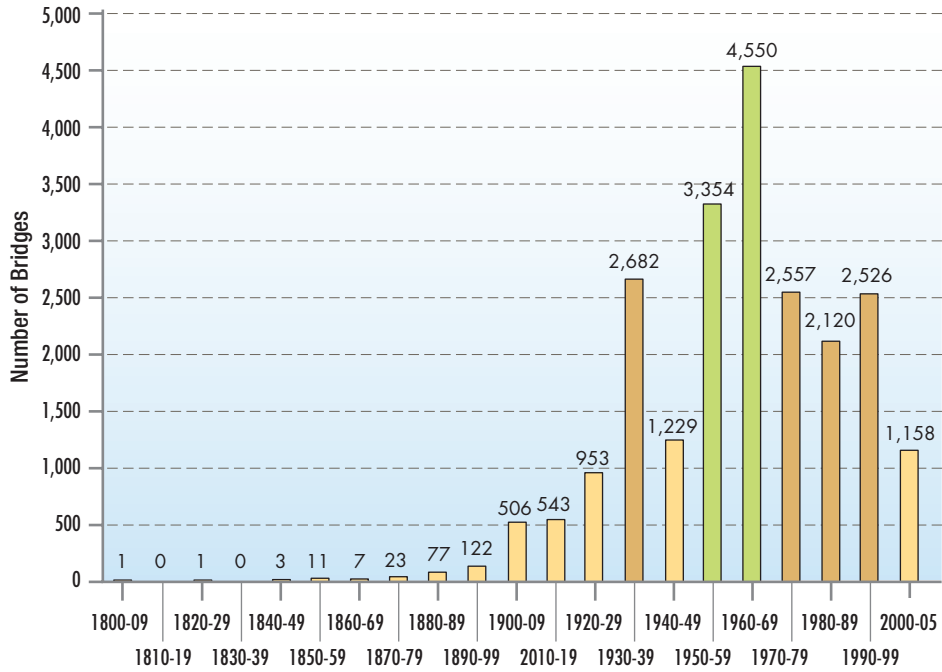

**Figure 2-3:**  
Distribution of Bridges by Year Built, New York State, 1800-2005

(SOURCE: TABULATED FROM THE FHWA, NATIONAL BRIDGE INVENTORY)

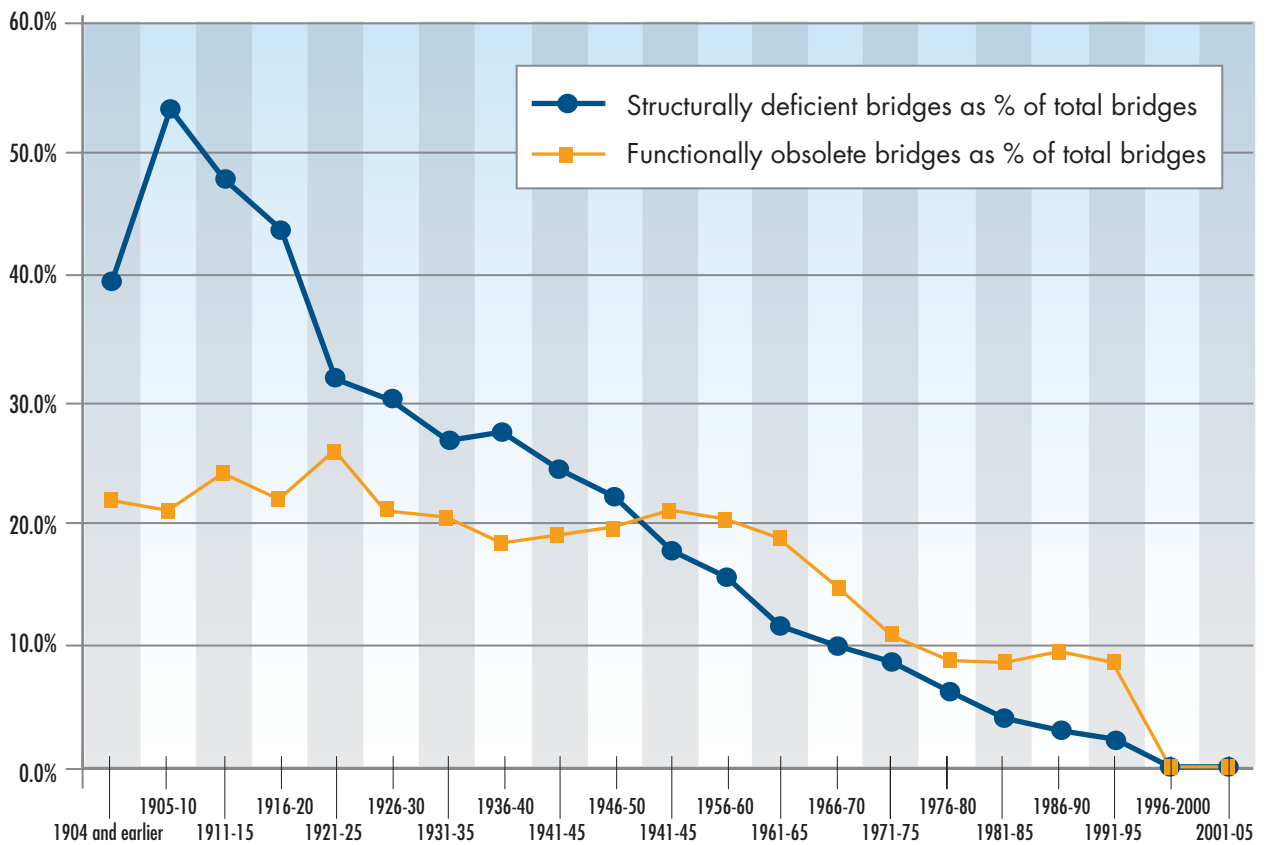
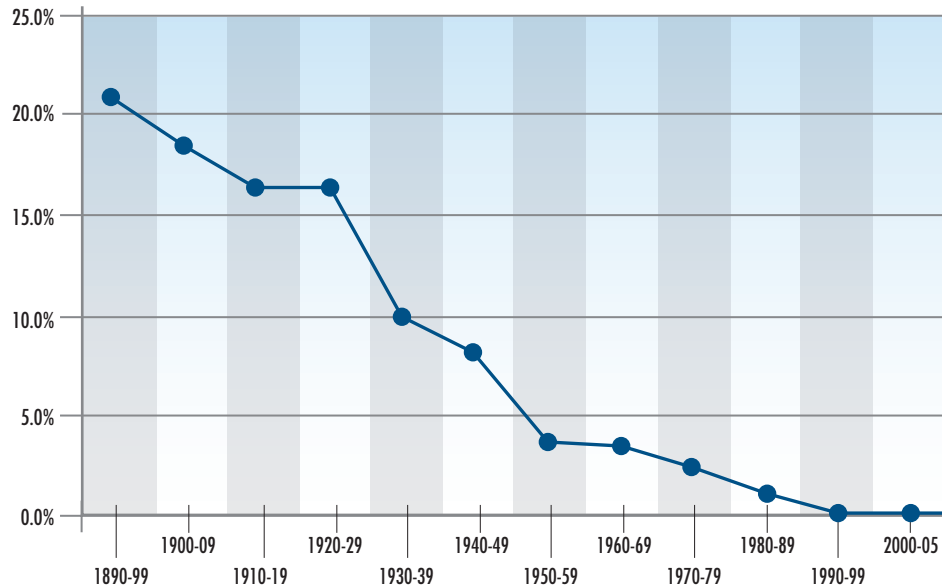

**Figure 2-4:**  
Number of Structurally Deficient and Obsolete Bridges in Each Time Period as a Percentage of the Number of Bridges Built in Each Time Period, New York State, 1800-2005

(SOURCE: GRAPHED FROM THE FHWA, NATIONAL BRIDGE INVENTORY)

**Figure 2-5:**  
Bridges with a Superstructure  
Condition Rating of Poor or  
Worse as a Percentage of  
Total Bridges Built in that Time  
Period, New York State

(SOURCE: GRAPHED FROM  
THE FHWA, NATIONAL BRIDGE  
INVENTORY)



### 2.2.3.5 Dams

Dams located in New York State are used here to illustrate some of the patterns with respect to age and hazard level as defined in the National Performance of Dams Program (NPDP). With over 1,970 dams, New York State ranks 14th among states in the country in terms of total number of dams and 15th in total maximum storage capacity of dams. Dams are assigned a hazard level, and hazard level is one aspect of a dam's overall condition.

The designated hazard level and the presence of an emergency action plan for dams are important in addressing vulnerabilities that may adversely affect the values for measures of consequences, such as fatalities and injuries and economic losses in case of a terrorist attack or a natural hazard.

Age may also be a factor to consider in prioritizing security and emergency action preparedness in the event of a terrorist attack or a natural hazard. However, the importance of age as a factor in vulnerability depends on maintenance and design, both of which are difficult to capture given data collected and available in data sets such as the National Performance of Dams Program (NPDP) database.

Descriptive statistics relating age of dams to hazard level in NYS reveal a pattern that suggests that hazard level increases with age, however, the role of other factors mentioned earlier needs to be kept in mind in interpreting these findings (Table 2-2).



**Three hazard levels are assigned to dams— high, significant, and low.**

High hazard dams are those that can cause loss of human life and serious damage to homes, properties, and infrastructure in the event of a failure. Significant hazard dams are those that may cause important damage to properties and infrastructure in the event of a failure. Low hazard dams are those that may cause damage to agricultural land and roads in the event of a failure.

**Table 2-2: Descriptive Statistics for Age of Dams by Hazard Level, New York State**

Hazard Level	Age						
	Mean	Median	Mode	Standard Deviation	N	Maximum	Minimum
High Hazard	81.0	84	97	35.8	375	209	8
Significant Hazard	75.9	79	99	34.3	694	221	9
Low Hazard	66.3	57	45	34.2	715	226	8

SOURCE: COMPUTED USING DATA FROM THE NATIONAL PERFORMANCE OF DAMS PROGRAM (NPDP) DATABASE.

Figures 2-6 to 2-9 show histograms of the number of dams in New York State by the year they were completed. Figure 2-6 shows the distribution of dams in the state by year built. Figure 2-7 shows the age distribution for high hazard dams, showing that a high number of them were built in the early 1900s. Figure 2-8 shows the age distribution for significant hazard dams and Figure 2-9 for low hazard dams. The age distributions are bimodal, with peaks for number of dams completed in the early 1900s and in the middle part of the second half of the 20th Century.

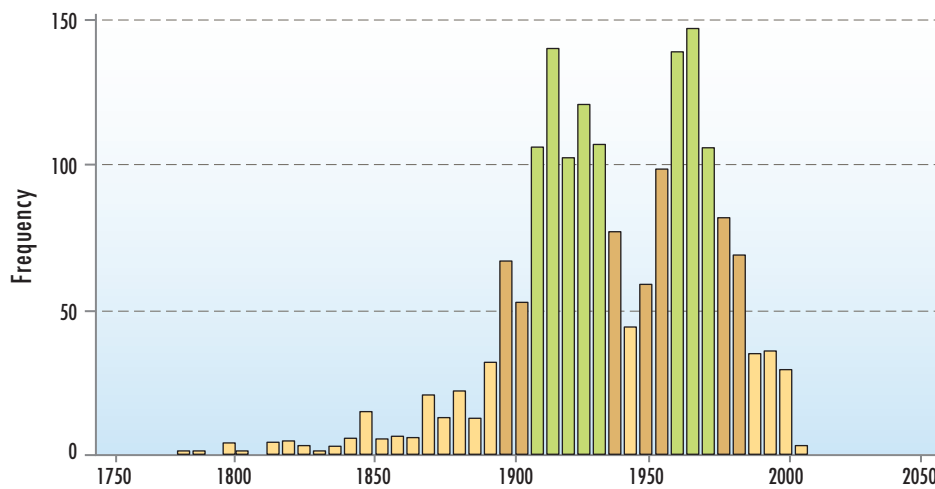
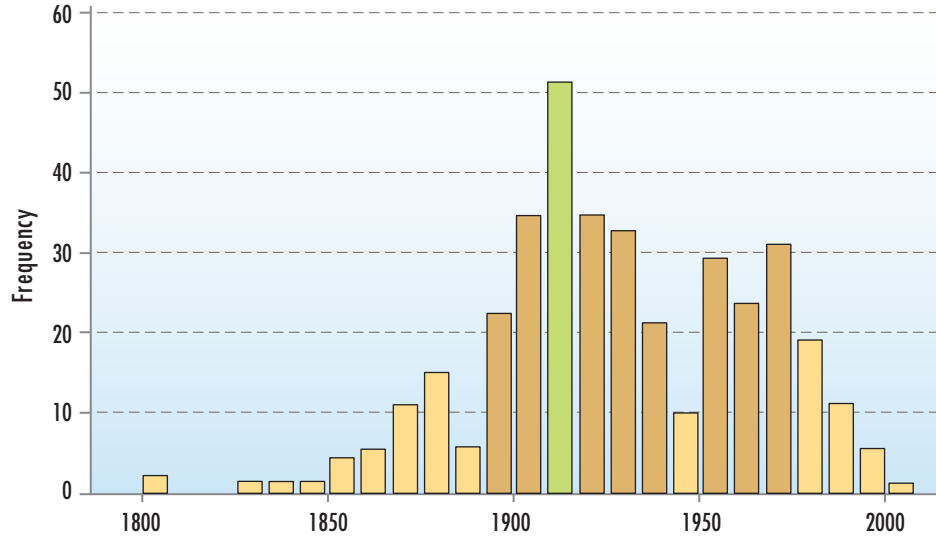

**Figure 2-6:**  
Histogram of number of dams by year built, New York State

(SOURCE: GRAPHED USING DATA FROM THE NATIONAL PERFORMANCE OF DAMS PROGRAM (NPDP) DATABASE)

**Figure 2-7:**  
Histogram of number of dams (N=375) by year built for high hazard dams, New York State

(SOURCE: GRAPHED USING DATA FROM THE NATIONAL PERFORMANCE OF DAMS PROGRAM (NPDP) DATABASE)



**Figure 2-8:**  
Histogram of number of dams (N=694) by year built for significant hazard dams

(SOURCE: GRAPHED USING DATA FROM THE NATIONAL PERFORMANCE OF DAMS PROGRAM (NPDP) DATABASE)

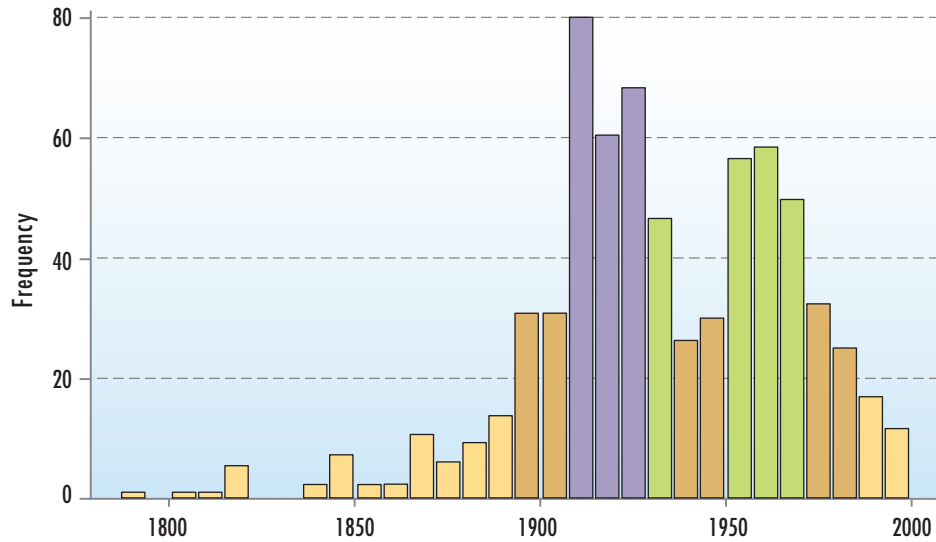

**Figure 2-9:**  
Histogram of number of dams (N=715) by year built for low hazard dams

(SOURCE: GRAPHED USING DATA FROM THE NATIONAL PERFORMANCE OF DAMS PROGRAM (NPDP) DATABASE)

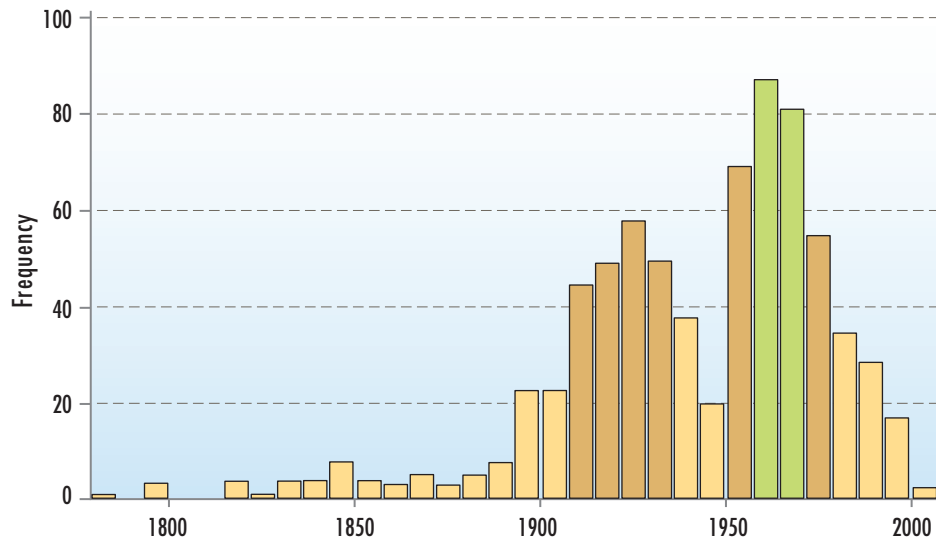

### 2.2.4 Conclusions

This paper covered energy infrastructure for oil and natural gas transport and electricity production, transportation infrastructure primarily with respect to bridges, and water-related infrastructure that also provides electric power—that of dams. First, it is apparent that although age may be available in very detailed inventories, consistent ways are needed of incorporating dates that rehabilitation and reconstruction occurred and ways of differentiating the age of different components of a given type of infrastructure. Second, what is apparent from the information presented above and from the literature is that the significance of age as a factor influencing infrastructure condition is different for different types of infrastructures, agencies, and objectives. Third, relationships identified between age and other infrastructure characteristics related to condition or performance are complicated by the many environmental stresses that infrastructure faces, especially in urban areas, and design practices that limit flexibility. Much of the new funding that is being targeted to infrastructure under the American Recovery and Reinvestment Act of 2009 (New York State 2009) is likely to address the age issue as well as needs for sustainability and security.



It is instructive to evaluate common patterns and trends across many different infrastructures to identify common themes with respect to the extent to which infrastructure age contributes to other problems and reduces the ability of the infrastructure to withstand stresses from extreme events.

### 2.2.5 Acknowledgements and Disclaimer

This research was supported by the United States Department of Homeland Security through the Center for Catastrophe Preparedness and Response at New York University, Grant number 2004-GTTX-0001, for the project “Public Infrastructure Support for Protective Emergency Services,” by the United States Department of Homeland Security through the Center for Risk and Economic Analysis of Terrorism Events (CREATE), Grant number 2007-ST-061-000001, and by the Institute for Information Infrastructure Protection (The I3P) under Award 2003-TK-TX-0003. However, any opinions, findings, and conclusions or recommendations in this document are those of the authors and do not necessarily reflect views of the United States Department of Homeland Security.

### 2.2.6 References

American Society of Civil Engineers (ASCE) (2009) *Report Card for America’s Infrastructure*. Washington, DC: ASCE. Available at <http://www.infrastructurereportcard.org/>.

Betz Converse Murdoch Inc. (1980) *New York City Water Supply Infrastructure Study Volume 1 Manhattan*. New York, NY: Department of the Army NY District Corps of Engineers.

Blake, E. S., Rappaport, E. N. and Landsea, C. W. (2007) *The Deadliest, Costliest, and Most Intense United States Tropical Cyclones from 1851 to 2006 (and other frequently requested hurricane facts)*. Miami, FL: National Weather Service, National Hurricane Center, April.

Cooper, M. (2009) *Old Water Pipes Becoming Hard to Ignore*, New York Times, April 18. <http://www.nytimes.com/2009/04/18/us/18water.html>. Energy Information Administration 2009.

New York State (2009) Federal Stimulus Spending Provisions That Impact New York. Available at <http://www.recovery.ny.gov/DirectAid/aidnewyork.htm>. Accessed April 18, 2009.

Office of Pipeline Safety (2008) *Pipeline basics*. Available online: <http://primis.phmsa.dot.gov/comm/PipelineBasics.htm>.

Rabinow, R. A. (2004) "The liquid pipeline industry in the United States: Where it's been where it's going. Available online: [http://www.aopl.org/posted/888/Final\\_Rabinow-pint\\_40804.57626.pdf](http://www.aopl.org/posted/888/Final_Rabinow-pint_40804.57626.pdf).

Restrepo, C. E., Simonoff, J. S. and Zimmerman, R. (2009) "Causes, Cost Consequences, and Risk Implications of Accidents in U.S. Hazardous Liquid Pipeline Infrastructure," *International Journal of Critical Infrastructure Protection*, 2, pp. 38-50.

Simonoff, J.S., Restrepo, C.E., and Zimmerman, R. (2009) "Risk Management of Cost Consequences in Natural Gas Transmission and Distribution Infrastructures," paper in preparation.

Simonoff, J.S., Restrepo, C.E., and Zimmerman, R. (2007) "Risk Management and Risk Analysis-Based Decision Tools for Attacks on Electric Power," *Risk Analysis*, Vol. 27, No. 3, pp. 547-570.

Simonoff, J.S., Restrepo, C.E., Zimmerman, R., and Naphtali, Z.S. (2008) "Analysis of Electrical Power and Oil and Gas Pipeline Failures," Chapter 27 in *Critical Infrastructure Protection*, edited by E.D. Goetz and S. Sheno, New York, NY: Springer, pp. 381-394.

U.S. EPA (2007) Aging Water Infrastructure Program. *Addressing the Challenge Through Innovation*, September. Washington, DC: U.S. EPA <http://www.epa.gov/nrmrl/pubs/600f07015/600f07015.pdf>.

U.S. EPA, Office of Water (2002) “The Clean Water and Drinking Water Infrastructure Gap Analysis,” Washington, DC: U.S. EPA, September. <http://www.epa.gov/safewater/gapreport.pdf>.

Zimmerman, R. (2008) “Managing Infrastructure Resiliency, Safety and Security,” Encyclopedia of Quantitative Risk Assessment and Analysis, edited by E. Melnick and B. Everitt. Chichester, UK: John Wiley & Sons, Ltd, pp. 1033-1040.

Zimmerman, R., Restrepo, C.E., and Simonoff, J.S. (2008) “Infrastructure Disruptions and Recovery Rates in Disasters,” ASCE Metropolitan Section Infrastructure Group Technical Seminar “New York City Infrastructure Critical Needs,” Brooklyn, NY: Polytechnic University of New York, March 24-25, pp. 28-35.

Zimmerman, R. and Restrepo, C.E. (2009) “Analyzing Cascading Effects within Infrastructure Sectors for Consequence Reduction.” IEEE International Conference on Technologies for Homeland Security, HST 2009, Waltham, MA.

Zimmerman, R. and Simonoff, J.S. (2009) “Transportation Density and Opportunities for Expediting Recovery to Promote Security,” Journal of Applied Security Research, Vol. 4, pp. 48-59.

## 2.3 The Impact of Aging Infrastructure on Security

*Harry A. Capers Jr., P.E.; Meghann M. Valeo*

### 2.3.1 Introduction

Reacting to the need for leadership in developing security standards and identifying resources, the American Association of State Highway and Transportation Officials (AASHTO) in conjunction with the Federal Highway Administration (FHWA) initiated several activities to address this knowledge gap. One was the formation of a Blue Ribbon Panel (BRP) on Bridge and Tunnel Security. This panel, working through a National Cooperative Highway Research Program (NCHRP) Project 20-59(3) “FHWA/AASHTO Blue Ribbon Panel on Bridge and Tunnel Security” was charged with two tasks. These were first to provide direction for a national security-related policy to guide the owners/operators of highway infrastructure and second to develop short- and long-term strategies for improving the safety and security of the Nation’s bridges and tunnels.

The panel conducted several meetings and made several site visits to identify and clarify the issues, develop and evaluate potential solutions, and formulate and refine recommendations for improving bridge and

tunnel security. While the group received many briefings on the subject it should be recognized that the material provided them was all open source material. That be as it may, the panel still was able to provide extremely valuable insights and recommendations from which to proceed. The first significant conclusion of the panel was that the threat to our transportation system was real. The panel concluded, “The success and safety of the system (during several historical events), and perceived number of parallel routes does not mean that transportation system is invulnerable to significant disruption by terrorist attack.” In fact the transportation system in the United States was already straining to meet demand in many places and many obvious choke points exist at major bridge crossing points and tunnels. The second major conclusion was that an attack upon a major bridge or tunnel could result in severe economic consequences and prove to be severely disruptive



One of the biggest challenges facing owners is determining what the threat to their assets is and understanding the

rate at which their structures are aging. Throughout the 1990s, terrorist attacks around the world demonstrated the creativity and determination of extremist organizations in their attacks against targets of interest. In terms of security, owners had a massive number of issues that needed to be answered, not the least of which was what national agency would assume the leadership role in developing security standards and where the resources would come from.

**INFRASTRUCTURE TYPE:** Bridges and tunnels



to regional and national economy. The panel concluded that the cost of replacement of a major river crossing and the economic loss to the economy was in tens of billions based on estimates from recent earthquakes.

Recently, there have been several instances of structural failure. Not all of these instances occurred due to terrorist attacks, but the damage incurred by the surrounding population had a serious impact on public perception of safety within the region. Aging infrastructure affects both security and performance of a transportation system. There are many rehabilitation techniques that can both reduce the rate of aging for a structure and in turn, improve the security of a network. Utilizing technology through structural health monitoring would undoubtedly improve the owner's ability to effectively analyze his transportation assets and allocate funds to the structures which are found most vulnerable.

### 2.3.2 How does Aging affect Security and Performance?

Recently, several disasters resulting from the nation's aging infrastructure have forced politicians as well as the public to pay greater attention to this issue. America's infrastructure was designed and built largely following World War II, which means it is at least 50-60 years old. Over the years, many of these structures have been neglected with respect to maintenance, making them either structurally deficient or functionally obsolete. By definition,<sup>1</sup> a bridge is classified as structurally deficient if there are significant load carrying elements found to be in poor or worse condition due to deterioration and/or damage or the adequacy of the waterway opening provided by the bridge is determined to be extremely insufficient to the point of causing intolerable traffic interruptions. A bridge is classified as functionally obsolete when it has deck geometry, load carrying capacity, clearance or approach roadway alignment that no longer meets the criteria for the system of which the bridge is a part. Also, Americans have been putting new demands on this aging infrastructure, forcing these structures to perform under conditions that weren't considered during design. Aging infrastructure poses a large security risk to the American public. As it becomes apparent (through recent failures) that our infrastructure is already fragile, it makes it easier for terrorist groups and adversaries to exploit our vulnerabilities.

#### 2.3.2.1 Metrics for Aging

In the area of bridges, bi-annual inspections are the primary means of evaluation of structures. Following the collapse of the Silver Bridge (U.S.

---

1 Bridge Inspector's Reference Manual," Prepared by the National Highway Institute for US Department of Transportation and the Federal Highway Administration. Publication No. FHWA NHI-03-001, October 2002, Revised December 2006.

Route 35 over the Ohio River, which connected Ohio and West Virginia) on December 15, 1967 the Federal Highway Administration (FHWA) established the National Bridge Inspection Program, which requires that every bridge (longer than 20 ft) be inspected at least once every two years. The common metric then becomes the sufficiency rating (Figure 2-10), load posting, and categorization of a bridge as Functionally Obsolete or Structurally Deficient. These sufficiency rating numbers have served as the primary measurement in the determination of how bridges are programmed by owners for repair/rehabilitation or replacement.

Recently, the effectiveness of the current bridge inspection program has been heavily scrutinized since it is largely based on visual inspections conducted by technicians rather than licensed professional engineers. It is



Recently, the effectiveness of the current bridge inspection program has been heavily scrutinized

since it is largely based on visual inspections conducted by technicians rather than licensed professional engineers. It is not feasible to use licensed professional engineers to perform all visual bridge inspections due to the growing shortages of civil engineers.

not feasible to use licensed professional engineers to perform all visual bridge inspections due to the growing shortages of civil engineers. In 2007, the FHWA sponsored a scan titled “Bridge Evaluation Quality Assurance” where 10 industry leaders traveled across Europe to study bridge inspection practices specifically targeting Quality Assurance. The team found that, overall, the reference materials used in European countries were very detailed and more heavily illustrated than the manuals used in the United States. Finland also had a unique approach to ensuring quality inspections. The Finnish Road Administration (FINNRA) uses a sampling of 106 bridges and 26 steel culverts as a control sample, or reference bridges. Baseline data is collected for these bridges/structures by experienced in-house bridge inspectors to provide consistency.

The long-term benefits of this data include using this data to conduct trend analysis of data and updating deterioration models, quality control of inspection data from non-reference bridges since there is a baseline for comparison, and the availability of training and refresher training of Inspectors and evaluation of Inspector ratings against condition ratings provided by in-house staff and field inspectors.

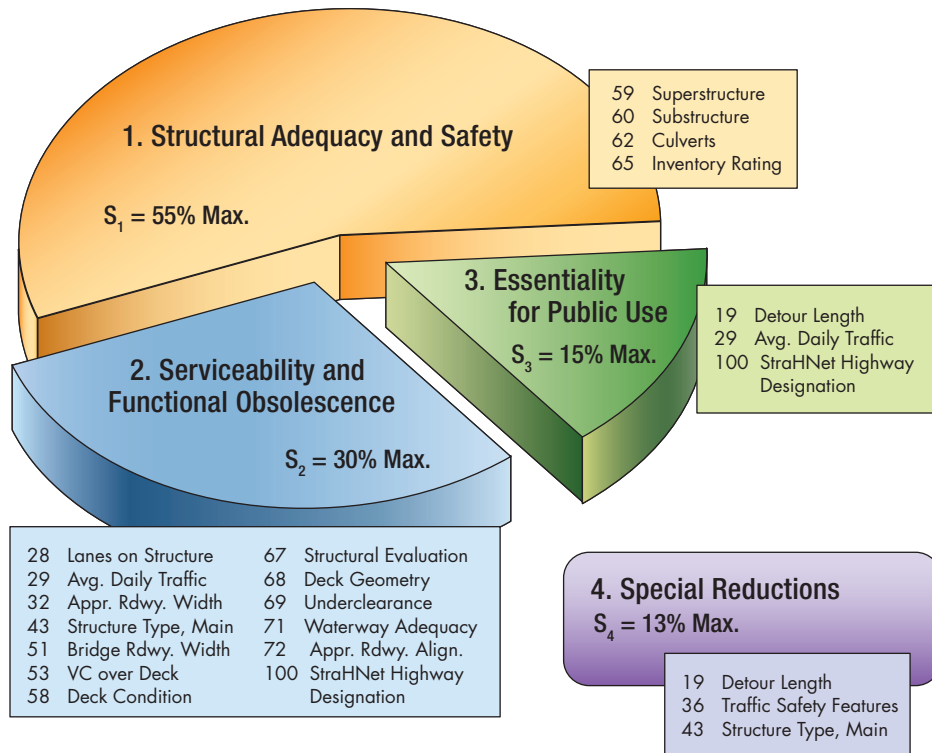

Figure 2-10: Summary of Sufficiency Rating Factors

**Sufficiency Rating = S<sub>1</sub> + S<sub>2</sub> + S<sub>3</sub> - S<sub>4</sub>**  
 Sufficiency rating shall not be less than 0% nor greater than 100%

It was not until the 1990s that some agencies began implementing investment strategies through asset management techniques for bridge investments. As part of the NCHRP Report 525: Surface Transportation Security, a new fifteenth volume titled “Costing Asset Protection: An All Hazards Guide for Transportation Agencies (CAPTA)” has been developed. The goal of this publication is to provide transportation owners and operators with resource allocation guidelines for safety and security investments. CAPTA<sup>2</sup> provides transportation owners the methodology with which to consider multiple modes within their jurisdiction and to more effectively allocate resources than through the typical capital allocation process.

As the list of consequences associated with the loss of a critical asset increase, the criticality of that asset also increases. The key difference between the CAPTA process and previous assessment tools is that it does not require the user to estimate the variable of “likelihood.” In order to estimate the parameter of likelihood, it would be necessary for owners

2 Costing Asset Protection: An All Hazards Guide for Transportation Agencies (CAPTA)  
 Prepared for the National Cooperative Highway Research Program, NCHRP Report 525:  
 Surface Transportation Security, Volume 15, 2009.

The CAPTA process is a consequence-based methodology, which also attempts to achieve greater objectivity in resource allocation through the use of asset attributes versus simply judgment. In this context, consequence is defined as “the loss or degradation of use of an asset resulting from a threat or hazard.” There is a distinct correlation between criticality and the total number of consequences associated with a particular asset.

to have current threat intelligence. It seems more effective from an owner’s perspective to look at the big picture and allocate resources where, if an attack or failure occurs, consequences of risk are minimized, rather than making assumptions based on the likelihood of a specific threat.

Many people automatically associate security with acts of terrorism. Security, as it relates to transportation encompasses terrorism, however, also includes natural disasters and the failure of aging structures. Figure 2-11, from Volume 15 of the NCHRP Report 525: Surface Transportation Security shows the taxonomy of threats and hazards for multi-modal transportation systems.

ards for multi-modal transportation systems.

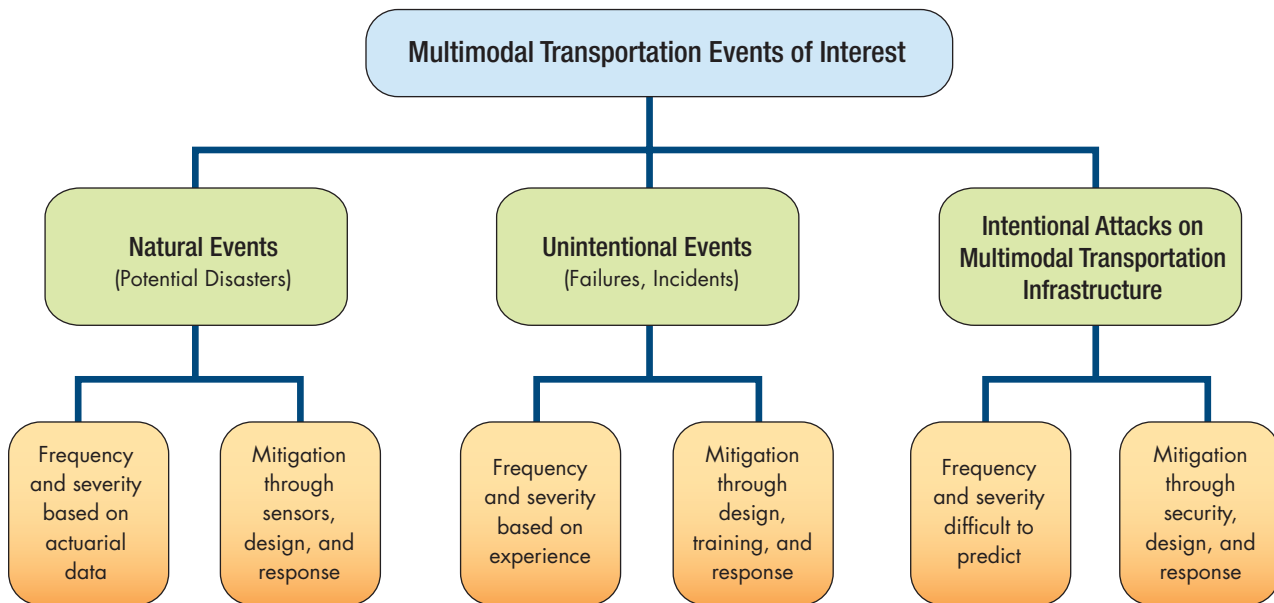

Figure 2-11: Threats and Hazards for Multi-Modal Transportation Systems

The proximity of aging infrastructure to key assets (i.e., ports, power plants, military facilities) has an impact on the overall security of the network. The collapse of a structure not only negatively affects traffic on that road, but also traffic along nearby roads and bridges. Especially important in densely populated and developed areas such as the New York Metropolitan area, the failure of a bridge leading to the port could have catastrophic economic effects in an already unstable economy. Vulnerability assessments are simple to conduct on an isolated structure; however, it is also necessary to consider the surroundings in order to adequately categorize the importance of the structure. A bridge may not be classified as important on its own, but when you add in the fact that it is part of a coastal evacuation route, it suddenly raises the importance of the structure. The “Guide to Highway Vulnerability Assessment for Critical Asset Identification and Protection” was prepared under NCHRP Project 20-07/Task 151B, as a tool for owners to assess the vulnerabilities of their assets, develop countermeasures to deter, detect, and defend against threats, and to estimate the capital and operating costs of such countermeasures.

It is important to consider the cultural and historical significance of aging infrastructure as it relates to security. There are many bridges, monuments, and buildings across the nation that could be classified as historically significant. This classification increases the vulnerability of a structure without any other factors being considered due to the potentially negative effect on morale as a result of its loss. In terms of attractiveness, terrorists seek out targets that will disrupt the public’s perception of safety and security, produce a large number of casualties, and a high amount of collateral damage. Providing safety and security countermeasures for these types of structures is especially challenging, as it needs to be subtle, economical, and effective.

### 2.3.3 Rehabilitation/Replacement of Aging Infrastructure

As of 2008, according to the Bureau of Transportation Statistics,<sup>3</sup> there are approximately 71,500 bridges (total of 601,400 bridges) across the United States classified as structurally deficient. Once a bridge is classified as structurally deficient, it is a requirement for the owner to either replace or rehabilitate the structure. Above and beyond the obvious problems associated with being classified as functionally obsolete, this also causes added congestion therefore impeding security response. During rehabilitation, it is necessary to examine the feasibility of enhancing and improving the overall security of the structure.

As bridges age, it is common for owners to post bridges for load limits and/or adjust the posted clearance of a structure. While these limits are imposed with public safety in mind, it is important to note that these limits cause impediments to mobility and could therefore impede emergency response capabilities. In addition to the potential degradation of emergency response capability, a region could experience negative

<sup>3</sup> Bureau of Transportation Statistics Website: [www.bts.gov](http://www.bts.gov).

economic effects due to the inability of vehicles to traverse a certain route. These impacts are a threat to the security of the region because it makes an otherwise benign target significantly more attractive to the adversary. For this reason, careful consideration of the entire network is important for the owners to understand the impacts of implementing the imposed load restrictions.



There are three different categories of security countermeasures:

### Deterrence • Detection • Defence

Effective security countermeasure plans incorporate aspects of each measure.

As defined in the National Cooperative Highway Research Program (NCHRP) Project 20-07/Task 151B, “A Guide to Highway Vulnerability Assessment for Critical Asset Identification and Protection,” there are three different categories of security countermeasures:

**Deterrence**— A potential aggressor who perceives a risk of being caught may be deterred from attacking an asset. The effectiveness of deterrence varies with the aggressor’s sophistication, the asset’s attractiveness, and the aggressor’s objective.

**Detection**— Detection senses an act of aggression, assesses the validity of the detection, and communicates the appropriate information to a response force. A detection system must provide all three of these capabilities to be effective.

**Defense**— Defensive measures protect an asset from aggression by delaying or preventing an aggressor’s movement toward the asset or by shielding the asset from weapons and explosives. Defensive measures: (1) delay aggressors from gaining access by using tools in a forced entry, (2) prevent an aggressor’s movement toward an asset, and (3) protect the asset from the effects of tools, weapons, and explosives.

Effective security countermeasure plans incorporate aspects of each of the above. The determination of which countermeasures are appropriate

The determination of which countermeasures are appropriate for a specific project requires collaboration between the owner, the designer and law enforcement or security personnel.

for a specific project requires collaboration between the owner, the designer and law enforcement or security personnel. The owner will ultimately be responsible for maintenance of the new or rehabilitated structure once completed, which makes him a key stakeholder in the development of security countermeasures. There are a variety of commonly used countermeasures, which could be considered during the rehabilitation or replacement of bridges.

### 2.3.3.1 Standoff Distance

Restrict parking under a bridge structure. This can be done through the use of concrete barriers. Barriers should be placed to also restrict parking adjacent to a bridge structure. Free space under a bridge structure is viewed by many as a valuable commodity for not just parking but also such activities as, storage, placement of small structures and even waste disposal. While some activities, such as recreational use may be acceptable and in some cases even necessary as part of a project need, control of the use is essential to ensure access does not provide an opportunity for adversaries to attack the structure. Some sort of access and usage control, such as security fencing, should be incorporated into design when such usage is considered.

### 2.3.3.2 Visibility

Restrict the placement of vegetation that would obstruct surveillance measures. This may not be a very attractive countermeasure for the stakeholders developing project aesthetics; however, it is a very important action to consider. Landscaping can intentionally or unintentionally obscure the view of bridge elements and provide natural concealment for someone trying to access the substructure by obscuring key bridge elements from view of passing patrols. Highway structures other than bridges should also be considered as potential targets since the consequence of their loss would mean reduced mobility.

### 2.3.3.3 Technology

Detail the installation of surveillance cameras that can be tied to an agencies operations center or law enforcement command center. As intelligent transportation systems (ITS) and traffic operations centers become more sophisticated, it will become easier to take advantage of real time video surveillance of our highway facilities using cameras. Cameras can be positioned to allow surveillance of both traffic operations and key structural components.

### 2.3.3.4 Improved Lighting

Detail the installation of lighting throughout a bridge structure to ensure surveillance. This should include lighting under a bridge that is located over a waterway. Again, building on the idea that surveillance is of the utmost importance, proper lighting must be provided to allow visibility of the elements of interest on a bridge in low light conditions. The type of lighting provided should consider the needs of surveillance cameras if they are employed as part of the countermeasure plan.

### 2.3.3.5 Reduce Accessibility to Key Structural Elements

Detail, to the greatest extent possible, all bridge components so that no component is concealed from view. Aesthetic treatment of a bridge can be done in such a fashion as not to obscure any load carrying members. Designers should try not to provide convenient places, such as notches and pockets, to place explosives or other dangerous materials. It is quite common for bridge seats to have readily accessible areas to place dangerous materials. The amount of accessible areas could be reduced by placing more concrete in between stringers or by the use of integral abutments. Another possibility is to make the bridge seat as inaccessible as possible to deter attacks, however, the designer needs to consider future bridge inspections. The use of flammable materials and coatings for structural or aesthetic purposes should be avoided. Drainage should not be embedded in structural components or discharge under the structure to avoid the packing of explosive materials in the structure or discharging flammables under it.



It is crucial for designers to prohibit the use of non-redundant members.

The use of non-redundant members simply makes a deliberate attack to destroy a structure that much simpler.

### 2.3.3.6 Redundancy

It is crucial for designers to prohibit the use of non-redundant members. The use of non-redundant members simply makes a deliberate attack to destroy a structure that much simpler. In most cases, bridge engineers already avoid these types of designs. Security considerations simply add another argument against the use of non-redundant details. Designers should follow the load path all the way to the founding material when checking for such details

to ensure the loss of one element does not result in the loss of the entire structure. Redundancy also applies when considering the availability of fully functional routes within a transportation network. For example, if there is only one feasible route for freight to travel within a network, then if a piece of that network is destroyed the security for the entire network is degraded.

The maintenance of critical infrastructure is vital with respect to increasing the lifetime of a structure. In many cases, periodic maintenance is neglected due to insufficient funds and the need to prioritize repairs of structures that are classified in worse condition. In terms of security and economics, it makes sense to invest in periodic maintenance of bridges rather than wait until the sufficiency rating requires action. The graph displayed in Figure 2-12, shows the cost of renovation after there is a 40% drop in quality, and then the cost of the same renovation if it were delayed until there was an 80% drop in quality.



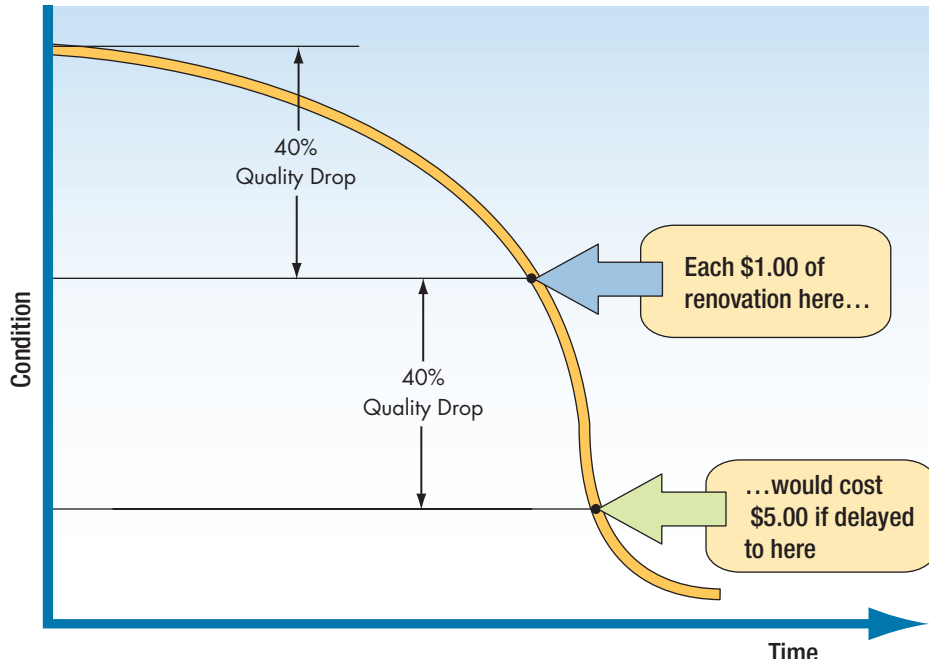

Figure 2-12:  
Relationship between  
Maintenance, Condition, and  
Time

In this case, it shows that by postponing necessary maintenance, the cost of the same renovation is approximately five times what it would have been if it was fixed earlier in the life of the structure. As stated previously, as a structure ages, it becomes more vulnerable and has a negative impact on security. Therefore, it could be concluded that investing money in timely bridge maintenance could improve the overall security of a region, because the rate at which aging occurs would be decreased.

### 2.3.4 Conclusion

Aging infrastructure affects both security and performance of the transportation system. Currently, the common metric is the sufficiency rating, load posting, and categorization of a bridge as Functionally Obsolete or Structurally Deficient. These sufficiency rating numbers have served as the primary measurement in the determination of how bridges are programmed by owners for repair/rehabilitation or replacement. In the future, it may benefit owners to look at some of the common Quality Assurance practices used in European countries in order to strengthen the effectiveness of the current bridge inspection program in the United States. The implementation of sensors and the use of technology also need to be explored, as this provides the owner with the data necessary to more effectively analyze bridges and monitor the performance of a structure throughout the entire lifetime of the bridge.

Once a bridge is found to be structurally deficient and/or functionally obsolete, there are many rehabilitation techniques that can be implemented which repair structural shortcomings as well as improve the overall security of the bridge and roadway network. These repairs have a positive effect on reducing the vulnerability of a structure; however, the amount at which the vulnerability is reduced is a subjective figure.

Recently, the CAPTA tool has been made available to owners, which is a consequence based approach to prioritizing funds for transportation assets. Using this tool, owners can make fiscal decisions based on the impact to the system of losing a particular transportation asset, not simply based on subjective opinions on the likelihood of a particular method of attack. In a world where the adversary changes his tactics daily, this is a much more effective method of analysis for owners to use.

## 2.4 A Bridge to Prosperity: Resilient Infrastructure Makes a Resilient Nation

*Mitchell D. Erickson, Ph.D. \**

### 2.4.1 Introduction

**T**o achieve the vision of a resilient America, we must commit to a sustained effort across geographic, political, and economic boundaries, across infrastructure sectors, and across technical discipline. Simultaneously the vision must acknowledge our investment in existing structures, increase America's resiliency, reap the benefits of improved societal efficiencies, and strengthen America on the world stage. Simply patching potholes, painting bridges, building power plants, adding lanes to interstates, and propping up utility poles are insufficient and unacceptable piecemeal solutions. More important, science and technology can contribute to shaping our blueprint by instilling scientific rigor into the process that will shape our future

We must develop and implement technologies, processes, standards, codes, and laws that enable the vision. But, before we commit precious resources, we need a blueprint at multiple scales, requiring a national discourse on priorities and technological assessments that provide solid, compelling evidence for a positive cost/benefit ratio.

S&T's role in understanding interdependencies at multiple scales, setting standards, examining underlying assumptions, informing decisions with data, envisioning possible future technologies, developing architectures,

improving risk assessment, analyzing alternatives, and running scenarios is critical to optimize and rationalize the vision. S&T can also contribute to initiatives to provide 21st century governance, financing, manufacturing, and business models.

Scientists and engineers have a voice and an important role in shaping this vision. The science and technology community must participate in the discourse and provide guidance on the technical, economic, and social possibilities for our future.

### 2.4.2 Our Aging Infrastructure

Infrastructure ages. Priorities change. Disasters, accidents, and catastrophes occur. Nonetheless, in the face of these forces, America must maintain its infrastructure. A balanced replacement/renovation plan and program would maintain our infrastructure at an acceptable target average age while shifting toward projected capacities and demands.

America has deferred needed maintenance for many years, the infrastructure is aging, and we are beginning to suffer the consequences. The American Society of Civil Engineers (ASCE) estimated<sup>4</sup> in 2009 that the US has \$2.2 trillion in deferred maintenance, repairs, and needed infrastructure upgrades. Our investment in transportation has not kept pace with demand. Highways are one example, as shown in Figure 2-13.<sup>5</sup>



As America seeks to revitalize its aging infrastructure through both renovation and new construction, it must develop a long-term vision. Traditionally, science and technology have provided a toolbox of new technologies, new materials, new monitoring, better controls, and optimization models. The Department of Homeland Security's (DHS's) Science and Technology Directorate (S&T) will continue to shape the discussion of how we achieve a resilient infrastructure. Intelligent revitalization and expansion of America's infrastructure requires innovation on many physical scales, from the nano- to the global. This paper addresses the scope and scale of the challenges and explores considerations for developing plans.

**INFRASTRUCTURE TYPE:** ALL

<sup>4</sup> American Society of Civil Engineers Report Card for America's Infrastructure, 2009.

<sup>5</sup> Federal Highway Administration Relationships Between Asset Management and Travel Demand, Chapter 2, Oct. 15, 2008

**Figure 2-13:**  
Growth of population, GDP,  
vehicles, and total highway  
lane-miles

[HTTP://WWW.FHWA.DOT.GOV/  
INFRASTRUCTURE/ASSTMGMT/  
VMTEXES.CFM#EX0202.](http://www.fhwa.dot.gov/infrastructure/asstmgmt/vmtexes.cfm#EX0202)

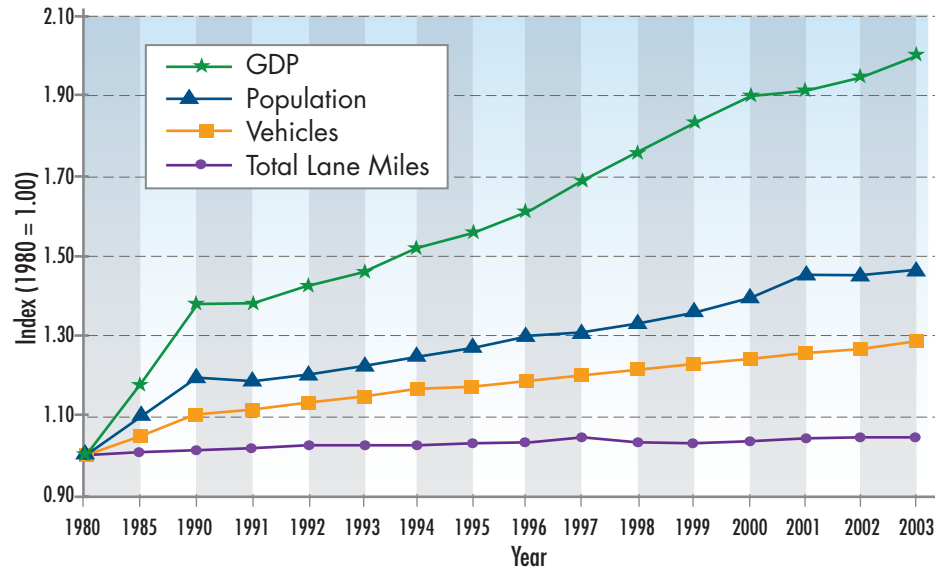

Despite compelling data from ASCE, various governmental organizations, and many others, we continue to slip further behind.

While the decline is troubling, we face other challenges in growth:

- Vehicle traffic is growing at 1.4 percent per year.
- Transit ridership in New York grew 3 percent in 2008.
- 2035 will see 80 percent more freight.
- By 2020, the number of shipping containers handled will double.<sup>6</sup>

Moreover, societal changes will present challenges:

- Electric vehicles will force changes in the way we finance highways. As fewer vehicles use petroleum, how will we replace the gasoline tax?
- As Americans age, and our activity patterns change, the infrastructure demands will change.
- Population is migrating to the coasts;<sup>7</sup> coastal counties constitute only 17 percent of the total land area of the United States

<sup>6</sup> Stanley Gee, Acting Commissioner, NY State Department of Transportation, Keynote Address to The New York State Infrastructure Summit, NY, NY, 12 May 2009.

<sup>7</sup> Deborah Epstein Popper and Frank J. Popper, *The Great Plains: From Dust to Dust, Planning* (December 1987). The "Buffalo Commons" asserted that human population of the U.S. high plains was unsustainable, that people would continue to migrate away toward population centers, and that a large swath of America's midlands should be returned to a vast nature preserve. The concept was not well-received in the affected region.

(not including Alaska) but account for fully 53 percent of the total population, and that figure is rising.<sup>8</sup>

Information technology will change our habits and locations for work, shopping, recreation, and communications. These changes will affect demand on telecommunications, shipping, and movement of people in ways we cannot reliably predict.

“*We need to fix the way we fix things.*”<sup>9</sup> America and many other countries have responded to the economic crises of 2008–2009 with stimulus packages that, among other goals, fund infrastructure. In many cases, the funding is designed to create jobs by funding “shovel ready” projects that have already been planned. These near-term fixes are needed, given the circumstances, but as America revitalizes its aging infrastructure through both renovations and new construction, we must develop a long-term vision. The vision must simultaneously maintain existing structures, increase America’s resiliency, reap the benefits of improved societal efficiencies, and strengthen America on the world stage. The Dwight D. Eisenhower National System of Interstate and Defense Highways, now more than 50 years old, is a premier example of a bold, national vision. Simply patching potholes, painting bridges, building power plants, adding lanes to interstates, and propping up utility poles is insufficient and

Every year public- and private-sector organizations spend hundreds of billions of dollars to operate and maintain power, drinking water, waste water, transportation, and telecommunications systems. At least \$285 billion was invested in these efforts in 2004 alone. Nonetheless, this was inadequate, as evidenced by the deteriorating condition of these systems. The resources available to renew and restructure these systems will be limited for the foreseeable future, and hard investment choices will need to be made.

Ensuring the resilience of our critical infrastructure is vital to homeland security. Working with the private sector and government partners at all levels will develop an effective, holistic, critical infrastructure protection and resiliency plan that centers on investments in business, technology, civil society, government, and education. We will invest in our Nation’s most pressing short and long-term infrastructure needs, including modernizing our electrical grid; upgrading our highway, rail, maritime, and aviation infrastructure; enhancing security within our chemical and nuclear sectors; and safeguarding the public transportation systems that Americans use every day.

unacceptable.

President Obama’s administration is committed to resilient infrastructure:

<sup>8</sup> Kristen M. Crossett, Thomas J. Culliton, Peter C. Wiley, and Timothy R. Goodspeed, *Population Trends Along the Coastal United States: 1980–2008*, National Oceanic and Atmospheric Administration, NOAA’s National Ocean Service, September 2004.

<sup>9</sup> Rob Puentes (Brookings Institution) at a rollout event for *Memo to the President: Invest in Infrastructure for Long-Term Prosperity*, Brookings Institution, Washington, DC, 12 January 2009.

Science and technology provide a toolbox of new technologies, new materials, new monitoring, better controls, integration of systems, and optimization models. These advances will shape the discussion on how we achieve a resilient infrastructure.

This paper discusses the need for and benefits of working toward resilient infrastructure by discussing broad concepts and specific examples.

### 2.4.3 Homeland Security Benefits of a Resilient Infrastructure

Resiliency is the foundation of preparedness. A resilient society can withstand and/or recover from natural disasters, terrorist attacks, and infrastructure failures. A resilient society can face the challenges of the upcoming decades. Resiliency goes hand-in-hand with capacity. As we improve our resiliency, we simultaneously improve reserve capacity and can design for future demand. Resiliency is a core component of quality of life, prosperity, competitiveness, and security.

The benefits of resiliency are illustrated in Figure 2-14,<sup>10</sup> where a combination of hardening, redundancy, response time, and rate of recovery combine to define the integrated area or loss. Resiliency can optimize some or all of these components to minimize the loss.

Figure 2-14:  
Resilience dramatically reduces  
loss following a disaster

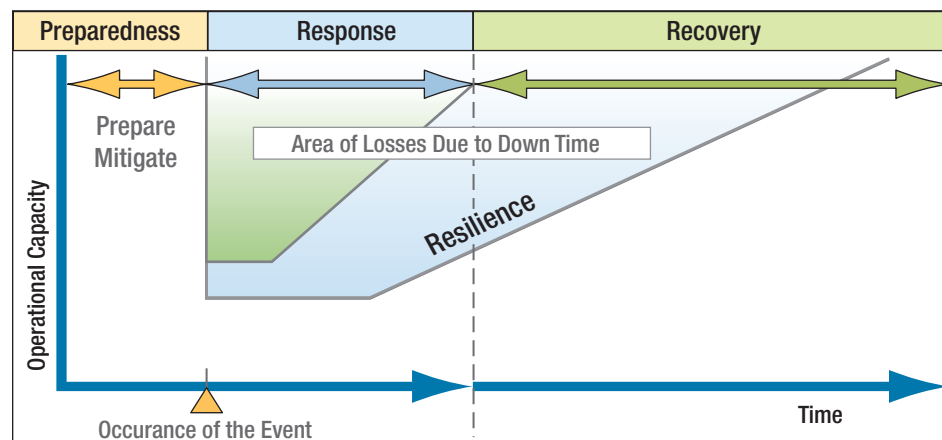

Society's investment priorities must satisfy broad sectors of the population as potholes are fixed, transportation is improved, life's amenities become more reliable, and costs are reduced. That is the small view.

The big view envisions a strong America that capitalizes upon our knowledge and service strengths to contribute to the global economy, has robust internal defenses, and continues to be a major force in the world.

<sup>10</sup> Adapted from personal communication, ME Hynes, DHS Science and Technology Directorate (S&T), originally conceived 12 September 2001

The vision should be: America will incorporate a resiliency ethic into construction, infrastructure, business models, and government policies. The objective is to increase America's resiliency and reap the benefits of improved societal efficiencies and a strengthened America on the world stage.

**Costs of Resiliency.** Infrastructure costs money. Resilient infrastructure may have a higher capital cost because it requires added safety factors, extra reserve capacity, redundant systems, backup operators, and other costs.

**Costs if we do not rise to this challenge.** If America's infrastructure is not resilient, if we continue to defer maintenance, if we cannot meet the coming societal and business demands, if we cannot efficiently transport people and goods, if we cannot communicate effectively, and if we try to run America on a shoddy infrastructure, we are doomed to a downward spiral in our economy, standard of living, and world stature.

The hidden costs of lost time and productivity, excess pollution, and general ill-will are incalculable. From our own personal experience, we all know the psychic and disruptive toll exacted by slow traffic, delayed deliveries, power outages, and poor phone connectivity. These are inconvenient annoyances. New Orleans suffered mightily through Hurricane Katrina, and in the years after, America needs to ponder the implications of a broken infrastructure, like New Orleans, with sporadic power, unsanitary conditions, constipated transportation, and intermittent food delivery.

Thinking across vast differences of scale. Scientists and engineers tend to work in reasonably tight-scale domains. Synthetic chemists think at a molecular scale. Physicists study subatomic particles. Engineers build structures in the 10- and 100-m scale. Transportation planners look for routes that are hundreds of kilometers long. Computer scientists design for nanosecond pulses. Increasingly we all need to be thinking and planning across all these scales. Scientists must visit other scales to consider implications of their work and look for new approaches. Engineers must think more broadly across scales to consider chemical degradation of structural elements and also the systems of systems that have an impact upon, and are impacted by, the discrete structure being considered.

## 2.4.4 A Roadmap to Resiliency

To achieve the vision of a resilient America, we must commit to a sustained effort across geographic, political, economic, infrastructure sector, and presidential administration boundaries. We must evolve our thinking, investment strategies, and infrastructure to a vision of a strong, resilient America in a complex, dynamic global economy and global society. We

must summon the political and social will to pass the laws and appropriations to effect change. But before we commit to this course, we need a blueprint, one whose details will require a national debate on priorities, studies to project cost/benefit ratios, and a consensus among a broad cross-section of politicians, corporate executives, civil servants educators, and—most importantly—citizens.

Leadership at the highest levels is required. A vision not unlike Eisenhower’s for the Interstate Highway System is required. At the same time, practitioners need to rethink their roles and contribute to the long-term vision through redefining our roles, designing for multiple uses, balancing retrofits and new construction, and approaching our professions through new paradigms.

**Redefining the Roles of our Disciplines.** A recent article in a trade magazine makes an impassioned plea for better integration of engineers into the overall homeland security critical infrastructure protection architecture<sup>11</sup> as shown in Figure 2-15. While this plea goes a long way toward exhorting engineers to think more broadly about their role in infrastructure resiliency, it does not go far enough, especially in the areas of protecting all four threat categories.

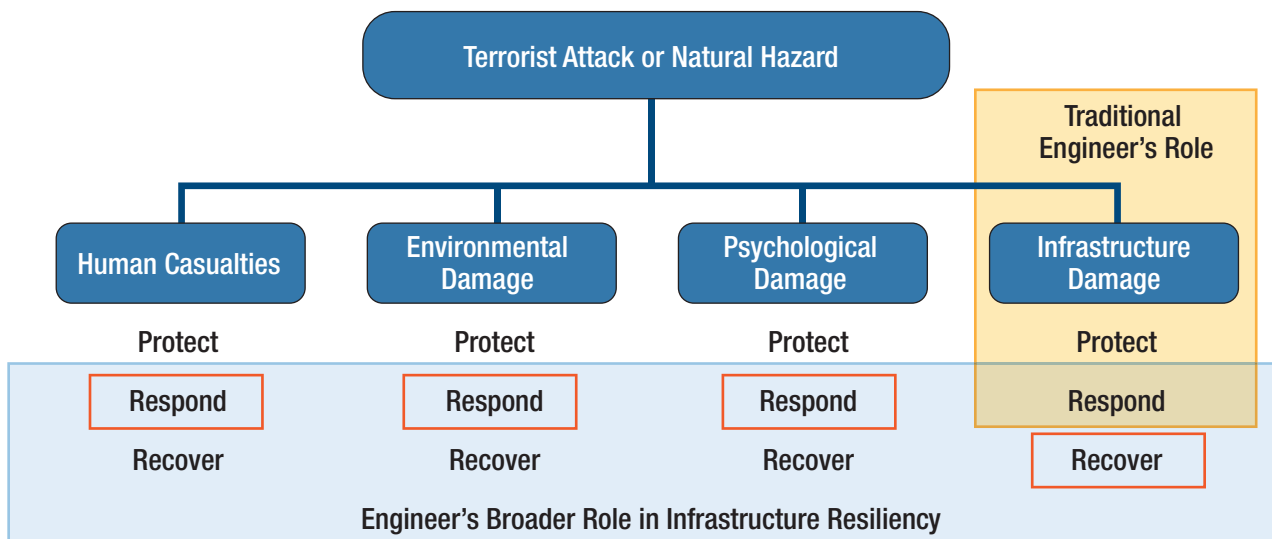

Figure 2-15: Expanding roles for Resiliency

In addition to just thinking more globally about our disciplines, there are techniques to guide us toward optimal professional behavior.

<sup>11</sup> Paul Serluco, Critical Infrastructure—Transportation: Engineers’ involvement in disaster preparedness planning is critical to success of resilient infrastructure. *Homeland Defense Journal*, November 2007, pp. 34–37.



**Assessing Trends and Initiatives.** An emerging technique for assessing new trends and initiatives is Positive Deviance.<sup>12</sup> This is an approach to personal, organizational, and cultural change based on the idea that every community or group of people performing a similar function has certain individuals (the “positive deviants”) whose special attitudes, practices, strategies, and behaviors enable them to function more effectively than others with the exact same resources and conditions. Because positive deviants derive their extraordinary capabilities from the identical environmental conditions as those around them, but are not constrained by conventional wisdoms, positive deviants’ standards for attitudes, thinking and behavior are readily accepted as the foundation for profound organizational and cultural change. In practice, this change includes methodologies and technologies for:

- quickly identifying the positive deviants,
- efficiently gathering and organizing the positive deviant knowledge,
- motivating a willingness in others to adopt the positive deviant approaches,
- sustaining the change by others by integrating it into their pre-existing emotional and cognitive functions, and
- scaling the positive deviant knowledge to large numbers of people simultaneously.

Therefore, the general idea is to identify the cohorts who “get it” and do the right thing, then, amplify this positive deviance.

There are stunning recent examples of this kind of thinking and subsequent action. General Russel Honoré was responsible for coordinating military relief efforts for Hurricane Katrina-affected areas across the Gulf Coast.<sup>13</sup> His positive deviance is credited with turning around the response efforts after prior failures. His direct, hands-on management style created great visuals as he directed soldiers to put down their weapons and focus on the rescue mission. Honoré made headlines nationwide when he told a reporter not to get “stuck on stupid”<sup>14</sup> in reference to a question about the government response to Hurricane Katrina when he thought the public should focus on preparedness for Hurricane Rita.

---

12 Web site: <http://www.positivedeviance.org/>; Wikipedia article: [http://en.wikipedia.org/wiki/Positive\\_Deviance](http://en.wikipedia.org/wiki/Positive_Deviance) ; two popular press commentaries: NY Times Magazine’s issue on “The Year in Ideas and Fast Company.”

13 [http://en.wikipedia.org/wiki/Russel\\_L.\\_Honor%C3%A9](http://en.wikipedia.org/wiki/Russel_L._Honor%C3%A9)

14 [http://www.youtube.com/watch?v=QVBY\\_SqzJl](http://www.youtube.com/watch?v=QVBY_SqzJl)

Less flamboyant, but equally impressive as a positive deviant, Admiral Thad Allen was initially assigned to “help bail [FEMA Director Michael Brown] out.” Four days later, he assumed full command of the search-and-rescue and recovery efforts, a post he held from 9 September 2005 to 27 January 2006.<sup>15</sup>

Another emerging case study to watch under the lens of positive deviance: Masdar City, UAE, which is being designed to rely entirely on renewable energy sources, be totally sustainable, and have a zero-carbon footprint. A success here would inspire innovation in new construction as well as renovations of existing cities.

Positive deviant thinking and attitudes are needed to identify innovative approaches that can revitalize our aging infrastructure, and create resilience.

**Multiple Use Attributes.** We now face homeland security problems of incalculable complexity that demand interdisciplinary, interorganizational, and multinational approaches to solution. One of these is resiliency of our infrastructure. In the first half-decade of homeland security, we have focused on critical infrastructure protection looking primarily at prevention of terrorist attacks and catastrophic natural disasters. While these are important issues for America, they must be put in context with the dual use of making our critical infrastructure resilient against the normal operational foibles, economic hiccups, and snafus. Multi-use facilities make economic sense. Furthermore, when infrastructure has multiple uses, at least one is often routine, so the system is constantly being exercised and does not need to be “stood up” in time of crisis. Dual use keeps operators on their toes, averting the inevitable complacency of waiting for a catastrophic event to occur.

Tappan Zee Bridge



**Retrofit vs. New Construction.** Retrofitting existing infrastructure can extend life, upgrade security, and otherwise enhance structures at a fraction of the cost of replacement. For example, retrofitting cable-stayed and suspension bridges with blast-protective materials has been performed on many key bridges and is the subject of ongoing S&T research, using the expertise of the Engineer Research and Development Center of the U.S. Army Corps of Engineers.<sup>16</sup>

The Tappan Zee Bridge spans the Hudson River for 4.9 km with 7 lanes of traffic and is a critical component of the

<sup>15</sup> [http://en.wikipedia.org/wiki/Thad\\_Allen](http://en.wikipedia.org/wiki/Thad_Allen).

<sup>16</sup> Mimi Hall, “Effort Underway To Protect Bridge Cables,” USA TODAY, September 14, 2007.

region's transportation infrastructure. "There's not much monumental about the Tappan Zee. Constructed on-the-cheap between Rockland and Westchester Counties and opened in 1955, it is a mess: overloaded, poorly engineered, in chronic need of extensive maintenance, and potentially dangerous. It is well-known for commuting surprises like an epidemic of "punch-throughs"—holes in the roadway where a chunk gives way and you can see the river below.<sup>17</sup> Planning for a replacement has proceeded for many years and currently includes commuter-train tracks and lanes for high-speed buses.<sup>18</sup>

While retrofit has its place and can address specific deficiencies, new construction provides an opportunity incorporate resiliency into the conceptual and as-built designs. Designers must balance factors such as construction costs, operational costs (energy efficiency), habitability, rentability, safety, adherence to codes, and aesthetics. Security and resilience must be factored into the design considerations from the very beginning.

Architecture. Evolving from current practices and current as-built structures to a future ideal requires careful planning and strong will to architect appropriate solutions. This requires risk analysis, threat analysis, capacity projections, use projections, and crystal-balling changes in technology.

Specific examples:

- resilient transportation logistics.
- robust power grid.
- secure, reliable communications and data that benefit business, finance, intelligence, education, and, indeed everyone.
- disaster infrastructure that can evolve from meeting basic survival needs to temporary structures and systems that are livable, pleasing, and humane. Too often, refugee camps and temporary housing are sterile with a low livability factor.
- preplaced assets; for example, "How much is enough with respect to redundant infrastructure?"
- preparedness decisions; for example, "How Clean is Clean?" as we remediate WMD contamination, mold, and other contaminants that people can be exposed to.
- innovative manufacturing technologies.
- uniform, consensus-based standards and codes.

---

17 Peter Applebome, "A Creaky Bridge, Too Far From the Days of a Power Broker's Rule," *New York Times*, February 25, 2007

18 William Neuman, "State to Replace, Not Rebuild, Tappan Zee Bridge," *New York Times*, September 26, 2008.

In the aftermath of Hurricane Katrina, FEMA provided 143,123 families with temporary housing units (travel trailers, park models, and manufactured homes) across the Gulf Coast. FEMA partnered with state, local, and voluntary organizations to identify housing gaps, track the resources of various agencies, and ensure a comprehensive approach to transitioning occupants to more suitable long-term housing options.<sup>19</sup> Plagued by formaldehyde contamination, the “Katrina Trailers” have been roundly maligned. About 4,600 remained occupied in early May 2009 as a May 30 closure date loomed.<sup>20</sup> FEMA’s attempts at moving residents to permanent housing have met resistance.<sup>21</sup> These housing issues are entangled with economic, health, age, and “strong racial and class differences.”<sup>22</sup>

### 2.4.5 Examples of Challenges and Opportunities

**Rethinking our Water Systems.** Water supply, treatment, sewage systems, and discharge of treated wastewater are an increasing issue in America as population growth and affluence increase demand. Across the world, more than a billion people lack access to clean water and sanitary defecation.<sup>23</sup> An innovation posed by an official from Nevada would be to find a way to “convert” flood water to useful water in parched regions.

Are there radical new approaches to how to store/move water?<sup>24</sup>

**A Resilient Electric System.** America uses a lot of electricity.<sup>25</sup> Smart grid is a loose term for modernization of electricity from generation through transmission and distribution to the user. A smart grid uses advanced digital technology to save energy, reduce cost, and increase reliability. In addition, features of Smart Grid can reduce carbon footprint and

The United States at Night



19 *Myths & Facts about FEMA Housing Following Katrina*, Release Date May 26, 2008, Release Number FNF-08-046.

20 Richard Fausset, Post-Katrina trailer residents fearful as eviction day looms, *Los Angeles Times*, May 6, 2009

21 Shaila Dewan, Leaving the Trailers: Ready or Not, Katrina Victims Lose Temporary Housing, *New York Times*, May 8, 2009. The deadline was pushed back in late May as hundreds of people remained in their trailers.

22 James R. Elliott and Jeremy Pais, Race, class, and Hurricane Katrina: Social differences in human responses to disaster, *Social Science Research* 35, (2), 295–321, June 2006. doi:10.1016/j.ssresearch.2006.02.003.

23 *The Big Necessity: the Unmentionable World of Human Waste + Why it Matters*, Rose George Metropolitan Books, 2008

24 Patricia Mulroy, General Manager, Southern Nevada Water Authority at a rollout event for Memo to the President: Invest in Infrastructure for Long-Term Prosperity, Brookings Institution, Washington, DC, 12 January 2009.

25 Satellite map image: Credit and Copyright: NOAA/ NGDC DMSP Digital Archive. <http://apod.nasa.gov/apod/ap970830.html>

promote energy independence. From a homeland security perspective, it has the potential to improve the resilience of the grid.

Then President-elect Barack Obama proposed legislation that included doubling alternative energy production in the next three years and building a new electricity “smart grid”<sup>26</sup> and subsequently appointed a national coordinator for the effort.

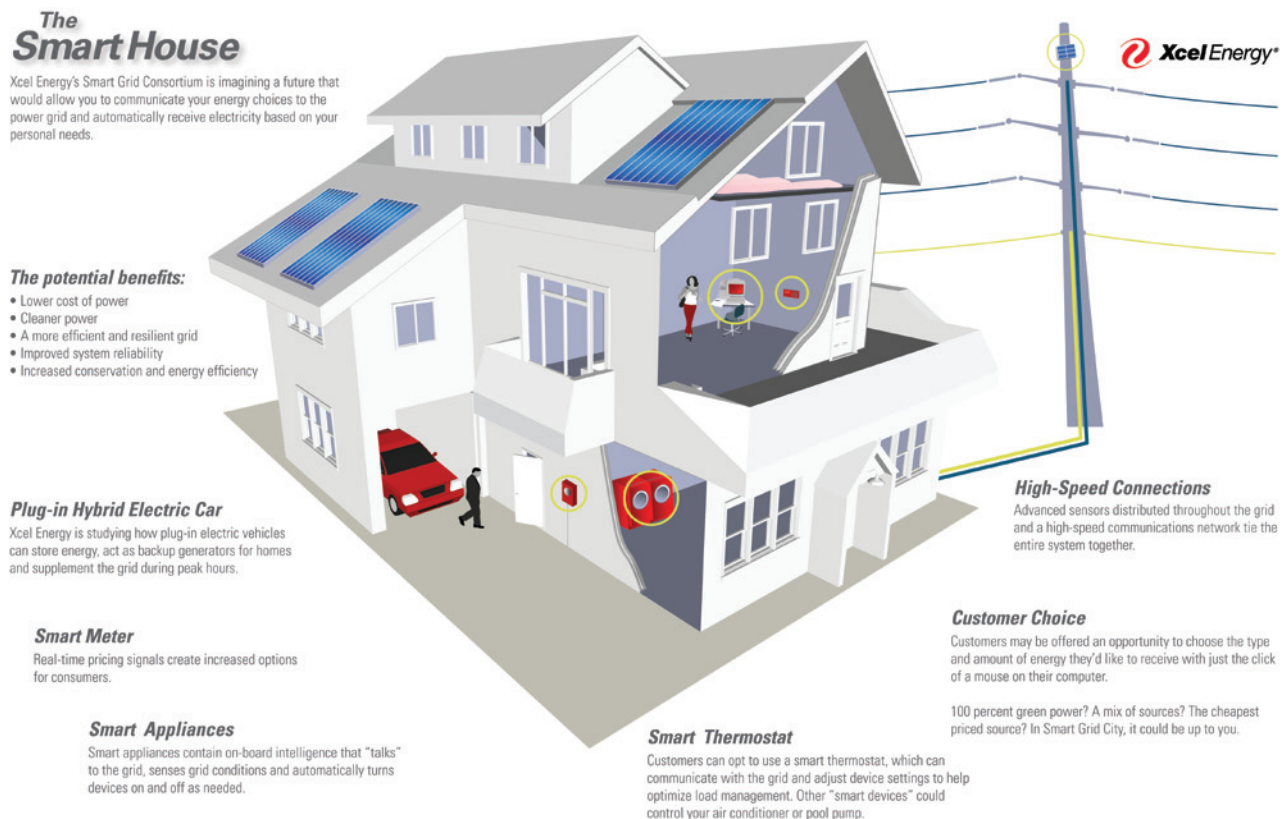

Figure 2-16: Xcel Energy's SmartGrid City

Xcel Energy, a Minneapolis-based power utility, and several partners are demonstrating SmartGridCity (Figure 2-16), the country's first city-scale smart grid, in Boulder, Colorado. Xcel's \$100 million program integrates technologies that give both an energy provider and its customers more control over power consumption. Sensors in transformers, smart meters, and fiber-optic communications provide real-time data that allows power stations to adjust the electrical supply, detect failing equipment, and predict overloads. Consumers, through a Web-enabled control panel in their homes, can adjust their energy consumption for economy—for

26 <http://www.nytimes.com/2009/01/08/us/politics/08text-obama.html>. On April 13th, 2009, George W. Arnold was named the first National Coordinator for Smart Grid Interoperability

example, by time-shifting appliance use automatically to reduce power use during peak hours. SmartGridCity's benefits might include a shift to more clean-power sources; energy conservation; fewer outages; and cost efficiency.<sup>27</sup>

Particularly at the consumer level, behavioral change requires nudges<sup>28</sup> through marketing campaigns for compact fluorescent light bulbs (CFLs), "green" appeals, and feedback devices. Ambient Energy Orb<sup>29</sup> is a "groovy little ball that changes color in sync with incoming data"—in this case, an electric meter rate signal. The Orb reminds customers of their instantaneous electric usage and alerts them when demand is high or low. Customers have reduced peak-period energy use by 40 percent.<sup>30</sup>

**Think out of the box.** For transportation, we might visualize the use of electric propulsion for both passengers and freight, while simultaneously charging the battery of a discrete vehicle. The vehicle could then enter or exit from local streets where self-contained propulsion would be needed. The concept drawing shown here illustrates buses only, but an adaptable mix of buses, cars, and freight vehicles would provide additional capacity and flexibility. The concept has been tested in Denmark, Los Angeles, and Seattle.<sup>31</sup> Cartoons are easy to draw, prototypes only moderately challenging, and enthusiasm from futurologists lavish.<sup>32</sup> The immense technical challenges to full-scale implementation include effective on/off ramps, guideway design and construction, intelligent switching of cars on/off, and effective integration of the systems. The societal challenges are every bit as daunting: securing rights of way, paying for construction and user costs, and supplying the additional electricity. Converting ideas like this to reality is an imposing challenge, but no more so than challenges that Americans have met many times throughout their history.

**Standards and Codes.** At many levels, standards, codes, and practices will affect our ability to deliver a resilient infrastructure. At the device and component level, there are myriad electrical, physical, communications, and computer standards that ensure proper function, encourage interoperability, and facilitate installation, operation, and maintenance. In the United States, more than 40,000 jurisdictions enforce building

---

27 Smart Grid Strategy and Vision, Xcel Energy

28 Richard H. Thaler and Cass R. Sunstein, *Nudge: Improving Decisions About Health, Wealth, and Happiness*, Yale University Press, 2008.

29 <http://www.ambientdevices.com/products/energyorb.html>

30 Clive Thompson, Clive Thompson Thinks: Desktop Orb Could Reform Energy Hogs, *Wired Magazine* 15.08, 24 July 2007.

31 RUF Dual Mode Transportation System.

32 25 Ways to Jump-Start the Auto Business, *Fast Company*, Issue 134, April 2009.

codes. Even within these jurisdictions, there are myriad agencies that need to permit construction. I have seen 18 permits posted in front of a home renovation in Greenwich Village, New York City.

Especially since 9/11, construction processes and building codes have evolved for both new structures and renovations to provide a safer-built environment. These objectives need to blend with other forces to not only protect the public but also ensure that America remains economically competitive on the world stage.<sup>33</sup> Clearly, standards and codes can push the national agenda and blend security with green construction, energy efficiency, application of new materials, and adoption of better processes. There is a need to streamline the processes beyond just “fixing the codes,” to an extent that leads to integration of the entire construction industry as discussed immediately below.

**Integrated Capital Projects.** Current issues such as security, environment, safety, economy, globalization, and changing uses combine to provide opportunities and challenges to the capital projects industry. The companies and professions that plan, design, procure, construct, and ultimately operate critical infrastructure can apply technologies, business practices, and governance to vastly improve the processes.

Integrated business practices will improve business flow during the complex design, permitting, procurement, and construction cycle for a large building, factory, or other structure. One effort to integrate, FIATECH, is a partnership to progress along a roadmap toward highly automated processes that seamlessly integrate people, organizations, and processes to reduce cost and time of these major projects.

This roadmap depicts a completely integrated structure composed of nine critical elements and can be thought of as a virtual enterprise for the near-term future:

- Scenario-based Project Planning
- Automated Design
- Integrated, Automated Procurement & Supply Network
- Intelligent & Automated Construction Job Site
- Intelligent Self-maintaining and Repairing Operational Facility

---

<sup>33</sup> Robert C. Wible, *Architectural Security Cods and Guidelines: Best Practices for Today's Construction Challenges*, McGraw-Hill, 2007, 340 pp.

- Real-time Project and Facility Management, Coordination and Control
- New Materials, Methods, Products & Equipment
- Lifecycle Data Management & Information Integration.
- Technology- & Knowledge-enabled Workforce

The potential benefits of integration and automation technology include:

- up to an 8 percent reduction in costs for facility creation and renovation
- up to a 14 percent reduction in project schedules
- repair cost savings ranging from 5 to 15 percent
- significant collateral benefits to homeland security by providing an industry focal point for improving capital facility resilience to external threats.

**Interdependencies.** America’s critical infrastructures and key resources (CI/KR) are the basic building blocks of our society and are critical to our economy, security, and way of life.

The component structures, systems, facilities, and institutions are sophisticated, complex, highly interdependent, and too-often fragile. Increasingly, infrastructure is interconnected via communications, data, transportation, finance, and other linkages that subject one component to stress or failure resulting from problems originating in another sector, often geographically and societally distant. Even simple retail transactions are stymied by power failures when the cash registers do not work and credit card charges cannot be put through. Threats come from natural hazards, terrorism, and innocent errors. A resilient infrastructure requires robust linkages at the key interconnects. As Americans, we can build and maintain these linkages only after we fully understand the threats and vulnerabilities. Modeling the performance under various disaster scenarios has matured in recent years,<sup>34</sup> but there are significant opportunities to improve the modeling, especially at the granularity needed to address business decisions by individual infrastructure owners or by regions.

**Exit 14.** In New Jersey, “What Exit?” is a shorthand query for, “Where do you live?” The NJ Turnpike (I-95 in its northern half) cuts diagonally

---

34 National Infrastructure Simulation and Analysis Center (NISAC), Department of Homeland Security (DHS), Sandia National Laboratories (SNL), and Los Alamos National Laboratory (LANL).



across the state, linking New York City (Exit 18) with Philadelphia and Wilmington (Exit 1). The turnpike serves as a major transportation corridor. Exit 14 is in Newark and connects the turnpike with Interstate 78 and other highways. Immediately surrounding Exit 14 are dozens of critical infrastructure elements including the Newark Airport (EWR), the Port of Newark/Elizabeth, freight rail, passenger rail, pipelines, and hundreds of businesses (Figure 2-17).



Figure 2-17:  
Exit 14, Newark, NJ.

- 1 A close shot showing NJ Turnpike going roughly N-S and the interchange with I-78 in the upper-right corner. Other interchanges are visible along the top. Newark Airport runways are in the lower-left. A slip of the Port of Newark/Elizabeth is in lower-right. Air freight is along the center-right edge. Airport parking is a bit above the center. (Google Maps)
- 2 A broader shot of the area, showing the navigable waterways, bridges, residential zones, and factories. (Google Maps)
- 3 From the foreground in the lower right to the distance: NJ Turnpike (6 lanes each direction and feeder and exit ramps), freight rail, big-box retail, Port Newark/
- 4 Port Newark Channel where roll-on/roll-off ships deliver the hundreds of vehicles seen in the foreground. Also visible are a pile of salt or some other commodity (right-center), containers, warehouses, the I-78 bridge, and a rail bridge (top-left) (M.D. Erickson)
- 5 Container Ship being unloaded. (M.D. Erickson]

DHS and the NJ Office of Homeland Security and Preparedness are conducting a study of the “Port Interdependency, Resiliency, and Resumption of Trade Plan: Port of NY and NJ,” which will examine the interdependencies of this complex, tightly interconnected area and develop recommendations for changes that will increase resiliency. The study team is working closely with the component infrastructure owners, such as the Port Authority of New York and New Jersey.

### 2.4.6 Models for Our Future

Many local, regional, and national efforts are underway, pushing toward a resilient infrastructure. Some are more direct than others. President Obama’s statement in the introduction to this paper quite directly calls for a different, more resilient future. Below, New York’s plan for 2030, a national coalition, and a National Academies of Science report provide three examples of others’ thinking.

#### PlanNYC: A Greener, Greater New York

*PlanNYC: A Greener, Greater New York* is a design for the sustainability and resiliency of New York City, with a vision for the city over the next 25 years. The plan sets priorities for the city’s infrastructure, based on three overarching assumptions:

- NYC will be getting bigger (much bigger).
- NYC’s infrastructure will be getting Older. (And it’s pretty old to begin with).
- NYC’s environment will be at risk (and that’s not a risk worth taking).

## The Plan

In December 2006, Mayor Michael R. Bloomberg challenged New Yorkers to generate ideas for achieving 10 key goals for the city’s sustainable future. New Yorkers in all five boroughs responded. The result is the most sweeping plan to enhance New York’s urban environment in the city’s modern history. Focusing on the five key dimensions of the city’s environment— land, air, water, energy, and transportation— the city developed a plan that can become a model for cities in the 21st century. The combined impact of this plan will not only help ensure a higher quality of life for generations of New Yorkers to come; it will also contribute to a 30% reduction in global warming emissions.

Selected Specifics:

- Congestion Pricing<sup>35</sup>
- Add 1800 miles of bike paths.
- Upgrade transportation Infrastructure (additional subway capacity, commuter rail, express bus...)
- Revise building codes for such endpoints as green parking lots and blue roofs. (Retain rain water until sewers can handle the flow.)
- Improve water supply and distribution.
- Plant 1 million trees.
- Reduce electric bill from \$5 billion ( $5 \times 10^9$ ) to \$3 billion ( $3 \times 10^9$ ) by 2015.
- Clean up water, air, and the environment.

**Infrastructure Impacts.** These climate changes will have consequences for New York City's critical infrastructure.

Temperature-related impacts may include:

- increased summertime strain on materials
- increased peak electricity loads in summer and reduced heating requirements in winter.

Precipitation-related impacts may include:

- increased street, basement & sewer flooding
- reduction of water quality.

Sea level rise-related impacts may include:

- inundation of low-lying areas & wetlands
- increased structural damage & impaired operations.

**National Implications.** PlanNYC focuses on New York but can have broader implications:

- Interdependencies are universal. We cannot afford to address New York or the nation in a piecemeal manner.
- This NYC-centric effort can serve as a template and for national visionary planning on an integrated and massive scale.

---

<sup>35</sup> This was proposed to the NY State Legislature and rejected in 2008.

- There are opportunities to influence decisions that improve homeland security while also meeting PlanNYC goals.
- There are lessons about public communications, scientific involvement, grass-roots volunteerism, and political negotiations that have implications for other cities, states, and indeed the federal stage.
- We need to focus beyond the primary impacts of population, infrastructure, and environment to questions about secondary and tertiary impacts, such as whether nor'easter storm frequency or intensity will increase.
- As PlanNYC and other integrated planning efforts mature, we need to examine the underlying assumptions (such as how many people come to work) and recraft goals to a truly 21st century vision and not merely a tweaking of our prior investments.

### 2.4.7 A National Coalition

“Building America’s Future” will serve as a repository of best practices on infrastructure funding issues and become a think tank focusing on emerging infrastructure issues. The organization will advocate a new era of strategic planning, economic analysis, accountability, and rigorous performance standards for U.S. infrastructure investment. It will also advocate infrastructure policy that is forward-thinking and comprehensive in scope, yet grounded in the need for environmental sustainability, lower carbon emissions, and reduced U.S. dependence on foreign oil.

### 2.4.8 The 2009 National Academy of Sciences Report

In early 2009, America’s National Academy of Sciences issued a report, *Sustainable Critical Infrastructure Systems: A Framework for Meeting 21st Century Imperatives*. The findings in the report are consistent with the arguments here and are compellingly presented. A key section of the “Findings” section is quoted below:

At a time when many have called for infrastructure renewal in some form and have suggested billions or trillions in investment, there is an important opportunity to fundamentally reexamine the purposes and value of critical infrastructure systems and of the decision-making processes used for investing in them. While daunting, this reexamination can yield a new paradigm from which to develop practical, cost-effective solutions to complex challenges and help meet the needs of future generations. Some of the ingredients needed to create a new paradigm are available today. Research has yielded technologies for monitoring infrastructure condition

and performance, new materials for constructing and repairing infrastructure components, and new knowledge about the inter-related nature of water and wastewater, power, transportation, and telecommunications systems. Self-diagnosing, self-healing, and self-repairing systems can be designed to provide for greater resiliency, fewer long-term service disruptions, and lower life-cycle costs.<sup>36</sup>

An array of financing mechanisms, strategies, plans, and approaches to infrastructure renewal that offer new ways to provide for essential services has been developed through local, state, and regional initiatives.

To date, however, infrastructure-related technological advances, plans, approaches, and community-based initiatives have been ad hoc in nature, often focusing on one issue, one type of system, or one set of solutions.

Lacking a national vision or strategy for critical infrastructure renewal and concentrating on single projects, technologies, financing mechanisms, or narrowly defined objectives, ad hoc efforts run the risk of underutilizing or wasting scarce resources and increasing the probability of serious, unintended consequences. **A framework is needed to structure these efforts so that ongoing activities, knowledge, and technologies can be aligned and leveraged to help meet multiple national objectives.** The essential components of the needed framework are as follows:

- **A broad and compelling vision** that will inspire individuals and organizations to pull together to help meet 21st century imperatives by renewing the nation's critical infrastructure systems. Such a vision would focus on a future of economic competitiveness, energy independence, environmental sustainability, and quality of life, not a legacy of concrete, steel, and cables.
- **A focus on providing the essential services involving water and wastewater, power, mobility, and connectivity**—in contrast to upgrading individual physical facilities—to foster innovative thinking and solutions.
- **Recognition of the interdependencies among critical infrastructure systems** to enable the achievement of multiple objectives and to avoid narrowly focused solutions that may well have serious, unintended consequences.



A framework is needed to structure these efforts so that ongoing activities, knowledge, and technologies can be aligned and leveraged to help meet multiple national objectives.

<sup>36</sup> Massoud Amin and John Stringer, *The electric power grid: Today and tomorrow*. MRS Bulletin, 33, pp 399-409, April 2008.

- **Collaborative, systems-based approaches** to leverage available resources and provide for cost-effective solutions across institutional and jurisdictional boundaries.
- **Performance measures** to provide for greater transparency in decision making by quantifying the links among infrastructure investments, the availability of essential services, and other national imperatives.

An important first step in creating a new paradigm is to bring together those who have an essential stake in meeting 21st century imperatives and who are already involved in sustainable infrastructure efforts. They include infrastructure owners, designers, engineers, financiers, regulators, and policy makers, as well as ecologists, community activists, scientists, and researchers. Working

within the framework, experts in such areas could begin to identify a full range of new approaches, technologies, and materials for providing services involving mobility, connectivity, water, wastewater, and power to meet multiple objectives. They could also identify new approaches to the decision making, finance, and operations processes related to critical infrastructure systems. The results of such a gathering could serve to initiate a longer-term, collaborative effort to develop a vision that would provide guidance for developing concepts and objectives for the nation's critical infrastructure systems and then to identify the policies, practices, and resources required to implement them. **The results could be critical infrastructure systems that are physically resilient, cost-effective, socially equitable, and environmentally sustainable for the next 50 years.**



The results could be critical infrastructure systems that are physically resilient, cost-effective, socially equitable, and environmentally sustainable for the next 50 years.

objectives for the nation's critical infrastructure systems and then to identify the policies, practices, and resources required to implement them. **The results could be critical infrastructure systems that are physically resilient, cost-effective, socially equitable, and environmentally sustainable for the next 50 years.**

### 2.4.9 Concepts

As New York and by extension, the nation, addresses PlanNYC, we need to consider many alternatives and apply science and technology now to assess the efficacy of these and many other options:

- **Reduce flooding impact** by moving boilers and electrical out of basements.
- **“Waterproof”** hospitals, nursing homes, and other critical infrastructure with a sacrificial first floor or by sheathing the floodable elevations.
- **Construct flood gates** across Verrazano Narrows and two other ocean-accesses to retard storm surge.

- **Raise the street level** like Chicago<sup>37</sup> and Galveston<sup>38</sup> did in the 1850s–1860s and 1900s, respectively.
- Plan big, but **build incrementally**. For example, a protective storm-surge barrier that incorporates access, commerce, ecological continuity, ocean hazards protection, and inland value could be constructed in phases that are timed and adjusted as the threat projections unfold. This would also allow investment to be spread over many decades.<sup>39</sup>
- Consider **high-speed, automated freight rail** to deliver goods and remove much of the freight from the highways and freight air. This national system would have spurs reaching into metro areas such as New York. Currently, New York City is not served by freight rail; all incoming goods and outgoing exports and waster must be transported by other means.<sup>40</sup> Forecasts indicate that the demand for goods in the metropolitan region will grow roughly 70 percent by 2025. Just the cross-harbor tunnel to connect Brooklyn and Long Island with the mainland is projected to cost from \$4.8 billion ( $4.8 \times 10^9$ ) for the single tunnel system to \$7.4 billion ( $7.4 \times 10^9$ ) for the double tunnel system.
- **Rail may not be the only solution**. Short-seas shipping may provide alternatives. Maglev, pneumatics, or even conveyor belts may win out once an objective examination of the various options is conducted.
- Use a **certification system** for resilient structures and systems along the lines of, or in collaboration with, the Leadership in Energy and Environmental Design (LEED) certification system that “measures how well a building or community performs across all the metrics that matter most: energy savings, water efficiency, CO<sub>2</sub> emissions reduction, improved indoor environmental quality, and stewardship of resources and sensitivity to their impacts.”<sup>41</sup> Resilient Certification would re-

---

37 [http://en.wikipedia.org/wiki/Raising\\_of\\_Chicago](http://en.wikipedia.org/wiki/Raising_of_Chicago)

38 1907 Elevation Saved Galveston Church from Flooding, FEMA, December 4, 2008; Michael A. Smith, “The 1900 Storm: Tragedy and Triumph,” *The Daily News*.

39 *Personal Communication*, John Voeller, OSTP, April 2009

40 New York City Economic Development Corporation (NYCEDC), in coordination with the Federal Highway Administration (FHA) and the Federal Railroad Administration (FRA), has completed the preparation of a Draft Environmental Impact Statement (DEIS) for the Cross Harbor Freight Movement Project. The evaluation process, which began in 2002, involved the rigorous examination of the alternatives based on the engineering requirements; capital, and operating costs; environmental impacts and benefits; transportation issues; and opportunities and economic benefits.

41 U.S. Green Building Council (USGBC) Web site.

ward those who build or renovate infrastructure to maximize the key metrics of resilience.

- In the near term, incorporate resiliency concepts into implementation of “**PS Prep**” (Private Sector Preparedness Accreditation & Certification Program).<sup>42</sup> This “9/11 legislation” stipulates that the program should, among other things, provide a method to independently certify the emergency preparedness of private sector organizations, including disaster/emergency management and business continuity programs.
- Take advantage of **wind power**, using urban wind screws with a vertical profile fitting within urban canyons. These wind screws would use the turbulent winds and updraft from the urban heat island. The electric generation might be combined with pumped storage of water to the top of high rises, for subsequent use and/or power generation. Or, a turbine might double as an escape route—an incredibly outsized slide like the kind we used on playgrounds. Or, a turbine might double as an escape route—an incredibly outsized slide like the kind we used on playgrounds.
- **Green roofs** with plants to absorb water are well-established; **blue roofs** that simply hold the water until the sewer systems can handle it or for grey-water uses would also substantially reduce impacts on water and sewage systems.
- **Antimicrobial coatings** can reduce infections in hospitals, locker rooms, and other confined areas. Bioshield 75, for example, can kill viruses, mold, bacteria, and other microbes.<sup>43</sup>
- **Permeable pavement** allows surface water to seep back into the earth after being filtered of many pollutants, reducing the volume of storm water runoff that can cause flooding. If the runoff enters a sanitary sewer, it taxes the capacities of water treatment facilities; if it is discharged into a waterway, it carries pollutants.

**Electrochromic glass is coming on the market.** The glass is a multilayer composite. SageGlass® is an example:

42 The Implementing Recommendations of the 9/11 Commission Act of 2007 (Public Law 110-53—Title IX, Section 524) was signed into law on August 3, 2007. Section 524 calls for the creation of a voluntary business preparedness accreditation and certification program.

43 The coating is spray-applied and protects for more than 30 days. The molecule is an organosilane quaternary amine that copolymerizes after application to a surface; the free end conforms to a spike. The positively charged amine moiety attracts negatively charged microbes that then become impaled and ruptured. It is also used as a coating in air filters for vehicle and aircraft cabins



- When voltage [less than 5V DC] is applied to these layers in their “clear” state, they darken as lithium ions and associated electrons transfer from the counter electrode to the electrochromic electrode layer. Reversing the voltage polarity causes the ions and associated electrons to return to their original layer, the counter electrode, and the glass un-tints. When the electrochromic coating darkens, the sun’s light and heat are absorbed and subsequently reradiated from the glass surface—much the way low-emissivity glass also keeps out unwanted heat.<sup>44</sup>

The product has both privacy and energy-efficiency attributes. In the concept of dual use, one could consider the following additional adaptations:

- **Privacy**—There are certain high-value rooms or buildings where it may be important to automatically make the glass go opaque. I assume it would be a trivial application for you to wire your windows into a control system that makes them go opaque under certain preset conditions.
- **Blast resistance**—A major hazard during an explosion is flying debris, especially glass fragments. There are several laminated glass options out there with varying levels of blast resistance.

#### 2.4.10 S&T Opportunities and Obligations

The opportunities for America to improve its resiliency depend on, among other things, implementing new technological solutions. The scientific and engineering communities can infuse scientific approaches as well as new technologies into other ongoing programs. DHS S&T can contribute through modeling interdependencies, logistics modeling, modeling the intermodal operations, and demonstrating dual use. Basic science in enabling technologies will pay off in sensors, protective measures, advanced materials, nanoscale coatings, and multiple other unforeseen areas.

- Baseline “facts” about the dismal shape of America’s infrastructure need an **independent validation** and an analysis of alternatives that goes beyond the “repair or let it fall apart” dichotomy.
- **Provide better information.** Instrumented structures (Smart Buildings) can monitor health, identify trends, and predict failure. Data will become ever cheaper as sensors and communications become more efficient. Mountains of data are of no use until we convert the data to useful information that

---

44 <http://www.sage-ec.com/>.

enables decisions, reduces uncertainty, and provides warnings or assurances.

- **Materials science** will continue to produce new structural, coating, lighting, photovoltaic, and sensor materials.
- **Engineers and inventors** will apply novel materials and novel construction concepts to provide better, faster, cheaper structures.
- We are just beginning to understand **interdependencies**. With better understanding and models, we can prioritize activities, schedule logistics, and call upon precious resources from all sectors during both crisis and ongoing operations.



A key interdependency is intermodal transportation and shipping.

We also need to know better how to rebuild, rejuvenate, and repurpose as-built infrastructure to accommodate future capacity and changing modalities. A key **interdependency is intermodal transportation and shipping**.

- **Risk Assessment** is pervasive in the science, homeland security, finance, insurance, commercial, and health care disciplines and many others. Different disciplines assess risk differently, partly because of differencing priorities, but also because of poor assumptions and models. The science community can work to both improve the science of risk assessment and harmonize the different communities.
- **Risk education** is needed at all levels so that society can address decisions that involve deferred risks or payoffs, including global climate mitigation, extra capacity for anticipated future needs, and deferring payments to the next generation. We also need to make risk-informed decisions with complex risk factors such as fire safety, livability, hurricane-proofing, financial return, terrorism, environmental impact, human exposure, structural life, initial cost, and ongoing operational expenses.
- **Adaptive systems** can learn to react rapidly to changing conditions and can operate under conditions of high uncertainty. For example, transportation networks can be trained to adapt to congestion, accidents, or outages. Adaptive electric network management can level power loads and prevent cascading outages.
- **Assess assumptions.** Many decisions about next-generation infrastructure assume that people will continue to come to work as before, continue to live where they have, buy similar goods, consume information the same way, and use transportation for travel and shipping about as before. Some assumptions are valid, some not. Science-based scenario modeling can test the validity of assumptions.

- Advance **future projections** and predictions to understand and thereby reduce uncertainty. Ongoing societal changes such as redistribution of the workplace can radically impact future projections. We need to move beyond current practices that are, in many cases, mere guesses. Can we develop robust models that can reliably project the impact of future issues such as changes in travel as we mature video teleconferencing, shift populations, and change work habits? Although some technologies will apply in the future, the needs, constraints, and rules will be quite different. If well-understood, we can exploit these future demands to pursue innovative solutions in directions we have never before considered. Albert Einstein summed it up nicely: **“We cannot solve our problems with the same thinking we used when we created them.”**
- **Standards** in so many areas are key to interoperability, economic efficiency, stable business models, and technological advances. We need to improve and unify building codes and permitting processes, among other standards. Standards and enforcement are also keys to protecting against unintended consequences of better, faster, cheaper materials and construction methods that may fail,<sup>45</sup> emit toxic gases,<sup>46</sup> or be excessively combustible, for example.
- **Governance models** are too-often rooted in centuries-old laws and customs and do not address the needs of the 21st century. In particular, we need to think, plan, and govern across state and other boundaries because disasters do not respect political boundaries. We need to replace competitive, zero-sum-game with partnership behavior. We need to modernize financing, cash flow, and project management processes. Understanding and exploiting the value chain can ensure that all interests are balanced: users of commercial facilities typically have no say in the design, construction, and security of commercial facilities, except through standards, codes, and government regulation. Science can provide better tools to assess and predict regional resilience issues.



“We cannot solve our problems with the same thinking we used when we created them.”

— Albert Einstein

45 A notable example is the ceiling collapse at Boston’s Big Dig, caused by a failure of an epoxy used to hold the bolts into concrete.

46 The infamous formaldehyde in the FEMA travel trailers used as temporary housing after Hurricanes Katarina and Rita is just one example of “sick buildings” caused by inferior or improperly applied materials.

- **Financing models** can be improved to change budgeting processes; allow governmental savings accounts for anticipated and unanticipated maintenance and capital projects; better understand the impact of user fees, tolls, and gas taxes; and examine the impact of current and future pricing policies. For example: General thinking is that water is now grossly underpriced to the user. Is this a leverage point for shifting demand and usage? Also, would governmental savings accounts induce better planning and future-thinking? How can we model these changes without resorting to trial-and-error legislation?
- **Manufacturing and business models.** 21st century infrastructure will require 21st century manufacturing, a more nimble workforce, consensus-based standards, performance-based codes (not prescriptive codes), and tempered liabilities. The FIATECH model discussed above provides a roadmap for near-term improvements; we can build on this type of thinking for future generations' integrated capital projects and systems architecture. Business scientists can help move our construction, materials, engineering, architecture, and logistics industries toward a lean-and-mean solution.

### 2.4.11 Conclusions

This paper presents a vision of America's future infrastructure that will increase the nation's resiliency, reap the benefits of improved societal efficiencies, and strengthen America on the world stage. America must develop and implement technologies, processes, standards, codes, and laws that enable the vision. A blueprint is needed that will require a national discourse on priorities and technological assessments that provide solid, compelling evidence for a positive cost/benefit ratio. The issues of governance, integrated planning, finance, and societal prioritization require a discourse among all American institutions and individuals. The scientific [Hilary] Cottam is one of a new wave of design evangelists who are trying to change the world for the better. They believe that many of the institutions and systems set up in the 20th century are failing and that design can help us to build new ones better suited to the demands of this century. Some of these innovators are helping poor people to help themselves by fostering design in developing economies. Others see design as a tool to stave off ecological catastrophe. Then there are the box-breaking thinkers like Cottam, who disregard design's traditional bounds and apply it to social and political problems. Her mission, she says, is "to crack the intractable social issues of our time."<sup>47</sup>

---

<sup>47</sup> Alice Rawsthorn, Can Design Solve Social Problems?, Fast Company, Issue 130, November 2008.

Traditionally, science and technology have provided a toolbox of new technologies, new materials, new monitoring, better controls, and optimization models. Scientists and inventors will continue to provide new toolbox-advances that will shape the discussion on how we achieve a resilient infrastructure. More important, science and technology can contribute to shaping our blueprint by instilling scientific rigor into the process and engaging with the other sectors that will shape our future. Science's role in understanding interdependencies at multiple scales, setting standards, examining underlying assumptions, informing decisions with data, envisioning possible future technologies, developing architectures, improving risk assessment, analyzing alternatives, and running scenarios is critical to optimize and rationalize the vision. Science and technology can also contribute to providing 21st century governance, financing, manufacturing, and business models.

Intelligent revitalization and expansion of America's infrastructure requires innovation on many physical and temporal scales. Scientists and engineers have a voice and a role in shaping this vision. The science and technology community needs to participate in the discourse and provide guidance on the technical, economic, and social possibilities for our future.

Intelligent revitalization and expansion of America's infrastructure requires innovation on many physical and temporal scales.

### 2.4.12 Acknowledgments

Many people are thinking about this topic, including President Barak Obama. Closer to home, those who have informed my thinking and contributed to development of this concept include Rick Adler, Gail Cleere, Jay M. Cohen, Mohammed Ettouney, Mary Ellen Hynes, Mila Kennett-Reston, Bradford Mason, Priscilla Nelson, Glenn Paulson, Mary Raymond, Michael Smith, Paul Stregevsky, John Voeller, Frank Westfall, and Robert Wible.

Note: This article discusses technologies, concepts, and policies of interest to the homeland security community. The views expressed here are those of the author. Mention of a technology, product, or concept should not be construed as an endorsement by the Federal government.



# Bridges: A Critical Issue

## In this chapter:

The papers in this chapter all discuss various aspects of bridges. Bridges are engineering structures of critical importance because they are a potential weak link in a pedestrian, highway, or rail system that is essential for the movement of goods and people, and their failure can result in injury and deaths. Millions of people travel over bridges every day: the Oakland-San Francisco Bay Bridge is traversed by 250,000 vehicles a day and its closure for a month as a result of damage incurred in the Loma Prieta earthquake of 1989 caused major economic losses through lost time. To ensure this does not happen again, it is currently being replaced by a new span that costs over \$5 billion and will open in 2013.



The papers in this chapter all discuss various aspects of bridges. Bridges are engineering structures of critical importance because they are a potential weak link in a pedestrian, highway, or rail system that is essential for the movement of goods and people, and their failure can result in injury and deaths. Millions of people travel over or bridges every day: the Oakland-San Francisco Bay Bridge is traversed by 250,000 vehicles a day, and its closure for a month as a result of damage



The papers in this chapter all discuss various aspects of bridges. Bridges are engineering structures of

critical importance because they are a potential weak link in a pedestrian, highway, or rail system that is essential for the movement of goods and people, and their failure can result in injury and deaths.

incurred in the Loma Prieta earthquake of 1989 caused major economic losses through lost time. To ensure this does not happen again, it is currently being replaced by a new span that costs over \$5 billion and will open in 2013.

“With more than 3 trillion traveled bridge vehicle miles annually, 223 billion miles being truck traffic, traffic loading is one of the major factors in the deterioration of America’s bridges... These 590,000 bridges are essential for the transportation of the Nation’s commerce as well as carrying thousands of commuters to and from work every day (AASHTO, 2008). Bridges are essential for the economy of this country but are easily overlooked since they are traveled safely day in and day out.” (Bell, Paper 3.4)

“No planned engineering experiment can match the social and professional impact of an unintended structural collapse. The shock value of the suddenly perceived ignorance and the usually considerable losses add up to a lesson easy to understand and remember by non-professionals. Despite the advances in abstract analysis and controlled testing, failures have the most conspicuous influence on bridge design, construction, and management.” (Yanev, Paper 3.2)

“The FHWA rates 13.1% of America’s highway bridges ‘structurally deficient’ and an additional 13.6% as ‘functionally obsolete.’ Most remain open to traffic. One of these was the I-35 Bridge over the Mississippi River. More than 1500 bridges failed between 1966 and 2005, 60% due to soil erosion around the bridge supports—a weakness seldom checked for in inspections. ASCE estimates that it will cost \$17 billion per year over 20 years to eliminate bridge deficiencies compared to the \$10.5 billion currently being spent.” (Meisinger, Paper 4.1)

The FHWA rates 13.1% of America’s highway bridges ‘structurally deficient’ and an additional 13.6% as ‘functionally obsolete.’ Most remain open to traffic.



Large-span suspension bridges are, perhaps, the supreme example of the bridge designer's art, and they also carry large volumes of highway or rail traffic. There have been spectacular failures, such as the Tacoma Narrows Bridge in Washington State.

“Suspension bridges represent a small portion of the total bridge population; however, they are essential to transportation, and at the forefront of engineering innovation. Consequently their failures are critically important not only quantitatively but also qualitatively. H. Petroski (1993) regards failures are inherent in the creative process of bridge design and construction. Citing earlier work by Sibly and Walker in England, he argues that each innovative bridge form is developed by trial and error until its limits are surpassed and spectacular failure occurs. Only then does theory catch up with the practice and fully explains the structural behavior.” (Yanev, Paper 3.2)

“Interacting and complex deterioration mechanisms make the task of determining the ‘actual’ strength, and its variation with time, of main cables of suspension bridges extremely difficult. Methodologies currently used in design practice do not account for the actual deteriorated conditions of the wires; the use of a ‘ductile’ model for the wires in the estimation of the residual cable strength has been proven to be valid only for new bridges and overestimates the ‘actual’ cable strength in existing bridges.” (Betti et al., Paper 3.3)



More than 1500 bridges failed between 1966 and 2005, 60% due to soil erosion around the bridge supports—a weakness seldom checked for in inspections.



## Papers

**Paper 3.1 Aging Infrastructure — Roles and Challenges***Sheila Rimal Duwadi***Paper 3.2 Suspension Bridge Cables: 200 Years of Empiricism, Analysis and Management***Dr. Bojidar Yanev***Paper 3.3 Aging Cables in Suspension Bridges***Raimondo Betti, Ah Lum Hong, Dyab Khazem, Mark Carlos, and Richard Gostaudas***Paper 3.4 Integrating Baseline Structural Modeling, Structural Health Monitoring and Intelligent Transportation Systems for Condition Assessment of In-Service Bridges***E.S. Bell and J.D. Sipple***Paper 3.5 Bridge Vulnerabilities and the Practical Application of Advanced Composite Materials for Hardening, Strengthening, and Extending Service Life***Amjad Aref, Ph.D. and Jerome S. O'Connor, P.E.***Paper 3.6 Managing Aging Bridges and Their Networks***R.B. Testa, H.C. Wu, M.J. Garvin, and B. Yanev***3.1 Aging Infrastructure — Roles and Challenges**

*Sheila Rimal Duwadi, P.E., Senior Research Structural Engineer,  
Federal Highway Administration, Turner Fairbank Highway Research  
Center*

**3.1.1 Introduction**

**E**fficient use of resources requires greater understanding and awareness of critical issues. The Federal Highway Administration (FHWA) continues to play a critical role in building, maintaining, and rebuilding; however, it does not own any highway infrastructure and it is not a regulatory agency. The FHWA works in partnership with other

infrastructure owners such as States and local authorities in carrying out the highway program.

Often times the general level of awareness of critical issues is missing when decisions are made for resource allocation leading to ill directed projects. Therefore, it is essential to have the necessary level of technical expertise to sufficiently deal with critical issues.

### 3.1.2 Roles & Responsibilities

The Federal Highway Administration's role is four-fold: it works with the State and local departments of transportation in carrying out the federal aid program; designs, constructs, inspects & maintains federally owned highway network; conducts research and development to address highway transportation issues; and provides education and technology transfer.

Traditionally, Research and Development in the transportation field has been conducted, in addition to the Federal Highway Administration, through programs sponsored by the Transportation Research Board, the State Departments of Transportations through state sponsored research, and the industry. This traditional role is now expanding to include the University Transportation Centers, the National Science Foundation, the National Institute of Science and Technology, and the Department of Homeland Security. The expanding number of entities involved in addressing transportation issues presents both opportunities and challenges, i.e., opportunities in being able to address more issues, and challenges in coordination and understanding of the types of research being conducted overall. As there are considerable needs, it is essential that research address issues that will lead to closing the needs gap.

### 3.1.3 The Highway System

Our highway infrastructure consists of millions of miles of roadways and thousands of bridges as shown in figure 3-1. The vast majority of these roads and highways are owned by state and local agencies, with the Federal government owning a small percentage such as in parklands, forest service lands, etc. The highway network is essential for the movement of people and goods and the economy depends on the system being open and accessible. The National Highway System which consists of the Interstate System and other primary routes carries 60% of traffic and 80% of all truck traffic.



This paper summarizes the presentation made by the author at the Department of Homeland Security's Aging Infrastructure Workshop in July 2009. It discusses Federal Highway Administration roles and challenges of aging infrastructure, and highlights some of the issues with aging bridges, hazard mitigation, and bridge security.

**INFRASTRUCTURE TYPE:** Highway bridges

The highways are critical both during normal times and during hazard events for evacuation, response and recovery. More damages and losses can be attributed to response and recovery or lack of than the hazard event itself, as a manageable event can quickly turn into a disaster if adequate response and recovery is unavailable. How quickly a community can bounce back from an event many times is dependent on how fast the infrastructure can be restored. Therefore, the importance of keeping the highways safe and passable is the key for ensuring a hazard event does not lead to a disaster. It is oftentimes perceived, however, that because of the vast network of roadways, in times of crisis, alternate routes will exist. In many areas of the country alternate routes can be long by several hundred miles. Also, it is often perceived that alternate form of transportation exists. In many areas of the country this is not the case, i.e. access to ferries, transit or other modes of travel is non existent. The importance highways plays in our lives cannot be overstated.

The average age of our bridges is around 44 years. Based on the National Bridge Inventory a database of all bridges on public roads greater than 20 ft long, of the 600,000 bridges, about 25% are either structurally deficient or functionally obsolete. “Structurally deficient” is a term used for a bridge with reduced load-carrying capacity and significant bridge elements with deteriorated conditions. “Functionally obsolete” is a term used for a bridge that has geometrics that do not meet current design standards. These terms are used to summarize bridge deficiencies and do not indicate that a bridge is unsafe. (Duwadi, et al.) The American Society of Civil Engineers 2009 Report Card for America’s Infrastructure in rating our infrastructure gives a grade of C for bridges and a D- for roads (ASCE).

### HIGHWAY INFRASTRUCTURE

#### Highways

- 47,000 miles—Interstate
- 114,000 miles—Other NHS Roads
- 4,000,000—Other Roads
- 600,000 Bridges
- 300 Tunnels

#### National Highway System (NHS)

- Carries 60% of All Traffic
- 80% of All Truck traffic

### 3.1.4 Aging versus Other Hazards

Aging infrastructure is a concern especially since deterioration is outpacing our investment in maintenance and/or renewal. Infrequently there are failures but most have involved other factors rather than age. Failures have occurred due to natural and or human induced events, design and/or construction errors, and environmental causes. Around 82% of our bridges cross waterways, and currently more bridge collapses occur due flooding and scour than any other causes combined.

Figure 3-1: Highway Statistics

Attention has been given to improving current designs to withstand natural hazards, and less so human induced events; however the greater future issue may become those associated with age. The solutions developed to address age issues can be drastically different from those to withstand natural and human induced events. Even with natural and human induced events designing for each situation is unique and often do not overlap. Why a structure fails is dependent on the structure type and the nature of the forces it sees. Fire, blast, earthquake, flooding and scour, terrorism, wind events, wave forces, impact loadings, fatigue and fracture and corrosion each represent a situation and/or event that may cause a bridge or bridges to fail, and there is not yet one solution that can be built in which makes a structure immune to these loadings.

### 3.1.5 The Impact of Aging

The Nation has approximately 250 thousand concrete bridges and 130 thousand prestressed concrete bridges. The main issues with concrete structures are deterioration leading to cracking, scaling, delamination, and spalling of concrete, and the corrosion of reinforcing steel. Several years ago a box beam bridge in Pennsylvania basically broke in half due to corrosion of the strands as shown in Figure 3-2.



Figure 3-2:  
Box Beam Bridge Failure in  
Pennsylvania

The Nation has approximately 27 thousand timber bridges on public roads. The issues of concern for these bridge types are decay and deterioration due to environmental causes, improper moisture management, detailing, and construction and maintenance.

There are 189 thousand steel bridges and many of the older structures may be nearing their fatigue life. The main issues of concern for steel bridges are corrosion of steel members (Figure 3-3), and fracture and fatigue of structural details. With newer bridges employing newer steels, better details and coating systems, these issues may not be as prominent; however there are still many older structures with fatigue prone details and/or insufficient coating systems that will still be in service for many years.

While not significant in numbers, long span suspension and cable supported bridges have their own unique concerns. The issues of concern include vulnerability of wires to corrosion and breakage, ineffective cable protection systems, overall corrosion, fatigue and excessive vibrations.

**Figure 3-3:**  
Corrosion of a steel member.

SOURCE: HERMAN



### 3.1.6 Security versus Aging

Unlike age and/or natural events, the challenges with security are that the threats are ever changing, and with the probability of an event being low, decision making to provide mitigation becomes all the more difficult. Security mitigation is often implemented in the face of overwhelming needs, which makes designing for security more challenging. With changing threats, there are limitations on what can be done in terms of structural retrofits, and designing for security. Altering a structure to withstand terrorist type loadings in terms of the extra weight the structure may have to carry and or the standoff distances that needs to be provided to make the security measures effective may not be feasible in many cases especially on older structures. There aren't too many structures where a lane can be closed to keep traffic away from a critical member. In addition a security measure that alters a structure may end

up being incompatible with mitigation measures for other hazard which may have a higher probability of occurrence. The older structures present a challenge for security in terms of modifications, and the issues of aging are not the same as for security.

### 3.1.7 Summary

In summary, whether we are addressing aging infrastructure issues, measures to deal with earthquakes, wind, floods or terrorism, there may be things in common, but most likely each situation will be unique and the solutions quite different. There are many entities conducting transportation R&D, and it is essential that those who make decisions on how resources are allocated have greater awareness of the issues involved and general awareness of what is being conducted. There needs to be general awareness of issues by agency leaders; necessary level of technical expertise in agency personnel; necessary interagency relationships and sufficient resources to properly close the needs gap.

### 3.1.8 References

Duwadi, S. R.; Lane, S.N; Ralls, M.L. Editors; *Enhancing Bridge Performance Workshop Report*, American Society of Civil Engineers, Structural Engineering Institute, February 2008. [http://content.seinstitute.org/files/pdf/ASCE-SEIEnhancingBridgePerformanceWorkshopReport\\_FinalVersion\\_12-08.pdf](http://content.seinstitute.org/files/pdf/ASCE-SEIEnhancingBridgePerformanceWorkshopReport_FinalVersion_12-08.pdf)

*ASCE Report Card for America's Infrastructure*, 2009, American Society of Civil Engineers, [www.infrastructurereportcard.org/](http://www.infrastructurereportcard.org/).

## 3.2 Suspension Bridge Cables: 200 Years of Empiricism, Analysis and Management

*Dr. Bojidar Yanev, Executive Director, Bridge Inspection & Management, New York City DOT*

### 3.2.1 Empiricism and Theory

**E**ngineering structures must succeed in three domains: the theoretical, the physical, and the social. The operating tools of these domains are abstract analysis, empirical application, and economics. Whether successful or not, the required synthesis is particularly spectacular in long-span bridges, among which the suspension ones are the undisputed champions. Suspension bridges using natural fiber ropes have existed since prehistoric times, but their modern history begins

with iron chains. The first United States patent for a bridge suspended on iron chains was awarded to James Finley (1762 - 1839), a land-owning judge, in 1808. The patented bridges had a stiffened roadway, designed to carry pedestrians and horse carriages cost-competitively over spans up to 76 m. Judge Finley arrived at his modest but reliable bridges by experiments. His ‘empirico-inductive’ understanding of the suspension structural scheme inspired him to forecast that ‘something further may be done in the art of bridge building than has yet been accomplished’ (Karnakis, 1997, p. 53). Finley appears to have been fully aware of the need for a satisfactory analytical model.

In 1823 Navier (1785 - 1836) formulated suspension bridge theory in his *Memoire sur les Ponts Suspendus*. The analysis, design, and construction of suspension bridges in France is concisely and comprehensively reviewed in LCPC/SETRA, 1989. In 1827 Navier’s extensively analyzed 170 m span at Pont des Invalides, barely completed, had to be dismantled, primarily due to the malfunctioning anchorages.

Ever since, analysis and experiment have relentlessly challenged and stimulated the art and science of bridge building. Marc Seguin (1786—1875) complained that Navier treated ‘theoretical notions or mathematical solutions [as] a priori admissible’ (Karnakis, 1997, p. 269). Nonetheless, further developments, including Seguin’s, owe much to the theoretical backing of Navier’s *Memoire*. In the *American Railroad and Mechanics Magazine* of April 1, 1841, No. 379, Vol. XII, J.



Over the last 200 years, suspension bridges have been at the forefront of all aspects of structural engineering, including empirical and theoretical studies, and construction and lifecycle management. Their spans have grown from 50 to 2,000 meters, with designs for 3,000 meters under consideration. The key elements of modern suspension bridges are their cables, the evolution of which this paper examines. The author identifies critical improvements and setbacks, and describes the most recent developments in cable design, maintenance, and inspection. Conclusions regarding suspension bridges and engineering structures in general are drawn.

**INFRASTRUCTURE TYPE:** Suspension bridges



Roebing (1806-1869) argued that ‘the successful introduction of cable bridges into the United States would require the combination of ‘scientific knowledge and practical judgment of the most eminent Engineers.’ Roebing proved singularly capable of providing both, along with the organizational abilities required for manufacturing the high strength galvanized cable wires and the procurement of the financial backing his monumental bridges needed. Thus his Brooklyn Bridge in New York City (main span 487 m), completed in 1883 by his son and daughter in law, Washington and Emily Roebling, is carrying more than 80,000 passengers daily in 2009. Billington (1983) concluded that the integration of theory and practice achieved by Roebing and Eiffel (1832 - 1923) elevated structural engineering into an art. One disadvantage of great artistic accomplishments, however is that they do not lend themselves to standardization and mass production. Engineering practice, in contrast, must deliver utility repeatedly, reliably and cost-competitively. This apparent contradiction is demonstrable in bridge design where spans shorter than 150 m are subject to detailed specifications by AASHTO (American Association of State Highway and Transportation Officials), but the longer ones are not. Neither are cable-supported bridges of any length. Thus in the domain of the foremost structural accomplishments, failures and successes jointly advance the state of the art.

### 3.2.2 Failure: The Ultimate Test

No planned engineering experiment can match the social and professional impact of an unintended structural collapse. The shock value of the suddenly perceived ignorance and the usually considerable losses add up to a lesson easy to understand and remember by non-professionals. Despite the advances in abstract analysis and controlled testing, failures have the most conspicuous influence on bridge design, construction, and management. A database compiled at Cambridge University and later updated with input from other sources lists more than 400 failures beginning with the third Rialto Bridge over the Canale Grande in 1444. The causes are attributed as follows:

No planned engineering experiment can match the social and professional impact of an unintended structural collapse.

Cause:	Nat. Hazard	Design	Impact	Error	Overload	Ignorance	Deterioration	Vandalism
Percent (%)	27	21	17	12	10	9	3	1

Bridge failures in the United States during the period 1966—2005 are attributed to various respective causes in Figure 3-4. Natural hazards dominate both listings. By far the leading causes are hydraulic-related.

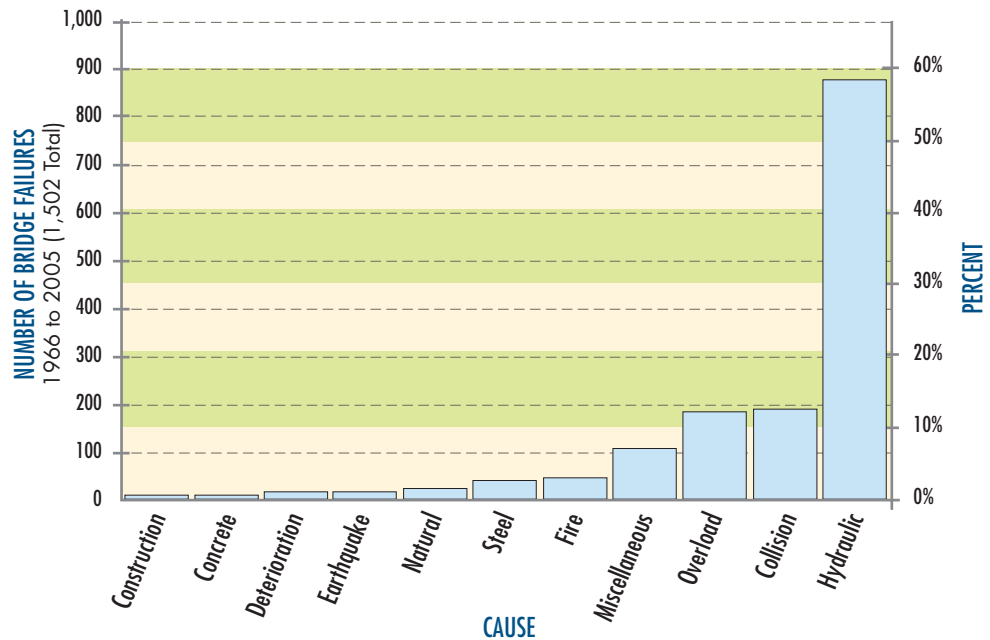

Figure 3-4. Bridge failures in the United States 1966—2005 (courtesy STV Engineers)

Suspension bridges represent a small portion of the total bridge population; however, they are essential to transportation, and at the forefront of engineering innovation. Consequently their failures are critically important not only quantitatively but also qualitatively. H. Petroski (1993) regards failures are inherent in the creative process of bridge design and construction. Citing earlier work by Sibly and Walker in England, he argues that each innovative bridge form is developed by trial and error until its limits are surpassed and spectacular failure occurs. Only then does theory catch up with the practice and fully explains the structural behavior. By this estimate, the still evolving cable-stayed bridges should be viewed with particular concern. A few popular examples may add a historic perspective to this controversial subject.

### 3.2.2.1 19th Century cable-supported bridges

Nineteenth Century engineers experimented with both suspension and cable-stay bridges using both ropes and chains. The more complex dynamic behavior of these structures resulted in greater lapses in the designer's knowledge, and hence, the many failures under wind loads, as well as those caused by rushing crowds.

The cable-stayed bridge at Dryburgh collapsed in a gale storm in 1818, 6 months after it was completed. Samuel Brown's Brighton Chain Pier was destroyed by a storm in 1836. The landmark bridge crossing the Menai Straights in England with a main span of 177 m was designed by Thomas

Telford (1757 - 1854) and completed in 1826. The bridge chain suspension system never failed, but high winds caused significant damage and repairs were necessary at least twice.

With a main span of 308 m, Charles Ellet's (1810 - 1862) Wheeling suspension bridge over the Ohio River was the world's longest. Ellet had to repair it after it was destroyed by wind in 1854. Roebling later replaced it with his hybrid suspension/stay system. That system created enduring dynamically stable structures without a rigorous theoretical backing. Theoretical advances in the 1920s enhanced suspension bridge analysis. Roebling's semi-empirical hybrid system was stripped of the diagonal stays and the stiffening trusses, ultimately producing the aerodynamically unstable Tacoma bridge.

### 3.2.2.2 Tacoma Bridge (1940)

The bridge, in Washington State, was designed by the early proponent of large displacement theory Leon Moisseiff (1872—1943), renowned for his contributions at Manhattan Bridge in New York (Figure 3-5) and the Golden Gate in San Francisco. Distinguished by a relatively narrow cross section and longitudinal stiffening girders in lieu of the traditional trusses, it collapsed under wind loads (Figure 3-6) after months in service.

The failure is attributed to ignorance of the dynamic phenomenon later recognized as flutter. Yet flutter had already been identified by Von Karman (1940) in research on aircraft wing stability. Thus the ignorance could be perceived as design error. The new Tacoma suspension bridge has a deep stiffening truss. In 1937 Othmar Ammann (1879—1966) won an award for the design of the Whitestone Bridge in New York City (Figure 3-7). Following the collapse of the Tacoma, the very similar Whitestone was stabilized with stiffening trusses, diagonal stays, and a tuned mass damper mid-span. None of these enhancements proved conclusive. They have been removed or are reassessed during a current structural reconfiguration.



Figure 3-5. Brooklyn, Manhattan and Williamsburg bridges

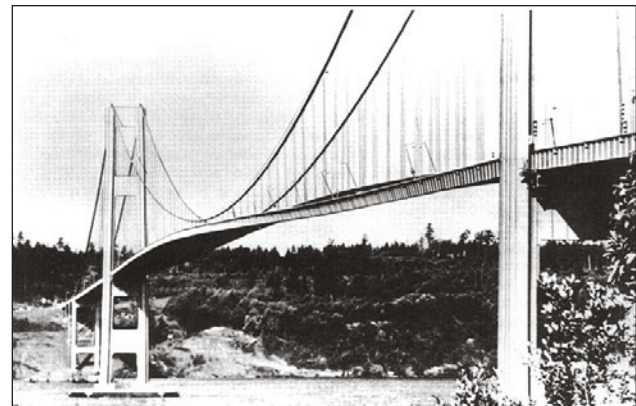

Figure 3-6. Tacoma Narrows Bridge



Figure 3-7: Whitestone Bridge in the 1980s



Figure 3-8: Cracked eye-bar of suspension bridge

### 3.2.2.3 Silver Bridge (1967)

The collapse of this bridge over the Ohio River at Point Pleasant is attributed to ignorance (of fatigue fracture). Nonetheless, defects amounting to poor quality control during construction were observed in the steel eye-bars (Figure 3-8).

Furthermore, the non-redundant 2-eye-bar suspension chain has been entirely discredited, leading to the controlled demolition of a similar structure over the Ohio River at St. Mary's, West Virginia. That consequence implies a design error. Impressed by the collapse, which took 46 lives, the United States Senate mandated biennial bridge inspections, clearly recognizing that the lack thereof is a management deficiency. The outcome was the National Bridge Inventory (NBI), which currently contains data on more than 600,000 vehicular bridges, and more than 100,000 culverts.

### 3.2.2.4 Partial Failures

Partial failures (also known as near misses) are easily overlooked and their lessons are more likely to go unnoticed. Particularly deterioration is blamed for only 3% of the failures in the Cambridge database. Yet this phenomenon is recognized as widespread and the losses it has

caused are vast but not quantifiable, because they do not include obvious fatalities. As a result, deterioration-related failures are among the most recent ones and their number appears to be on the rise. As errors, they can be traced to neglected maintenance, as well as to the design which did not anticipate such neglect. Since deterioration is a relatively slow process (compared to natural hazards, fractures and losses of stability for example), its effects have been intercepted by inspections and arrested by rehabilitations. Thus partial failures have become increasingly significant.

Both Pont de Tancarville and Pont d'Aquitaine in France had their suspension cables replaced without incident following the discovery of breaks caused by corrosion. The original cables had no wrapping and consisted of helical non-galvanized strands. The 4 cables of the Williamsburg Bridge (1903, 488 m main span) in New York City

Deterioration-related failures are among the most recent ones and their number appears to be on the rise.

(Figure 3-5) were rehabilitated in the 1990s after a long debate over their viability. The cables, each consisting of 7696 non-galvanized parallel 5 mm wires grouped in 37 strands, were rapidly corroding. During the rehabilitation, several strands were re-anchored, many broken wires were spliced, corrosion-inhibiting oil was added, and water-proofing was supplied in the form of new wrapping.

Many suspenders and stay-cables have broken, however the effect of these failures has been localized by redundancy. In 1981 one of the diagonal stays of the Brooklyn Bridge (Figure 3-5) broke due to corrosion and killed a pedestrian. The entire system of suspenders and stays was subsequently replaced. A suspender broke at the first Bosphorus Bridge in 2004 and another one was burned by lightning at the Rion—Antirion Bridge in 2006. Neither incident required significant traffic interruptions. Suspender and stay replacement is recognized as a periodic necessity. The suspenders of Manhattan Bridge have been replaced at least once and will be replaced again under a pending contract. Traditional suspenders and diagonal stays are helical strands.

### 3.2.2.5 General Observations

Structural failures in general do not lend themselves to purely quantitative assessments. To the inability to quantify loss of life and other user costs, there are difficulties with evaluating the loss of public and professional confidence. Forensic investigations are post-event efforts to eliminate failure causes. Once identified such causes are perceived as vulnerabilities requiring special treatment. The identification and elimination of vulnerabilities is a perpetual task of management depending on every specific circumstance, however some common characteristics have emerged (also discussed in Yanev, 2007). Failure causes have been classified according to a variety of criteria including the following:

Structural failures in general do not lend themselves to purely quantitative assessments.

#### **Event-based.**

- The classifications of the Cambridge database and Figure 3-4, cited earlier are of this type, however they also refer to the structural type and material.

#### **By the mode of material non-performance.**

- This classification would identify metal fatigue and fracture, corrosion, corrosion fatigue, ductile failure, residual stress, yield, shear, concrete fatigue, chemical reactivity, temperature, and so on. Although helpful, this classification misses certain vulnerabilities, such as instability. Thus another classification

becomes necessary, distinguishing between local and global behavior. Whereas a material failure is by definition local and can lead to global consequences, instability is a global failure which causes local material non-performance.

**‘As designed’ and ‘not as designed’ modes** are suggested by Thoft-Christensen and Baker (1982).

- The failure of the deck truss bridge carrying Rte. I-35-W in Minneapolis on Aug. 1, 2007, caused by overstress of poorly dimensioned gusset plates, is in the ‘as designed’ mode. These are practical failures resulting from poor execution. The failure of the Tacoma bridge, caused by the hitherto unknown flutter is in the ‘not as designed’ mode. Such failures point o theoretical deficiencies.

Yanev (2007) recommended investigating the causes of failures arising from the various phases of the bridge life-cycle, including design, construction, maintenance, and operation. This approach quickly reveals that failures occur when each phase excessively relies on the others, whereas it should have assumed responsibility as if it were critical. For example after the collapse of the bridge over the Schoharie Creek (New York State, 1987) caused by scour, it was concluded that the bridge could have survived if underwater inspections had been more effective, however the collapse could have also been prevented by selecting a longer span with piers out of the channel.

No failure classification can be entirely independent, and neither are the revealed vulnerabilities. A redundant approach to identifying vulnerabilities by various partially overlapping criteria has a better chance of capturing all possibilities. New York State, for example, has established screening procedures for the following vulnerabilities: hydraulic, seismic, overload, steel details, concrete details, collision, and sabotage.

Significant failures are usually caused by combinations of two or more vulnerabilities.

Significant failures are usually caused by combinations of two or more vulnerabilities. In all of the preceding examples, design, construction, and maintenance might have intervened to avert the disaster, if they had seen their own role as the most critical. The investigation following the collapse of the Sungsu truss bridge in Seoul in 1994 concluded that the bridge had been ‘poorly designed, built, maintained, and used.’ The Cambridge database attributes the incident to ‘human error.’ ‘Errors’ would be more appropriate, because it aptly underscores the failure of life-cycle management.

Significant failures invariably exhibit a discontinuity in the process, in the product or in both. A common one is between experience and theory. This can be expressed as an over-reliance of each on the other or as an ignorance of each about the other. For example, the rationale justifying the use of non-galvanized high strength cable wires on the Williamsburg Bridge was summarized as follows: 'If the wires are maintained dry, they do not need zinc coating. If not, it will not save them in the long term.' This reasoning may appear sound, yet it lacks both the practical knowledge of life-cycle cable performance and a theoretical model of wire deterioration. The opposite solution would have been correct: wires should have been locally protected by galvanization, whereas the cable should have been globally protected by superior wrapping. As in all discontinuities, the remedy is redundancy.

Failures can be traced to deficiencies in both the engineered product and the managed process. Thus the gap between theory and practice is matched by an equally detrimental gap between the increasingly diverging professions of engineering and management. The current trend is to rely on engineering competence during the design and construction of the product (in this case the bridge) and to assign the process of its operation to a management, guided primarily by economic considerations. The latter typically minimize initial costs, while shortening the structural life-cycles and increasing the demand for future expenditures.



Failures can be traced to deficiencies in both the engineered product and the managed process.

Thus the gap between theory and practice is matched by an equally detrimental gap between the increasingly diverging professions of engineering and management.

Most simplistic and yet inevitable are the failure assessments according to the amount of damage and the responsibility. All structural failures are to some extent attributable to management and this is reflected in the way society reacts to them. The failure of the Silver Bridge was at the origin of the NBI and the biennial bridge inspection program, the partial failure of the Williamsburg bridge led to the re-establishment of the Bridge Division at the New York City Department of Transportation, the numerous failures caused by earthquakes in California and in Japan have influenced the design and construction of bridges worldwide, the collapse of the I-35-W bridge in Minneapolis has stimulated the use of non-destructive structural monitoring techniques. Appropriate as these measures are, they remain reactive, whereas the purpose of engineering management and design is to anticipate. The history of suspension bridge cables offers examples of such anticipation.

### 3.2.3 Suspension Bridge Cables

The temporary closure, in 1988, and subsequent rehabilitation of the Williamsburg Bridge attracted much attention to the condition of suspension cables. (That project is currently concluding at a total cost of approximately \$US 1 billion.) The affected structures are among the oldest, largest, and most historically significant nationwide. The Cincinnati - Covington Bridge was opened to traffic in 1867, the Brooklyn Bridge - in 1883, Williamsburg - in 1903 and Manhattan - in 1908. Ten major suspension bridges, including Ammann's George Washington (1931 and 1957, 1068 m main span), Verrazano (1964, 1300 m main span), Triborough, Whitestone, Throg's Neck and the East River bridges are in the New York Metropolitan area. During the 1990s the author co-sponsored a comparative survey of these structures along with all respective owners. The resulting report by Columbia University summarized cable conditions, design, construction, and maintenance practices. Key findings were presented by Betti and Yanev (1999).

The National Cooperative Highway Research Program (NCHRP) at the Transportation Research Board (TRB) expanded the study to all parallel wire cable-supported bridges nationwide and published NCHRP Report 534 by Mayrbaur and Camo (2004) of Weidlinger Assoc. The report addressed twenty nine suspension bridges, constructed in North America by the aerial spinning method up to the year 2000 and two (Newport, R.I. and William Preston Lane Jr., MA.) built with shop-fabricated parallel wire strands. The twenty one (shorter) spans supported by helical strand cables were not considered in this study. NCHRP Report 534 recommended further investigation of the behavior of cables under controlled and actual field conditions.

#### 3.2.3.1 Wires: Condition, Deterioration, and Failure

The replacement of suspension chains and eye-bars with parallel wires or helical strands radically improved the *internal redundancy* of suspension cables. The wires in the investigated cables (Williamsburg excepted) are galvanized, have an approximately 5 mm diameter and their strength is around 1515 mPa. In a load-free state, they assume a curvature with roughly 1 m diameter, which indicates their state of bending under working conditions. The non-galvanized wires of the Williamsburg Bridge failed when corrosion reduced their cross-section. This mode of wire failure is atypical, as well as relatively simple and has not attracted much interest. Failures of non-galvanized helical strands have been reported in detail by Virlogeux (1999) and Kretz et al. (2006), along with the ensuing cable replacements.

The replacement of suspension chains and eye-bars with parallel wires or helical strands radically improved the *internal redundancy* of suspension cables.



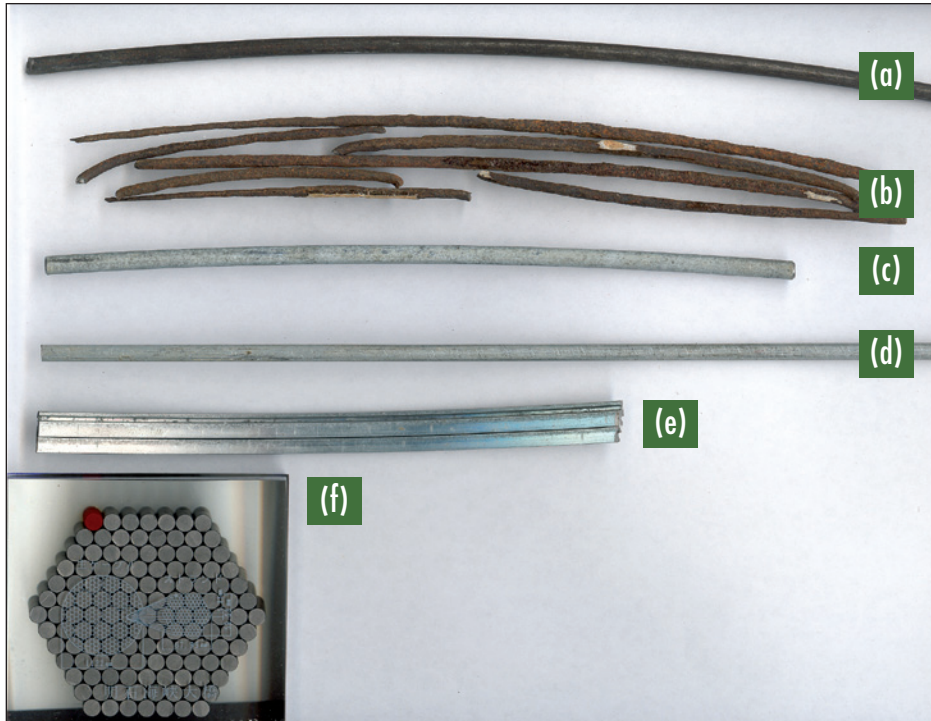

Figure 3-9.  
Wire breaks and corrosion  
stages (NCHRP Report 534,  
Mayrbaurl and Camo, 2004)

In contrast, high-strength galvanized wires have proven susceptible to ‘flat and invert’ breaks, and the rarer spiraling breaks, as in Figure 3-10 (Mayrbaurl and Camo, 2004).

Flat breaks are believed to develop as follows:

- The approximately 0.05 mm zinc coating oxidizes and fails over a small area of the wire surface.
- The exposed steel begins to oxidize, causing surface irregularities, such as pitting and, consequently, stress concentration.
- Cracks develop transversely to the wire surface, further concentrating the stress.
- The cracks propagate at an angle towards the center of the wire until the area is critically reduced and the wire breaks normally to the axis. The sequence raises the following critical questions:

*Quantifying and qualifying wire corrosion.*

The strength evaluation of a cable is based on visual inspections which, in turn must estimate the state of corrosion. To facilitate these estimates, 4 stages of wire corrosion (Figure 3-10) were described by Hopwood and Havens (1984) as follows:

- Stage 1 - Spots of zinc oxidation on the wires;

- Stage 2 - Zinc oxidation on the entire wire surface;
- Stage 3 - Spots of brown rust covering up to 30% of the surface of a 3 to 6 inch (75 to 150 mm) length of wire;
- Stage 4 - Brown rust covering more than 30% of the surface of the 3 to 6 inch length of wire.

Despite the lack of phenomenological backing, this rating system endures, as do all visual inspections. NCHRP Report 534 proposed a model linking the visual findings, classified in the 4-stage system to an estimate of the number of cracked and broken wires, and ultimately, the cable strength.

*Does the oxidized zinc contribute the embrittlement of the steel?*

Mayrbaurl and Camo (2004) point out that much depends on the further reactions of the resulting zinc oxide (ZnO). Those, in turn depend on the environment and, particularly on the type of humidity. Zinc carbonate ( $\text{ZnCO}_3$ ) can form an effective protective film, whereas zinc hydroxide ( $\text{Zn(OH)}_2$ ) easily dissolves, leading to the formation of carbonic acid ( $\text{H}_2\text{CO}_3$ ), which becomes a source of embrittling hydrogen.

*Is there a threshold level of zinc depletion and steel corrosion beyond which cracks begin to occur spontaneously?*

To some extent that would depend on the level of stress in the 'as-built' cable. Modeling that stress however, besides relying on the uncertain state of the unstressed wires, also depends on their stress level, subject to different uncertainties.

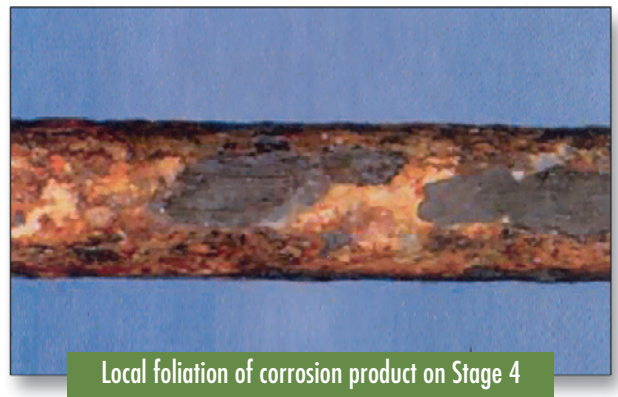
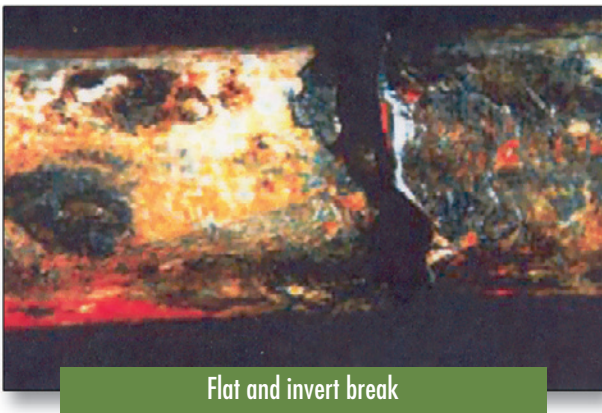
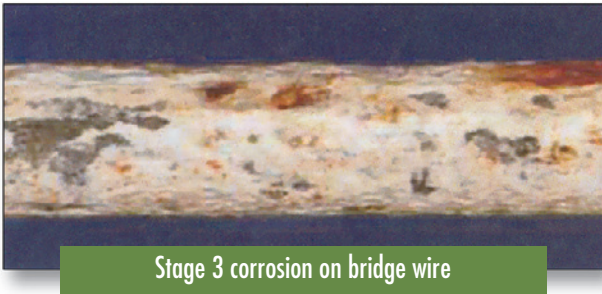

Figure 3-10. Wire breaks and corrosion stages

SOURCE: NCHRP REPORT 534, MAYRBAURL AND CAMO, 2004

### 3.2.3.1.1 Wire Stresses

Suspension cable wires are not in uniaxial tension as is generally assumed in calculating safety factors. High-strength wires are manufactured by the cold-drawn method by extruding them through progressively smaller

Suspension cable wires are not in uniaxial tension as is generally assumed in calculating safety factors.

openings and thus modifying the molecular shape of the original mild steel. Eventually the wires of the desired diameter (roughly 5.1 mm) are dipped in molten zinc for protection against corrosion. The galvanized wires cool off in a permanently curved shape with a diameter of approximately 2 m. Consequently, the wires experience bending

stresses in order to conform to the shape of the cable. Eliminating a curvature with radius  $R$  induces in a wire with radius  $r_{wire}$  bending moment  $M$  as follows:



$$M = E I / R \quad (2)$$

The corresponding maximum bending stress  $\sigma$  is:



$$\sigma = M / S = E r_{wire} / R \quad (3)$$

where:  $I = \pi R^4 / 4$  is the section moment of inertia.

$S = I / r_{wire}$  is the section modulus.

Suspension bridge wires regain some of their original curvature if they are extracted from a cable, even after many years of service. During laboratory tension tests, cracks invariably develop on the concave side of the wire, e.g., where the straightening would cause tension. A complex bending stress develops in the cable wires also in the anchorages where they must turn around sheaves of relatively small diameters, as in Figure

3-11a. That behavior is among the reasons leading the designers of the most recent suspension bridges, for instance in Japan, to use the prefabricated straight wire strands, originally developed under a U.S. patent (Figure 3-11b).



Suspension bridge wires regain some of their original curvature if they are extracted from a cable, even after many years of service. During laboratory tension tests, cracks invariably develop on the concave side of the wire, e.g., where the straightening would cause tension.

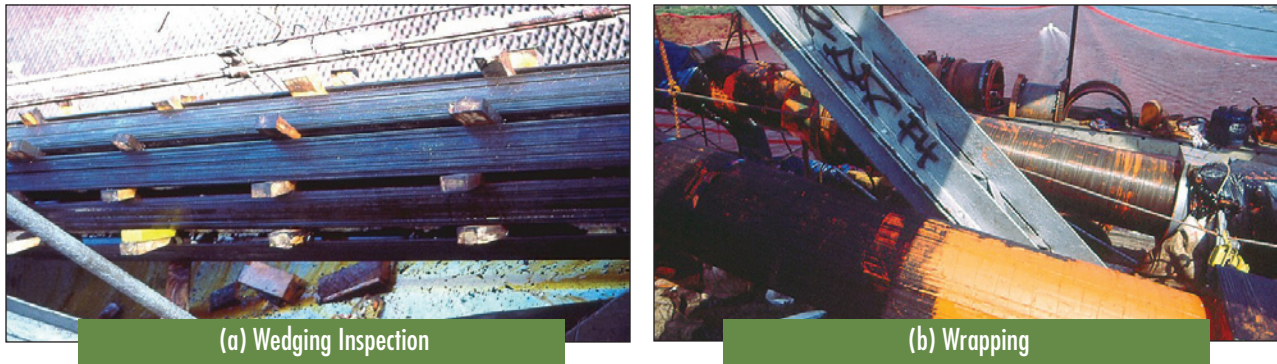

Figure 3-11: Examples of suspension cable during (a) wedging inspection and (b) wrapping

### 3.2.3.1.2 Residual Stresses

Residual stresses would be caused by the extrusion process and by the hot-dipping into zinc. The steel surface under the zinc is irregular.

All cracks are found on the side of the wire where straightening during construction would have produced tension. Mayrbaurl and Camo (2004) estimate (based on X-ray diffraction tests) that the straightening produces bending stresses of up to + 36 ksi (240 mPa). Theoretically the values can reach beyond the yield point of the steel. Residual stresses are also caused by the hot dipping in the zinc (along with some surface imperfections). Therefore, the possibility that cracks may exist in the steel before the zinc coating fails cannot be excluded.

### 3.2.3.2 Cables: Condition, Deterioration, Maintenance, and Repair

#### 3.2.3.2.1 Design and Construction

Over the 20th Century parallel wire suspension cables underwent the following changes:

- *Suspension bridges started using 2, rather than 4 cables.* Examples of the 4 cable configuration include the East River bridges, the George Washington and the Verrazano in New York City. Notable among the 2 cable bridges are the Ambassador, Macinac (1,158 m), Bay Bridge, and Golden Gate (1,280 m). Four cables were originally contemplated at the Akashi-Kaikyo; however, the 2 cable cross-section was selected because of its superior aerodynamic properties. The proposed 3,000 m span at the Messina Straights assumes 4 cables. The global redundancy of the 4 cable configuration may have saved some bridges from demolition. For his bridge

Suspension bridges started using 2, rather than 4 cables.

at Oporto, D. Steinman anticipated a second pair of cables carrying added traffic. That modification was completed in the 1990s. At Pont de Tancarville the two original cables were replaced by two pairs, allowing for a future replacement of each pair by a single cable at the original location (Virlogeux, 1999).

- *Suspenders, once spaced at roughly 7 m, are now spaced at about 20 m.* The increased distance between suspenders affects primarily their own behavior as well as that of the bridge superstructure. The cables, however, are also influenced in at least two ways. The cable bands which improve the behavior of broken wires and the compaction of the cable are reduced. Consequently they transmit greater concentrated loads to the wires. As the distance between the cable bands increases so does the bending moment introduced by them into the cable.

Suspenders, once spaced at roughly 7 m, are now spaced at about 20 m.

The corrosion protection of suspenders is paint; stays are protected in various encasements, primarily cement grout. The limitation of the latter method, however have prompted Japanese designers to use parallel wire suspenders and stays with rubber vulcanization, as at the Akashi - Kaikyo and Tatara Bridges.

#### 3.2.3.2.2 Wind Loads

The aerodynamic susceptibility demonstrated by Tacoma and other suspension bridges led to extensive testing of models of all major suspension and cable-stayed bridges in wind tunnels. For the Akashi—Kaikyo Bridge, a 1/100 scale model was tested in a wind tunnel built expressly for that purpose.

The inclined suspenders used on many bridges in Europe, including the record-breaking Humber in Wales (1981, 1,410 m main span) showed a tendency for fretting and fatigue. After relatively short useful lives, such suspenders were replaced at the Severn and Brotonne Bridges while their sockets were modified. Water on the surface of stays was found to modify their aerodynamic response, causing the so-called galloping oscillations. The phenomenon is mitigated by surface obstructions to running rain water. Dampers are added on longer suspenders and stays.

Stresses are not uniformly distributed across the section of a suspension cable, however the actual distribution is not known.

#### 3.2.3.2.3 Stress Distribution

Stresses are not uniformly distributed across the section of a suspension cable, however the actual distribution is not known. Attempts to obtain a field measurement are made by cutting wires and measuring their retraction. That retraction, however, is

constrained by the friction with adjacent wires and is therefore limited to the so-called *clamping length* of the wires. The clamping length is very important in estimating the contribution of broken wires at longer distances from the fracture points. It is often assumed that tension in a broken wire is restored over the distance of 3 cable bands. Apart from the hypothetical nature of that assumption, it clearly depends on the distance between cable bands and on the level of compaction of the cable. Thus the local condition of the wires must be assessed jointly with the global condition of their totality as a cable.

*Safety factor* is a somewhat discredited term, because of the uncertain assessments of both stress and resistance levels. Nonetheless, the ratio between the ultimate load of the cables at yield and the maximum expected load during its service has declined from over 4 to 2.2. It is argued that 90% of all loads on long-span bridges consist of the relatively constant dead load. Furthermore, the effective stiffness of the cables increases proportionally to the cube of the stress divided by the square of the span length. The formula, attributed to Tischinger and to Ernst, can be written as in Eq. 1.

$$1/E_{ef} = 1/E + (\gamma L)^2 / (12 \sigma^3) \quad (1)$$



where:  $E_{ef}$  = effective modulus of elasticity of the cable;

$E$  = modulus of elasticity of the steel;

$L$  = span length;

$\gamma$  = specific weight of the cable;

$\sigma$  = stress in the cable.

Thus longer spans achieve the desired stiffness at the expense of higher stresses in the wires, implying an increased likelihood for ‘stress-corrosion’ and hence a lower tolerance for deterioration.

*Cable protection* once consisted of linseed oil introduced into the cable voids, a red lead paste coating over the wires, plastic wrapping over the lead, spiral wire wrapping on top and paint over the wires (Figure 3-12b). Because of environmental objections to lead, it has been occasionally substituted by zinc paste. The long-term effects of this modification are yet to be observed, because lead is passive whereas zinc oxidizes. The benefits from the spiral wire wrapping have been disputed and it has been eliminated at some bridges.

Longer spans achieve the desired stiffness at the expense of higher stresses in the wires, implying an increased likelihood for ‘stress-corrosion’ and hence a lower tolerance for deterioration.

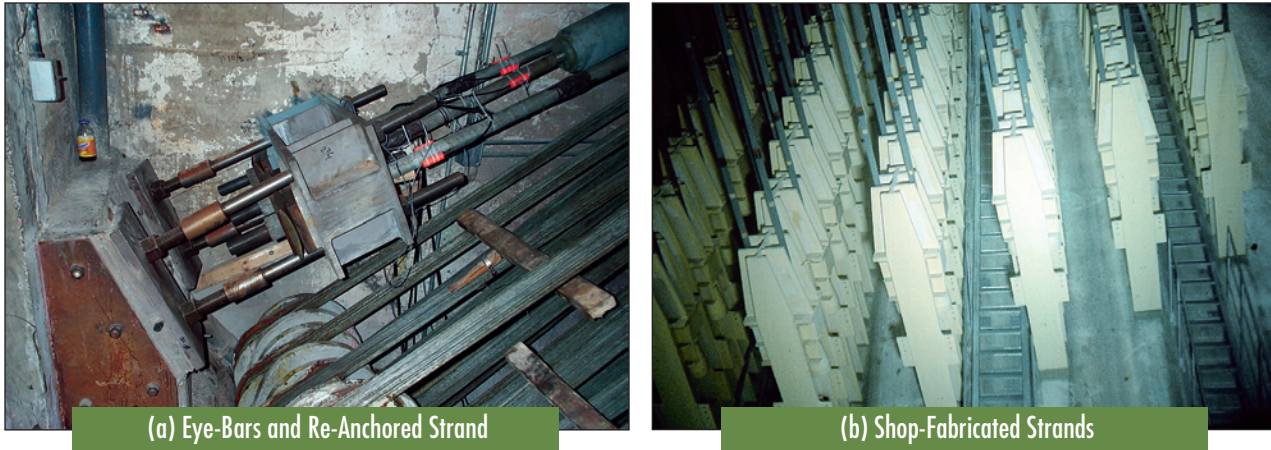

Figure 3-12: Examples of anchorages with (a) eye-bars and re-anchored strand and (b) shop-fabricated strands

Compaction is one form of cable protection, because it impedes the penetration of water and increases the clamping effect.

Compaction is one form of cable protection, because it impedes the penetration of water and increases the clamping effect. Air-spinning achieves a relatively uneven compaction of 75%-80%. In a perfectly compact cable all wires except the external ones are in contact with 6 adjacent wires, forming a hexagon. For  $T$  perfectly compacted concentric layers, the net wire to gross cable ratio of areas can be computed as in Eq. 4.

$\sqrt{f}$  Equation

$$2\pi r^2 [3T(T+1) + 1] / r^2 [(2T+1)^2 33/2] \approx 1.211 \times 3/4 \approx 0.907 \quad (4)$$

In cables built by the traditional air-spinning method 80% compaction is realistic, but variations are quite broad.

### 3.2.3.3 Anchorages

The anchorages of air-spun cables (Figure 3-12a) feature three critical transitions:

- From a compacted cable to splaying strands. In this area wires no longer have the benefit of clamping effects and are fully exposed to humidity. As a result entire strands have been lost to corrosion in anchorages, and re-anchoring has been necessary (Figure 3-11a).
- From strands to eye-bars. The bending over the pins of the eye-bars can cause yield in the wires, but few breaks have been noted in these areas.
- From exposed eye-bars to concrete encasement. Eye-bars corroded significantly at that juncture have been replaced by new anchoring systems, for example at Manhattan Bridge.



### 3.2.3.4 Uncertainty

For engineering purposes, uncertainty has been separated by ISO (1995) into randomness (for example of natural phenomena), vagueness (as in condition evaluation), and ignorance (of actual conditions). Ang and De Leon (2005) recognize aleatory and epistemic uncertainties, associated with random natural variables and deterministic risk-informed decisions, respectively. In either classification, all types of uncertainties are present in bridge cables. Report NCHRP 534 treats probabilistically the key parameters of the cable model as follows:

- *Wire condition.* Acoustic emission has been used to detect wire breaks of cables in use. The labor-intensive and intrusive unwrapping and wedging (Figure 3-12a) remains the only reliable source of information about the condition of the wires. NCHRP 534 proposes methods of projecting the number of wires in each of the four states, based on the limited findings of such inspections. The extrapolations depend on the sizes of the cables and the sample, and the observed conditions.
- *Cable strength.* NCHRP 534 proposes three models as follows:
  - *Ductile wire.* Strain increases incrementally. A wire reaching yield carries the corresponding stress until the rest of the wires reach that point and they all fail simultaneously. The cable strength is the average strength of the wires multiplied by their number. This model has a limited application to cables (possibly such as those of the Williamsburg) where loss of section, rather than cracking is critical.
  - *Brittle wire.* Each wire fails at its tensile strength limit. A step-wise stress-strain diagram results, as the number of wires declines. The model tends to underestimate the cable strength by as much as 20%.
  - *Limited ductility model.* This more elaborate model recognizes that when the first wire breaks, the force in the remaining wires does not change because the change in the overall strain is negligible. As the ratio of broken to active wires grows, so does the *strain rate*. The process is dynamic.

### 3.2.3.5 Innovations and Trends

The described experiences have inspired a number of innovative choices for the new suspension bridges worldwide. The two cables of the Storabaelt Bridge in Denmark (1996, main span 1,624 m) were built by the traditional air-spinning method with 18,648 wires of diameter 5.37 mm and minimum strength of 1,570 N/mm<sup>2</sup> (Figure 3-9C).

In Japan, new cables are built with shop-fabricated strands, composed of 127 straight galvanized wires with yield up to  $1800 \text{ N/mm}^2$  (Figure 3-9d and f). The shop-fabricated cable strands are anchored with sockets as in Figure 3-12b. Most anchorages (including old ones) are being equipped with de-humidification systems. On several record-breaking bridges in Japan, such as the Kurushima and Akashi-Kaikyo, managed by the Honshu-Shikoku Bridge Authority, pressurized dry air is injected under the cable wrapping (Figure 3-13).

Figure 3-13:  
Dry air injection at Kurushima  
Bridge

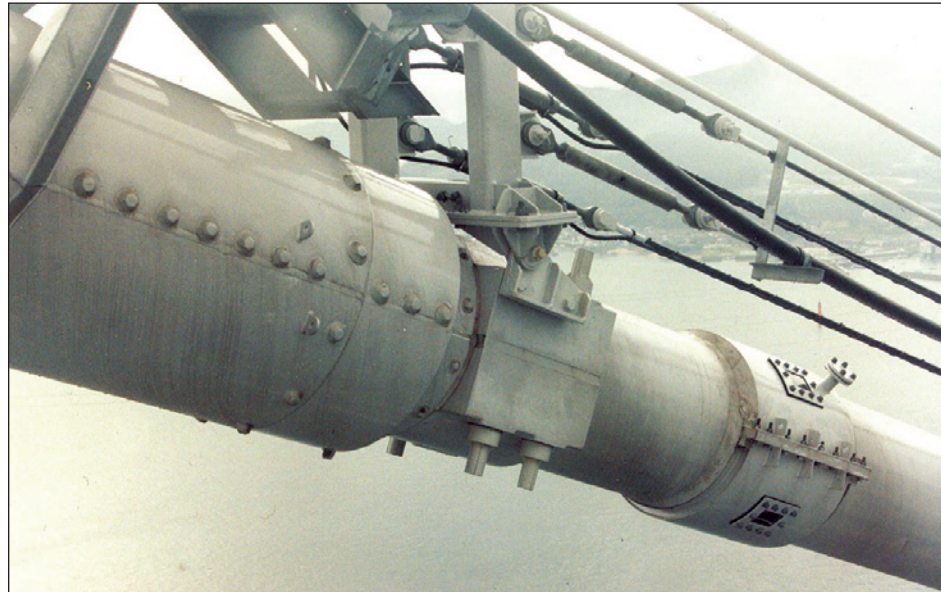

Wrapping wires are pre-formed z-shaped as in Figure 3-9e. Each of the two cables of the Akashi-Kaikyo Bridge (1998, main span 1991 m) has 290 hexagonal strands (Figures 3-9f and 3-14a). The suspenders of the Akashi-Kaikyo and the stays of the Tatara bridges in Japan consist of parallel wire strands encapsulated in rubber (Figure 3-14b). The new suspension bridges are heavily instrumented with various monitoring devices, measuring acceleration, vehicular weight, wind speed, temperature, and other environmental and structural parameters.

Wind tunnel testing has become standard practice on all suspension and cable-stay bridges, however scale models cannot fully simulate the actual structural response. Consequently, dynamic analysis must follow a redundant path, seeking acceptable convergence of analytic and experimental results, as has been the case since the origin of bridge building. The process does not stop with the completion of construction. Monitoring systems collect 'real-time' data including dynamic response, stresses, temperatures, traffic weigh in motion, wind velocity.

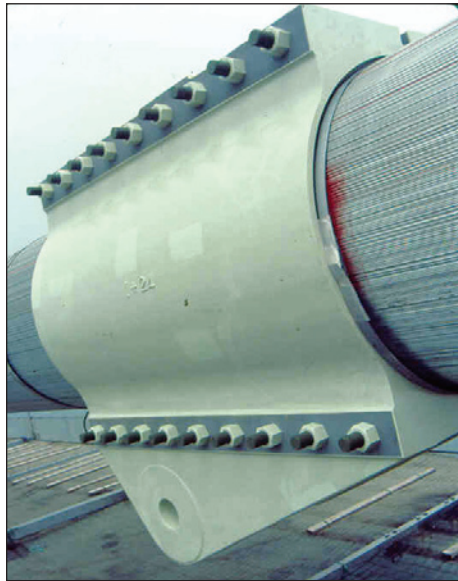

(a) Suspension cable of the Akashi-Kaikyo



(b) Stay cable of the Tatara Bridge

Figure 3-14.  
Examples of (a) Suspension  
and (b) Stay Cables

Under a current project sponsored by FHWA, Columbia University researchers are investigating the methods for non-invasive monitoring of cable condition. The research encompasses the testing of a cable model (Figure 3-15) under controlled conditions and transferring the monitoring technology to a suspension bridge for field verification. Strain gauges, custom-built corrosion sensors, fiber-optic sensors, magnetostriction sensors, acoustic emission, and other technologies are included. The objective is to identify methods suitable for monitoring the condition of cables without the need to unwrap and wedge them. The design, construction, and service of suspension bridges reach for new levels of theory and application. Once again theory must catch up with practice.

Figure 3-15:  
Cable model at Columbia  
University

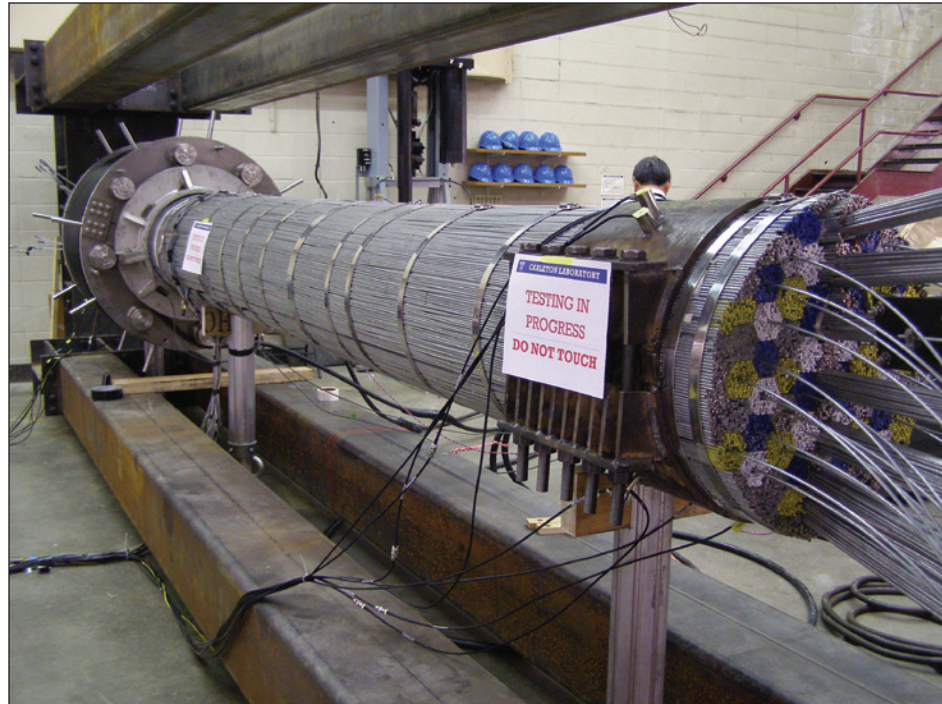

### 3.2.4 Acknowledgment

The views presented in this article are those of the author and do not express the position of any organization or agency.

### 3.2.5 References

Ang, A. H.-S. and D. De Leon (2005), *Modeling and Analysis of Uncertainties for Risk-Informed Decisions in Infrastructure Engineering, Structure and Infrastructure Engineering*, Vol. 1, No. 1, pp. 19 - 31.

Betti, R. and B. Yanev (1999), *Condition of Suspension Bridge Cables, New York Case Study*, Paper No. 99-0603, Transportation Research Record 1654, National Academy Press, Washington, D.C., pp. 105 - 112.

Billington, D. P. (1983), *The Tower and the Bridge*, Basic Books, New York.

Hopwood, T. and J. H. Havens (1984), *Corrosion of Cable Suspension Bridges*, Kentucky Transportation Research Program, Univ. of Kentucky, Lexington.

ISO (1995), *Guide to the Expression of Uncertainty in Measurement*, 2nd Ed., International Organization of Standardization, Geneva.

Karnakis, E. (1997), *Constructing a Bridge*, MIT Press, Cambridge, Mass., USA.

LCPC/SETRA (1989), *Les Ponts Suspendus en France*, Laboratoire Central des Ponts et Chaussées, Paris / Service d'Etudes Techniques des Routes et Autoroutes, Bagnaux, France.

Kretz, T. et al. (2006), *Rehabilitation and Widening of the Aquitaine Bridge*, Conference on Operation of Large Infrastructure Projects, Bridges and Tunnels, IABSE, Copenhagen.

Mayrbaurl, R and S. Camo (2004), *Guidelines for Inspection and Strength Evaluation of Suspension Bridge Parallel-Wire Cables*, NCHRP Report 534, TRB, Washington, D.C.

Petroski, H. (1993), *Predicting Disaster*, American Scientist, Vol. 81, Mar.—Apr., pp. 110 - 113.

Thoft-Christensen, P. and M. J. Baker (1982), *Structural Reliability Theory and Its Applications*, Springer - Verlag, Berlin.

Virlogeux, M. (1999), *Replacement of the Suspension System of the Tancarville Bridge*, Transportation Research Record 1654, National Academy Press, Washington, D.C., pp. 113 - 120.

Von Karman, T. and M. A. Biot (1940), *Mathematical Methods in Engineering*, McGraw-Hill, New York.

Yanev, B. (2007), *Bridge Management*, John Wiley & Sons, Inc, Hoboken, N.J.

### 3.3 Aging Cables in Suspension Bridges

*Raimondo Betti,<sup>1</sup> Ah Lum Hong,<sup>2</sup> Dyab Khazem,<sup>3</sup> Mark Carlos,<sup>4</sup> and Richard Gostaudas<sup>5</sup>*

Some promising NDT technologies for direct detection of the corrosion damage have been implemented and validated and their applicability to large suspension bridge cables has been tested. Technologies discussed in this paper include:

#### Indirect Sensing Technologies:

- LPR Sensors (Anatom Inc.)
- Coupled Multielectirc Array Sensors and BI-metallic Sensors (Corrlinstrument Inc)
- Temperature and Relative Humidity Sensors
- Fiber Optic sensors

#### Direct Sensing Technologies

- Main Flux Method
- Magnetostrictive Technology and Acoustic Emission

#### 3.3.1 Introduction

Currently, all the suspension bridge owing agencies base the maintenance of main cables mainly on information gathered from visual inspections.

Usually, a biannual inspection of a main cable consists of a complete visual inspection of the exterior of the cable. If such inspections reveal some deterioration problems, the cable is then unwrapped at a few locations along its length and is wedged into its center. A visual inspection of the internal and external wires is then performed and, when possible, a few wires are removed for laboratory testing in tension and fatigue.

Currently, all the suspension bridge owing agencies base the maintenance of main cables mainly on information gathered from visual inspections.

1 Professor, Department of Civil Engineering and Engineering Mechanics, Columbia University

2 Graduate Research Assistant, Department of Civil Engineering and Engineering Mechanics, Columbia University

3 Project Engineer, Bridge Division, Parsons Transportation Group

4 Project Manager, Physical Acoustics Corporation

5 Project Manager, Physical Acoustics Corporation

In-depth inspections of cable systems of the suspension bridges in the New York area and the broader Mid-Atlantic, bridges that have been in service for 50 years and more, have uncovered many broken wires inside the cables and at the anchorages: analyses of these wires indicate brittle fractures and extensive corrosion. These alarming findings are inexplicable yet and the reason must be found in the complex deterioration process that occurs in the wires. In fact, the failure of high-strength bridge wires manifests itself, in addition to the loss of material, in a number of related phenomena referred to as stress corrosion, corrosion cracking, corrosion fatigue, or hydrogen embrittlement.

These interacting and complex deterioration mechanisms make the task of determining the “actual” strength, and its variation with time, of main cables of suspension bridges extremely difficult. Methodologies currently used in design practice do not account for the actual deteriorated conditions of the wires; the use of a “ductile” model for the wires in the estimation of the residual cable strength has been proven to be valid only for new bridges and overestimates the “actual” cable strength in existing bridges.

In addition, there are overwhelming problems related to the uncertainties in the current inspections’ data since these in-depth inspections 1) are conducted only at a few selected locations along the bridge length, usually at those locations that “appear” to be in the worst conditions from a visual point of view, and 2) rely on the judgment of the inspector. The effectiveness of various methodologies to estimate the remaining cable strength, however, depends on the reliability and completeness of the information extracted during inspections. Unfortunately, current visual inspections can provide neither an adequate amount nor sufficiently reliable data, pointing to the need for innovative Non-Destructive Testing (NDT) and sensing technologies that, either directly, or through the measurement of related variables (i.e., temperature, acidity, humidity, etc.), can provide an immediate, comprehensive and reliable assessment of cable conditions and their evolution with time.



This paper presents an innovative monitoring system to assess the internal conditions of suspension bridge cables.

An integrated methodology that uses state-of-the-art sensing capabilities and direct and indirect Non-Destructive Testing (NDT) technologies is developed. This technology relies on a network of sensors that can monitor the external and internal environments, as well as the corrosion rate of the wires, and is integrated with Non-Destructive Evaluation (NDE) technologies that map the cross-section for the entire length of the cable. The authors tested these technologies on a cable mock-up, 20 inches in diameter and 20 feet long, composed of 9,100 0.196-inch-diameter wires. This mock-up was subjected to 1,100 kips of tension and enclosed in an accelerated corrosion chamber. Preliminary results show that the sensor network provides consistent information on the conditions inside the cable.

**INFRASTRUCTURE TYPE:** Suspension bridge cables

The goal of this study, sponsored by the Federal Highway Administration, is to develop an integrated methodology that uses state-of-the-art sensing capabilities and NDT technologies to assess what the cable condition is. A smart sensor network, integrated with NDE methodologies that would cover the entire length of the cable, is the only accurate means for reliably assessing the condition of suspension bridge cables.

### 3.3.2 Background on Corrosion of Suspension Bridge Cables

Current inspection procedures of suspension bridge main cables mainly consist of visually inspecting the exterior covering of the cable every two years. A team of inspectors “observes” the surface of the cable protection materials and reports the findings regarding cracks and chipping of

Current inspection procedures of suspension bridge main cables mainly consist of visually inspecting the exterior covering of the cable every two years.

the surface coatings (neoprene wrapping or paint), any signs of water and “residues” leaking from the cable (mainly at cable band locations) and other indications and levels of deterioration of the wrapping/painting materials. An in-depth inspection is usually scheduled when necessary to assess the condition of the interior wires by wedging the cable at 8 radial groove positions at selected locations along the cable. The number of these locations is usually

limited to about 8 or less and the evaluation is based on a combination of heuristics and statistical considerations. However, such approaches were discovered to be deficient in uncovering the most deteriorated and weakest regions in the cables of several bridges during their full cable rehabilitation projects (Waldo Hancock, Ben Franklin Bridge, Triborough Bridge to name a few).

In Figure 3-16, the number of broken wires along the South and North cables of a centennial bridge, found during an in-depth inspection, is plotted as function of the location along the cable length. The vertical axis represents the number of broken wires while the horizontal axis indicates the panel where these broken wires were found. For panel, we define the length of the cable between two consecutive cable bands. Each cable is divided into two segments indicated by the letter W and E: W indicates the part of the cable west of the central point while E indicates the east part of the cable. For example, if we are interested in the number of broken wires in the 50th panel on the west part of the South cable, from the top figure, at point 50 W we can find the value of 6 broken wires. Two panels (77E-78E and 76E-77E) on the north cable have a number of broken wires (307 and 119 out of 18,666 wires) that are off the charts. It is clear that locations of breaks within the main cable and the number of broken wires cannot be characterized with any specific pattern and such data cannot be accurately predicted by inspecting some selected locations along the cable. Another limiting aspect of the visual inspection is that, also in the best possible condition, the number of wires that can be “seen” is quite limited compared to the total number of wires in the cable: in fact, even when the cable is wedged open, the total number of visible wires that are exposed is limited to about 2% of the total number of wires in a cable cross section. This represents a very small sample set from which is difficult to extrapolate reliable information valid for the total wire population.



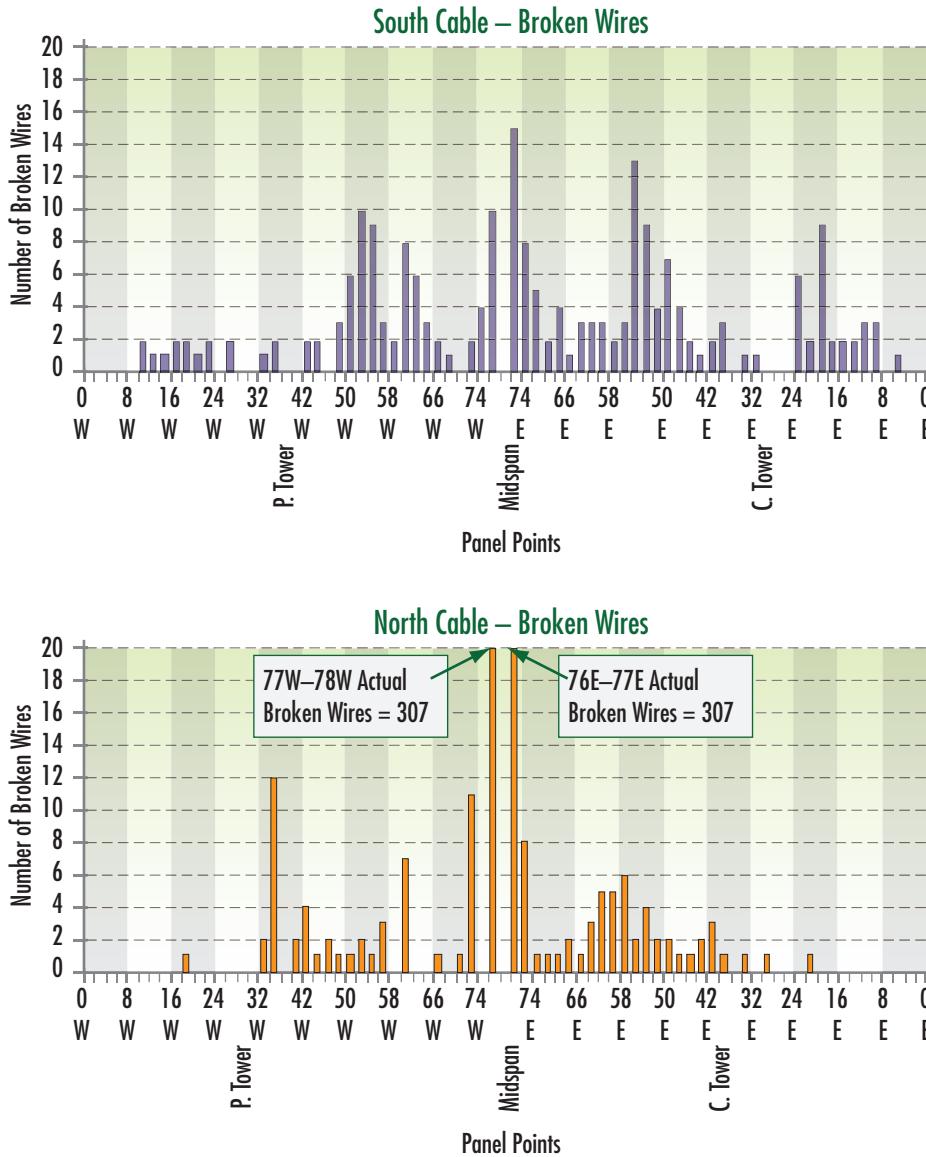

Figure 3-16: Number of broken wires along the cables of Centennial Bridge during its rehabilitation

Traditionally, during the in-depth inspection procedure, the wires are classified in categories depending on the level of wire deterioration; usually, four/five stages of wire deterioration are used in wire classification as per the visual standards, as specified in the bridge inspection manual FHWA-IP-86-26 and NCHRP 10-57 [1].

From a very comprehensive analysis of the inspections on the cable systems of the suspension bridges in the NYC metropolitan area [2], it was concluded that:

1. There is water penetration into the interior of the cable, with water pH values as low as 4;

2. It is evident that there is corrosion of the zinc coating, evidenced by the presence of zinc hydroxide (white rust), and corrosion of steel with discernible pitting and loss of wire cross section; and
3. There are broken wires inside the cables.

A listing of the bridges, from which the above information was collected, and the status of their inspection and rehabilitation of the cable system are provided in Table 3-1, obtained from the work by Bieniek and Betti [2]. In this study, more than 100 inspection reports for the main cables of the 10 suspension bridges in the New York metropolitan area were reviewed and analyzed. Most of these bridges underwent various cable inspections over their life time, with unwrapping, wedging and, in some cases, oiling of the cables.

Table 3-1: NY area bridges which were identified to have main cable corrosion

Bridge Name	Year Built	Number Of Cables	Cable Diameter	In-Depth Inspection	Cable Rehab.
1. Brooklyn	1883	4	15.75	Yes	Yes
2. Williamsburg	1903	4	18.75	Yes	Yes
3. Manhattan	1909	4	20.5	Yes	No
4. Triboro	1936	2	21	Yes	Yes
5. George Washington	1931	4	36	Yes	No
6. Throgs Neck	1961	2	21	No	No
7. Whitestone	1939	2	21	Yes	Yes
8. Bear Mountain	1924	2	22	Yes	Yes
9. Mid Hudson	1930	2	16.75	Yes	Yes
10. Verrazano	1964	4	36	Yes	No

The pattern of cable deterioration at various locations depends on many factors (stresses, geometry, exposure to sun and wind, construction details, etc.). Usually, the outer wire layers show a higher degree of degradation and a larger number of broken wires, especially in the lower portion of the cable cross section, while wire conditions improve towards inner layers. However, depending on the procedures used at the time of the bridge's construction, the deterioration pattern may be exactly reversed, and the inner wires may turn out to be in much worse conditions than those in the outer layers.

The environmental deterioration of bridge wires is a result of complex electrochemical processes, worsened by the particular geometry of the cable itself (thousands of galvanized steel wires compacted together, with a void ratio of about 20%), and their interaction with mechanical stresses [3,4]. Although atmospheric air is the most common environment, aqueous solutions, including natural water, atmospheric moisture, and rain, as well as man-made solutions, are the environments most frequently associated with degradation problems. In bridge wires, various forms of material deterioration have been associated with the word corrosion. These are surface corrosion, corrosion pitting, inter-granular and crevice corrosion, stress corrosion and corrosion fatigue. Another important process in wire degradation is represented by hydrogen embrittlement, which generally occurs in service when the part is being protected from corrosion.

The environmental deterioration of bridge wires is a result of complex electrochemical processes, worsened by the particular geometry of the cable itself, and their interaction with mechanical stresses.

Corrosion involves the interaction (reaction) between a metal or alloy and its environment. The initiation of the corrosion process and its rate of development are affected by the properties of both the metal or alloy and the environment. It follows that a measurement of the immediate environment of the cable, the changes in electro-chemical processes and the existence of corrosion products of such processes can provide valuable information in corrosion monitoring programs. For example, the measurement of pH, conductivity, dissolved oxygen, metallic and other ion concentrations, inhibitor concentrations and other indices, e.g., relative humidity, can all be correlated to the existence of ongoing corrosion. Such readings could provide an indication of the “corrosivity” of the cable interior and warn about the possible presence of corrosion in wires. On the other hand, to accurately assess the impact of corrosion on the remaining strength of a cable, one would need an NDE technique that could diagnose changes in the effective cross-sectional area and relate such changes to the reduction of the cable’s strength.

**The objective of this research study is twofold:**

1) to explore the most recent and promising NDT technologies for direct detection of the corrosion damage inside the main cables of suspension bridges and to select the most promising ones for further development and customizing for main-cable applications (Direct Sensing Method); and 2) to install a network of sensors that can monitor the external and internal environments of these cables and provide information that can be used to indirectly assess the cable’s deterioration conditions and their evolution over time (Indirect Sensing Method).

The most important environmental variables that affect the corrosion process in metals are: pH (acidity), temperature, humidity, and concentrations of solution constituents. Complex interrelationships and interactions can

exist among these variables. The combined values of variables such as pH, ion concentration, and temperature not only affect corrosion but also affect the action of each single variable and it is important to understand that the effect of one variable can be dependent on the magnitude of another.



The most important environmental variables that affect the corrosion process in metals

are: pH (acidity), temperature, humidity, and concentrations of solution constituents. Complex interrelationships and interactions can exist among these variables.

With regard to Direct Sensing Methods, it is important to consider NDT technologies that can be realistically applied in the field on an existing suspension bridge, considering the limitations imposed by working few hundred feet above the roadway, with limited or no traffic disruption, in harsh environments, with limited power sources, and so on.

In the selection of the sensors to be used as Indirect Sensing Methods, special consideration will be placed in considering the performance of such sensors in realistic conditions in which they will be subjected during service: a harsh environment, extreme reversals in cyclic histories (temperature, humidity, wind, strain, etc), large compaction forces, a lack of easy access from the exterior of the cables and the necessity of extracting clear and accurate information. The integration of indirect multimode sensing technologies and direct NDE technologies will allow bridge owners to make reasonable, cost-effective maintenance decisions.

### 3.3.3 Indirect Sensing Technologies

A variety of sensors were considered in this study, covering all the possible technological scenarios, from Fiber Optics (FO) to Linear Polarization Resistance (LPR), from Micro-Electro-Mechanical Systems (MEMS) to wireless sensors. The reason for such a broad selection is

The term “Indirect Sensing Technologies,” is used to classify all the technologies that provide measurement of quantities from which it is possible to infer a correlation between such quantities and the corrosion activity inside the cable. These quantities can be physical quantities like temperature, pH, relative humidity, etc. or quantities associated to direct mass loss of the bridge wire, e.g., corrosion rate.

that no single means of corrosion detection is either ideal or suitable for all forms of corrosion or assessment condition for a suspension bridge cable because of the peculiarity of the structural element (cable), a “bundle” of over 10,000 steel wires, subjected to strong compaction forces, with a difficult accessibility to the core, etc. Issues related to size, ruggedness, reliability, accuracy, power requirements, life span, installment, etc. must be carefully addressed in a sensor selection process. A reliable corrosion monitoring system must be an integrated system of sensors and technologies that provides

complementary (and sometimes redundant) information for an assessment of the cable conditions.

### 3.3.3.1 LPR Sensors (Analatom Inc.)

One of the sensors used in this study is the LPR sensor manufactured by Analatom Inc. This sensor, of base dimensions of  $10 \times 20$  mm and a thickness of few micrometers, is a two-electrode sensor that uses two corroding electrodes (a working one and a counter/reference one). These electrodes are made from standard shim stock of AISI 1080 steel and the inter-digitization distance between the electrode fingers determines the sensitivity of the sensors. Sensors with three different inter-digitization distances (150- $\mu\text{m}$ , 300- $\mu\text{m}$ , and 1200- $\mu\text{m}$ ) were tested in this study. The basic principle of this sensor is the following: a data acquisition unit performs a voltage sweep about the open-circuit potential of the LPR sensor, through a circuit that uses two operational amplifiers. The input voltage to the circuit is provided by the D/A converter of the micro-controller, which can provide a voltage in the 0.0 - 1.5 volts range. The output voltage is proportional to the current through the LPR sensor: from the operational amplifier circuit, this voltage is measured by the micro-controller's A/D converter, which can sense voltages in the same voltage range. The slope of the input voltage vs. output voltage curve is proportional to the polarization resistance and is calculated from a least-squares data fit on the data collected from the voltage sweep. Polarization resistance data from the sensors are then recorded and converted into corrosion rate values for the sensor through the Tafel constant of the metal. However, since the sensor is made of a material that is different from the one of the bridge wires, it is important to "tune" the corrosion rate of the sensor with the corrosion rate of the steel wires.

The calibration of the sensor reading to the corrosion rate of the bridge wire was achieved by an extensive testing program in accelerated cyclic environmental chamber in which sensors and bridge wires were corroded in the same environment: the readings from the sensors were adjusted to the mass loss that occurred in the wires. An array of NaCl solutions, ranging from mild to high corrosiveness, as well as different temperatures were used in the tests to investigate the impact of acidity, temperature and humidity on the corrosion rate. The sensors were first tested for their durability and ability to function under cyclic variation of relative humidity. A two step 4-hour cycle, consisting of a high (2 hours) and a low (2 hours) humidity step, was repeated continuously. At the start of the high humidity step, relative humidity within the chamber rose to 100% and remained constant for the rest of the phase. In the low humidity phase, the moist air inside the chamber was purged and the relative humidity dropped to approximately 30%.

New bridge wires were first stripped of the zinc coating and then bundled together in 49-wire bundles. Figure 3-17 shows one of such bundles used in this test. 4 LPR sensors were placed at various locations on the surface of and inside the bundles and, then, these bundles were placed inside a Q-Fog 1100 liter capacity Cyclic Corrosion Tester and subjected to aggressive conditions for 48 hours. The sensors showed high sensitivity to humid environments and were very successful in capturing the start of corrosion reactions (as shown in Figure 3-18). Figure 3-19 shows an LPR sensor after one week of test in aggressive conditions.



Figure 3-17: 49-Wire bundle to be placed in corrosion chamber

Additional steel wires were stripped of the zinc coating, carefully weighted, and placed in the same cyclic corrosive environment as the sensors. By integrating the sensor readings over time and comparing them with the mass loss for bridge wires corroded in identical conditions, it was possible to find the proportionality factor that can be used for tuning the corrosion rate of the sensors with those of the wires.

Figure 3-18:  
Corrosion rate reading from  
LPR sensors during accelerated  
corrosion test.

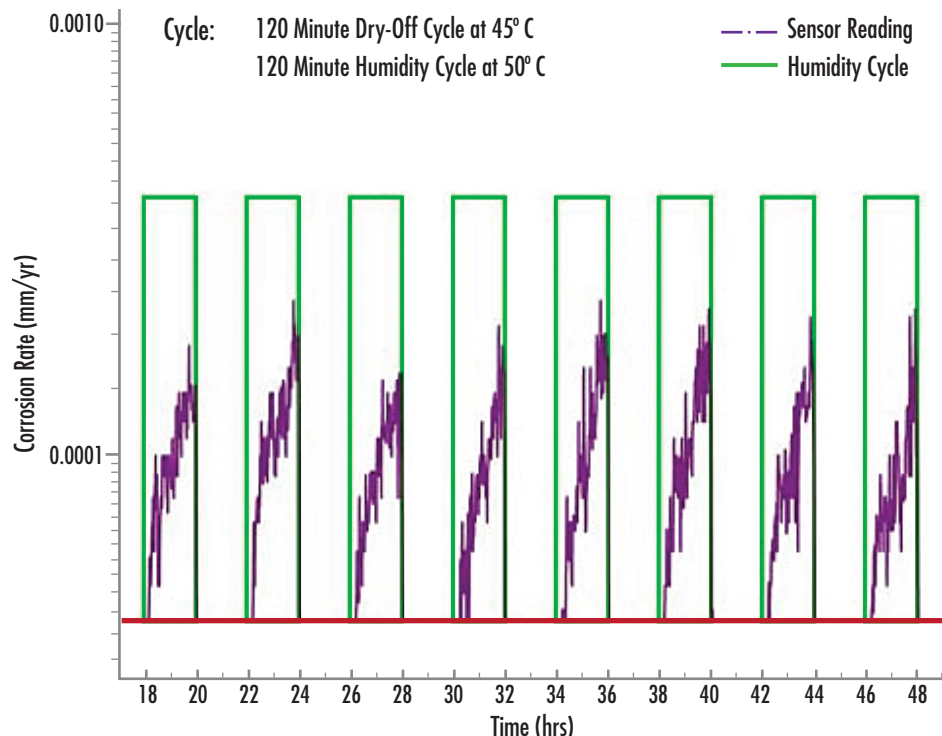



**Figure 3-19:**  
Corroded LPR sensor after one-week test

### 3.3.3.2 Coupled Multielectrode Array Sensors and Bi-metallic Sensors (CorrInstrument Inc.)

In this case, electrons are released at anodic areas and flow towards cathodic areas of the metal. Such electron flows represent the unevenness of the corrosion taking place on the metal surface. By measuring this electron flow, it is possible to estimate the corrosion rate of the metal. To do this, let us assume that the metal is divided into many small pieces: if these elements are small enough, it is reasonable to assume that some pieces will be mainly covered by anodic areas and while other elements will be mainly covered by the less corroded or not corroded areas (cathodic elements). These small pieces are electrically connected together through an instrument externally. In this way, the electrons produced at the anodic areas would flow through and be measured by the instrument and converted to non-uniform corrosion rate using Faraday's law. In the CMA sensors manufactured by CorrInstrument Inc. specifically for this study, these "small pieces of metal" are actually tiny filaments, with less than 1 mm diameter, of carbon steel, that are bundled together in a final cylindrical sensor of about 5 mm diameter (the same as a regular bridge wire). These steel filaments are separated by hard rubber matrix that serves as insulator as well as protection and each of such filaments will act either as anode or cathode. The advantage of these CMA sensors is that, being manufactured of the same material as bridge wires, they directly provide the corrosion rate of the wire, without the need for calibration of the sensor reading.



Another type of indirect sensing technology is represented by the Coupled Multielectrode Array Sensors (CMAS) provided by CorrInstrument Inc. The basic principle behind this type of sensors is that, even in most cases of general corrosion, corrosion is localized, or non-uniform. Metal surfaces in corrosive environments always present both anodic and cathodic areas.

Another type of sensors for direct measurement of the corrosivity of the environment is the Bi-metallic Sensor (BM). The basic principle of the BM sensor is the following: a sensing electrode, made of a material whose corrosion rate is of interest, is connected to a cathodic electrode (reference electrode) via an ammeter, usually a zero-resistance ammeter. The cathodic electrode is made of a metal that has a higher corrosion potential than the sensing electrode (in this case, copper). In each sensor probe (Figure 3-20), there are 8 filaments connected in pairs—4 copper, 2 carbon steel, and 2 zinc—connected so to form Cu-Fe and Cu-Zn cells. When the cathode is connected to the sensing electrode through the ammeter, the cathode raises the potential of the sensing electrode and causes the sensing electrode to corrode more. The current from the ammeter is an indication of how much the sensing electrode is corroding under the polarized condition.

Because the sensing electrode is at a potential that is higher than the normal natural corrosion potential, such current is not the corrosion current under natural conditions and is usually higher than the true corrosion current. Hence, the reading from these sensors will provide useful information about the corrosivity of the surrounding environments. If many such identical galvanic probes are used and installed at different locations in the cross-section and along the cable length, the measurements provided can give us a map of the corrosive conditions over the entire cable.

Figure 3-20:  
Schematic representation of  
Bi-metallic sensor probe

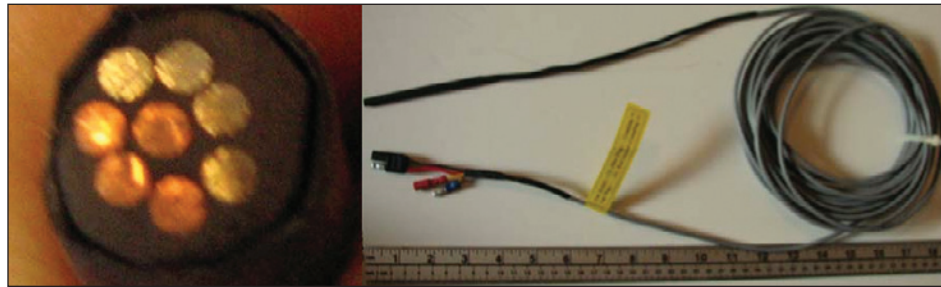

### 3.3.3.3 Temperature and Relative Humidity Sensors

To measure the distribution of variables such as temperature and relative humidity within the entire cross-section of the cable, a network of HS2000V temperature-relative humidity sensors from Precon has been developed. This particular sensor, 0.89 inch long, 0.47 inch wide and 0.365 inch tall, covers a standard temperature range of  $-30$  to  $+85^{\circ}\text{C}$  and can operate within a humidity range from 0 to 100% with an accuracy of the measurement within  $\pm 2\%$ . The geometry of such sensors, however, is such that they cannot be directly placed within the main bundle of



wires without any protection. In addition, the compaction force applied to the wires during the compaction operation would induce a pressure (about 2,000 psi) on the sensors that would cause severe damage to the integrity of the sensors. For this reason, special protection was required to protect the sensor from crashing because of the surrounding wire pressure. Stainless steel pipes, 0.5 inch in diameter and 3 inches long, covered with heat shrinking, moisture repellant tubing were used as protective covers for the sensors.

#### 3.3.3.4 Fiber Optic Sensors

In this study, FO sensors to measure temperature, pH, and relative humidity were provided by Prof. M. Ghandehari, from Polytechnic University (Brooklyn, NY). Special coatings are applied to the fiber that, by interacting with the physical variable the sensor measures, alter the light pattern inside the fiber, producing a reading. This type of sensor is particularly appealing for applications in suspension bridge cables because they would fit within the interstitial space among adjacent wires. However, because of the fragility of fiber optics, the installation of such sensors requires extreme caution. In this study, special steel piping, with a protective heat-shrinking moist-repellant tube, was applied along the length of the fiber, keeping open only the fiber's sensing part. Although great care was placed in the installation of such sensors, only few of them survived the installation process, causing a serious limitation for the future application of such sensors. Another important question that needs to be addressed in the application of such sensors to cables is represented by the durability of the coatings and their performance over time, information that is currently unavailable and need to be addressed by fiber optic manufacturers.



Another technology that shows great potential for measuring environmental parameters such as temperature, pH, chloride content, and relative humidity is represented by Fiber Optic (FO) sensors. While the use of fiber optics to measure elongations in vertical suspenders and other structural components of bridges is widespread, their applications in measuring environmental factors are relatively new.

#### 3.3.4 Direct Sensing Technologies

The common characteristic of such technologies is that they require a baseline measurement upon which any variation of the measured quantity will be compared. Such a baseline represents the condition of the cable's cross-section at a certain reference (initial) time and it is not always available. A careful calibration for different level of internal conditions must be conducted before such technologies can be accurately applied in the field.

The term "Direct Sensing Technologies" is commonly used to describe technologies that can generate direct measurements of quantities that provide an instantaneous assessment of the actual conditions inside the cable. Such quantities include magnetic flux flow, eddy current, radiations, etc.

### 3.3.4.1 Main Flux Method

Among the most promising technologies in the Direct Sensing arena, the Main Flux Method (MFM) system, presented by Tokyorope Inc. (Japan), is certainly one that shows great potential for application in suspension bridge cables. This type of technology is currently available for the condition assessment of suspenders of suspension bridges but has never been applied to a main cable of a suspension bridge. The main difficulty is represented by the scaling of the entire system to accommodate cables of large dimensions. Figure 3-21 shows the bobbin prototype, appropriately designed for this study, mounted on a cable mock-up of

20 in diameter. Currently, the size of the solenoid, its construction process, and the necessary electric power requirement make this system feasible only for laboratory applications. If successful in the laboratory testing, these issues will have to be addressed for the field implementation.

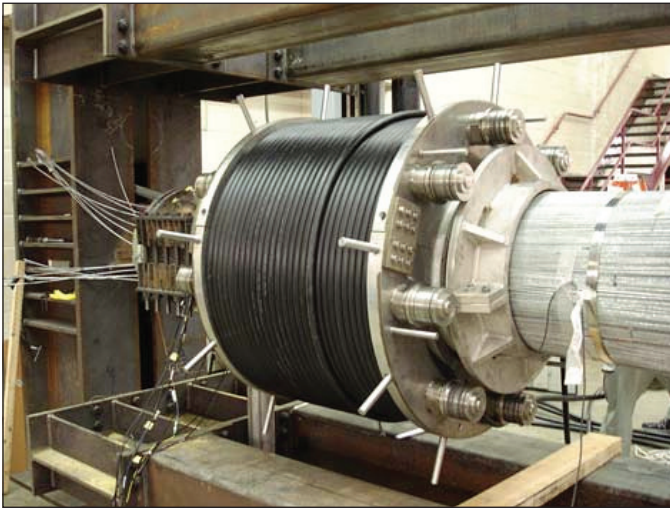

**Figure 3-21:**  
Bobbin for MFM Tokyorope system mounted on 20-inch diameter cable

variations in the magnetic flux will be representative of the variations in the cable's cross-section, providing valuable information on the internal conditions of the cable. This technology has been successfully tested on a new cable mock-up, 20-inch diameter, built in the Carleton Laboratory at Columbia University. This cable is made of 9,103 5-mm diameter steel wires and the change in the cable's cross-section was done by adding and removing up to 45 parallel wires at two separate locations along the cable length (20 ft long). The results show a linear relation between the number of wires in the cross section and the magnetic flux generated by the magnet, with the magnetic flux increasing at a slighter higher rate with respect to the number of broken wires (Figure 3-22). Considering the value of the magnetic flux for a maximum magnetic field of 55 kA/m, the magnetic flux shows a change of 0.193% for a change in cross-section of 0.165%, a change of 0.388% for a cross-section change of 0.332% and a change of 0.563% for a 0.494% change in the cable's cross-section. Tests are in progress to repeat the same type of measurements but on a cable that shows substantial corrosion.

### 3.3.4.2 Magnetostrictive Technology and Acoustic Emission

By applying a series of magnetic pulses at relatively low frequencies (in the range of few hundred kilohertz), guided elastic waves are generated in the cable, with a wave speed higher than three miles per second. When these waves hit defects, like a corrosion induced cross-section loss or wire breaks, some of the elastic waves are reflected back and detected by the sensing system. By the analysis of the nature and amplitude of the reflected waves, it is possible to locate and quantify the defect. In this study, this technology has been tested to detect corrosion in 1) single bridge wires, 2) 7 wire strands, 3) 19-wire strands, 4) 66-wire strands, 5) 127-wire strands, 6) 7 127-wire strands, 7) 19 127-wire strands and 8) on the full scale cable model.

In addition, this magnetostrictive technology has been combined with Acoustic Emission (AE) sensors. The purpose of such a combined system is to use an extended sensor network like the AE sensors that usually have a “passive” function (e.g., listening to wire breaks) in an “active” system that can be used periodically to check the status of the cable. The principal idea behind the AE-MsS is that the MsS can be used to generate an acoustic wave that propagates along the cable and its propagation characteristics can be established by analyzing the response of the AE sensors to the propagating acoustic wave. If damage appears in the cable, the propagation characteristics of the wires will change in the vicinity of the damaged area and, consequently, the characteristics of the acoustic signal propagating along the cable. In this way, an array of AE passive sensors will serve as continuous online monitoring detectors of wire brakes or other type of damage, and to evaluate the damage in combination with MsS.

An extensive series of tests was performed at Columbia University’s Carleton Laboratory with the purpose of analyzing the performance of an MsS system augmented with AE sensors in detecting corrosion induced damage in bridge wires. Various wire arrangements have been considered, ranging from progressive damage in a single wire to damage in 19 127-wire strands with progressive damage. Different damage levels have been introduced by notching wires at progressive depths and at various locations along the length. One example of such tests is presented in Figure 3-23 that refers to the case of a 127-wire strand in which an increasing number of wires has been cut.



Another interesting direct technology that shows great potential for bridge application is represented by the Magnetostrictive System (MsS) developed by Southwest Research Institute (SwRI). This technology uses the well-known property of ferromagnetic materials that causes them to change shape when subjected to a magnetic field (Magnetostriction).

**Figure3-22:**  
Relation between Magnetic Flux and number of wires in the cable cross-section for MFM technology (Tokyorope Inc.)

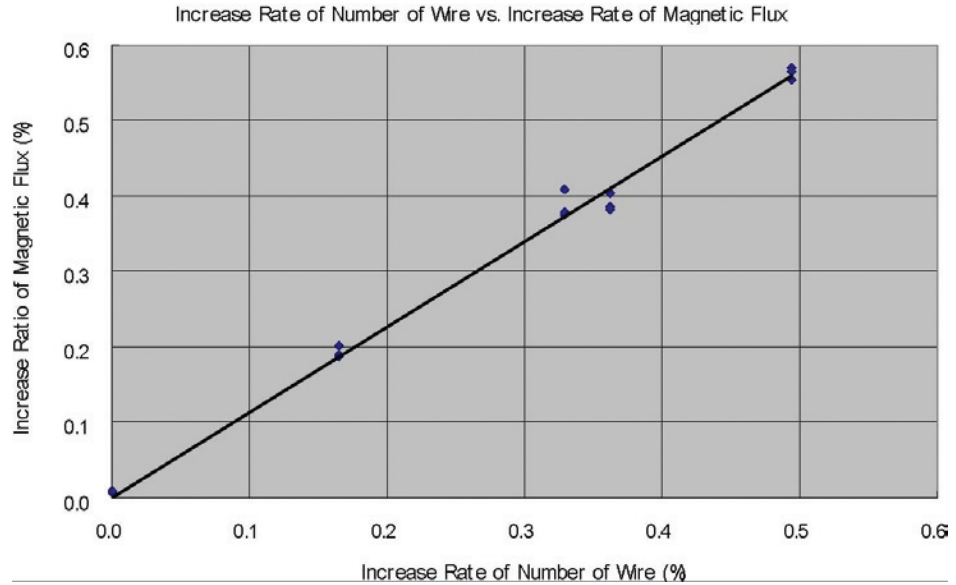

Figure 3-23 shows the maximum amplitude detected by different types of AE sensors located before (Figure 3-23(a)) and beyond (Figure 3-23(b)) the wire cut locations of a wave generated with the MsS technology. Two different types of AE sensors (R1.5I and R3I from Physical Acoustics Corporation) have been tested. It is clear that the sensors located closer to the MsS are affected in a different way by the wire cuts, as shown in Figure 3-23(a). Either the amplitude values fluctuate around the baseline, as for the R1.5I sensor or in fact increase as for the R3I sensor. For the sensors beyond the wire cut location, the drop is clear: the signal drops suddenly after the fourth wire cut. The drop in amplitude is in the range of 30% - 40% of the baseline value for the R1.5I and the R3I sensors. In terms of the cross section area of the strand, this means that the MsS-AE technique is sensitive to losses in the cross section area larger than 3%.

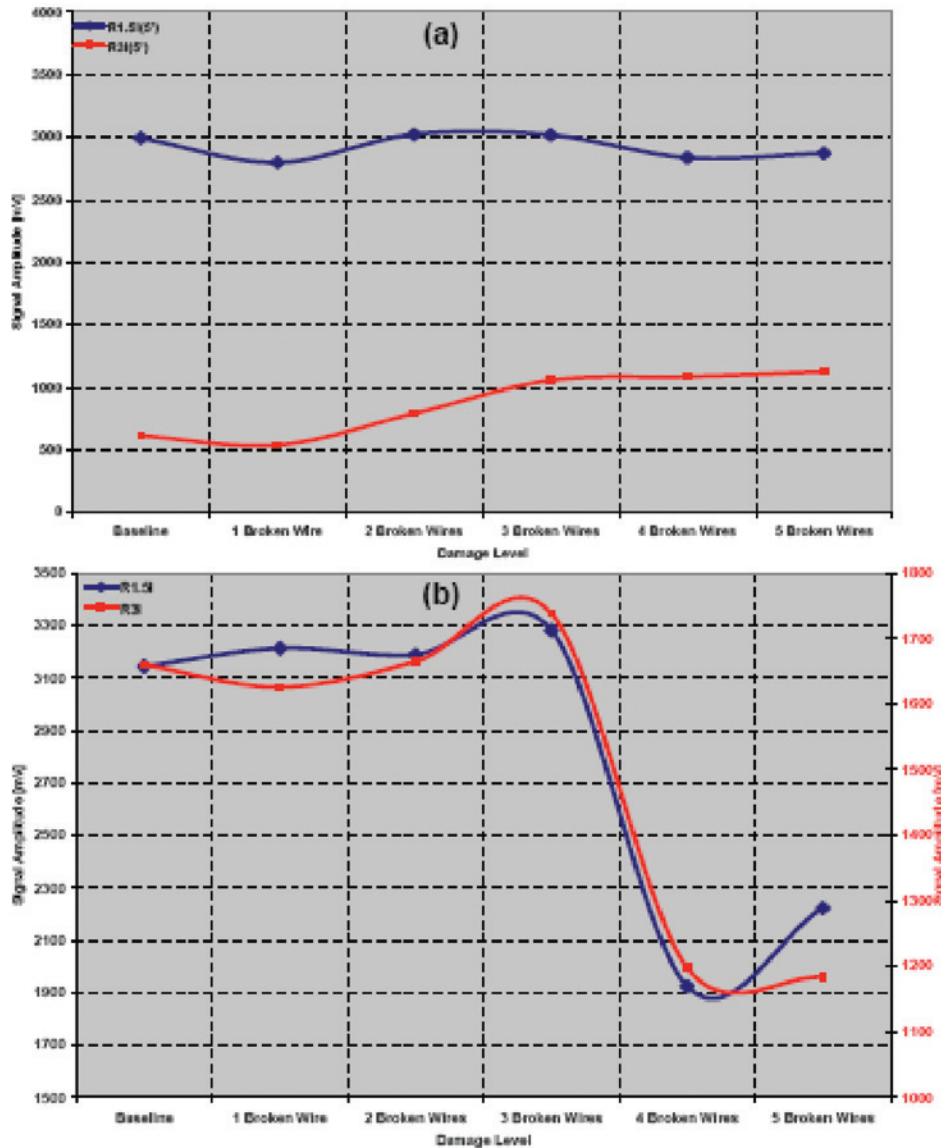

Figure 3-23: Maximum amplitude of the signals detected by the MsS-AE technique on the 127 wire strand as function of the reduction in cross section area due to 5 wires cut: (a) sensors located before the wire cut location. (b) Sensors located after the wire cut location.

### 3.3.5 Cable Mock-Up

Once the indirect and direct sensing technologies have been selected, it has been necessary to test them on a cable mock-up specimen that recreates as closely as possible the physical conditions in service in terms of size, spacing, compaction, etc.. This task has required the construction of a 1:1 scale cable mock-up in which the selected sensors/technologies have been installed and tested.

The proposed set-up consists of a cable mock, with a 20 in diameter and with a length of 20 ft, made by 73, 127-wire hexagonal strands, for a total of more than 9,000, 0.196-in diameter steel wires. The reason for building hexagonal shape strands is to optimize/minimize the void ratio inside the cable and to improve the final compaction of the cable. Of

the 73 hexagonal strands, 7 are 35 ft long and are subjected to tension load of 1,100 kips while the remaining 66 strands are 20 ft long. This cable specimen is placed in a loading frame, properly designed for this particular test, and the long strands are subjected to a load so to induce stresses up to 100 ksi (so to highlight any possible effect associated with stress-corrosion cracking). The total length of the experimental setup is over 35 ft.

An environmental chamber has been built around the cable so to subject it to harsh environmental conditions and test the performance of the selected sensors in different service conditions. This environmental chamber includes: 1) a “rain” system consisting of a set of perforated PVC pipes that can spray any type of aggressive solution, 2) a heating lamp system that can raise the temperature inside the chamber up to 125°F, and 3) an air conditioning unit to cool the entire system. The aggressive solution used in the initial test phase is made of distilled water and NaCl in an amount to have 300 ppm of Cl<sup>-</sup>.

The construction of such a cable has been a very challenging task. In fact, 1) this is the longest cable of such diameter ever built in a laboratory and subjected to some external loading, and 2) original bridge wires have been used in the construction of such a cable, so to simulate as closely as possible the real conditions and to improve the fidelity of the experiment. The use of original bridge wires has introduced a big challenge: the construction of straight strands from coiled wires. This has been resolved through a complex, time-consuming strand fabrication process. Figure 3-24 shows the cable mock-up in its final stage, together with the environmental chamber and the resisting frame.

**Figure 3-24:**  
Cable mock-up with  
environmental chamber

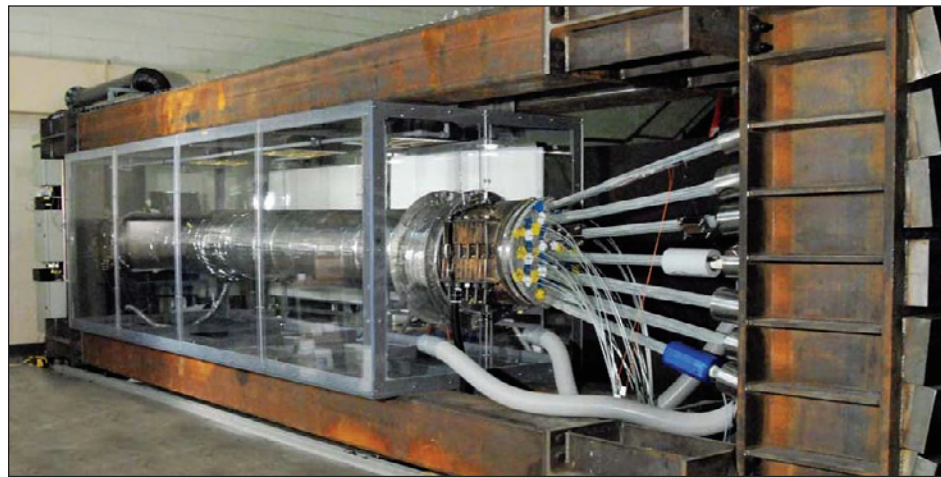

A total of 76 sensors were installed in the cross-section of the cable in the central portion of the 20 ft mock-up. Figure 3-25 provides a schematic representation of the locations where sensors were placed in the cross section. Some of the sensors, although represented as one dot, read more than just one parameter, e.g., Precon sensors read temperature and relative humidity. Sensors were placed along three diameters, inclined at a 60° angle with respect to each other. Such distribution allows us to have measurements that are distributed along the radial direction in order to have a distribution of the variations of the various parameters (e.g., temperature, humidity, etc.) over the entire cross-section.

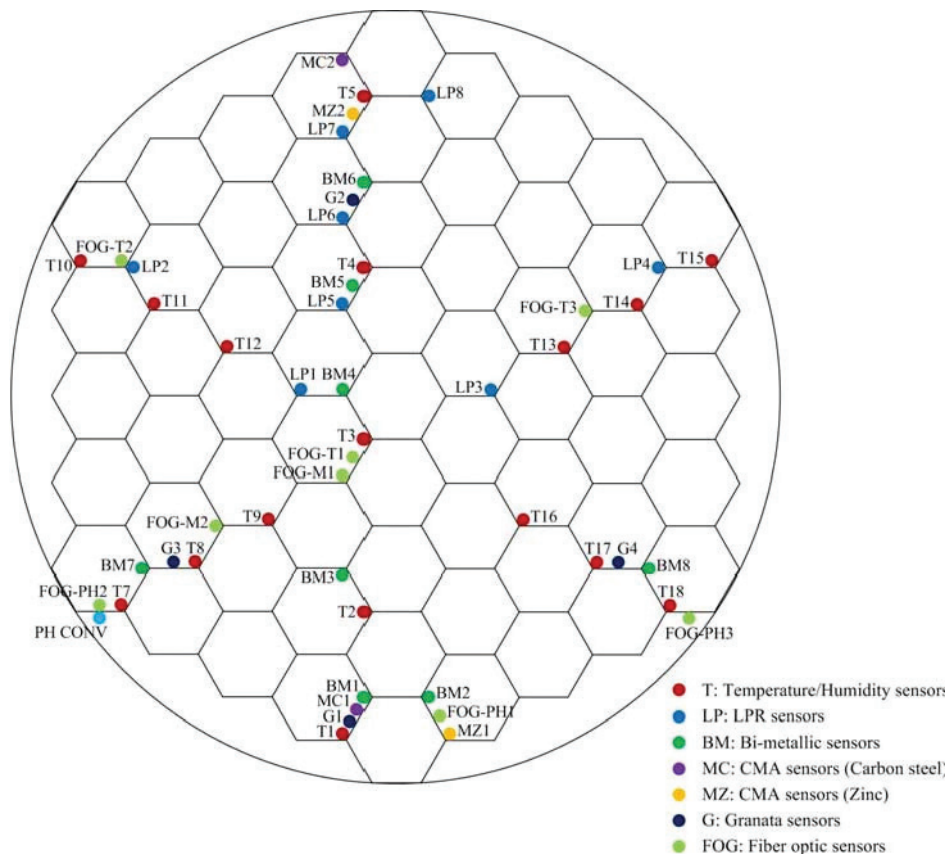

Figure 3-25:  
Sensor location in the cable's  
cross-section

Special attention had to be made in protecting the sensors from being crushed during the cable compaction. Sensors were protected using stainless steel pipes, 3 inches long and covered with heat shrinking moisture-resistant coating. The heat shrink coating was used to prevent stainless steel pipes to act as cathode and thus induce accelerating corrosion of the surrounding wires. The sensors were hard wired and the electrical wires were run out of the center of the cable at two vertical locations. After preliminary runs, it appears that almost all the sensors

survived the compaction operation, with the exception of the fiber optic one, of which 4 have not provided any reading. The final verdict will be given at the end of the testing program when the cable mock up will be opened and inspected.

### 3.3.6 Preliminary Results

At the present time, this cable mock-up has been subjected to a series of cyclic accelerated corrosion tests for over 3 months. Each cycle consists of a period of 1 hour of rain (300 ppm of  $\text{Cl}^-$ ), followed by 1 hour of heat, 1 hour of heat and air conditioning and 1 hour with only air conditioning. The measurements from all the sensors have been collected by a central data acquisition system, developed by Physical Acoustics Corporation, and correlated. As an example of the data sets collected from this testing program, Figures 3-26 and 3-27 show the readings from one of the Temperature/Humidity sensors (sensor T13 located in the upper, right quadrant of the cross-section) and from one of the Linear Polarization Resistance sensors (sensor LPR3 located in the proximity of T13) recorded at a time interval of 1 reading every 90 sec. The vertical lines indicate the duration of the 4-hour cycle.

Figure 3-26:  
Temperature and relative  
humidity measurements inside  
the cable mock-up

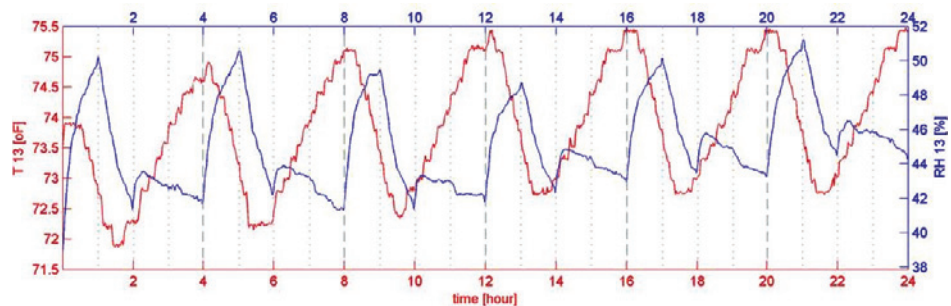

Figure 3-27:  
Corrosion rate measurements  
from LPR sensors

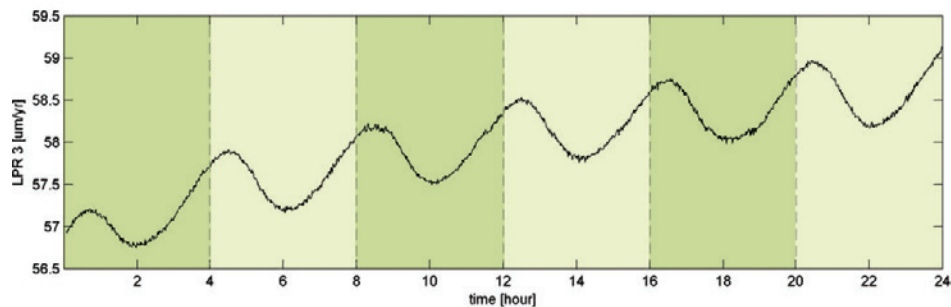



Figure 3-26 shows a temperature excursion inside the cable of about 3°F, with a mean temperature that increases over time. This is because, in each 4-hour cycle, the thermal capacity of the cable is such that the heat accumulated during the two hours of heat is not entirely dissipated during the air conditioning and rain phases. It is mainly during the rain phase that the temperature drops while, as expected, the humidity inside the cable increases. The increase of humidity during the rain phase can also be linked to the presence of water that infiltrates inside the cable through small openings of the exterior coating. The level of the relative humidity is between 40% and 50%. The general trend in a cycle is that, during the rain cycle, the inside temperature decreases while the relative humidity increases because of the presence of water inside the cable. During the first hour of the heating cycle, because of the thermal inertia of the cable, temperature continues to drop for the first half an hour, together with the relative humidity. In the second part of the cycle, the inside temperature starts increasing, causing a rapid increase in the humidity level, increase that becomes stable during the last air conditioning phase. The trend expressed by the temperature and relative humidity inside the cable at the location of sensor T13 can be correlated to the trend of the measurements from LPR3 sensor, as shown in Figure 3-27. Here the corrosion rate peaks during the rain phase: however, during this phase, temperature is cooled off and the corrosion rate decreases. This decreasing trend continues during the first hour of heat, showing a minimum at half cycle (after 2 hours from the beginning of the rain phase). However, at half cycle, while the humidity is decreasing (but still remaining above the critical threshold of 70%), the temperature tends to increase and consequently the corrosion rate; this indicates a good correlation between the temperature and the corrosion rate in a relatively humid environment.

### 3.3.7 Preliminary Field Installation

Parallel to construction of the cable mock up, a field installation of a prototype of the sensor highway system has been done on one of the main cables of the Manhattan Bridge. The goals of this early implementation are the following: 1) to look at the logistics of the installation of such a system in terms of data acquisition and transmission, wireless communication, power requirements, web accessibility, etc., and 2) to get some information on environmental conditions of the cable that will help us in defining better environmental conditions in the mock-up testing program. From the preliminary results, it appears that the sensor highway system is working and is ready to receive the final monitoring system, as it will emerge from the laboratory phase.

Parallel to construction of the cable mock up, a field installation of a prototype of the sensor highway system has been done on one of the main cables of the Manhattan Bridge.

### 3.3.8 Conclusions

In the paper, the results of an ongoing study on the development of a corrosion monitoring system for main cables of suspension bridges have been presented. Indirect and direct sensing technologies that show great potential for application in suspension bridge cables have been discussed

The results of an ongoing study on the development of a corrosion monitoring system for main cables of suspension bridges have been presented. Indirect and direct sensing technologies that show great potential for application in suspension bridge cables have been discussed and critically evaluated.

and critically evaluated. LPR sensors as well as CMAS and bi-metallic sensors have been tested using the accelerated corrosion facilities at Columbia University. Acoustic Emission technology has been successfully combined with Magnetostrictive technology in a system that can “actively” provide an assessment of the cable conditions. An interesting technology called Main Flux Method, using variations of the magnetic flux through the cross-section, has shown great accuracy in some preliminary tests conducted on a full-size (1:1 scale) cable model. A cable mock up, of 20 inch diameter, 20 ft long and loaded in tension with 1,100 kips, has been built in an environmental chamber and will serve as a testbed for such technologies: it is currently been

subjected to accelerated corrosion tests under a 4-hour rain/heat/air cycle. Seventy six sensors have been embedded in the cross-section of the cable mock-up and record environmental quantities such as temperature, humidity, pH, as well as corrosion rate. Data are currently being collected from the various sensors and will be collected for a six month testing period, at the end of which, the cable mock-up will be opened and the collected data will be critically evaluated. From the preliminary data obtained during the initial phase of the environmental test program, it appears that the system is capable of providing some meaningful data that can be used, in the near future, to predict the variation of the cable’s remaining strength over time as a function of the internal cable conditions.

### 3.3.9 Acknowledgements

The authors would like to acknowledge the support from Federal Highway Administration through the research contract DTFH61-04-C-00006, and in particular, Dr. P. Virmani (current Project Manager) and Dr. H. Ghasemi (past Project Manager). The authors would also like to express their gratitude to Dr. B Yanev of the NYC DOT for his continuous support and constructive comments. The authors would like to acknowledge Dr. Emin Aktan, from Drexel University, for his guidance in the vast world of sensors, and Mr. Ali Sohangpurwala of Concorr, for his contributions on the chemical aspects of the corrosion. A special thanks

to all the students, in particular Mr. E. Karanci and Mr. J. Xu, and lab assistants who have contributed to this project well beyond their normal responsibilities.

### 3.3.10 References

Transportation Research Board: NCHRP 10-57: *Structural Safety Evaluation Guidelines for Suspension Bridge Parallel-Wire Cables*, 2004.

R. Betti, and M.P. Bieniek: “Conditions of Suspension Bridge Cables,” Technical Report, Columbia University, 1998.

Barton, S.C., Vermaas, G.W., Duby, P.F., West, A.C., and Betti, R.: “Accelerated corrosion and embrittlement of high-strength bridge wires,” *Journal of Materials in Civil Engineering*, Vo. 12, pp. 33-38, 2000.

R. Betti, A. C. West, G. Vermaas, and Y. Cao, “Corrosion and embrittlement in high-strength wires of suspension bridge cables,” *Journal of Bridge Engineering*, vol. 10, pp. 151 - 162, 2005.

## 3.4 Integrating Baseline Structural Modeling, Structural Health Monitoring and Intelligent Transportation Systems for Condition Assessment of In-Service Bridges

*E. S. Bell<sup>6</sup> and J. D. Sipple<sup>7</sup>*

### 3.4.1. Introduction

#### 3.4.1.1 Social Need

**B**ridging the Gap, published by the American Association of State Highway and Transportation Officials (AASHTO) in July 2008, addressed the issues with our nation's aging infrastructure in response to the one year anniversary of the Interstate-35W Bridge collapse (Petroski, 2007). Five major problems of our nation's bridges are age

and deterioration, congestion, soaring construction costs, maintaining bridge safety, and the need for new bridges. Five proposed solutions for our nation's bridges are investment, research and innovation, systematic maintenance, public awareness, and financial options (AASHTO, 2008). The collapse of the I-35W Bridge was a tragedy, however it did bring the safety of our aging infrastructure into the public eye. The *2009 Report Card for America's Infrastructure* (ASCE, 2009) states that of more than 600,000 bridges in the National Bridge Inventory, 12.1% are rated as structurally deficient and 14.8% are rated as functionally obsolete. The terms structurally deficient and functionally obsolete mean "deteriorated conditions of significant bridge elements and reduced load-carrying capacity" and "function of the geometrics of the bridge not meeting the current design standards" respectively (U.S. Department of Transportation, 2009).



As the civil engineering profession continues to grow, a comprehensive condition assessment program that incorporates structural modeling, structural health monitoring (SHM), and intelligent transportation system (ITS) data becomes an economical method for making decisions related to asset management of our ever-aging infrastructure. This paper discusses detailed studies using the above three methodologies to successfully deploy and validate a model of the Rollins Road Bridge in Rollinsford, New Hampshire.

**INFRASTRUCTURE TYPE:** Highway bridges

With more than 3 trillion traveled bridge vehicle miles annually, 223 billion miles being truck traffic, traffic loading is one of the major factors in the deterioration of America's bridges. The construction boom of Interstate Highway System in the mid-1950s to mid-1970s resulted in an

<sup>6</sup> Assistant Professor, Department of Civil Engineering, University of New Hampshire, USA.

<sup>7</sup> Doctoral Student, Department of Civil and Environmental Engineering, Tufts University, USA.

unprecedented period of infrastructure construction. These 590,000 bridges are essential for the transportation of the nation's commerce as well as carrying thousands of commuters to and from work every day (AASHTO, 2008). Bridges are essential for the economy of this country but are easily overlooked since they are traveled safely day in and day out.

Prioritization of red listed bridges will be required to achieve this daunting but necessary task in an efficient fashion (NHDOT, 2008). The decision to replace or repair, and how to repair each individual bridge structure, is a common and difficult management issue for bridge owners (Farhey, 2005). For structural evaluation of bridges, various types of sensor information, such as strain distribution, vibration and natural frequencies, and deflection measurements are used to generate data that is related to the health and load carrying capacity.

Data can be collected on all types of structures in different ways, but what makes the information beneficial for decision making is how it is used to obtain value added information. Several SHM) research projects have been performed using different SHM techniques. A popular method in SHM and damage detection is the use of vibration data and modal parameters (Brownjohn, Moyo, Omenzetter, & Chakraborty, 2005). This is popular because it does not require measuring displacement, strain, and rotations, which are subject to load application and environmental effects. Such data is generally used with a finite element model of the structure to attempt to determine the bridge performance parameters by solving an inverse problem.

#### 3.4.1.2 Baseline Modeling

A structural model, verified with collected field data, can provide an objective basis on the decisions to repair or replace bridges and the importance of each action to the safety of the driving public to determine the order in which bridge repairs need to be implemented.

With the current advancements in bridge modeling programs, such as SAP2000<sup>®</sup> (Computer Structures, Inc., 2007) and GT Strudl<sup>®</sup> (GT Strudl, 2007), finite element modeling has often become part of the bridge design process. The SAP2000<sup>®</sup> Bridge Information Modeler can be used to compute influence lines and bridge response due to applied



The average bridge in the United States has an age of 43 years old and a design life of 50 years.

Therefore, the need for another large infrastructure construction project to replace the aging infrastructure is imminent.

Data can be collected on all types of structures in different ways, but what makes the information beneficial for decision making is how it is used to obtain value added information.

vehicle loads, dynamic loads, moving vehicle loads, self weight, and several other load applications including thermal loads (Computer Structures, Inc., 2007). Programs like SAP2000® and other structural analysis and design programs are used mainly as an aid in the design process in conjunction with local codes. The goal of a baseline structural model is to capture accurate structural behavior. When creating a model for structural health monitoring, it needs to be more detailed than models created for design purposes.



Bridges are typically designed according to design codes which have a goal to produce a safe bridge design in a practical time frame. Baseline structural modeling involves selecting of appropriate software where characteristics can be easily added such as the modeling of elastomeric bearing pads, carbon fiber reinforced polymers, prestressing and bridge girder geometry.

Several challenges will be presented to modelers including, but not limited to, not relying on design assumptions when creating finite element bridge models, finding the most efficient way to transmit truck load to the modeled bridge deck, and including specific elements present at the bridge in the baseline model.

The type of model used in a SHM program has different characteristics and areas of focus than a model used for design purposes. The baseline structural model must be accurate enough to capture the behavior of the bridge and be used in parameter estimation and model updating. Boundary conditions are an important and sensitive detail in modeling, such as those associated with accurately modeling elastomeric bearing pads. All loads applied to the bridge during a load test, whether they

are vehicle, temperature, or wind must be included in the baseline model. All structural properties and components of the bridge during load testing such as elastomeric bearing pads, carbon fiber reinforcement polymers, the New England Bulb Tee girder, bridge rails, and temperature effects must also be included in the baseline model. This type of model is created for the Rollins Road Bridge (RRB) in Rollinsford, New Hampshire and the model and associated special studies were verified with field data and visual observations collected during an April 2008 load test of the RRB.

### 3.4.1.3 Structural Health Monitoring Data

The goal of SHM system is to employ sensing instruments to provide information pertaining to the condition of the structure (Chang, 2003). The safety and mobility of the traveling population is dependent on the structural integrity of U.S. highway bridges. The structural health and condition of in-service bridges is usually assessed through visual inspection and nondestructive testing & evaluation (NDT/NDE) conducted on a pre-set maintenance schedule. Recent advancements in technology

have made bridge structure instrumentation very popular and relatively easy to implement (Cuelho et al., 2006 and Riad et al., 2006). It is the responsibility of the SHM division of the Federal Highway Administration (FHWA) to ensure that this collected data is then post-processed to provide beneficial information for bridge owners. FHWA envisions sensing and measurement capabilities fully integrated into the design, construction and operation of the bridge of the future (ISHMII, 2006).

Structural health monitoring data includes strains, rotation and acceleration, which are all reference independent and displacement, which is reference dependent.

#### 3.4.1.4 Intelligent Transportation Systems

Intelligent transportation data includes traffic monitoring via ramp meters and loop detector, weigh-in-motion sensors and digital imaging. Digital image correlation can be used to determine deflections, both static and dynamic.

In 1996, the U.S. Secretary of Transportation established a vision for an ITS infrastructure across the U.S. that would save time and lives and improve the American quality of life” (GAO, 2005). ITS uses communications; electronic devices, including adaptive traffic control detectors; sensors, including weigh-in-motion and strain gages; computer hardware and software to improve performance, including safety and traffic capacity of transportation systems and in some cases to impact pavement design and management. An ITS application is monitoring traffic conditions through video image procession and sensors such as loop detector, ramp meters and weigh-in motion stations (WIMS). This information can also be used for condition assessment by providing data related to the usage of the bridge, including traffic patterns, weight of trucks and digital imaging.

The goal of any ITS, as stated by the U.S. Department of Transportation is to improve “transportation safety and mobility and enhance productivity through the use of advanced communications technologies”.

#### 3.4.1.5 The Whole Is Greater Than the Sum of Its Parts

As many state and federal agencies develop a replacement and rehabilitation strategy for the aging infrastructure, this is an opportune time to provide an integrated condition assessment framework that exploits all available data to be included in the initial design and construction or rehabilitation of bridge structures. Currently the SHM and ITS data is not shared between most traffic and bridge management bureaus even though some ITS data can also be incorporated with SHM data for model updating to perform advanced condition assessment for in-service bridges. There is a significant opportunity for sharing functionality between these two systems.

In order to take full advantage of the advances in ITS technology, all aspects of transportation management must be impacted, including traffic, pavement, and bridge management. With advancements in sensor technology, several bridges are constructed with a SHM system. As these sensor systems are being deployed across the country it makes sense to integrate the collected data through structural model updating, increasing the efficiency of visual inspections, giving the bridge owners and designers unprecedented insight into what happens to the structure during its life. Also, many states, including New Hampshire, provide ITS conduit in all new construction and deck rehabilitation projects. For some projects,

fiber optic cables and power sources are also provided in the ITS conduit that could be shared by both the ITS and SHM instrumentation.

A barrier to successful model updating is assessing the structural condition in a meaningful way. There are several requirements to estimate meaningful parameters that truly reflect the physical behavior of the tested structure.

The model requires a comprehensive plan for collecting quality data using the state-of-the-art technology, a mathematical model designed for estimating parameters that are of concern to bridge designers and managers and an in-depth simulated

study that will help to understand the behavior of the model updating algorithms in presence of measurement errors and modeling errors. The analytical and experimental components of model updating are under the supervision of two usually separate groups of individuals. The cooperative collaboration of these groups each operating different sides of the same problem is the only way to ensure successful condition assessment.

Prior to developing an integrated framework for structural condition assessment, the current bridge design paradigm must be changed. In current AASHTO design practices, bridges are designed on an elemental basis. AASHTO code specifies that each structural element is to be designed for the loads it will experience during the life of the bridge. This proposed research describes development of a “baseline” bridge finite element model (FEM) and suggests certain modifications to the traditional bridge design process to take advantage of modern computing capabilities to create a refined baseline model.

The baseline FEM is an analytical model which accounts for the full system behavior of the structure, as opposed to the traditional elemental approach which envelopes loads and conditions to individually evaluate bridge structural components, thus changing the current bridge design paradigm.

This FEM will be updated throughout the life of the bridge for long-term structural health monitoring (Feng et al., 2004).

This research proposes a shift in bridge design protocol to include a baseline FEM and the intellectual post-processing of the SHM and ITS data. This shift in the bridge design paradigm will increase the initial cost of the bridge but will provide



added long-term life-cycle benefit (Bucher and Frangopol, 2006). Both parameter estimation (Santini et al., 1999 and Santini-Bell and Sanayei, 2005) and modeling (Brenner et al., 2006) will be used to develop the FEM and the model updating platform to convert the collected data into the bridge's stiffness and mass properties.

The FHWA provides significant funding for instrumentation and monitoring of bridge structures, however it provides little funding for post-processing and interpretation of the collected data. This research will open a new frontier in the area of infrastructure design and management. Combining the functionality of SHM, ITS and baseline structural modeling would help bridge the gap between initial design and in-service performance. Establishing a relationship between SHM, ITS and model updating will provide a link between bridge design, traffic and bridge management bureau at the state DOT. The combination of these departments in most state DOTs will provide a significant cost savings and more effective allocation of funding and manpower. Also, the relationships will allow researchers and practitioners to determine the future useful life of a bridge structure, based on both its structural integrity and functionality. The proposed combination will add value to any information collected through SHM and ITS alone.



This research will open a new frontier in the area of infrastructure design and management.

### 3.4.2 Rollins Road Bridge, Rollinsford, New Hampshire

#### 3.4.2.1 Background

Rollins Road Bridge (RRB) is located in Rollinsford, New Hampshire. Rollinsford is in southeastern New Hampshire about 12 miles from the Atlantic Ocean, see Figure 3-28. The bridge is not considered to be located in a coastal region, which would add considerations associated with being close to saltwater. The bridge serves as an overpass to carry Rollins Road over Main Street and an active B&M Railroad (NHDOT Bureau of Bridge Design, 1999). The weather in the area is typical of New England, with an annual snowfall of 60 inches, as recorded in Concord, NH about 35 miles west of the bridge (National Climatic Data Center). Such harsh winters mean a heavy use of deicing agents on the road surface throughout the winter months. The effects from the use of these harsh chemicals can be seen in the deck of the previous 70-year-old RRB. The deck had to be replaced/repared several times due to deterioration accelerated by use of deicing agents (Bailey & Murphy, 2008).

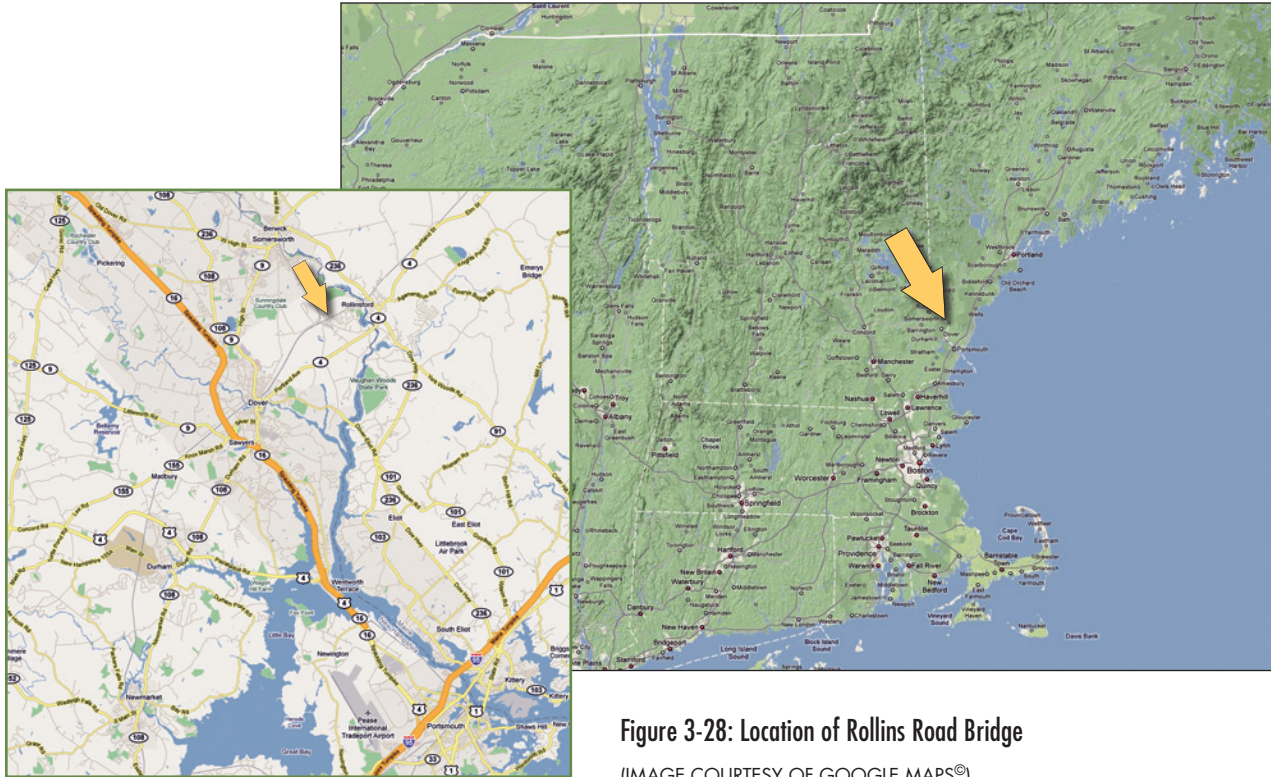

**Figure 3-28: Location of Rollins Road Bridge**

(IMAGE COURTESY OF GOOGLE MAPS®)

The original RRB was a two lane bridge, steel stringer with concrete deck, four simple spans in series making a total length of 172-feet, and built in the 1930's, see Figure 3-29. The NHDOT decided that due to corrosion of both the steel reinforcement in the concrete deck and the steel stringers, the bridge needed immediate repair or replacement (Bowman, Yost, Steffen, & Goodspeed, 2003). The last inspection report of the old RRB was done during the construction of the new bridge, shown in Table 3-2. The report notes that there were several problems with the bridge, including a rating of 3 for serious deck condition.

The NHDOT planned to remove the old Rollins Road Bridge and construct a new bridge in its place to open in the year 2000. The new Rollins Road Bridge was designed and constructed with funding from the Innovative Bridge Research and Construction (IBRC) program which is administered by the Federal Highway



Administration (FHWA). The new Rollins Road Bridge was designed and constructed with funding from the Innovative Bridge Research and Construction (IBRC) program which is administered by the Federal Highway

**Figure 3-29:  
Rollins Road Bridge prior to new bridge construction**

(BOWMAN M. M., 2002)

Administration (FHWA). The new Rollins Road Bridge, referred to from this point forward as Rollins Road Bridge, is the focus of this research project on SHM for the NHDOT.

**Table 3-2: Excerpt of the 2000 Rollins Road Bridge Inspection Report (NHDOT, 2007)**

26 October 2000 Bridge Inspection Report		
Deck	3	Serious
Superstructure	4	Poor
Substructure	6	Satisfactory

The purpose of the IBRC program is “to reduce congestion associated with bridge construction and maintenance projects, to increase productivity by lowering the life-cycle costs of bridges, to keep Americans and America’s commerce moving, and to enhance safety” (Office of Bridge Technology, 2008). Two requirements of the IBRC program are that the bridge is to be constructed with high performance and innovative materials and be instrumented. The focus of the IBRC program is using technology in the bridge to require less maintenance while keeping ease of construction a high priority in the design of the structure.

The goal of the instrumentation in RRB is to follow the progress of the new materials used in the bridge, again not for SHM. However, even though the instrumentation plan was not specifically designed for SHM, this research project was able to successfully utilize some of the sensors, including strain and temperature, in the bridge to capture the behavior of the bridge during NDT load tests.

Rollins Road Bridge, opened in December 2000 and seen in Figure 3-30, is a simply supported single span of 110-feet with a concrete beam and concrete deck superstructure. The center pier was also not included in the new bridge design for safety purposes. The bridge has a rating of 99-tons (Fu, Feng, & Dekelbab, 2003) and is in very good condition, as seen in the most recent inspection report shown in Table 3-3.



**Figure 3-30:**  
New Rollins Road Bridge, opened in 2000

Table 3-3: Excerpt from the 2007 Rollins Road Bridge Inspection Report (NHDOT, 2007)

09 July 2007 Bridge Inspection Report		
Deck	9	Excellent
Superstructure	9	Excellent
Substructure	9	Excellent

### 3.4.2.2 Instrumentation Plan

As part of the IBRC, RRB was instrumented in order to capture the behavior of the Carbon Fiber Reinforced Polymer) and the bridge deck which contained an innovative material. All of the sensors in the deck are oriented in the lateral direction, perpendicular to the flow of traffic. This was done in order to understand the behavior of the deck as it bends over the girder when a load is applied. The only gauges oriented in the longitudinal direction, with the flow of traffic, were gauges in the precast, pre-stressed, high performance concrete NEBT girders. The purpose of these gauges was for researchers from the University of Nebraska at Lincoln to quantify the loss of pre-stressing in the high performance concrete girders. These longitudinally oriented gauges proved to be most beneficial for the SHM program since they capture the global bending behavior of the bridge. The instrumentation plan was not designed for SHM, however full advantage was taken of the gauges for research in SHM.

The fiber optic concrete strain sensors used in this project are Fabry-Perot strain gauges for embedment in concrete (EFO). The actual Fabry-Perot strain sensor was mounted inside a stainless steel envelope with two end flanges to ensure durability and protection of the sensor for long term monitoring projects, such as RRB. The fiber optic sensors were also small in size, lightweight, non-conductive, resistant to corrosion, and immune to electromagnetic noise and radio frequencies eliminating need for shielding and lightning protection (Choquet, Juneau, & Bessette, 2000). In RRB, all of these strain gauges were concentrated between girders 3 and 4, near the longitudinal midspan. Temperature sensors were also installed in the deck to obtain internal concrete temperatures.

The purpose of the girder sensors was originally to instrument and observe the prestress loss in the high performance concrete girders. The *NCHRP Report 496* (Tadros & Al-Omaishi, 2003), which included the RRB was used to create the baseline model. Girders 3, 4, and 5 have strain sensors installed at the longitudinal midspan of the bridge and at three different depths throughout the girder. These sensors were placed after tendon prestressing but before concrete placement. Figure 3-31 shows

which gauges were used for analysis in this project. Only four of the original nine girder gauges were active for all load test performed on RRB and therefore included in this research.

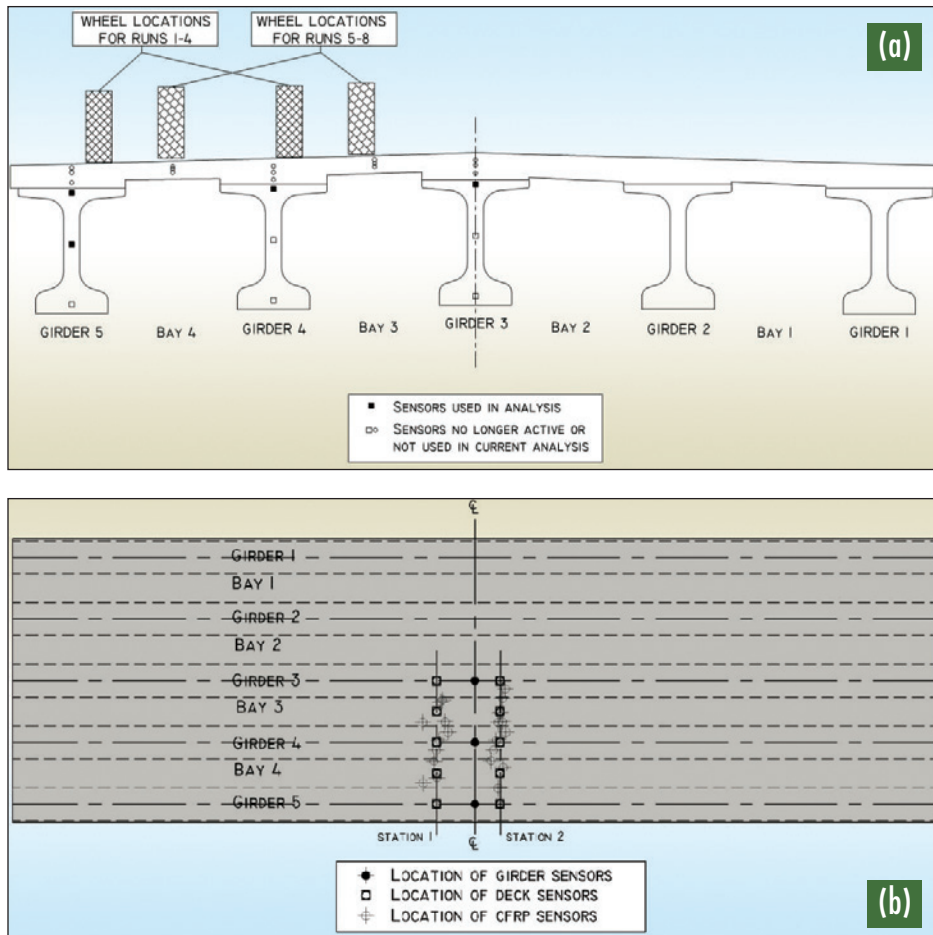

Figure 3-31: Graphic of sensors used in Rollins Road Bridge analysis; (a) shows the sensors in section view and (b) shows the sensors in plan view

The data management instrument (DMI) was located on-site and was in good working condition. The DMI is a 32-channel fiber optic data acquisition system provided by FISO Technologies, Inc. This particular DMI model has the ability to record continuous data or be calibrated for a controlled static load test. Since the start of the research project, continuous temperature and strain data has been downloaded from the bridge for use by future researchers to investigate the long term thermal performance of the CFRP and concrete deck through trends and examining material properties. For the continuous, long term temperature and strain data the DMI was configured to take 60 readings over the period of an hour and average those values to produce one data point for that hour. The DMI was also attached to a modem, allowing researchers to remotely call the bridge to download data or see current conditions.

### 3.4.2.3 Displacement Measurement Using Digital Imaging and Surveying Equipment

A digital camera was tripod mounted 30.5 m from the bridge along the midspan line with the optical axis approximately perpendicular to the span. To stabilize the setup during the test, the tripod was set on concrete blocks and the camera was controlled remotely from a laptop computer. The effective focal length of the telephoto zoom lens was 665 mm, providing a field of view of 1.73 m x 1.32 m at a resolution of 2816 x 2112 pixels. From the imaging geometry the vertical pixel resolution was measured to be 0.61 mm using a calibration image. A high contrast target consisting of a pattern of five 50.8 mm diameter black objects on a white background was placed at mid-span (Gamache, 1995). The camera placement is shown in Figure 3-32.



Figure 3-32:  
Digital Camera Set up for Digital Image Correlation at Rollins Road Bridge

The Rollins Road Bridge has bolts installed to the underside of the girder and deck for purposes of taking displacement measurements. When planning the load test, researchers determined when the center of mass of the truck would be closest to the midspan of the bridge, therefore having the largest deflections on the single span structure. Displacement measurements were taken at five locations at the midspan of the bridge, on girder 5, bay 4, girder 4, bay 3, and girder 3. The NHDOT Survey Crew used a digital leveling rod to take the measurements. A NHDOT bucket truck was used to get a survey crew member up to the underside of the bridge, as

seen in Figure 3-33. Displacement readings are typically not used in SHM since they are highly reference dependent measurements. Displacement data, collected from both digital image correlation and surveying was not used in this research due to anomalies caused by environmental effects. Improvements on this procedure are part of the future work associated with the research program at the University of New Hampshire (Gamache and Santini-Bell, 2009 and Sipple and Santini-Bell, 2009).



**Figure 3-33:**  
Photo of load test while survey crew takes displacement reading

### 3.4.2.4 Field Testing

The load test for the RRB was conducted on 18 April 2008. The purpose of this load test was to collect data in a similar fashion to the previous load tests, while also collected data to be used for SHM. Rollinsford Police Department was used for traffic control on the bridge during the load test. No traffic was allowed to pass while strain readings were being taken, and traffic was allowed to pass when the load truck was being moved. Three zero-load readings were also taken during the duration of the load test, which proved to be crucial in relating measured response to the monitoring model.

#### 3.4.2.4.1 Truck Specifications

This load test, like the previous two load tests was done in conjunction with the NHDOT. A two axle NHDOT Sand Truck, as seen in Figure 3-34 and Figure 3-35 was used for load application to the bridge. The wheel weights of the truck were taken in similar fashion to the previous load tests by the New Hampshire State Police Mobile Weigh Station, a Haenni Scales, model #WL 101 (Haenni, 2008), have a variance of less than 1% and are tested and certified by the NH State Police., as seen in Figure 3-35. The gross weight of the truck was 37.4-kips (18.69-tons).



**Figure 3-34:**  
NHDOT sand truck as load application during April 2008 load test



**Figure 3-35:**  
Trooper Huddleston (NH State Police) taking NHDOT wheel load measurements

The dimensions for the truck were 14-foot 9-inches between the center of the front and rear wheel. The rear dual had a thickness of 1-foot 8-and-1/2-inches. The rear axle, center of dual to center of dual, length was 6-feet 2-inches. The front wheel had a thickness of 8-inches and the length of the front axle from center of wheel to center of wheel was 7-feet.

#### 3.4.2.4.2 Testing Plan

The truck ran in the north-west direction and south-east direction a total of eight times, four in each direction. Two separate marking groups were laid out on the bridge. One group had a wheel directly on the girder and the other had the wheels

straddling over a girder. Each group of markings was traveled two times per direction, two directions, equaling four times per marking group, two marking groups, a grand total of eight passes. Initial measurements for the markings were done using an estimated truck size, and the actual truck that was used for the load test was similar to those estimations. In runs one through four, the trucks wheels were on girders five and four. For runs five through eight, the trucks wheels straddled girder 4.

#### 3.4.2.5 Structural Modeling

The initial modeling protocol focused on including specific elements and environmental impacts. The goal was to create a usable model for the NHDOT SHM program. The structural model was created using the BrIM™ (Bridge Modeler) in SAP2000®.

Once the design based model was created using the BrIM™ to a degree of satisfaction, the bridge modeler was turned off, allowing researchers take full control of element properties included in the model. The use of the BrIM™ takes full advantage of all the research done by Computer & Structures, Inc. (CSI) for the creation of the base bridge model and then allows researchers to build upon that model to reach the final goal. Structural components included in this baseline model were prestressing tendons in the girder, CFRP reinforcement in the deck, the bridge rail, and boundary conditions modeled as springs with prescribed stiffness. This model was then verified using the collected field data, which meant that the model needed to be coordinated with the truck loading locations and environmental impacts as well.



Figure 3-36 shows the final model created for the Rollins Road Bridge, which includes the parapet link to the bridge deck and spring supports for boundary conditions.

#### 3.4.2.6 Prestressing Tendons

The SAP2000® BrIM™ contains preloaded concrete girder sections. Those sections can be used or modified depending on the properties of the girder located at the bridge. This was one big benefit to using SAP2000®, and it contains all of these different options which makes model easy for all bridges, not only RRB. The preloaded AASHTO PCI bulb tee included in the BrIM™ was modified to match that of the NEBT used at the RRB.

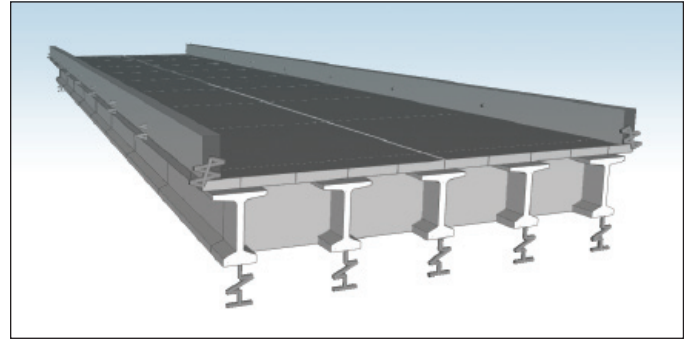

Figure 3-36: Final model of Rollins Road Bridge in SAP2000®

Prestressing tendons were included in the RRB model to accurately capture the bending behavior of the girders. SAP2000® has the ability to add strand patterns. The two deflection point pattern used at RRB was one of the many options in the BrIM™. The design plans were used for all of the stressing, arrangement, and steel specification information. Losses were calculated using the AASHTO Bridge Code (AASHTO, 2004). The use of these values was validated through NCHRP Report 496 which examined and documented the actual losses at RRB and compared them with losses calculations using AASHTO (Tadros & Al-Omaishi, 2003). During fabrication, special care was taken to ensure that the strand pattern was accurately laid out, as prescribed in the plans, and researchers were present at time of prestressing and pouring of the precast girders to ensure compliance. Due to the research driven nature of this project, there was extra control in all aspects of construction, which allows researchers a high level of confidence that the bridge was constructed as designed and specified.

#### 3.4.2.7 Carbon Fiber Reinforced Polymer in the Deck

The deck was modeled using design plans for RRB and measured distances (Bowman M. M., 2002). No as-built drawings were available for this bridge deck, so between Bowman's (2002) data and the design plans, researchers felt fairly confident in the dimensioning for the deck. CFRP reinforcement in the deck was included once the bridge modeler was turned off and the type of finite elements used for the bridge deck was changed from shell elements to layered shell elements. The deck of RRB contains two layers of CFRP reinforcement, one above and one below the centroid of the deck section.

In order to correctly model the CFRP material, the material specifications, modulus of elasticity, and density were obtained from previous work (Bowman M. M., 2002 and Trunfio, 2001). The thickness of the CFRP throughout the entire width of the deck was maintained to keep the correct moment of inertia in the transformed section and having the ability to model it in SAP2000®. Since the layered shell material was throughout the entire thickness, not just present every 6-inches, the modulus of elasticity was transformed to capture the same behavior as it is placed in the bridge. The modification was achieved by taking a ratio between the actual area of CFRP in the cross section and the modeled area and then reducing the modulus of elasticity for the layer. A graphical representation of the steps list above can be seen in Figure 3-37.

**Figure 3-37:**  
Graphical representation  
of how CFRP is modeled as  
layered shell element

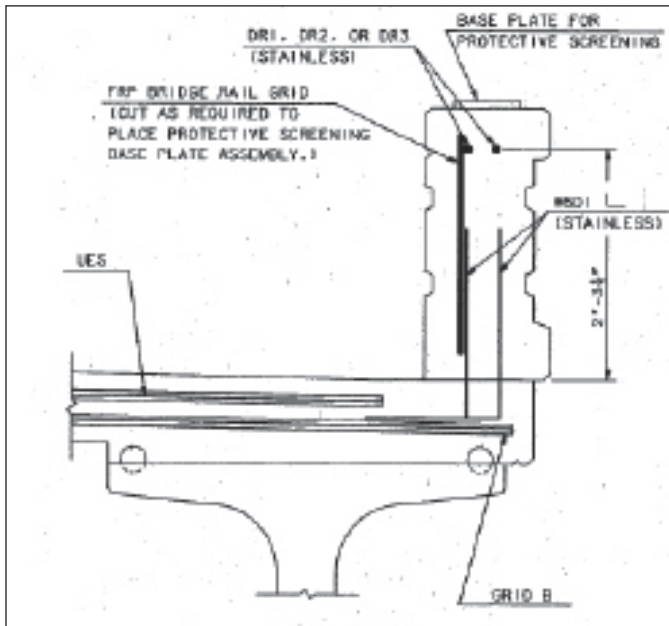
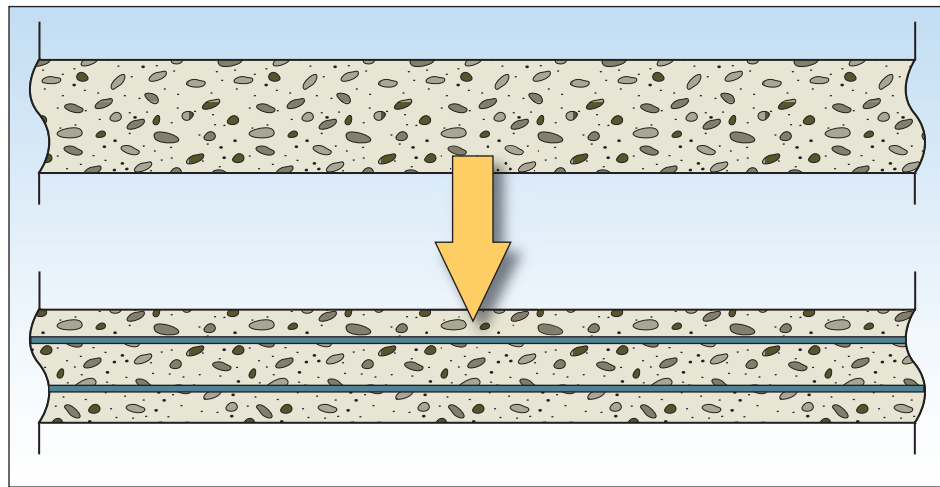

### 3.4.2.8 Bridge Rail

The bridge rail at Rollins Road Bridge is a cast-in-place concrete rail. The use of concrete bridge rails is replacing the conventional aluminum/steel guardrail for NHDOT bridges. The rail will be modeled as a frame element and connected to the bridge deck through links since, as seen in Figure 3-38, it is connected to the bridge deck using stainless steel reinforcement.

**Figure 3-38:**  
Section view of bridge rail connection to bridge deck  
(NHDOT BUREAU OF BRIDGE DESIGN, 1999)

### 3.4.2.9 Elastomeric Bearing Pads

Steel reinforced elastomeric bearing pads support the Rollins Road Bridge on the abutments which transfer all loads into the ground. The bearing pads have three different possible directions of motion, as seen in Figure 3-39, caused by axial load, shear forces, and rotation.

Visual inspection showed no cracking or deterioration in the deck or girders. Research has been conducted beyond the initial research performed by AASHTO on both the axial and rotational stiffness of steel reinforced elastomeric bearing pads in order to develop bearing pad stiffness (Stanton, Roeder, Mackenzie-Helnwein, White, Kuester, & Craig, 2008). This research and physical testing, has resulted in two equations, seen in Equation 1, that can be used to calculate axial and rotational stiffness for one layer of the elastomer. Combining the stiffness values of each layer of elastomer and steel together results in an overall stiffness for the bearing pad (Stanton, Roeder, & Mackenzie-Helnwein, 2004).

Equation 1. Axial and rotational stiffness of one layer of elastomer (Stanton, Roeder, & Mackenzie-Helnwein, 2004)

$$K_a = \frac{P}{\Delta_a} = \frac{EA(A_a + B_a S^2)}{t}$$

$$K_r = \frac{M}{\theta_r} = \frac{EI}{t} (A_r + B_r S^2)$$

A total of ten, 16-inch diameter, steel reinforced elastomeric bearing pads are installed at RRB, one at each end of each girder. The bearing pads allow slight vertical compression while allowing the beam to rotate. Modeling spring boundary conditions, via links, in SAP2000® is also fairly simple. The BrIM™ allows for several different types of boundary conditions to be used, from traditional fixed or pinned connections, to user defined links. When links are used, the user is allowed to specify stiffness in all directions. Links are used because they can be updated in

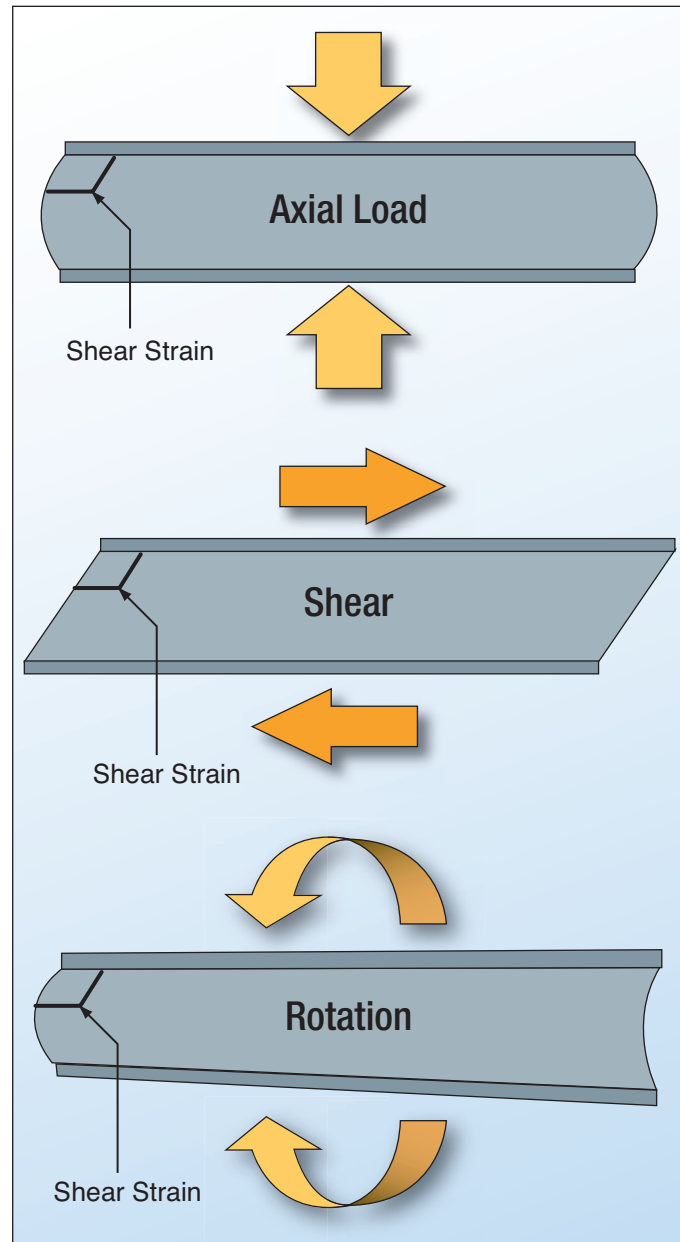

Figure 3-39: Deformations of a laminated elastomeric bearing pad

(STANTON, ROEDER, MACKENZIE-HELNWEIN, WHITE, KUESTER, & CRAIG, 2008)

the model updating process and more accurately capture the behavior of the actual bearing as opposed to a pinned or fixed condition. In the U2 directions (translation parallel to the abutment) a stiffness of 1.000E+09 is used to show fixity in those directions and in the R1 and R3 directions (rotation about a line normal to the abutment and about a vertical line) a stiffness of 1.000E-09 is used when rotational stiffness is not included. These values are specified instead of using the option to be fixed or free in the SAP2000® program window because using those options caused numerical instability in the analysis. Using values that accurately represent fixed and free did not cause the numerical instability but essentially gave the same response.

Stanton et al. (2008) has equations to calculate axial and rotational stiffness of the elastomeric bearing pads, however does not provide equations for the calculation of horizontal stiffness caused by shear effects. That value estimated using the collected field data from the April 2008 Load Test.

#### 3.4.2.10 Load Application

Typical load application is achieved by applying a load to a node in the model.

Typical load application is achieved by applying a load to a node in the model. The BrIM™ has a pre-determined pattern for creating joint locations in the bridge model, not necessarily where the truck will be. A solution was to place nodes where there was a point of load application. That led to confusing creation of shell elements to get a solid deck. There could be an infinite number of different locations for load application during a load test that may not necessarily already be a joint. Typical load application is done by a truck, which in reality are applying the wheel loads over an area.

If a finite element mesh was created and the area loads were applied to this separate mesh, resultant forces could be calculated at points of actual node locations on the bridge. A fine mesh, using 3-inch spacing, was created to obtain the force resultants. Once this mesh was created, it could be moved to any place on the bridge to find resultant forces. This universal method proved to be useful during the analysis portion of this research project, allowing loads to be applied in different locations on the bridge depending on the specific load case. Once the mesh was moved to the area of load application, the equivalent area loads were applied to the mesh model, and the two existing nodes on the deck were selected as boundary conditions in the mesh model. This was done for all areas of load application and the mesh model was run. The resulting reaction forces from the mesh model were then applied to the deck nodes, as seen in Figure 3-40.

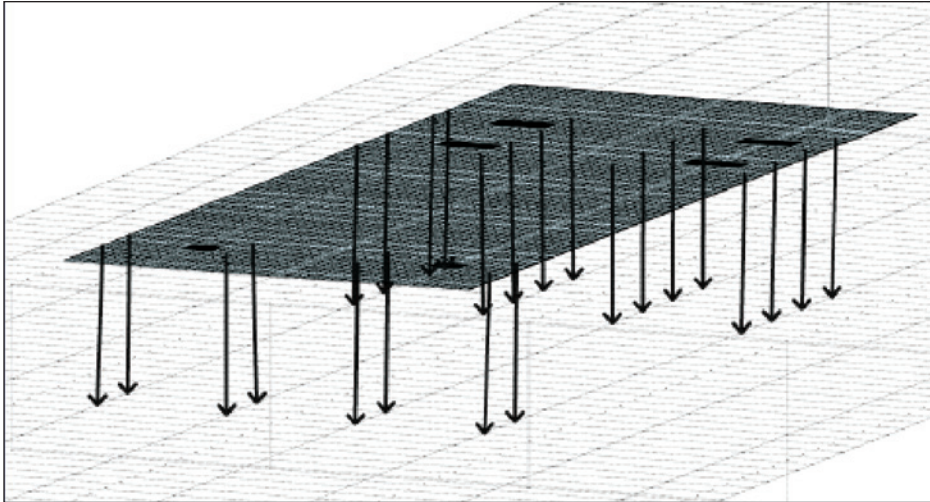

Figure 3-40:  
Truck load mesh to bridge deck  
graphic

The use of force resultants can be done because the focus of the load tests was to look at the overall effect on the bridge. The sensors used in the analysis were in the girders, so local effects from the truck wheels were not of concern. It also takes full advantage of using the BrIM™, while still being universal enough to apply loads to existing nodes at any location on the bridge.

### 3.4.3 Verification Results

Table 3-4 shows the five different support conditions (SC) used in second manual model updating analysis. The vertical stiffness values and horizontal are modified in the first four cases, and the fifth case shows that modification of the horizontal stiffness value must be done in order to get the change in model strain to match the measured change in strain. The error of  $\pm 0.40$ -microstrain shown in the error bars for the measured strain corresponds to the accuracy of the gauges as set when installed. Support Condition 1 uses the vertical and rotational stiffness value as calculated by Equation 1. Figure 3-41 plots the response of the bridge at a single location, as indicated by the dot in the figure in the upper right corner of the figure, for four truck loadings. The “empirically corrected measured” data is the collected strain data from the RRB test in April 2008 with a linear correction for environmental effects (Sipple and Santini-Bell, 2009). This correction uses the three zero-load points recorded during the April 2008 test to approximate the environmental effects, including temperature, which ranged over 20 degrees Fahrenheit during the lead testing.

Table 3-4: Manual model updating cases and corresponding bearing pad stiffness values for second analysis

	Vertical Stiffness (kips/in)	Rotational Stiffness (kips/rad)	Horizontal Stiffness (kips/in)
Support Condition 1	46833	224651.5	fixed
Support Condition 2	46833	free	fixed
Support Condition 3	fixed	free	fixed
Support Condition 4	46833	fixed	fixed
Support Condition 5	46833	224651.5	10000

Figure 3-41:  
Manual model updating using  
girder 3 top strain sensors

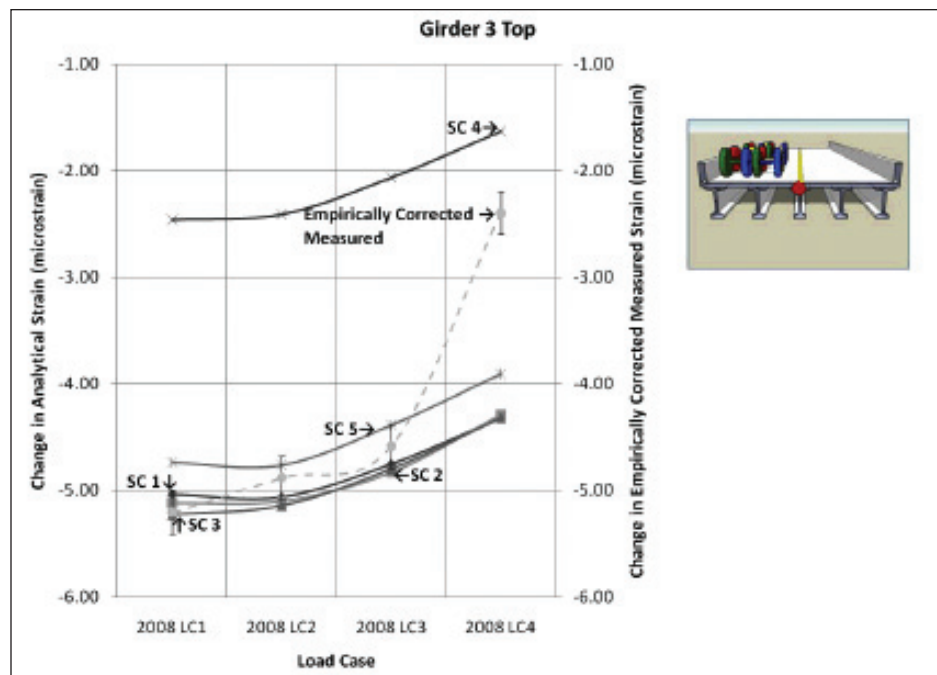

### 3.4.3.1 Conclusions on Manual Parameter Estimating Results

The results from the manual parameter estimation show that the change in measured structural response could match the change in modeled response by modifying the horizontal stiffness of the elastomeric bearing pad. The final bearing pad stiffness ended up being 46,833-kip/in in the axial direction ( $k_a$ ), 10,000-kip/in in the horizontal direction ( $k_h$ ), and 224,651-kips/rad for rotation ( $k_r$ ). Figure 3-42 and Figure 3-43 show a quantification of the bearing pad stiffness values used as compared to a roller, pinned, and fixed connection. This is only to show the effects of the spring on an example 40-foot beam with a 10-kip point load, not the actual bridge configuration. The axial and horizontal stiffness remained as calculated since there was nothing to suggest otherwise, and the horizontal direction was modified to get the structural response to match. According to Stanton et al. (2008), there are no standard calculations for the horizontal stiffness value.

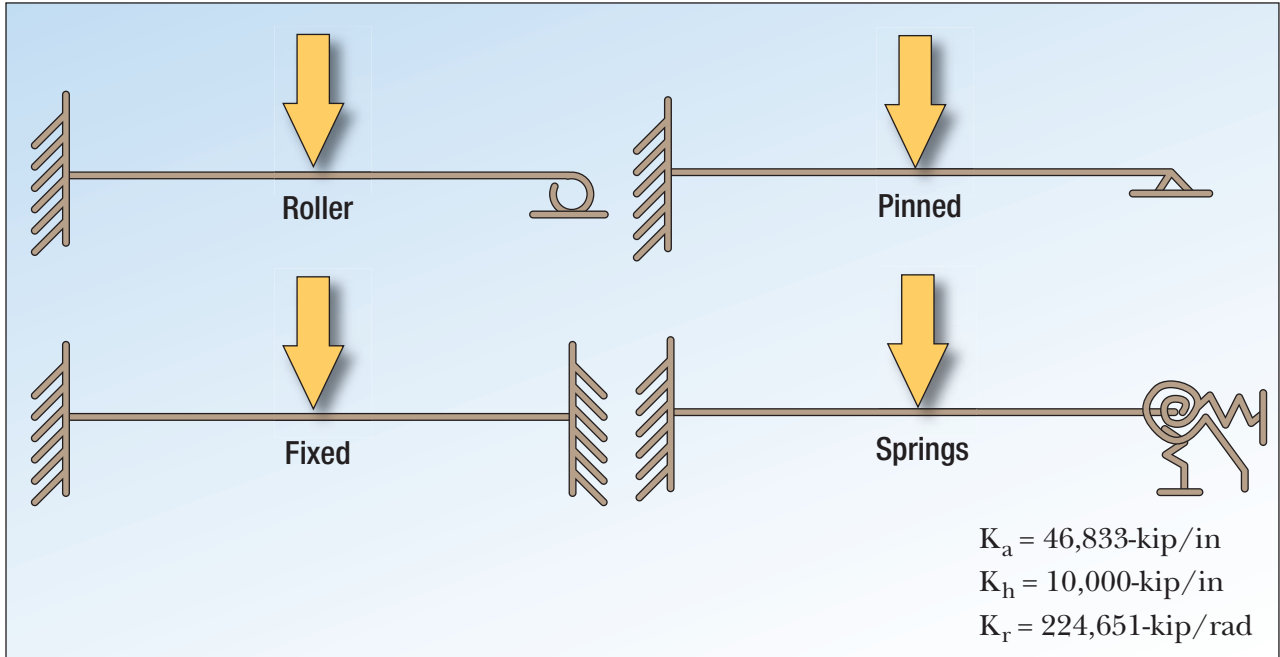

Figure 3-42: Quantification of bearing pad stiffness examples

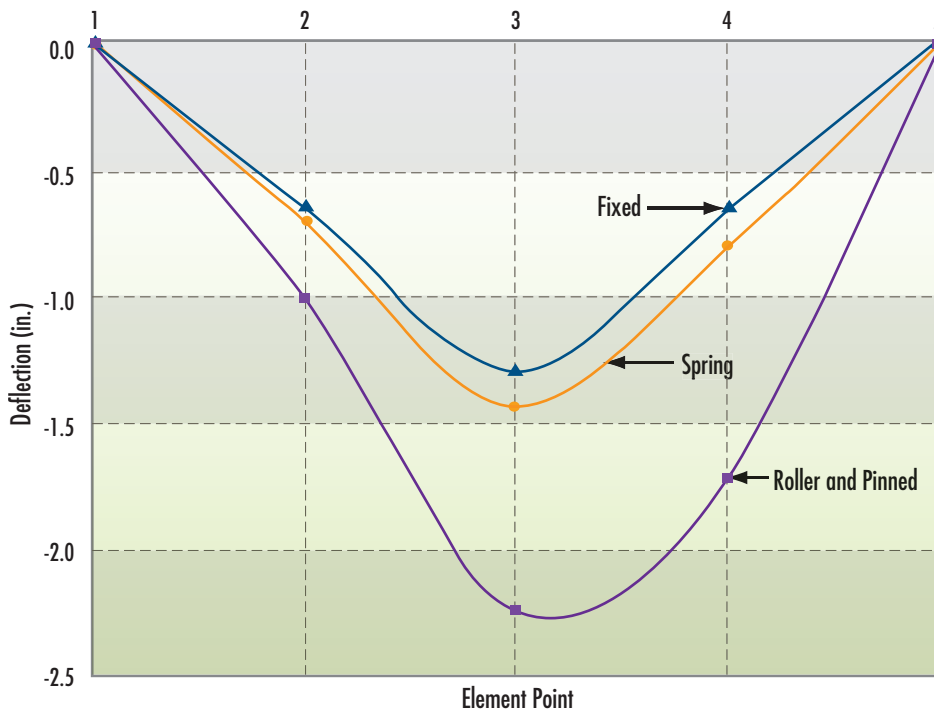

Figure 3-43: Quantification of bearing pad stiffness results

### 3.4.3.2 Analysis of Removing Specific Structural Elements

The bearing pad stiffness obtained from the above analysis, support configuration 5 now benchmark, will be kept constant in the next analysis of modeled response.

Table 3-5 shows the four cases that will be used to show the effect of specific parameters in the model. Structural parameters such as CFRP, prestressing, and bridge rail will be removed from the SAP2000® model, and the response is seen in Figure 3-44.

Table 3-5: Manual model updating cases and corresponding bearing pad stiffness values for third analysis

	Vertical Stiffness (kips/in)	Rotational Stiffness (kips/rad)	Horizontal Stiffness (kips/in)
Benchmark	46833	224651.5	10000
No CFRP	46833	224651.5	10000
No Prestress	46833	224651.5	10000
No Bridge Rail	46833	224651.5	10000

Figure 3-44: Manual model updating using girder 3 top strain sensor

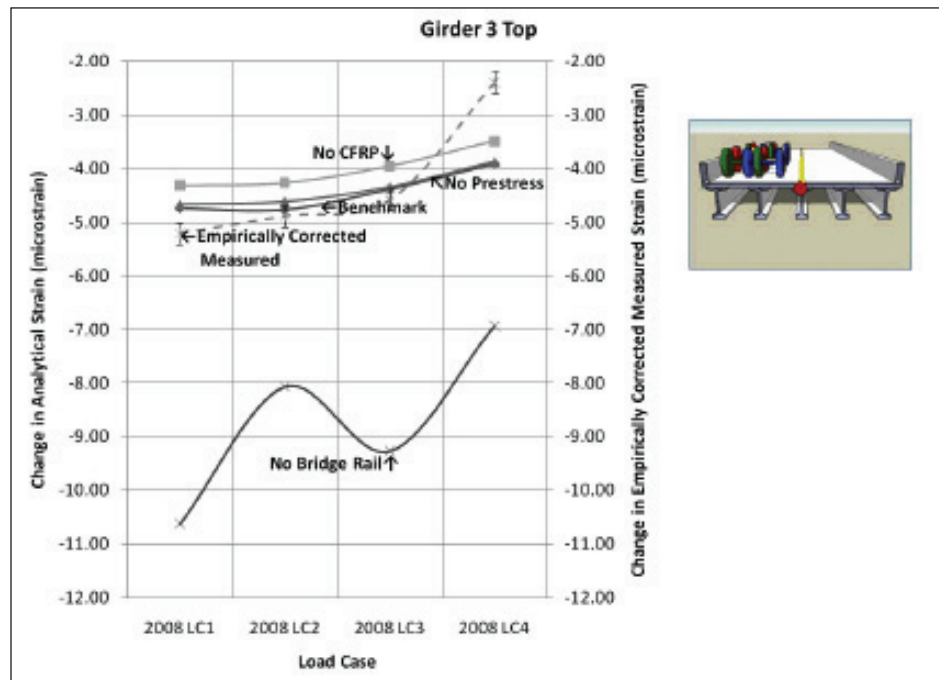



These results show that excluding the bridge rail from the model had significant effects on the change in measured response of the bridge model. Removing prestress and/or CFRP had a smaller effect in change of strain but it must also be remembered that this is a change in strain, so the benchmark model for the base also has no CFRP or prestress which explains why the values appear to be similar.

### 3.4.4 Conclusions

The stiffness of the bearing pads was updated solely for the reason of experimentally determining the horizontal stiffness of the elastomeric reinforced bearing pad, the one stiffness value not given through experimentally verified, industry-accepted equations. The effects of including the bridge rail can be seen when that element is removed. Another option to deal with the bridge rail would be to break up the element that models the bridge so it is not modeled as a continuous bridge rail, which would more accurately reflect how it is cast on the bridge. Also, the information in previous NCHRP reports, specifically relating to bearing pad stiffness value and prestressing losses in the concrete girders was invaluable in the creation of the baseline model. Even though these reports were not created with the goal of condition assessment, the information that contain can be used in a condition assessment program for a large sub-section of highway bridges.

#### 3.4.4.1 Special Studies

A baseline model, with added specific structural components, was created to capture the behavior of the bridge. The effects of removing those components can be seen the analysis with results seen in Figure 3-44. This model and the data from the load test is currently in a phase where it can be easily be continuously updated to reflect the state of the RRB.

As noted in the current bridge inspection report, there are no visible signs of deterioration or cracking, which caused the main focus of the parameter estimation to be the horizontal stiffness of the elastomeric bearing pads. Visual inspections will continue to be performed at RRB, and once there is noted deterioration, the model will be easily updated to model that change in behavior. The modeling of structural deterioration will also allow that deterioration to be quantified as a reduction in area, moment of inertia, or modulus of elasticity instead of a note on an inspection report.

The truck load mesh model used to apply the truck load provides a universal approach to truck load application to the bridge model. Using this technique allows a truck load at any location, with any load configuration to be applied to a monitoring based bridge model. This will

facilitate this model use for future load test and incorporation with future weigh-in-motion station for traffic excitation strain readings. Using weigh-in-motion, ramp meters, and loop detectors with digital image correlation will assist in provided a more continuous data stream in which to update the model or check current bridge conditions, knowing the current load on the bridge.

Including specific structural components into the monitoring based model that are not typically included in a design based model, allow for more accurate behavior to be captured in the model. Capturing the behavior more accurately allows for a much better comparison with measured data from a static load test. Using the load mesh and including specific structural components creates a monitoring based model that, as seen in the verification, can accurately capture bridge behavior while still maintaining usability in the model. This model will be handed over to the NHDOT of use by their bridge engineers in their everyday practices. The protocol used to create this model will consider incorporation into the bridge design and management program at the New Hampshire Department of Transportation and other bridge owners and managers.

#### **3.4.4.2 Integration with Intelligent Transportation Management System**

Part of the current transportation management system at the New Hampshire Department of Transportation is the employment of Geographic Information System (GIS) mapping to monitoring the infrastructure throughout the state. The GIS layers include flood warning, ice dams monitoring and excess traffic. Working in conjunction with the bridge design bureau, the bridge maintenance bureau, and the intelligent transportation bureau, the researchers are developing a GIS layer for SHM. This layer will include all of the instrumented bridges in New Hampshire. These bridges would each have corresponding calibrated baseline model that would be used along with AASHTO performance guidelines to define limits for bridge response. If the collected data exceeds these limits, an intermediate inspection and emergency repair, if needed, can be conducted by the bridge owner. This type of pro-active bridge management would be a more efficient allocation of bridge owner resources.

#### **3.4.5 References**

AASHTO. (2008). *Bridging the Gap -Restoring and Rebuilding the Nation's Bridges*.

AASHTO. (2004). *LRFD Bridge Design Specifications, Third Edition. 14.5 Bridge Joints*, pp. 14-8.

ASCE (2009). *2009 Report Card for America's Infrastructure*, ASCE, Washington. D.C.

Bailey, J., & Murphy, K. (2008). The Effectiveness of Fiber Reinforced Polymers in Modern Day Bridge Building. Eight Annual Freshman Conference (p. 5). Pittsburgh, PA: University of Pittsburgh.

Bowman, M. M. (2002). *Load Testing of the Carbon FRP Grid Reinforced Concrete Bridge Deck on the Rollins Road Bridge, Rollinsford, New Hampshire*. Durham, NH: University of New Hampshire.

Bowman, M. M., Yost, J. R., Steffen, R. E., & Goodspeed, C. H. (2003). Diagnostic Testing and In-Service Performance Monitoring of a CFRP Reinforced HPC Bridge Deck. *Second New York City Bridge Conference -Recent Developments in Bridge Engineering* (pp. 361-371). New York, NY: Bridge Engineering Association.

Brenner, B., Sanayei, M., Lattanzi, D., and Santini-Bell, E. "Defining a Baseline Model for Bridge Analysis and Design." (2006). *Proc. of 2006 Transportation Research Board*, No. 06-1593.

Brownjohn, J. M., Moyo, P., Omenzetter, P., & Chakraborty, S. (2005). Lessons from monitoring the performance of highway bridges. *Structural Control and Health Monitoring*, 12:227-244.

Bucher, C. and Frangopol, D.M. (2006). "Optimization of lifetime maintenance strategies for deteriorating structures considering probabilities of violating safety, condition and cost thresholds," *Probabilistic Engineering Mechanics*, 21(1): 1-8.

Chang, F.K. (2003). "Structural Health Monitoring 2003: From Diagnostics & Prognostics to Structural Health Management", Proc. 4 *International Workshop on Structural Health Monitoring*, DEStech, Stanford, CA.

Choquet, P., Juneau, F., & Bessette, J. (2000). New generation of Fabry-Perot fiber optic sensors for monitoring of structures. *SPIE's 7th Annual International Symposium on Smart Structures and Materials*. Newport Beach, CA.

Computer Structures, Inc. (2007, October). CSI Analysis Reference Manual for SAP2000<sup>®</sup>, ETABS<sup>®</sup>, and SAFE<sup>™</sup>. Berkeley, California, USA.

Cuehlo, E., Stephens, J., Smolenski, P., and Johnson, J. (2006). "Evaluating Concrete Bridge Deck Performance Using Active Instrumentation." *Proc. 2006 Transportation Research Board*, No. P06-2941.

Farhey, D. N. (2005). Bridge Instrumentation and Monitoring for Structural Diagnostics. *Structural Health Monitoring*, 301-318.

Feng, M.Q., Kim, D.K., Yi, J.H. and Chen, Y.B. (2004) "Baseline Models for Bridge Performance Monitoring," *Journal of Engineering Mechanics*, 130(5), 562-569.

Fu, G., Feng, J., & Dekelbab, W. (2003). *NCHRP Report 495 -Effect of Truck Weight on Bridge Network Costs*. Washington, D.C.: Transportation Research Board.

Gamache, Ronald W., (1995). "Topographical Mapping System for Radiological Environments," Mobil Mapping Conference, Columbus, Ohio, May 1995.

Gamache, Ronald and Santini-Bell, E.M. (2009). "Non-intrusive Digital Optical Means to Develop Bridge Performance Information." Proceedings of Non-Destructive Testing in Civil Engineering 2009, Nantes, France, June 30 - July 2.

GAO (2005). "Highway Congestion: Intelligent Transportation Systems Promise for Managing Congestion Falls Short, and DOT Could Better Facilitate their Strategic Use." United States Government Accountability Office.

GT Strudl. (2007). *Version 29*. Georgia Tech - CASE Center.

Haenni. (2008). Retrieved November 2008, from HAENNI Wheel Load Scales, a division of Baumer Borudon Haenni AG: <http://www.haenni-scales.com/e/>.

ISHMII (2006). "Structural Health Monitoring seen as essential for FHWA vision." International Society for Structural Health Monitoring of Intelligent Infrastructure. <http://www.ishmii.org/News/forFHWAvision>.

National Climatic Data Center. (n.d.). *Snowfall—Average Total in Inches*. Retrieved August 18, 2008, from <http://lwf.ncdc.noaa.gov/oa/climate/online/ccd/snowfall.html>

NHDOT Bureau of Bridge Design. (2007). *Bridge Inspection Report -Rollinsford 091/085*. NHDOT.

NHDOT Bureau of Bridge Design. (1999, July). Rollins Road Bridge Over B&M Railroad and Main Street Plans.

NHDOT. (2008, August 5-6). *New Hampshire bridges and related maintenance issues*. Northeast Bridge Preservation Partnership Meeting, Worcester, Massachusetts.

Office of Bridge Technology. (2008, August 18). *IBRC -Bridge*. Retrieved from FHWA: <http://www.fhwa.dot.gov/bridge/ibrc/>.

Petroski, H. (2007, August 4). Learning from bridge failure. *Los Angeles Times*.

Riad, M. Y., Shourky, S.N., and William, G.W. (2006). "Remote Health Monitoring and Modeling of Star City Bridge, West Virginia." *Proc. of 2006 Transportation Research Board*, No. P06-2843.

Santini-Bell, E. and Sanayei, M. (2005). "Using Multi-Response Parameter Estimation for Structural Condition and Risk Assessment of In-Service Bridges," *Proc. of ICOSSAR 2005*, Rome, Italy, No. 311.

Santini E. M., Sanayei M., Liu M., and Olson, L. D. (1999), "Bridge Foundation Stiffness Identification Using Dynamic Field Measurements." *Proc. of the 1999 Structures Congress*, April 18-21, New Orleans, LA, 316-319.

SAP2000. (2007). Version Advanced 11.0.7. Berkeley, California, USA: Computer and Structures, Inc.

Sipple, J.D. and Santini-Bell, E. M. (2009). "Accounting for the Impact of Thermal Loads in Nondestructive Bridge Testing," *Proceedings of the 2009 Transportation Research Board Annual Meeting*, Washington, DC, January 2009.

Stanton, J. F., Roeder, C. W., & Mackenzie-Helnwein, P. (2004). *Rotational Limits for Elastomeric Bearings Appendix F*. Washington: Transportation Research Board.

Stanton, J. F., Roeder, C. W., Mackenzie-Helnwein, P., White, C., Kuester, C., & Craig, B. (2008). *NCHRP Report 596: Rotational Limits for Elastomeric Bearings*. Washington, D.C.: Transportation Research Board.

Tadros, M. K., & Al-Omaishi, N. (2003). *NCHRP Report 496 -Prestress Loss in Pretensioned High-Strength Concrete Bridge Girders*. Washington, D.C.: TRB.

Trunfio, J. P. (2001). *Experimental Testing for the Use of Carbon FRP Grids in the Rollins Rd. Bridge, Rollinsford, NH*. Durham, NH: University of New Hampshire.

U.S. Department of Transportation. (2006). 2006 Status of the Nation's Highways, Bridges, and Transit -Conditions and Performance.

## 3.5 Bridge Vulnerabilities and the Practical Application of Advanced Composite Materials for Hardening, Strengthening, and Extending Service Life

*Amjad Aref, Ph.D.<sup>8</sup> and Jerome S. O'Connor, P.E., F. ASCE<sup>9</sup>*

### 3.5.1 Introduction

**B**y their nature, bridges are the most fragile link in the highway transportation system. The collapse of several bridges every year (New York State Department of Transportation, 2006) reminds us, as caretakers of the road infrastructure, that we have more to learn and more to do to safeguard the public. In addition to the need to assure safety, the smooth flow of people and transport of goods is essential to a strong and resilient economy. Some routes and bridges are considered “lifeline” routes because of their essentiality for public safety and commerce. Recent accidents and natural disasters, and the subsequent disruption to regional transportation have underscored the criticality of bridges. Hurricane Katrina (O'Connor and McAnany, 2008) is a recent example of the devastation and havoc that can result when bridges are rendered unserviceable by the forces of nature.

The catastrophic failure of several bridges in California, starting with the San Fernando earthquake of 1971, resulted in a substantial amount of research funding, subsequent revision to design codes, and development of seismic retrofit strategies. Since then great strides have been made in analytical methods for understanding the behavior of bridges subjected to the dynamic loadings imposed by earthquakes. There has also been extensive cooperation among nations, to help each other in this regard. Interestingly, the percentage of bridges worldwide that have failed from earthquakes is relatively small. According to New York State’s informal survey, almost two thirds have collapsed due to hydraulic action. Other bridge failures have been due to fire, vessel collision, vehicular collision, steel fatigue, and other issues. It is becoming increasingly apparent that we need to adopt an “all-hazards” approach to the design of bridges.

Protecting the motoring public who use the 585,000 *existing* bridges in the USA presents an immense challenge. The average age of the existing bridge population is about 42 years. This is significant because the philosophy for bridge design has changed significantly over that time period.

<sup>8</sup> Associate Professor, University at Buffalo

<sup>9</sup> Senior Program Officer, Transportation Research; MCEER, University at Buffalo

The layman might say that the majority of our nation's bridges are not "up to code." Obviously, it is impossible that we could magically make all of our bridges meet today's design criteria. Civil engineering, like all human endeavors, is an evolving art, continually changing. Still, we have an obligation to consider the need to retrofit the most vulnerable and most vital bridges, as much as resources allow.

Aside from its design falling short of today's standards, a 42 year old bridge is not in the same condition as a new bridge. In cases where the physical condition deteriorates because of environmental or other factors, the structure's integrity actually decreases over time.

The following list provides some important considerations relative to existing bridges. Bridges:

- Were often designed using a lower allowance for live load than is used for design today,
- Are being subjected to higher and more frequent truck loads than originally anticipated,
- Were not designed to handle the stresses induced by some hazards such as earthquakes, fire, or collision,
- Were frequently built without adequate protection from scour,
- Have details for welding that were designed without benefit of a full understanding of steel fatigue,
- Were built when the strength of materials was not as controlled and predictable as it is today,
- May have quality issues because workmanship may not have been well monitored (e.G., Field welding),
- Occasionally have weakened section properties because of inadequate maintenance and/or corrosion,
- Were not given proper maintenance for a good portion of their service life,
- May be considered historic; making major alteration difficult, even when it would improve performance,



Over the past 50 years, the U.S. government has spent billions of dollars on the development of composite materials.

The military, aerospace, and even the recreation industry have benefited from these advanced materials that are often superior to conventional materials, yet at a lighter weight. Fatalities of servicemen in Iraq and Afghanistan are substantially lower than previous conflicts as a direct result of protective body and vehicular armor made of composites. While the benefit is indisputable when it comes to the life of a soldier, the premium paid for these materials and other factors have deterred their acceptance into civil engineering practice. While dramatic improvements in the performance of our critical highway infrastructure are possible, there is still much to be done to leverage past research expenditures and adapt technology advancements for the prudent application of composite technology for civilian use.

**INFRASTRUCTURE TYPE:** Highway bridges

- Sometimes cannot realistically be rehabilitated without entirely rebuilding it,
- Still function under normal loads but cannot be expected to survive extreme loads as well as a new bridge,
- Were frequently not built with structural redundancy or continuity over multiple spans.

Table 3-6 presents some of the factors that must be dealt with by a bridge owner. From a broader perspective, the nation faces challenges related to economic competitiveness, reducing U.S. dependence on foreign oil, global climate change, environmental sustainability, and disaster resilience. These are explored in depth in (NRC 2009).

**Table 3-6: Challenges Facing Bridge Owners**

<b>Aging American Infrastructure</b>
Average age >42 years (vs. Typical design life of 50 years)
Many bridges are in a deteriorated condition
Age implies old design & geometric criteria
<b>Higher Load Demands</b>
Escalating demand for higher legal truck loads
Illegal overweight truck loads
Dynamic earthquake loads applied to bridges not designed to carry these loads
Terrorism threat
<b>Bridge Failures</b>
Can be due to condition or multiple hazard risk, or both
Occur primarily due to flooding
<b>Essentiality</b>
Becomes most apparent after an event
Can change due to an event
Is a function of system redundancy
Is probably greatest after a disaster
Can change over time , depending on land development, etc.

During the author's tenure as a Bridge Management Engineer in New York State Department of Transportation, it became clear that bridge safety assurance entailed the close monitoring of existing structures so that the rate of failure (or rate of degradation) was acceptable. All



bridges deteriorate with age, and, if left to their own devices, will eventually collapse. What the condition inspection and risk-based bridge safety assurance programs (O'Connor 2000) are intended to do is to prevent catastrophic collapses and other unacceptably rapid changes in condition. This is why inspectors “flag” a bridge. A flag brings attention to a change that will negatively affect performance.

In order to insure that the rate of failure is acceptable, the number one thing that an owner needs is to “know” the bridge; i.e. to understand it. What condition it is in? How is this different from original construction and how will this change its performance? What modifications or unintended changes have occurred since it was built? Is it functioning according to the designer’s intent? What risks exist that were not accounted for by the designer? How is it functioning vs. today’s design standards? For example, is there a better understanding of potential earthquake forces today than when it was designed? Have truck loads and cycles increased from what the designer had assumed? A prudent bridge owner will want to take a comprehensive look at the actual loads on a bridge and its as-is capacity to resist them. Structural health monitoring is one means of collecting the data needed to better diagnose problems.



In order to insure that the rate of failure is acceptable, the number one thing that an owner needs is to “know” the bridge; i.e. to understand it.

There are numerous scenarios that could compromise the integrity of a bridge and its ability to carry traffic. Table 3-7 provides a partial list of potential modes of failure.

History has shown that when a complete bridge failure occurs, there is usually one dominant hazard that promulgated the collapse of a bridge, but there is usually more than one contributing factor. For instance, a bridge failure may occur with an event that applies load to a bridge before some deteriorated condition or previous damage has been corrected.



History has shown that when a complete bridge failure occurs, there is usually one dominant hazard that promulgated the collapse of a bridge, but there is usually more than one contributing factor.

**Table 3-7: Potential Bridge Failure Modes**

<b>1.</b>	<b>Dropped span due to loss of support at a pier due to:</b>
a.	Undermining of the foundation from scour
b.	Loss of a pier due to vehicular or vessel collision
c.	Plastic hinging from earthquake loading
d.	Inadequate support length (also referred to as seat width)
e.	Toppled bearings
<b>2.</b>	<b>Severe deformation of one or more primary members due to:</b>
a.	Impact from vehicular or vessel collision
b.	Fire underneath (usually resulting from spilled fuel from a vehicular collision)
c.	Earthquake
<b>3.</b>	<b>Excessive tipping of an abutment or pier due to:</b>
a.	Scour
b.	Soil liquefaction
c.	Vessel collision
<b>4.</b>	<b>Excessive lateral displacement such that the structure is unusable. This might be due to:</b>
a.	Wave force and/or flooding
b.	Earthquake loading
<b>5.</b>	<b>Structural failure of a member due to:</b>
a.	Inadequate design for today's loads
b.	Brittle fracture resulting from fatigue
c.	Ductile fracture from overload
d.	Stress corrosion
e.	Localized deterioration
f.	Excessively localized loading
g.	Lack of freedom of movement due to corrosion
h.	Unintentional displacement of a member (e.g., a pin in a pin and hanger assembly)
i.	Loss of prestressing in a concrete beam after being subjected to uplift due to buoyancy forces
j.	Loss of prestressing in a concrete beam due to corrosion

### 3.5.2 Potential Role for Composites

The Federal Highway Administration (FHWA) has defined a vision for a “bridge of the future” by listing general performance requirements. Composite materials have characteristics that can help meet these objectives.

The Federal Highway Administration (FHWA) has defined a vision for a “bridge of the future” by listing general performance requirements.

- Life cycle cost is a fraction of the current expectation.
- Construction time is a fraction of the current time.
- Material degradation is no longer an issue.
- It is immune to attack from floods and earthquakes.
- A total systems approach is used in their design.
- They are adaptable to new demands.

Composite materials provide benefits that will allow new bridges to possess many of these qualities. They can also be used to enhance the performance of existing bridges and extend their useful life. FHWA has established a “Fiber Reinforced Polymer (FRP) Virtual Team” of advocates and maintains a web site with useful material and project information (FHWA 2009).

On bridges, composites have been used for:

- Internal concrete reinforcement (bars or grid material),
- Externally applied reinforcement (bonded laminations or near-surface mounted),
- Entire bridge components such as girders, slabs, decks, tendons, aerodynamic wind fairings, and
- Hybrid applications such as in wood laminates.

The American Concrete Institute (ACI) is one of few organizations that have produced documents to provide guidance to engineers who want to use these new materials with concrete. Some are:

- ACI 440R Report on Fiber-Reinforced Polymer (FRP) Reinforcement for Concrete Structures.
- 440.2R-08 Guide for the Design and Construction of Externally Bonded FRP Systems for Strengthening Concrete Structures.
- 440.1R-06: Guide for the Design and Construction of Structural Concrete Reinforced with FRP Bars.

- 440.4R-04: Prestressing Concrete Structures with FRP Tendons.
- SP-257: FRP Stay-In-Place Forms for Concrete Structures.

The state bridge engineers who belong to American Association of State Highway Transportation Officials (AASHTO) have a technical committee to facilitate sharing of information on the subject and have recently approved a guide specification for FRP pedestrian bridges (AASHTO 2008). Work is progressing on a similar guide specification for highway bridges.

Figure 3-45 illustrates how composites were used to provide external confinement to cracked and spalled bridge columns to enhance safety and extend the functionality of the Court Street Bridge in Owego, NY until a capital project could be developed. NY 14260

Fiber reinforced polymer composites used on bridges to date have been comprised of E-glass fiber with polyester or vinyl ester resins or carbon fiber with epoxy resins. Non-organic composites have been explored, but have not yet found their way into in-service bridges. High strength steel wire shows great promise for hardening structures against blast loading when used in lieu of glass or carbon fiber.

Composites are engineered materials with their characteristics dependent on a multitude of factors such as fiber type, orientation and percent volume, resin type, manufacturing method, and any bonding materials used in final assembly or installation. The strength, stiffness, and shape, and uses are open to one's imagination. This presents an opportunity in that knowledgeable professionals have the freedom to find more creative

solutions to problems, unconstrained by current product availability. The use of *performance* specifications works well because it leaves the door open for these innovative approaches to problems and allows designers to tailor the product to specifically serve the purpose at hand. On the other hand, standardization of some products will make economies of scale more obtainable.



Composites are engineered materials with their characteristics dependent on a multitude of factors such as fiber type, orientation and percent volume, resin type, manufacturing method, and any bonding materials used in final assembly or installation. The strength, stiffness, and shape, and uses are open to one's imagination.



Figure 3-45: Court Street Bridge, Owego, NY: a) top left, steel retrofit to prevent steel corrosion from splitting the pedestal apart; b) top right, application of fiber reinforced polymer wrap to confine the deteriorated column; c) bottom, structural configuration of the 70-year-old bridge.

### 3.5.2.1 Composites for Bridge Decks and Superstructures

Currently, bridge decks made of composite materials cost more than conventional concrete decks. However, comparing costs on a unit area basis does not always give a true indication of value. The unique properties of composite materials give them certain advantages that can still make the technology a prudent choice for bridge decks and superstructures.

One important benefit is derived from the *prefabricated* nature of composite decks when installing a factory-made deck, rather than constructing one in place and waiting for it to cure is *speedy construction* with *shorter traffic delays* (Figure 3-45). This improves safety for workers and the

traveling public. An environmentally controlled factory setting also lends itself to an improvement in *quality*. The Federal Highway Administration is encouraging modular construction as a means of meeting tax payers' demands for *less environmental and economic impact* resulting from construction projects (e.g., less delay, wasted fuel, noise, and pollution). Additionally, because of the short time needed to fabricate a bridge and



**Figure 3-46:**  
Prefabricated FRP deck being installed on prefabricated prestressed concrete beams. Bettendorf, Iowa.

the possibility of stockpiling standard sizes, a project's initiation and the planning phase can be dramatically decreased. This can be a big benefit in emergency situations. Establishing standard bridges for mass production could also simplify the purchase of these modular units to allow installation by smaller agencies with small work forces and light equipment.

Another spectrum of benefits stems from the *light-weight* nature of FRP. Weight savings over concrete can allow the conversion of dead load to live load carrying capacity. Instead of 120 psf for a typical concrete deck, a bridge can be designed for 30 psf or even less. On a rehabilitation project, the weight savings can result in an improvement in load ratings, possible

removal of weight restrictions and restoration of full service even after factoring in the reduced capacity of a steel superstructure due to section loss. Use of a light deck can also allow widening to accommodate an additional lane, shoulder, or sidewalk without requiring major improvements to the substructure.

A steel truss bridge carrying NY route 367 over Bentley creek was rehabilitated in 1999. The project exemplifies the dramatic improvements that can be made to old bridges by reducing the dead load. See Figure 3-47. The existing 170 psf concrete deck (with asphalt overlays) was replaced with a 33 psf composite deck 14" thick. With relatively minor structural work, the bridge was put back into service and a 14 Ton weight restriction was removed. By replacing 265 Tons of dead load with a light weight system, the live load capacity of the bridge doubled and ended up being higher than the original design rating. The rehabilitation project was completed years before a complete replacement would have been, was done for at least a million dollars less, and was done with minimal disturbance to the environment. The project team was recognized by ASCE's Civil Engineering Research foundation with the 2000 Charles Pankow Award for innovative technology applications.

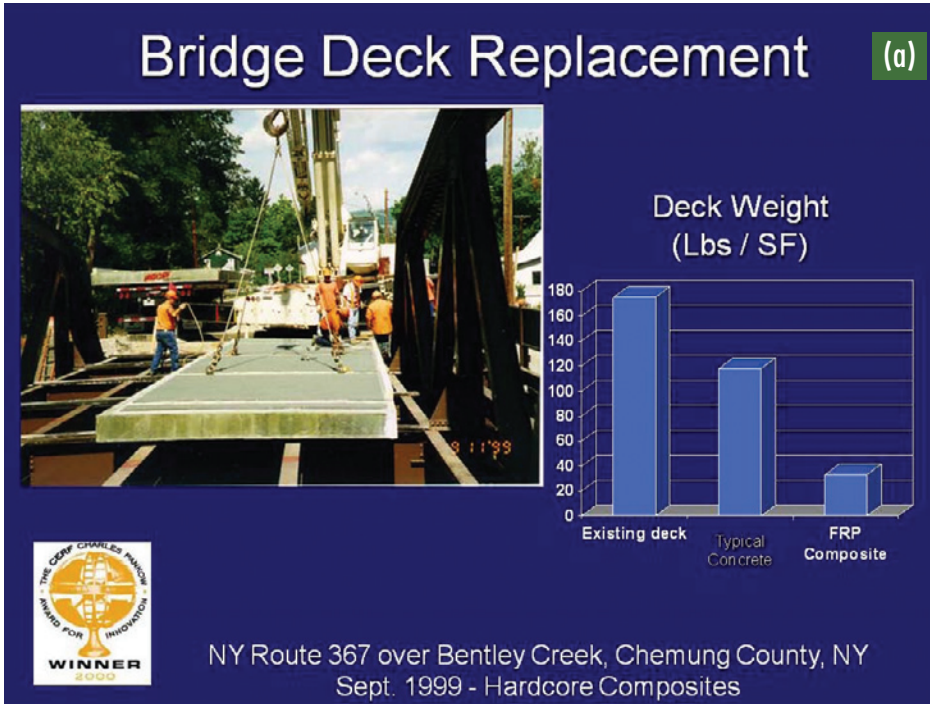
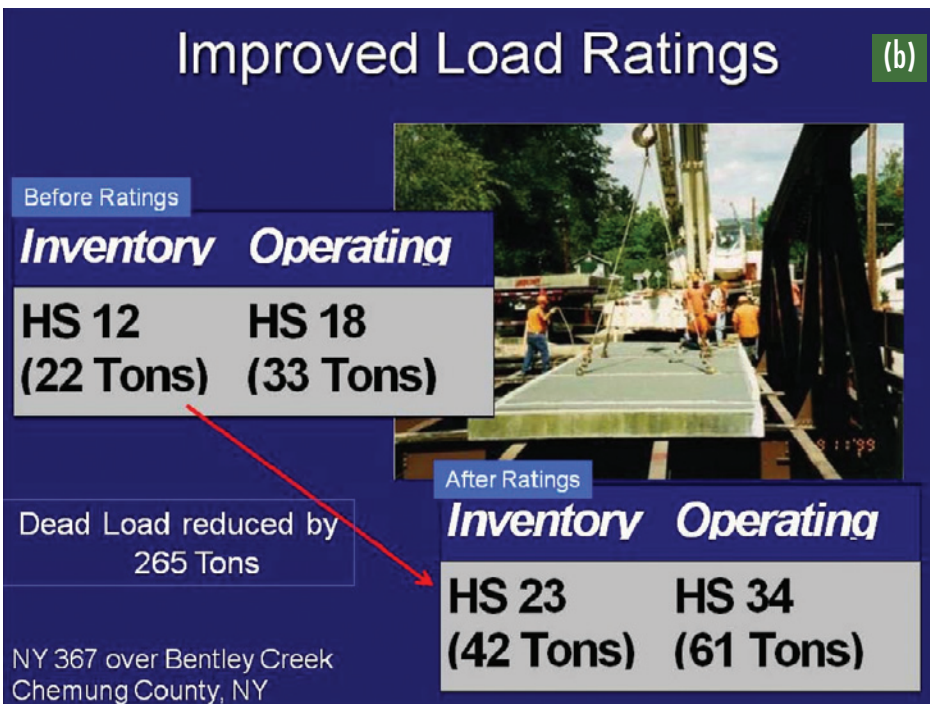

Figure 3-47:  
(a) Composite Decks Weigh 25%-30% of Conventional Decks and, (b) Live Load Capacity Can Often Be Improved Dramatically



On new construction, the weight savings might *lower foundation requirements* (e.g. fewer or smaller piles). The reduced mass also provides a substantial reduction in *earthquake induced displacements*. This is particularly helpful on elevated structures or those in proximity to a fault.

Composite decks offer the potential for long service life.

Composite decks also offer the potential for *long service life*. Though they have yet to undergo the test of time, the fact that they do not crack like concrete or corrode like steel suggest that they will last for many years with little maintenance. Concrete decks are typically predicted to last 25 years before requiring replacement. Today, design life of FRP decks is comfortably set at 75 years (i.e. the life of the bridge). De-icing salt is not a problem for a properly detailed FRP system. Noticeably, over half of FRP deck projects in the USA have been in the states of West Virginia, Ohio, and New York where the use of de-icing salts has led to the premature deterioration of many existing concrete bridge decks and steel bridge superstructures.



The properties of composite bridge elements can be tailored to meet the requirements of the job by changing the fiber architecture.

The properties of composite bridge elements can be *tailored to meet the requirements* of the job by changing the fiber architecture. By varying the fiber type, density within the matrix, number of layers, and orientation, the strength of a deck can be customized in each direction. By engineering the material, most efficient use can be made of each constituent, thereby optimizing the overall system and improving cost effectiveness. Although this may not be worthwhile on a project by project basis, a manufacturer's deck design can easily be tailored to certain classes of bridges to match required load and deflection criteria.

The benefits of prefabrication, weight, and *corrosion resistance* make composite materials a good material for certain types of bridges.

Project cost savings can be realized when composites are used judiciously. For instance, if it is possible to rehabilitate an old steel truss bridge using composite material, a complete bridge replacement can be avoided, resulting in substantial savings. This “fixes the problem” and frees up funds for use on other deficient bridges.

Certain bridge types are well suited to FRP decks. *Historic bridges* particularly benefit from light-weight decks. These older structures were often designed to accommodate a light (e.g. timber) decking material and need a product of similar weight when rehabilitated. Using a high-tech material like FRP offers advantages unavailable when replacing in-kind. The FRP system is most often *water-tight* and provides protection to the flooring system below. In contrast, timber decking is prone to leakage that can lead to premature corrosion of lightly designed steel members. The composite system also can accept a thin, light, skid resistant wearing surface that can further improve live load capacity.



Movable bridges are a particularly good application for FRP decks. Whether for rehabilitation or new construction, the lower weight can decrease *lift requirements*, resulting in lower capital, operating and maintenance expenses while at the same time reducing the potential for excessive displacements during earthquake induced ground motion. Figure 3-48 shows an example on such an application on a critical bridge.

Some of the potential benefits of composites for bridge construction are summarized in Table 3-8:



Figure 3-48. Schuyler Heim Lift Bridge Long Beach, CA

Table 3-8: Potential Benefits of Composites

a.	Accelerated construction with the use of prefabricated deck panels, structural members, approach slabs
i.	Increase work zone safety by reducing exposure time during construction
ii.	Reduce loss of productive time, air pollution, and wasted fuel stemming from traffic congestion
iii.	Environmental benefits associated with the quick installation of pre-fabricated bridge components
b.	Extend the life of conventional concrete by inclusion of corrosion resistant FRP rebars instead of steel.
c.	Increase live-load carrying capacity of existing bridges by
i.	Replacing concrete decks with FRP that weighs 70% less
ii.	Strengthening girders with exterior reinforcement <ol style="list-style-type: none"> <li>1. Externally applied laminations to concrete</li> <li>2. Near-surface mounted reinforcing</li> <li>3. Improvement of deteriorated steel members</li> </ol>
d.	Column wrapping to resist damage from vehicular collisions or explosives
e.	Safety improves because of providing reserve strength (extremely high operating rating) at little extra cost. This enhances the structures' ability to survive unanticipated overloads without damage.
f.	Extend service life
i.	Obtain service life of >100 years on new bridges by eliminating use of materials that are vulnerable to corrosion
ii.	Wrapping deteriorated concrete columns as a short term remedy
iii.	Wrapping unreinforced masonry columns to provide necessary confinement
iv.	With application of polymer concrete wearing surfaces to protect conventional concrete decks (most often without the addition of fiber). With little additional weight, these overlays can restore skid resistance, seal water and salts from cracks in concrete decks, slowing down the rate of corrosion.

Table 3-8: Potential Benefits of Composite (cont.)

g.	Improved seismic performance
i.	Increasing confinement and ductility of reinforced concrete columns
ii.	Reduction of moment by decreasing the mass of the bridge and/or deck
h.	Long term monitoring
i.	Embedment of sensors and smart materials during fabrication

### 3.5.3 State of the Practice

Over the past 10 years, there have been hundreds of instances where composites were used to improve the performance of bridges or to demonstrate the feasibility of the technology. While the overwhelming majority of these applications can be deemed a success because they are performing well structurally, there is still room for improvement. For

instance, initial cost has been higher than for conventional materials. Although benefit can often be shown in terms of life cycle costs, the time-honored practice of awarding contracts to the low-bidder makes it difficult for these new materials to compete.

Additional value can be obtained with the use of FRP decks, although they are not so easily identified and quantified by an economic analysis. Further reasons to consider their use are:

- FRP can make the salvage and restoration of a historic structure possible.
- Quick and easy installation means less disruption to the environment (e.g. air and noise pollution).
- Speedy construction results in decreased inconvenience to the user.
- There is less maintenance required due to resistance to chemical attack.
- Alternative procurement methods become available because of their pre-manufactured nature. A bridge deck can be purchased and installed instead of built on site. This type of product delivery can result in less administrative cost and a shorter project development phase.



Over the past 10 years, there have been hundreds of instances where composites were used to improve the performance of bridges or to demonstrate the feasibility of the technology.

- They can lessen a structure's vulnerability to dynamic loads such as earthquakes.
- Several manufacturers are willing to provide a product warranty which is not typical for the construction industry. A department of transportation (DOT) agency frequently discovers defects in construction projects within a few years of completion, but since it is well beyond formal project acceptance, they are forced to accept the consequences. Using manufactured projects with a warrantee can eliminate some of the problems intrinsic to field construction.

At this point in time, composite technology seems most suitable for trusses, historic structures, bridges originally designed for light loads, bridges to be widened, bridges where the superstructure is in good condition but the deck is poor, bridges that can be rehabilitated with a complete FRP superstructure and the abutments are salvageable, bridges where a low dead load is desirable, movable bridges, emergency bridges and temporary, rapidly deployed bridges.

There are certain disadvantages associated with using composites at the present time. Initial cost is probably the largest barrier to widespread use of these materials. Even when there is a valid case for their use, it is not always obvious that FRP provides a better value. For instance, consideration of user costs and life cycle costs is not always practiced by transportation agencies trying to allocate resources with a limited amount of construction funding.

Initial cost is probably the largest barrier to widespread use of composite materials.

Composite materials have a low modulus of elasticity when compared to steel and concrete (~3,000 ksi vs. 29,000 ksi). When used for bridge decks, this has a direct affect on the stiffness of the panel. In order to meet serviceability requirements for deflection, the deck systems are inevitably over-designed from a strength perspective. This reserve strength can be considered "insurance" against overloads or potential loss of an intermediate support so it provides benefit, but at additional cost. New shapes, manufacturing methods, and hybridization with other materials may lead to a more optimal design, but for now, a high factor of safety is the norm and this is counter to economical design.

Similarly, uncertainty over material properties gives rise to conservatism and subsequently higher cost. Until manufacturing methods become adopted that assure consistency in material properties that are verifiable with standard testing methods, specification writers will need to write a tight specification to insure the finished product will be safe and reliable.

Because of its complexity, a new deck design typically requires a finite element analysis. This type of analysis is not typical of conventional decks and is not a skill set normally found within a typical DOT. Bridge owners have ethical responsibilities that prevent them from accepting a “black box” design without fully understanding its behavior but the analysis and testing required of unique designs adds costs that make them even more uncompetitive. However, to date, manufacturers have not demonstrated a desire to produce a shared standard design. These proprietary interests inhibit acceptance by practicing engineers who are not experts in composite materials and prefer to stay with well understood materials rather than venture into the world of new materials and fiber architecture. Since they also need to be considerate of the cost of their services to the bridge owner, it is reasonable for them to take this approach. This also protects them from a perceived increased liability stemming from the use of a non-standard, relatively unknown commodity.

#### 3.5.4. Research Needs

Although FHWA’s past funding programs (Innovative Bridge Research and Construction Program and Innovative Bridge Research and Development Program) provided incentive to state DOTs to explore the potential of composites, the hurdles are substantial enough that activity and interest slowed down when funding dried up. The Transportation Research Board developed a strategic plan under NCHRP Project 04-27 (TRB 2003) which highlights some areas that need attention. The list below is a sampling of some topics, based on the authors experience and involvement in some implementation projects. Some relate directly to composites, some are of a more general nature.

- Comparison of life cycle costs of various project alternatives
- Use of intelligent transportation technology for enforcement of weight limits, similar to ticketing for running red lights
- Development of standards and format for data to be stored in a national repository to document bridge failures
- Identification of new materials to help meet objectives of AASHTO bridge engineers strategic goals
- Thermal properties of various composite materials (both global and local)
- Short and long term characteristics of adhesives used in composite product assembly
- Bonded and mechanical connections
- Deflection control strategies

- Selection, grading and durability of resins and adhesives
- Local deformation under wheel loads
- Wearing surface selection and installation (Figure 3-49 illustrates a debonding problem)
- Optimization of bridge railing to composite deck connections
- Fatigue
- Accounting for long term degradation of material properties
- Methods of inspecting and monitoring
- Integration of fiber optic and other sensors during fabrication for long term performance monitoring
- Repair, strengthening, and stiffening structural members in existing steel bridges
- Prevention of sudden failure due to creep rupture
- Changes in a bridge's global response to dynamic loading after relieving dead load
- Potential use of reclaimed materials



Figure 3-49:  
Wearing Surface Debonded  
from FRP Deck

### 3.5.5 Conclusion

Although there have been many successful bridge applications over the past ten years, owners and engineers have been slow to embrace advanced materials for bridges because of the higher initial cost, short track record in the industry, a lack of standards, lack of thorough understanding, and some unexpected learning experiences. Recent interest in smart infrastructure investment and more environmentally friendly solutions opens the door to highly effective use of these materials in the “bulk” applications that is typical of civil works such as highway bridges. This can be achieved by “dumbing down” the high performance and correspondingly high expense of aerospace grade materials for use in “down to earth” uses. Technology transfer between industries and bridge-specific applied research can help bridge the gap and pave the way to safer, cost-effective, and more durable and longer lasting bridges.

### 3.5.6 References

AASHTO (2008). *Guide Specifications for Design of FRP Pedestrian Bridges*, First Edition, <http://www.transportation.org> Washington DC

FHWA (2009) <http://www.fhwa.dot.gov/bridge/frp/>

Lee, G.C. and O'Connor, J.S. (2008). “Improvement of Bridge Safety through Forensic Studies,” *Design of Highway Bridges Against Extreme Events: Issues, Principles, and Approaches*, ed. George C. Lee, Mai Tong and W. Phillip Yen, MCEER-08-SP06, pp. 71-86.

National Research Council (2009). “Sustainable Critical Infrastructure Systems—a Framework for Meeting 21st Century Imperatives,” Washington DC

New York State Department of Transportation (2006). *Bridge Collapse Database*, Albany, NY, October 2006.

O'Connor, J. (2000). “Bridge Safety Assurance Measures Taken in New York State,” *Transportation Research Record, TRB and NRC*, eds., 1(1696), pp. 187-192.

O'Connor, J. and McAnany, P. (2008). “Damage to Bridges from Wind, Storm Surge and Debris in the Wake of Hurricane Katrina,” *Volume 5, Bridges*, MCEER-08-SP05, MCEER, University at Buffalo, <http://mceer.buffalo.edu/publications/Katrina/default.asp>

Transportation Research Board (2003). *NCHRP Report 503*, “Application of Fiber Reinforced Polymer (FRP) Composites to the Highway Infrastructure, Strategic Plan,” Washington, DC

### 3.5.7 Disclaimer

The views presented are the authors’. Although the perspective evolved through years of personal experience on past projects, this paper is not intended to reflect the position or policy of MCEER, University at Buffalo, New York State Department of Transportation, or Federal Highway Administration.

## 3.6 Managing Aging Bridges and Their Networks

*R. B. Testa,<sup>10</sup> H-C. Wu,<sup>11</sup> M. J. Garvin,<sup>12</sup> and B. Yanev<sup>13</sup>*

### 3.6.1 Introduction

The management of a bridge network in an urban setting, such as that of New York City, must continually integrate a large number of projects into several overlapping infrastructure networks, including vehicular, rail, energy, water supply, sanitation, and others. The size, density and hence, the importance of the assets are comparable to those of other major metropolitan centers (as well as those of smaller states).

Bridge management has as a principal aim the mitigation and minimization of potentially adverse effects of the deterioration and the consequent

In 2009 approximately 2200 bridges carry vehicular and train traffic over and between the five boroughs of the City. 787 are City-owned, and 600 are managed by the State. The Port Authority of New York and New Jersey operates the airports and several major facilities, including the George Washington and Bayonne Bridges. The Metropolitan Transit Authority is responsible for the subways and many bridges, the Verrazano, Whitestone, Throg’s Neck, and Triborough among them.

10 Department of Civil Engineering and Engineering Mechanics, Columbia University, NY

11 Formerly, Columbia University, currently Kunshan, Jiangsu, China

12 Myers-Lawson School of Construction, Virginia Tech, Blacksburg, VA

13 Executive Director, Bridge Inspection & Management, New York City DOT



Deterioration of bridges is related directly to how maintenance and repair (M&R) are managed. M&R management

must be considered on a network level if optimal performance is to be achieved. This paper outlines a life-cycle cost model in which the maintenance protocol supplies the basic variables, which are linked to a simple bridge network model to generate optimized network objectives. A genetic algorithm is used to identify potential strategies that can be evaluated using managerial preferences. The explicit role played by aging of bridges and the vulnerability concerns associated with the deterioration are not addressed directly, but the model presents a framework for their inclusion.

**INFRASTRUCTURE TYPE:** Highway bridges

Various bridge management systems (BMS) have been developed in the past several decades. In the United States, Pontis is the most widely used.

This software package, commercially available since 1992, was developed by FHWA (the Federal Highway Administration) with the assistance of

increasing vulnerability of bridges which becomes all the more pressing in an aging infrastructure such as found in New York City. These bridges may be considered as individual elements of the infrastructure or as parts of networks within the infrastructure thereby encompassing broader needs and objectives. Insightful management is crucial for both prevention and correction of deterioration effects. Such management generally means planning and budgeting for routine preventive maintenance and repairs which has, heretofore, been the realm of managers with knowledge and experience acquired over a long period of time, often by trial-and-error. A quantitative decision support system can provide valuable structure and transparency to the process of evaluating alternative strategies in order to select an optimal one. The challenge is not only to identify the basic variables and objectives, but how they may be related quantitatively beyond solely subjective and qualitative assessment. Some knowledge or estimate of the effect of maintenance and repair on deterioration with age is needed to do this. Ultimately, one should integrate real time health monitoring and status assessment into such a quantitative model. However, the direct relationship of basic variables to the objectives is not well established nor, for that matter, is it deterministic. For example, the main objectives or priorities might be the safety of the public and the condition of the bridge stock, which correlates with the quality of service provided, but none of these properties is uniquely defined. Moreover, the effect of a basic variable such as a maintenance or repair task on the deterioration and vulnerability of a bridge or network is not well determined or uniformly applicable. This is a key element of the quantitative management tool. Other factors and objectives which are also not well quantified or correlated will also affect decisions, including costs and budgetary limitations, financial and social impact on the community and risks from other than natural events.

Various bridge management systems (BMS) have been developed in the past several decades. In the United States, Pontis is the most widely used.



California DOT and Cambridge Systematics Inc.<sup>14</sup> In New York City, management decision support is provided by the NBI and the New York State Department of Transportation (NYS DOT) databases which provide inspection generated bridge condition information on several fronts:

- **Structural condition rating.** The National Bridge Inventory (NBI) gives structural condition on a scale of 0 (failed) to 9 (new) while NYS DOT uses a scale 1 to 7. Unlike the NBI system, the final single number rating for the entire bridge requires every structural component in every span to be rated in the NYS DOT system, with a weighted average combining the worst ratings of 13 key structural components throughout a bridge leading to the overall condition rating.
- **Load rating.** Load rating is obtained through calculations based on the design of the structure and the reported departures from the as-built condition. The qualitative condition ratings inform about visible deterioration before this quantitative load rating assesses a structure as functionally deficient.
- **Potential hazards.** Potential hazards, structural or safety, seen as such during inspections are “flagged” for either urgent prompt interim action or for lower priority monitoring until the next regular inspection.
- **Serviceability rating.** Serviceability appraisal assesses the quality of service as influenced by structural conditions, but depends also on factors that include importance, obsolescence, and poor geometric alignment.
- **Vulnerability.** This rating anticipates hazards that include hydraulic, seismic, collision, overload, steel details, concrete details, and sabotage.
- **Sufficiency rating.** Sufficiency is an overall rating combining structural (55%) and serviceability (30%) factors, weighted by importance (15%). The correlation with structural condition rating for 600 vehicular bridges in NYC is illustrated in Figure 3-50.

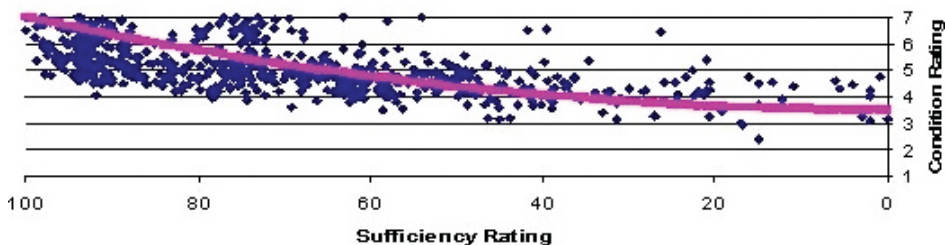

Figure 3-50:  
Condition and Sufficiency  
Ratings for 600 Vehicular  
Bridges in New York City

14 Cambridge Systematics, Inc. *Pontis Modeling Approach Overview*, 2004

While all of these assessments and others influence bridge management decisions on both the local and network levels and they should be quantified in an analytical decision aid, they are clearly not of equal significance or tractability. The condition ratings are the logical starting point to pave the way for models that will be more comprehensive. The present work uses the NYS rating system and is based on an earlier study conducted for New York City bridges<sup>15</sup>. The definition and quanti-

fication of the basic variables are derived from that work and applied to a model for life-cycle costs developed in <sup>16</sup>and modified for application from a bridge network perspective.



When it comes to developing a strategy for sustaining a mixed population of interdependent bridges a manager must consider not only what is best for a single bridge, but for the system.

When it comes to developing a strategy for sustaining a mixed population of interdependent bridges a manager must consider not only what is best for a single bridge, but for the system. In order to develop realistic M&R strategies, a BMS must first identify the maintenance and repair tasks, how bridges in a network deteriorate, and how that deterioration rate is affected by M&R. Ultimately, the objectives of a bridge network manager must be defined and then linked quantitatively to the correlation between M&R strategies and deterioration of the bridge network over time. For instance, if one identifies minimizing cost while maintaining aesthetics as objectives, the effect of predicted deterioration rates for various M&R strategies can be assessed to determine an appropriate strategy in view of these two objectives.

Ultimately, the objectives of a bridge network manager must be defined and then linked quantitatively to the correlation between M&R strategies and deterioration of the bridge network over time. For instance, if one identifies minimizing cost while maintaining aesthetics as objectives, the effect of predicted deterioration rates for various M&R strategies can be assessed to determine an appropriate strategy in view of these two objectives.

The work presented below is intended to summarize the quantification of key variables and parameters that go into the decision process for bridges and to provide the base for inclusion in a deterioration model the factors of aging and hazards not heretofore included explicitly. For a single bridge, a life-cycle model is reviewed. Additional factors and competing objectives that vie for management consideration in a network of bridges are considered with a genetic algorithm approach to search for optimal solutions. In addition, an aid to evaluating competing optimal solutions by considering perceived priorities by management and society is outlined.

<sup>15</sup> *Preventive Maintenance Management System for New York City Bridges: Technical Report No. 98-1*, Columbia University Department of Civil Engineering and Engineering Mechanics, New York, 1999

<sup>16</sup> R.B. Testa, B. Yanev, *Bridge maintenance level assessment*, *Computer-Aided Civil and Infrastructure Engineering* 17 (2002) 358-367

## 3.6.2 Single Bridge Life-cycle Cost Model

### 3.6.2.1 Deterioration and Life

The basic variables used in the NYC model are summarized in Table 3-9 which lists 13 standardized components, not all of which are present in every bridge, and 15 preventive maintenance tasks. The latter are distinct from component repair and overall bridge rehabilitation or reconstruction, which are taken into account separately by a protocol to be specified. Not all components have the same influence on bridge condition and the relative importance can be specified by coefficients  $k_{ej}$  for each component  $j$  ( $j = 1 \dots 13$ ). This, for instance, would be used as a weighting factor multiplying component condition ratings  $R_j$  to obtain an overall bridge rating  $R$ .

Table 3-9: Maintenance Tasks and Components

#	Preventive Maintenance Tasks	#	Bridge Components
1	Debris removal	1	Bearings
2	Sweeping	2	Backwalls
3	Cleaning drainage	3	Abutments
4	Clean abutments& piers	4	Wingwalls
5	Clean open grating deck	5	Bridge seats
6	Clean expansion joints	6	Primary members
7	Wash deck & splash zone	7	Secondary members
8	Paint	8	Curbs
9	Spot paint	9	Sidewalks
10	Sidewalk & curb repair	10	Deck
11	Pavement & curb sealing	11	Wearing surface
12	Elect. device maintenance	12	Piers
13	Mech. component maintenance	13	Joints
14	Replace wearing surfaces		
15	Wash underside		

The 15 maintenance tasks in Table 3-9 are principal factors in the deterioration of bridge components with time although that dependence is not readily quantified nor is it exclusive of all other influences. The influence of each maintenance task  $i$  on maintaining the rating of each component  $j$  may be estimated by experienced personnel and expressed by a matrix  $k_{ij}$  which, when combined with the weights  $k_{ej}$  lead to the

relative importance  $k_{mi}$  of each maintenance task  $i$  to sustaining the bridge rating  $R$  and thus, to its importance in the deterioration of the bridge.

The level/frequency at which each preventive maintenance task should be performed is not a fixed value. A level thought to represent full maintenance for each task can be assumed as a reference and then maintenance levels  $M_i$  can be considered as a fraction of that reference. Values  $M_i = 1$  could then be said to represent full maintenance but values greater than one are not ruled out. The deterioration with time must be related to the level of maintenance, something that can only be estimated based on experience. If one can estimate average rates of deterioration from the life span of components at the extreme conditions when there has been “full” and no preventive maintenance (rates  $r_{jo}$  and  $r_{jI}$ ), a deterioration model can be estimated using, for example, a linear dependence in the equation



$$r_j = -dR_j/dt = (r_{jI} - r_{jo}) (\sum k_{ij} M_i) + r_{jo}$$

Other nonlinear dependence such as shown in Figure 3-51 can readily be considered.

Figure 3-51:  
Deterioration Rate Models

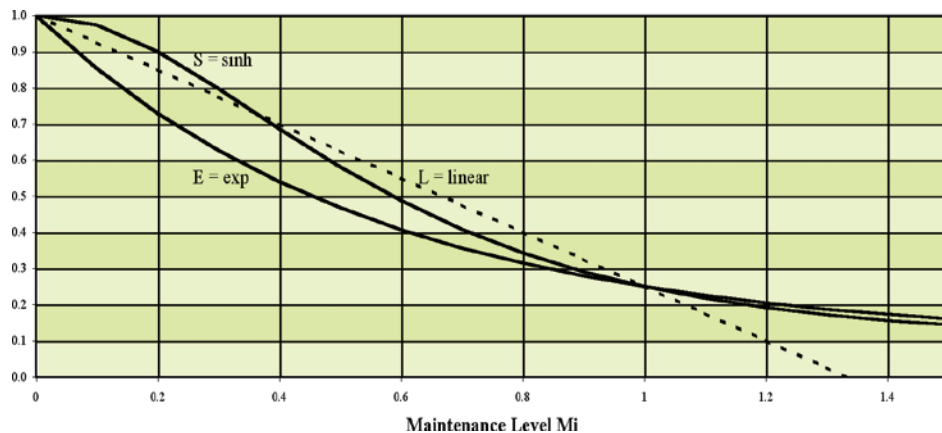

More importantly, this deterioration model does not include important factors such as environment and traffic, among others. For example, one might consider additional terms in the deterioration rate which account for traffic type and density, and for the specific environment of the bridge, and perhaps even a baseline rate applicable to the specific type of bridge for aging independent of maintenance and repair. Development of such an analytical expression of deterioration to include all factors is needed. Nevertheless, having the stated expression in this more limited form permits formulation of the overall model which can then be

extended to include all deterioration sources. The overall bridge deterioration rate  $r$  can be derived from the component ones as:

$$r = -dR / dt = \sum k_{ej} r_j$$



In these and subsequent expressions, the summations are taken over the full range of the 13 components ( $j$ ) or the 15 tasks ( $i$ ), as appropriate.

Another facet of bridge maintenance involves repair and/or replacement of individual components when they have failed or when they reach some critical level of deterioration ( $R_{jc}$ ) before their actual failure ( $R_j = 0$ ) but at which the component is deemed to be unserviceable. This should be distinguished from overall reconstruction or rehabilitation of a bridge when all components are restored. To this end, the model must specify the rating at which components will be scheduled for repair and by how much the rating of the component will increase by such repair, quantities that may be input to the model by a manager. Then, as the model computes the decreasing ratings with time depending on the specified maintenance levels  $M_i$ , the need for component repairs is monitored. Component repairs can be grouped at specified intervals (say 5 years) during the life of the bridge, with non-critical elements repaired at the next repair stage from the time they reach the repair threshold, while critical elements are repaired at the preceding repair stage. Such options could be selected in the model to explore various strategies.

A specified maintenance level together with a regimen for component repair thus permits construction of the entire history of component and bridge rating. From that history, the expected life of the bridge, that is, the time at which a failure rating is reached, is determined. In the present application, any one of four key components is deemed to control bridge life: primary members, deck, piers, and abutments. Moreover, it would be theoretically possible to extend the life of a bridge almost indefinitely by unlimited repairs of components but, in reality, the number of such repairs is neither feasible nor is it desirable in light of other age factors such as obsolescence of a bridge. In the model, the number of repairs to the four key components has been limited to two, but such a prescription might be obviated by inclusion of an independent aging component to the deterioration.

The expected life is thus a function of the repair regimen and the maintenance levels  $M_i$  and these determine the various annualized costs over the useful life of the bridge. It should be noted that the predicted life,  $L$  will not have a simple, analytical dependence on maintenance levels.

### 3.6.2.2 Life-Cycle Costs

The reference costs used in subsequent illustrations are those from NYC as discussed in earlier work.<sup>17, 18</sup> The costs can be expressed in current dollars so that all future costs are compared on an even footing. This obviates the need to account for the time value of money but does not account for such considerations as opportunity costs. The cost model includes:

$C_m$  = the annual unit cost of maintenance (per unit deck area) at the selected levels  $M_i$ ;

$C_C$  = total cost of corrective repair of components during the life time;

$C_R$  = cost of total major rehabilitation or reconstruction;

But there are other costs to be included, although their estimation is problematic. Among them are:

$C_U$  = cost to users because of restrictions resulting from bridge deterioration, closure for repairs, and other disruptions.

$C_{NY}$  = non-explicit cost to the community similar to ( $C_U$ )

In the life-cycle model, the maintenance levels ( $M_i$ ) of the fifteen maintenance tasks are the primary variables which also control the component deterioration and, thus, the need for repairs. All costs for maintenance, repairs, and replacement can be annualized over the computed life span including also hidden costs to users and community. That is not to say such costs are so well defined, but rather, that their potential effect can be observed and studied in the model. The life-cycle cost model gives annual costs of each of the expenditures as functions of the maintenance level. The dependence on the basic variables is not linear nor is it expressed in closed form.

### 3.6.2.3 Network Model and Objectives

For a network of bridges, a management aid must recognize the interactions among the bridges of the network. Therefore, the ensemble of network bridges should be considered which means that the number of decision variables (15 times the number of bridges) becomes large.

17 B. Yanev and R.B. Testa, "Useful Life of Bridges and Their Components in New York City," Proceedings of 8th International Conference on Structural Faults and Repair, July 1999, London, UK.

18 R.B. Testa and B. Yanev, "Annualized Life Cycle Costs of Maintenance Options for New York City Bridges," Fourth International Conference on Bridge Maintenance, April 2000, Guildford, UK.

In a network, costs to users and ultimately to the community are tied to delays encountered on the network when there is maintenance or repair activity. Those estimated user costs in the life-cycle model are sensibly replaced by consideration of traffic delay time in their stead which then becomes a key parameter for the network. The topology of a network of bridges describes the spatial correlation and connectivity within the system and form an important aspect of the delay analysis as well as any consideration of vulnerability of the network. In the present work, only a simple network without multiple interconnections and bypasses is considered, nor are other complications like the effects of environmental conditions or traffic accidents taken into account explicitly.

For a network of bridges, a management aid must recognize the interactions among the bridges of the network.

The impact of traffic delays from M&R activities is not readily quantified in the existing literature. User travel delay, representing cost to users and the community, may be estimated quantitatively by means of an empirical relationship<sup>19</sup> developed by the Transportation Research Board (TRB) to determine the effect of traffic capacity reduction from lane obstruction on travel speed. M&R activities have impact on users expressible in vehicle-hours (delay per vehicle) which, for the duration of each M&R activity, is equal to the additional time for a vehicle to traverse a lane-restricted work zone given by the bridge length plus some additional affected length of road. The duration of each M&R activity can be estimated from the size of the bridge and worker productivity dictated by the nature of each activity which also determines the required lane closures or other obstruction and, thus, the capacity reduction of the bridge

The delay per vehicle multiplied by the traffic volume gives the traffic delay time for users for one M&R event on one bridge. When summed for all M&R events for the specified maintenance levels ( $M_i$ ) and the resulting repair schedule obtained from the life-cycle model, and further summed for all bridges in the network, the total network delay time (T) is obtained. A maintenance strategy with more frequent maintenance and/or repairs will cause T to be larger and thus less desirable. A minimization of T, therefore, might be one of the desired objectives of a maintenance strategy for the network.

#### 3.6.2.4 Bridge Network Optimal Strategies

A variety of objectives as well as constraints can be identified in choosing a bridge management strategy. Extending the life of an existing bridge at an acceptable level of service is usually preferred over building

---

<sup>19</sup> Transportation Research Board, *Highway Capacity Manual*, Transportation Research Board, Washington, 2000.

a new bridge because bridge closure for replacement has greater impact upon regional traffic, requires significant capital, and often has political implications. Moreover, the viability of a bridge network relies on all of the bridges in the network and, therefore, if one bridge must be closed for replacement, the network may be crippled. Consequently, one might consider the life of the network to be governed by its weakest link. Then, managerial decisions on individual bridge maintenance will be influenced by the need to preserve the network. At the same time, economy and efficiency are always of concern when public funding is scarce so that cost in funding M&R for a system of bridges is an important management constraint. And certainly, effects on economics and satisfaction among users will be related directly to delays encountered on the network which must, therefore, be minimized. Therefore, three key objectives might be considered:

1. Maximize lifespan (L) of the weakest link and network;
2. Minimize maintenance and repair costs (C) over the life of a network;
3. Minimize impact/delay (T) from M&R in the network.

Other possible objectives might include minimizing vulnerability to natural and other hazards, sustaining appearance, limiting economic impact on the community, optimizing M&R scheduling, sustaining traffic flow, and to some extent, these are included in the above objectives. They can be isolated and included as distinct objectives but, clearly, they would need to be quantified as the three considered in this work are quantified for this analysis.

A binary-coded genetic algorithm (GA) is well suited to optimization for a system such as this which involves a large number of variables and is not formulated with closed form expressions capable of analytical solution. The GA evolves potential solutions toward an optimal frontier through mutation cycles with selection of the fittest solutions. To do so, the decision variables are encoded as binary strings. The number of binary bits (each bit a 0 or 1) in a string is determined by the number of possible values of each decision variable. In general, not all strings/variables need have the same number of bits. For bridges in a network, if each maintenance task  $M_i$  is limited to four possible levels, task  $i$  might be encoded as a string using only two binary bits, namely one of the pairs (0,0), (0,1), (1,0) or (1,1) representing maintenance levels  $M_i = 0, 1/3, 2/3,$  and 1 times full level. Fifteen such pairs define a maintenance protocol for a bridge and may be strung together to form a 15 string chromosome which might be called a bridge chromosome. If there are  $n$  bridges in a network, then  $n$  such bridge chromosomes can be combined in a string



representing the full network which might be designated the network chromosome (Figure 3-52). One network chromosome represents a maintenance strategy for the network, and the individual bridge chromosomes within it represent maintenance strategies for each individual bridge in the network.

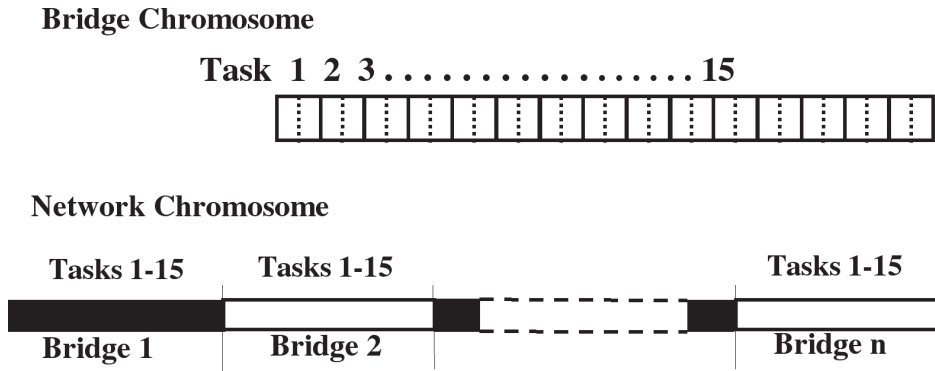

Figure 3-52:  
Chromosomes Defined

A set of 200 network chromosomes is generated randomly as initial trial solutions. For each chromosome (network maintenance strategy) the life-cycle cost model and the network delay model are used to track the cumulative cost and delay until such time as any one bridge in the network reaches a termination (end of its life) which becomes the network life. Thus each strategy yields values of life  $L$ , total cost  $C$  and total delay time  $T$  with the weakest link in the network determining its life. These are the values of the objectives for the strategy represented by that chromosome. The aim is to find strategies that maximize  $L$  while minimizing  $C$  and  $T$ . The process of selection of the better chromosomes which yield the better objective values and then from those, generating new chromosomes by gene exchange and mutation is the substance of the genetic algorithm. Here, the procedures used for selection and propagation are those of the Non-Dominated Sorting Genetic Algorithm (NSGA-II).<sup>20</sup> After a sufficient number of iterations (here 300), the process yields a relatively consistent final set of dominant chromosomes.<sup>21</sup>

The final set of dominant chromosomes represents optimal solutions (or pareto-optimal solutions) which best approach the desired objectives and, when there is not a single best solution to the problem, they tend to form a front or surface in the multi-dimensional space of the objective functions, in the present case, the 3D space  $L$ ,  $C$ ,  $T$ . Illustrations follow for simple bridge networks in which not all maintenance and/

20 K. Deb, *Multi-Objective Optimization using Evolutionary Algorithms*, John Wiley & Sons, LTD., England, 2001

21 H.C. Wu, *A Multi-Objective Decision Support Model for Maintenance and Repair Strategies in Bridge Networks*, PhD Thesis, Columbia University, New York, 2007.

or components are present. Baseline costs and other data used in these examples are taken for NYC as outlined in “Annualized Life Cycle Costs of Maintenance Options for New York City Bridges.”<sup>22</sup>

### 3.6.2.5 Three Concrete Bridge Network

For these concrete structures, some maintenance tasks (painting, spot painting, cleaning joints) and some bridge components (bearings, joints, piers) are not present, so in applying the optimization procedure to such a network, the number of potential solutions will be reduced and there will be fewer pareto solutions on the optimal front or, equivalently, fewer competing strategies from which to select. For the current example, the 24 final chromosome objective values together with the initial 200 values are shown in the 3-D space of the objectives in Figure 3-53. Because of the discrete steps used in the variables  $M_i$ , there are gaps in the pareto solutions and the optimal front in Figure 3-53 is not a smooth line.

Each point in the solution space represents a potential optimal strategy for a manager. As a rule, a manager will seek maximum return for expenditures—i.e. lower  $C$  for given  $T$  and  $L$ . In these results, the objective values of  $C$  and  $T$  increase with increasing objective value of  $L$ . Since none of the pareto solutions is quantitatively inferior to another by the measures adopted in formulating the problem, a manager must select a maintenance strategy by making tradeoffs among life, cost, and delay time.

### 3.6.2.6 Three Steel Bridge Network

This network has the same bridges as in the preceding but with added maintenance tasks (painting) for the steel. As a result, more potential optimal strategies are obtained (50 pareto solutions). Figure 3-54 shows the randomly selected initial chromosomes with the optimal front of pareto solutions which is now well defined.

### 3.6.2.7 More Complex Networks

With more complex networks, the number of pareto solutions becomes yet larger and there are more potential optimal strategies to be considered. For example, a 13 bridge network in NYC (the Henry Hudson Parkway) consisting of 13 mixed bridges, both in terms of material (steel and concrete) as well as dimension (number of spans). The pareto front for this network is shown in Figure 3-55.

---

<sup>22</sup> R.B. Testa and B. Yanev, “Annualized Life Cycle Costs of Maintenance Options for New York City Bridges,” Fourth International Conference on Bridge Maintenance, April 2000, Guildford, UK.

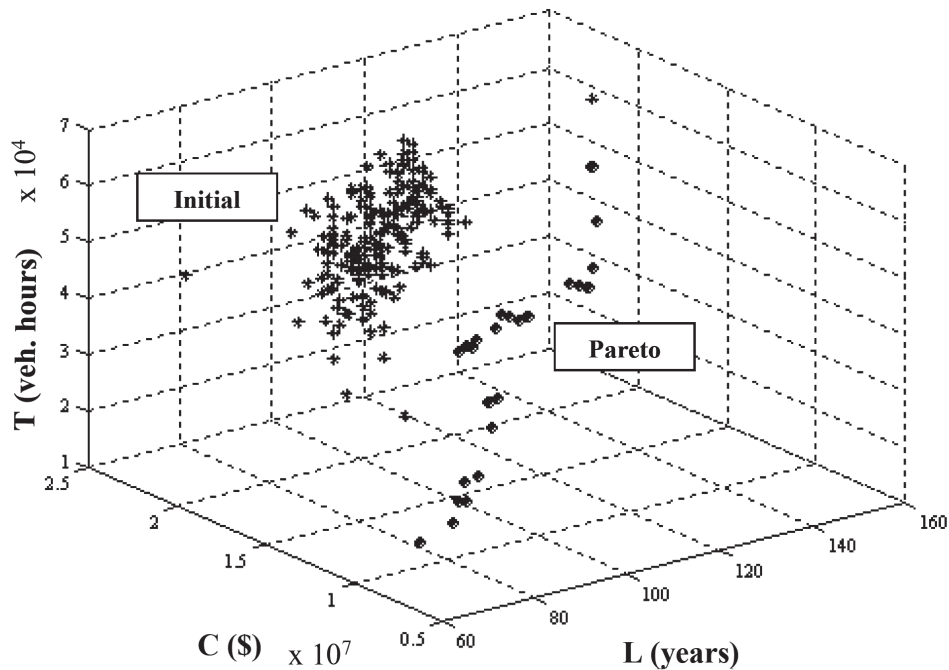

Figure 3-53:  
Three Concrete Bridge Network

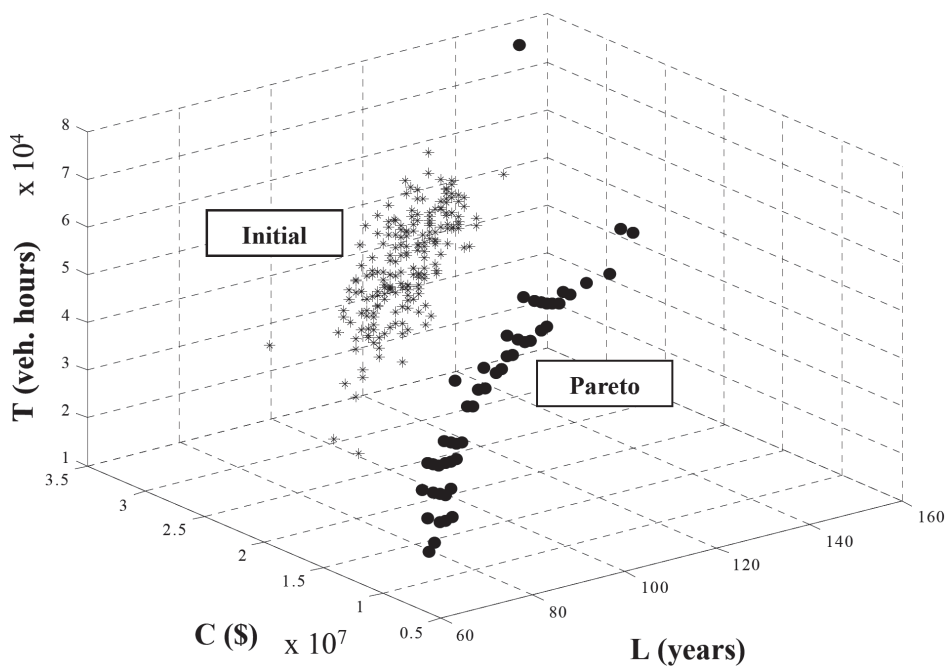
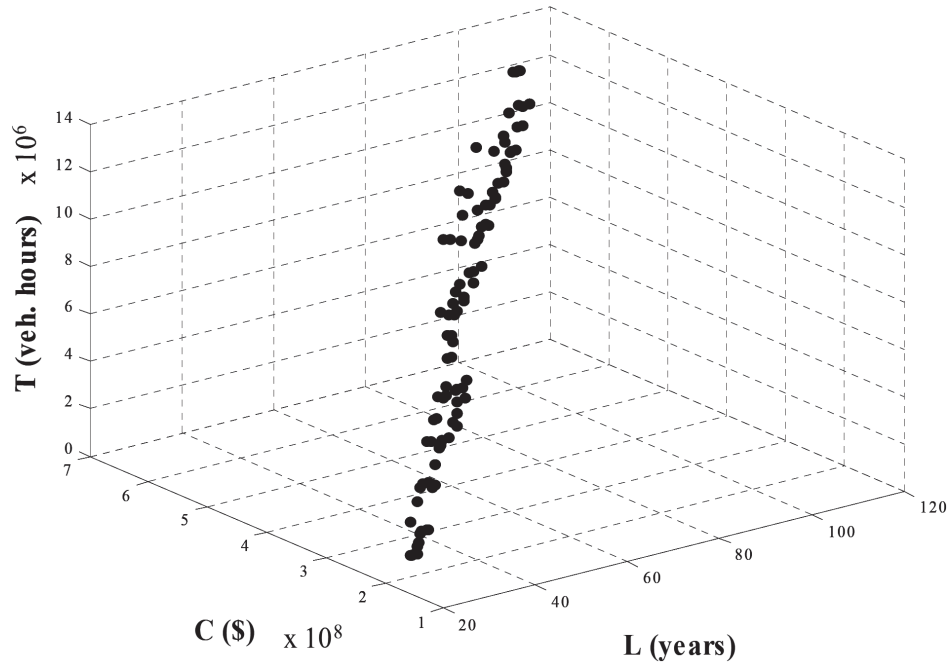

Figure 3-54:  
Three Steel Bridge Network

In addition to the fact that there are more bridges in this network to generate a larger population of solutions, there are also multiple bridges that are dominant either because of size or their low initial ratings. Such factors lead to more competition (or tradeoffs) among these bridges in terms of objective values and, thus, result in a greater number of pareto solutions, an indication that aging bridges in a network present greater managerial needs.

Figure 3-55:  
Complex Network



### 3.6.2.8 Selecting an Optimal Strategy

Here, there are three competing objectives whose relative importance a manager must consider in selecting an M&R strategy. In practice, the number of competing optimal strategies for a network may be narrowed when other managerial constraints are present. The pool of pareto solutions available for a manager's consideration will likely be limited by budgetary constraints. Placed under such constraints for budgetary reasons, a manager could opt for a strategy giving short life with low cost and low delay time or longer life and either least delay with higher cost or longer delay with lower cost. Or, a manager may balance all three objectives by choosing a strategy given by an intermediate point within the group of solutions. Or, if it is expected that a life projection beyond some specified number of years will be moot because of anticipated obsolescence that will require capital improvements, some constraint may be imposed on the network life used in planning. Or even, possibly for political reasons, there may be some limit imposed on the delays that will be tolerated in a network. In short, some range of potential strategies will be eliminated and others remain for managerial decision.

When there remains a large number of optimal maintenance strategies so that a clear decision by a manager remains elusive, a systematic strategy selection technique such as the Simple Multi-Attribute Rating

Technique (SMART)<sup>23</sup> might be employed to aid in decision. In this approach, the constraints and limitations are expressed quantitatively by means of the relative attractiveness to a manager of the objective values in the available pool of solutions which may have already been narrowed by the manager to an acceptable range. Desirability values (VL, VC, VT) for each of the objectives (L, C, T) at each point of the solution pool may be assigned from 0 to 100 according to a selected protocol which reflects the relative desirability of values in the optimal ranges. For example, the cost values C in some range of the solution pool may be deemed unacceptable and would be assigned a low desirability value. A manager can also assign weights to the various objectives (wL, wC, wT) according to the relative importance placed on the objective overall. By summing the combinations of desirability value and weight ( $wLVL + wCVC + wTVT$ ) for each pareto solution being considered, a benefit value is obtained for that potential optimal solution. Comparison of the benefit values which now include priorities and judgment of the manager can assist in selecting among the various optimal solutions by looking for the one with the maximum benefit.

### 3.6.3 Conclusion

Management of bridges must be done in the context of the network of which they are pivotal elements. Within that framework there are significant objectives to be formulated, of which the more obvious ones are cost and functionality, but it is equally important to formulate the response of each element over time to the variables being prescribed. Here, a set of objectives has been formulated and the dependence on the variables of maintenance encoded in a life-cycle cost model. The identification of potential strategies to achieve the objectives in an optimal fashion has been achieved using a genetic algorithm with guidance on selecting among the optimal solutions so generated.

Managerial decisions regarding maintenance and repair rely heavily on input regarding the condition of bridges over time, and health monitoring can play a dominant role in this, well beyond its primary goal of detecting damage and/or establishing the condition after an extraordinary event. And this applies even more emphatically when applied to a network of aging bridges. In the present model, as in the preceding life-cycle cost model, subjective estimates

This model, though realistic, is simplified because it does not include all possible variables and objectives, especially if one wishes to apply specifically to an aging infrastructure system where additional vulnerability to natural and unnatural hazards might be identified. However, it forms the basis for expanded application to such cases where competing optimal solutions may be more numerous and difficult to resolve.

23 P. Goodwin and G. Wright, *Decision Analysis for Management Judgment*, John Wiley & Sons, Ltd. (2004).

by experienced personnel have been used for deterioration predictions through the influence coefficients  $K_{ij}$ . To be sure, the values assigned to such coefficients and other quantities in the model that are not easily quantified will affect the numerical outcomes. This, as well as the non-deterministic nature of much of the information, is something that can be addressed once the model is formulated and tested in applications.

### 3.6.4 References

Cambridge Systematics, Inc. *Pontis Modeling Approach Overview*, 2004

*Preventive Maintenance Management System for New York City Bridges: Technical Report No. 98-1*, Columbia University Department of Civil Engineering and Engineering Mechanics, New York, 1999.

R.B. Testa, B. Yanev, *Bridge maintenance level assessment*, *Computer-Aided Civil and Infrastructure Engineering* 17 (2002) 358-367.

B. Yanev and R.B. Testa, "Useful Life of Bridges and Their Components in New York City," Proceedings of 8th International Conference on Structural Faults and Repair, July 1999, London, UK.

R.B. Testa and B. Yanev, "Annualized Life Cycle Costs of Maintenance Options for New York City Bridges," Fourth International Conference on Bridge Maintenance, April 2000, Guildford, UK.

Transportation Research Board, *Highway Capacity Manual*, Transportation Research Board, Washington, 2000.

K. Deb, *Multi-Objective Optimization using Evolutionary Algorithms*, John Wiley & Sons, LTD., England, 2001.

H.C. Wu, *A Multi-Objective Decision Support Model for Maintenance and Repair Strategies in Bridge Networks*, PhD Thesis, Columbia University, New York, 2007.

P. Goodwin and G. Wright, *Decision Analysis for Management Judgment*, John Wiley & Sons, Ltd. (2004).

# 4

# Prioritization, Decision-Making, and Management

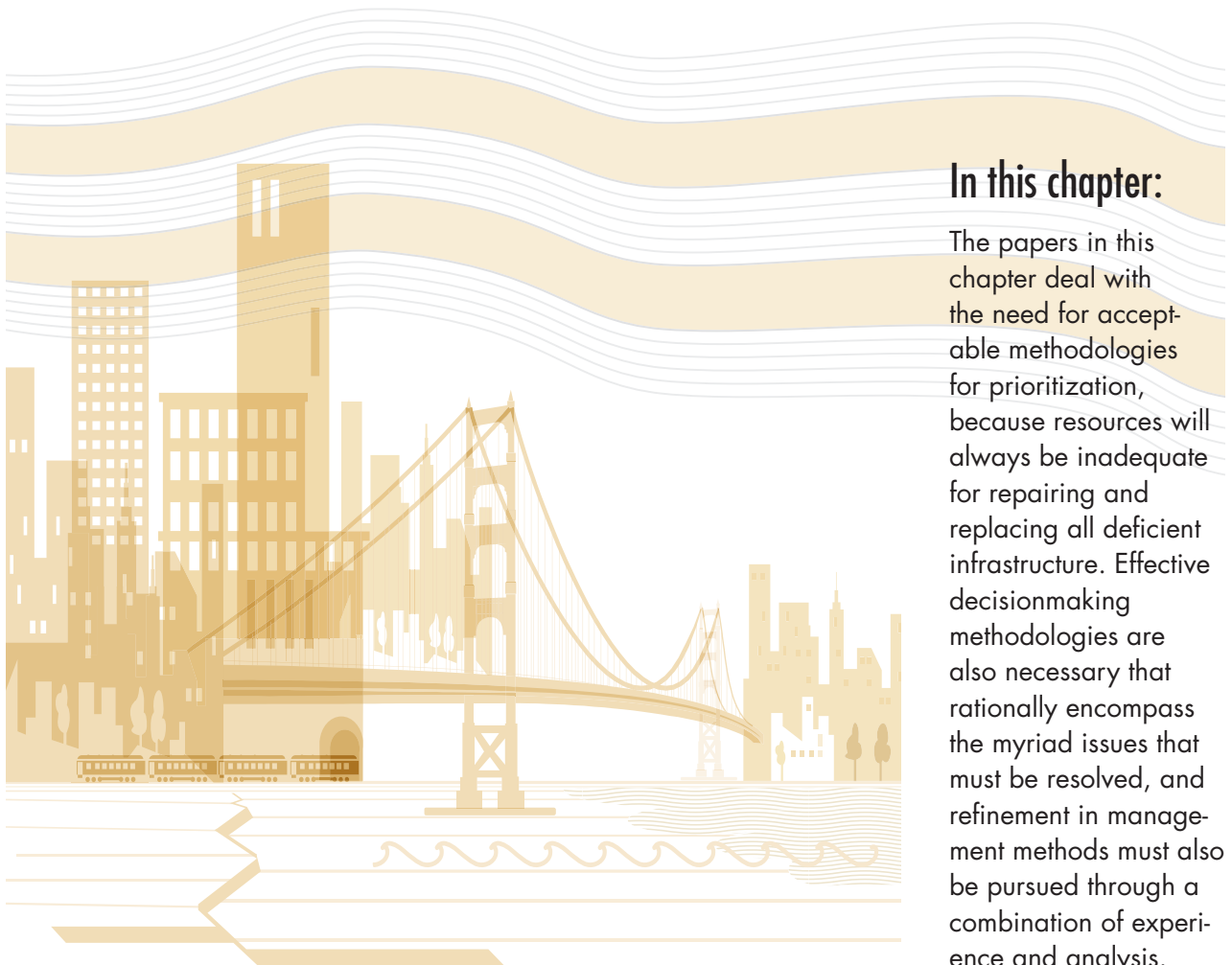

## **In this chapter:**

The papers in this chapter deal with the need for acceptable methodologies for prioritization, because resources will always be inadequate for repairing and replacing all deficient infrastructure. Effective decisionmaking methodologies are also necessary that rationally encompass the myriad issues that must be resolved, and refinement in management methods must also be pursued through a combination of experience and analysis.

The papers in this chapter deal with the need for acceptable methodologies for prioritization, because resources will always be inadequate for repairing and replacing all deficient infrastructure. Effective decisionmaking methodologies are also necessary that rationally encompass the myriad issues that must be resolved, and refinement in management methods must also be pursued through a combination of experience and analysis.

“Accelerating deterioration of America’s infrastructure and the crying need for new infrastructure to meet projected population growth—along with the worsening economic and employment climate—have stimulated massive new infrastructure investment. The Nation is, however, poorly prepared to prioritize and select investment options.” (Meisinger, Paper 4.1)



The papers in this chapter deal with the need for acceptable methodologies for prioritization, because resources will always be inadequate for repairing and replacing all deficient infrastructure.

“There is, however, no established decision-support technology to guide the valuation and selection of the optimal portfolio of projects to capture the full benefits of the spending... The needed technology is highly unlikely to be undertaken by any party other than the Federal government because of the currently vested interests, diversity of disciplines required for a more objective and rational approach, and the fact that the ensuing benefits will not be readily commercialized but will accrue to all Americans. If the technology were available and used, the Nation’s resulting infrastructure would be assuredly be more efficient, reliable, secure, resilient, and sustainable. But time is of the essence: significant outlays are underway and will continue at an accelerated pace.” (Meisinger, Paper 4.1).



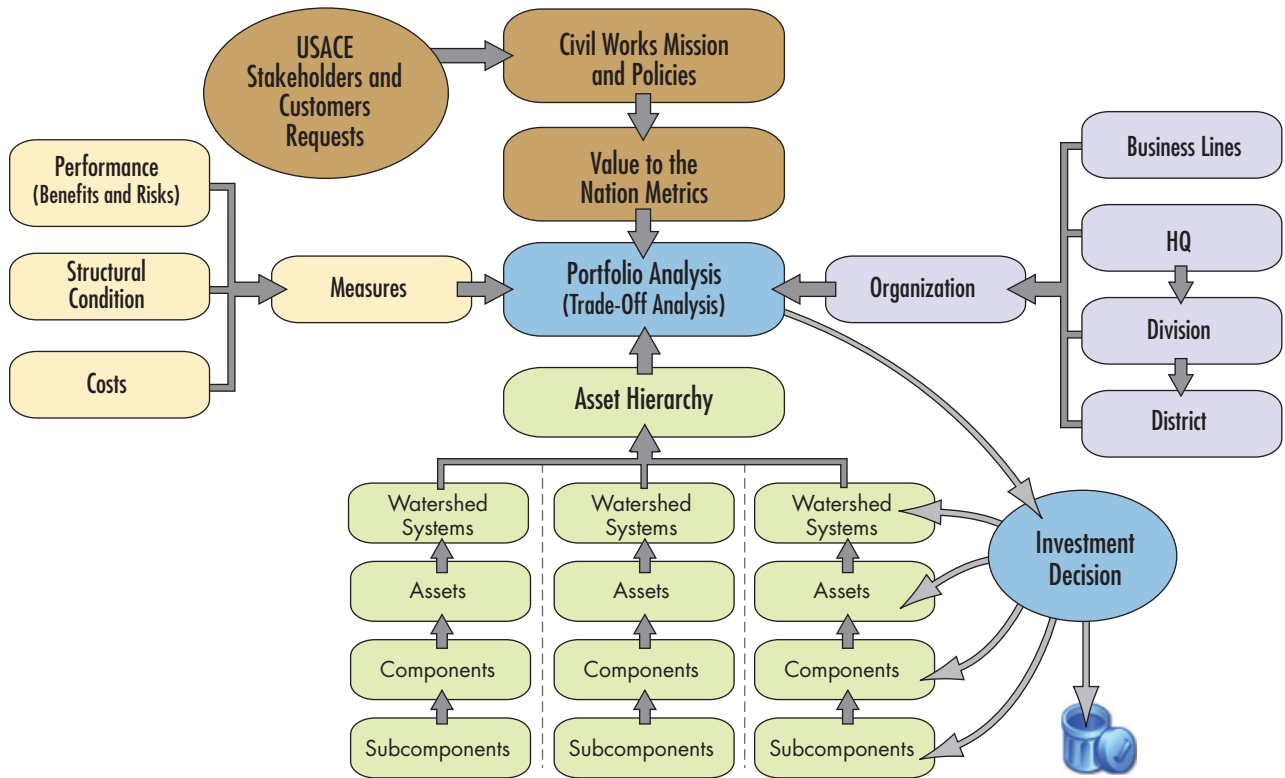

Figure 4-1: Five Aspects of Asset Management (Woolridge et al. Paper 4.3)

SOURCE: ASCE

### Paper 4.1 Decision Technology for Rational Selection of Infrastructure Investments: A Pressing Research Need and Grand Opportunity at an Historic Moment

J. Reese Meisinger

### Paper 4.2 A Threat Independent Approach to Evaluating the Sustainability of Our Critical Infrastructure

By Shalva Marjanishvili, Ph.D., P.E., S.E. and Eve Hinman, Eng. Sc.D., P.E.

### Paper 4.3 Five Integrated Aspects of Aging Infrastructure Management: A Basis for Decision-Making at the United States Army Corps of Engineers (USACE)

Richard W. Woolridge, Jose E. Sanchez, David P. Hale, and G. Edward Gibson, P.E.

### Paper 4.4 A Multi-Objective Approach for the Management of Aging Critical Highway Bridges

Z. Lounis, L. Daigle, D. Cusson, and H. Almansour



Papers

## 4.1 Decision Technology for Rational Selection of Infrastructure Investments: A Pressing Research Need and Grand Opportunity at an Historic Moment

*J. Reese Meisinger, ASME Innovative Technologies Institute, LLC*

### 4.1.1 The Problem and Opportunity

**M** myriad bureaucratic and political schemes have evolved for distributing appropriated funds that individually and collectively fall well short of rational allocation of public resources. The result is a massive opportunity loss as billions of dollars are potentially squandered.

*Time is of the essence:* significant investments are being made, and more billions of dollars will continue to be spent, regardless of the caliber of analysis supporting these investments. In order for the Nation to capture the full benefit of such outlays, the technology advocated in this paper must be done well, quickly and right the first time—or the opportunity is lost.

- **Area of critical national need and magnitude of the problem.** Hurricane Katrina (more than 1800 deaths and more than \$150 billion in economic losses) and the collapse of Minneapolis’s I-35 bridge (killing 13 and disrupting traffic and the local economy for a year) have stimulated public awareness of the necessity for accelerated programs of replacement, rehabilitation, and renewal. With passage of the stimulus package and allusions to future infrastructure funding, vast sums of money will be expended.

Money is not the only requirement for turning American infrastructure around. A major systemic shortcoming exists in the way we decide on infrastructure investments. The Nation is currently ill-equipped to make the needed priority and resource allocation decisions, so we risk spending trillions of dollars over the coming decades on the wrong decisions, buying the wrong infrastructure and missing a huge opportunity to get it right.

**Societal challenge.** Powerful vested interests have a stake in maintaining the current jumble of allocation schemes because they are in the position to exercise power, take credit, and/or receive funding. Starting with Congressional earmarking and horse-trading, through trust funds and federal agency formula grants, clear through to state and local elected and appointed officials’ final decisions, there is little or no comprehensive analysis of value, sustainability, risk, or resilience of potential infrastructure projects. Furthermore, certain individuals at each level profit from those arrangements. Availability of a competent, standardized

technology for valuing and prioritizing infrastructure investments would permit the adaptation of existing processes to provide a more rational analytic underpinning.

Further, there are few incentives for the needed research to be undertaken. Infrastructures are, almost by definition, networked and highly interdependent, so an improved valuation and selection method requires contributions from diverse disciplines and industries that seldom collaborate, making it unlikely that the needed research will be undertaken without Federal support. Ideally, however:

- Economists will contribute concepts of value, utility and regional modeling;
- Civil and mechanical engineers will bring sound security and resilience design processes;
- Systems engineers will supply systems models to capture distributed infrastructures and physical interdependencies;
- Decision and management scientists will provide portfolio methods and decision paradigms;
- Behavioral scientists will contribute user interfaces and organizational concepts to encourage use of the methods in actual decisions;
- Infrastructure experts will bring understanding of the technologies, cultures and legal/regulatory environment; and
- Decision-makers and analysts in the field will keep the methodology practical and useable.

**Transformational results and impacts.** The advent of a methodology that supports rational infrastructure decision-making would bring discipline to the jumble of processes by which America now makes these vital investments. It would reject “bridges to



Accelerating deterioration of America’s infrastructure and the need for new infrastructure to meet projected popula-

tion growth, along with the worsening economic and employment climate, have stimulated massive new infrastructure investment. The Nation is, however, poorly prepared to prioritize and select investment options. High-risk, high-reward research to define and develop a management process for valuing investments in new and renewed infrastructure would revolutionize the investment strategy of these massive outlays and transform the critical infrastructure base of the American economy for decades to come. This research could also incorporate dimensions of efficiency, risk, resilience, sustainability, and equity that are largely absent today.

**INFRASTRUCTURE TYPES:** Highways, bridges, dams, levees, water, waste water and electricity

To date, the combination of political and disciplinary barriers has resulted in there being no competent method for rationally undertaking these critically important decisions. Powerful forces benefit materially from the current jumble of allocation processes and the requirements for constructing new, more competent methods cover too broad and diverse a set of disciplines to be feasible in the absence of a concentrated Federal effort. The opportunity cost of continuing with the present system will be enormous as the Nation rushes to make investments that will entail jobs, while potentially wasting hundreds of billions or trillions of dollars.

nowhere” early in the process and treat “sunk costs” as gone (favoring repair over replacement) while introducing new technologies (materials, wear sensors, design concepts) in a context where their value is manifest. It would expose self-serving proposals and highlight those that are sound. It would enhance design of both new and renewal projects. It would elevate emerging values of safety, security, resilience, sustainability, and social equity to their rightful position as decision criteria.

In the near term, the quality and consistency of infrastructure investment proposals and plans would rise. The resulting infrastructure would clearly serve a full range of objectives—economic benefits and investment efficiency to the owner and to the community served, greater security, resilience, equity, sustainability, etc. The reality of interdependencies and the logic connecting the investment to the social benefits would be clearly addressed, options would be compared, and strategic portfolios would be defined on a regional and perhaps national scale.

Over the longer term, the outcomes could be measured by the quality of infrastructure services provided (e.g., less congestion, fewer “boil-water” announcements), the spread of infrastructure services to a growing population, reduction in the number and duration of service denials, and reduction of unit costs of the service as new, more efficient assets replace worn and obsolete ones).

In brief, such an approach would bring “more bridge for the buck.” It would delineate the difference between investing trillions of taxpayer dollars well or spending them poorly and bring about a significantly higher quality American infrastructure base than current processes can possibly consider. The results would vastly increase the efficiency and global competitiveness of American industry and contribute to the quality of life of all our citizens.

**Maps to Administration Policy.** A consensus clearly exists<sup>1</sup> that more investment in infrastructure is needed and that security and resilience should be among the design criteria. The Obama Administration has included in its economic stimulus package the largest investment in infrastructure since the creation of the interstate highway system under Dwight D. Eisenhower. The Administration’s budget proposal adds still more funding and advances controversial new appropriations processes. These billions of dollars for roads, bridges, water systems, etc., are only the beginning if the U.S. is to restore its fraying infrastructure to full capability.

---

1 Building America’s Future, national survey of registered voters, conducted by Luntz, Maslansky Strategic Research Analysis, January 5, 2009 summary memo at <http://www.investininfrastructure.org/Websites/investininfrastructure/Images/LuntzWebsiteMemo.pdf>.

As noted earlier, ASCE has estimated that \$2.2 trillion is required and that covers only a subset of our infrastructures.

The need for competent decision-support technology is at least as pressing, according to a distinguished bipartisan commission (which contained sitting Senators and governors of both parties) convened in 2006 by the Center for Strategic and International Affairs, and the findings of at least two bills introduced in the last Congress<sup>2</sup> and likely to be re-introduced. Rationally allocating such funds is complicated by long-standing, ingrained practices: “earmarks” for special projects; “trust fund” single-purpose financing of some infrastructures (e.g., roads) and the absence of such funds for others (e.g., drinking water); formulaic allocation of blocks grants; and the absence of a central clearing point or standard metrics for essential comparisons.

The commission concluded that: “America’s economic well-being and physical security depend on safe and reliable ... infrastructure... But we are both under-investing in infrastructure and investing in the wrong projects: *new investments are critically needed, but we lack the policy structures to make the correct choices and investments...* A centralized infrastructure project approval process would force all infrastructure modes to be evaluated using common methods and parameters” [emphasis in original]. No specific “common methods and parameters” are mentioned. The bills, in turn, call for “uniform criteria and procedures” and “transparency to ensure optimal return on public resources”—again, methods not specified—to establish objective, consistent analytic processes that yield directly comparable estimates of costs and benefits of alternative investments—the *sine qua non* of rational allocation of limited resources.

These voices are not alone. Title IX of the 9/11 Commission Recommendations Act requires establishment of a system of national standards, accreditation and certification to encourage business continuity (another name for resilience). The Sloan Foundation has mounted a major program to encourage continuity and resilience. As Judith Rodin, President of the Rockefeller Foundation commented:

We can build 21st century infrastructure and create jobs in the process. We can mitigate the climate change we’re causing, and develop clean, reliable, renewable, sustainable energy supplies.

---

2 Center for Strategic and International Studies Commission on Public Infrastructure, 2006; the National Infrastructure Bank Act (S. 1926) and the National Infrastructure Improvement Act (S.775).

We can build stronger resilience so people aren't left vulnerable to the wrath of a world that we know will continue warming no matter how many Hummers are traded in for Priuses. And so we must. We must do all these things in a way that widens the circle of opportunity.<sup>3</sup>

The American Society for Industrial Security, the International Standards Organization, the American National Standards Institute Homeland Security Standards Panel, and other groups are working to establish

The U.S. Department of Homeland Security has established a National Infrastructure Simulation and Analysis Center (NISAC) at Sandia National Laboratories, funded in the tens of millions of dollars annually to model infrastructures, with an emphasis on interdependencies. Its models have been used to respond to high-level requests for analysis, but have not been made available to infrastructure decision-makers outside the program. One of the NISAC models, the Critical Infrastructure Protection/Decision Support System (CIP/DSS), is chartered to build a capability that sounds much like the one advocated by ASME-ITI. The managers of CIP/DSS, like the managers of all the other NISAC models, have determined to build a model that requires a super-computer to run, massive quantities of sensitive data, and would be unavailable for outside use—all factors that make it ill-suited to meet the requirement described here. To our knowledge, there is no other effort underway to address this significant national challenge.

an environment in which security, continuity, resilience and risk management are commonplace. Independent advisory panels to the President and to the Secretary of Homeland Security in the last administration endorsed resilience as a national objective, an initiative also advanced by Business Executives for National Security. The National Research Council's Board on Infrastructure and the Built Environment will soon issue a report of an expert workshop that recommends urgent action on aging infrastructure. But no industry group, professional society, research organization, blue ribbon panel, or coalition has developed a technology for consistent, rational infrastructure investment valuation and selection.

The ASME Foundation awarded a modest grant of \$255,000 to ASME-ITI to conduct an initial project to develop a robust, rational methodology for evaluating the risks and resilience of aging infrastructure and the value and efficiency (benefit/cost) of investing in renewal and new infrastructure. ASME-ITI has convened a Working Group on Infrastructure Investment made up of distinguished engineers, economists, risk analysts, and infrastructure experts to define the problem and an approach to dealing with it. Issues of advanced technology (e.g., a self-healing power grid, stress

and fatigue sensors, new materials) and societal policy (e.g., community and environmental benefits) will necessarily be addressed in the context of assuring the viability and effectiveness of the methodology. To date, the Working Group has defined a set of design criteria and un-

3 Rodin, Judith, "Philanthropy's Role: Supporting a Bold, 21st Century Infrastructure, Agenda America 2050 Forum, Bicentennial of the Gallatin Plan, The Woodrow Wilson Center, Washington • Friday, May 9, 2008.

dertaken initial conceptualization of a solution. Its perspective and recommendations are reflected in this white paper.

**Recap.** In brief, America's infrastructure has been ignored for decades, is deteriorating, and is inadequate to support the population growth in the near future. The current economic crisis has underscored these issues, stimulating significant outlays of taxpayer dollars to generate employment in the near term. There is, however, no established decision-support technology to guide the valuation and selection of the optimal portfolio of projects to capture the full benefits of the spending. The only identified program of research covering any significant part of the challenge (i.e., the National Infrastructure Simulation and Analysis Center at Sandia National Laboratories and its (CIP/DSS) has made strategic decisions that will render it impractical. No source of funding other than the Federal government will likely fund this research because the application and benefits are so broad.

Time, however, is of the essence. Unless the necessary technology is developed and disseminated quickly, the Nation will miss the opportunity to harvest full benefit from its vast investments in renewal and new infrastructure.

Time, however, is of the essence. Unless the necessary technology is developed and disseminated quickly, the Nation will miss the opportunity to harvest full benefit from its vast investments in renewal and new infrastructure. A number of barriers—tradition, power relationships, personal perquisites, diversity and number of needed disciplines—militate against this research being undertaken, or, if undertaken, having the desired outcome. The sole solution is a concentrated Federal commitment. ASME-ITI has taken the initial step of organizing a panel of experts to define the needed technology and the R&D to develop it.

### 4.1.2 Overview Of The High-Risk, High-Reward Research

**High risk research.** As noted above, one of the barriers that must be overcome is the diversity of disciplines that must contribute in order for this research to succeed. There is no shortage of investment evaluation protocols for special purposes, for business investments or for public expenditures, provided that the cash flows and consequences are readily projected. Return on investment, value-at-risk, portfolio optimization, benefit/cost analysis, etc., are well defined and contribute valuable concepts to the needed technology. The challenge, however, is the inherent difficulty of valuing an asset that contributes to the well-being of an entire region in which it is economically interdependent with other infrastructures. In other words, the value to the public of an investment in new or renewal infrastructure is the contribution it makes to the economy it serves—evaluated in the context of the full set of infrastructures that serve the entire region.

### THE TECHNOLOGY TO BE DEVELOPED

The objective of this research would be to develop technology to provide decision-makers with the ability to review and rank investment options within a functional regional context. It would display estimates of a multi-criterion objective function (health, welfare, employment, economic, security, resilience, environmental and other key metrics of regional societal performance) and investment and operating costs under three conditions:

- (1) assuming no new investments;
- (2) with each investment option individually; and
- (3) with a selected set (portfolio) of new options added to existing infrastructure. The decision tool would ultimately support an infrastructure portfolio of existing, renewed, and new assets that optimize the economic function of the given area (metropolitan, state, regional, or national) relative to whatever budgetary constraints apply. The technology could be used by decision-makers at any of these levels.

This definition of value is further complicated by the need to incorporate issues of safety, security, resilience, sustainability, and equity, which are values germane to all public and many private investment decisions. Still further, the method must produce results that are directly comparable to assets both within a given industry and across industries. This is necessary to support tradeoffs among competing proposals. Finally, the sheer scale of executing such an approach cannot be addressed by most university research. These factors, taken together, make the recommended research too high risk for parties others than the Federal government (possibly in conjunction with not-for-profit trade and professional associations) to undertake. In any event, such a methodology must be made available quickly if it is to have a significant impact on the Nation's ongoing investment strategy.

The foundation would be a system of assessments of individual infrastructure assets based on their relationships and interdependencies. Investments would be justified on grounds of improved performance for any or all of the elements in the objective function, e.g., reduced congestion, enhanced resilience. The needed technology would apply to all new and renewal infrastructure investment proposals—at least those involving taxpayers' or ratepayers' funds—using consistent definitions, processes, criteria and metrics. The results obtained would be directly comparable before the

decision to invest in a given infrastructure and sufficiently operational to serve as performance evaluation criteria after the fact. Tailored versions are likely to be needed to account for the diverse technologies, cultures and traditions of individual sectors, but they must all result in directly comparable estimates of the ultimate value of a given outlay.

The methodology would focus squarely on the consequences of inaction versus those of investing in alternative solutions (the difference between them being the benefits of the investment). It would base the level of performance on each element of the multi-criterion objective function. It would place special emphasis on regional economic impacts, employment, sustainability, operational risk (lives, injuries, economic and financial losses) and resilience (time to recover functionality after disruption), as well as the benefits of reduced risks, enhanced resilience



and expanded economic well-being to the asset's owner and the particular area being served, whether city, state, region, multi-state region, or Nation. The methodology would assess each investment opportunity in a systems context, including how each asset interacts with others with which it is interdependent, and would consider non-structural (e.g., congestion pricing of highway access) and technological (e.g., "smart cars" spaced safely closer by electronic means) alternatives to structural solutions (e.g., wider roads).

**Scope of the technology.** The approach would integrate analysis of infrastructures at four levels:

- **Individual assets and facilities** that are socially critical or key elements of critical infrastructures.
- **Systems of facilities** and other assets that make up individual infrastructures, especially those that provide distributed services, e.g., power, water.
- **Cross-system regional system-of-systems** to capture dependencies and potential cascading failures.
- **Regional economic analysis** to capture all direct and indirect impacts on regional output, income and employment (without "double-counting" with the above models) of regional disruptions to judge the public's stake in the decisions—with extensions to higher levels, e.g., states, multi-state regions and the Nation.

The technology would be complex enough to capture the important dimensions with acceptable accuracy, but its application in data collection, asset modeling, systems modeling, and economic analysis would need to be as transparent as possible, available for "what-if" analyses. A crucial design requirement is that it could be carried out by local personnel, perhaps with some training, but not be in the province of experts alone. This last feature will be useful to building and maintaining credibility in the face of counter-intuitive results that are bound to crop up when interdependencies are analyzed on a regional scale.

**Expected new capabilities and outcomes.** The availability of this decision-support technology, especially if it took the form of an American National Standard supported by commercial grade software, would permit forward-looking infrastructure owners and public policy officials to apply the method to their own decision-making. For wider use, Congressional and/or Federal agencies could require a thorough analysis as a routine part of planning and applying for funding of infrastructure investments. This would be most easily done for competitive, selective grants, but could

also be applied to formula grants as part of due diligence. Infrastructures owned and maintained by the private sector would adopt the method as a way of negotiating rates and justifying new investments.

The major outcome of use of this new technology would be a marked increase in the value of investment in new and renewal infrastructures. Regional economies would expand in sustainable, equitable ways; safety, security, and resilience relative to man-made and natural events would be materially enhanced; cascading infrastructure failures would be less likely, less frequent and less wide-spread; and fewer “wring” projects would find funding.

**Path forward.** The research program to develop the needed technology would consist of the following broad phases:

1. **Requirements definition:** Conduct in-depth interviews with decision-makers at the respective levels to define the processes now in use, their needs and constraints, and refine the requirements that the technology must meet to be accepted and effectively applied. Obtain the commitment of a sample of decision-makers and key analytic/planning staff to participate in assessing and critiquing the technology as it is being developed.
2. **System design:** Refine the requirements into a detailed functional design to define the needed processes and system components.
3. **Component acquisition:** Search for or adapt/develop components required by the system design. ASME-ITI has identified at least two sources for each component defined to date that appear to be compatible, including:
  - Investment project characterization to define performance on most or all of the dimensions of multi-criterion objective function, investment and operating costs;
  - Geographic information systems and agent/systems analysis models to describe distributed infrastructures and their interdependencies;
  - Regional economic models to estimate direct and indirect impacts on regional output, income and employment; and
  - User-friendly graphic user interfaces to accept inputs, manage case analyses, drill down for details of specific infrastructures or systems, visualize results, and display the results for use in decision-making.

4. **Component integration:** Place each component in the designed process, enable fast, accurate hand-offs between components, and test the integration as an analytic system in a laboratory setting.
5. **Test/refine/build/retest:** Conduct a “spiral development” process to test the integrated analytic process with actual field data on a small-scale set of diverse investment options, critique and refine the process and expand it for larger application, and test it on a larger number of diverse investments. Repeat the sequence until the system performs adequately at the scale desired and accounting for all major infrastructures.
6. **Demonstration:** Conduct a demonstration project for decision-makers and their staffs who have not previously participated in the project using actual field data and critique its performance. Refine the technology to meet the criticisms.
7. **Training:** Develop and test user training packages for analysts and planners and a summary orientation for decision-makers.
8. **Dissemination:** Evaluate alternative dissemination options, e.g., publications, templates or protocols, voluntary consensus standards, Federal and/or state requirements, best practices.
9. Because of the urgency of making improved infrastructure valuation technology widely available, a spiral development plan should be used, putting simpler and cruder versions into use as soon as available, even as the more comprehensive processes are being refined and tested.

### 4.1.3 Conclusion

The Nation has determined to make long-overdue investments in renewal and new infrastructure. The usual processes for analyzing, prioritizing, and selecting projects are widely viewed as inadequate to obtain anything close to the full benefit of what could amount to trillions of taxpayer dollars. The needed technology is highly unlikely to be undertaken by any party other than the Federal government because of the currently vested interests, diversity of disciplines required for a more objective and rational approach, and the fact that the ensuing benefits will not be readily commercialized but will accrue to all Americans.

If the technology were available and used, the Nation’s resulting infrastructure would be assuredly be more efficient, reliable, secure, resilient, and sustainable. But time is of the essence: significant outlays are underway and will continue at an accelerated pace. The opportunity to capture the benefits of these vast sums could quickly pass, to the detriment of all. The recommended research is urgently needed and should be initiated as expeditiously as possible.

## 4.2 A Threat Independent Approach to Evaluating the Sustainability of Our Critical Infrastructure

*Shalva Marjanishvili, Ph.D., P.E., S.E. and Eve Hinman, Eng.Sc.D., P.E., Hinman Consulting Engineers, Inc.*

### 4.2.1 Introduction

**A**lthough it is possible to design critical infrastructure systems to resist virtually any threat, it is impossible to design these systems to resist all possible threats. While all current threats could be defined today, unknown future threats that may occur during the life of the structure cannot be defined. As a result robustness evaluation could be useful in prioritizing critical infrastructure for the purposes of allocating mitigation dollars that potentially allows for a way to optimize our infrastructure both sustainably and effectively.

### 4.2.2 Risk and Reliability

Risk of failure is a concept that can be universally understood by infrastructure stakeholders as well as engineers. A traditional definition of risk is that it is equal to the product of probability of failure (assuming that the threat has been executed) and cost of failure. Hence, probability of failure needs to be computed to determine the risk. For the purpose of this paper let us assume an infrastructure type similar to a transportation or communication system, where performance is measured by the successful delivery of freight or data. This infrastructure will have a defined Capacity to perform (denoted as C) and a variable Demand (denoted as D).

It is intuitive that the infrastructure Demand and Capacity are dependent of each other. That is, if the infrastructure system is overloaded (i.e., the Demand is too great), its Capacity to perform goes down and nothing or very little freight or data gets successfully delivered (i.e., it fails). Similarly, if the infrastructure system is underutilized (i.e., the demand goes down) then its Capacity to successfully perform also decreases significantly (i.e., it has become obsolete).



This paper describes the basic concepts used in probabilistic assessment approaches and an argument is made for using robustness and resiliency as the primary means for evaluating, repairing, and replacing our aging infrastructure in the 21st century. The terms reliability, resiliency, risk, and redundancy are often used to convey similar or the same concept in the literature. Typically, none of these terms are defined in a computationally rigorous manner. Each of these terms has a unique mathematical meaning. However, resiliency and robustness have the special distinction of being particularly powerful because they are completely threat independent.

**INFRASTRUCTURE TYPE:** All, using transportation and communications as example

To compute probability of failure, we have to define what constitutes failure. For our infrastructure example, let us assume that failure occurs when infrastructure is unable to fulfill its function, i.e., cannot deliver freight or data within acceptable parameters. Since demand and capacity are dependant variables, probability of failure for this infrastructure system is calculated as:

$$P_f = \int_{-\infty}^{+\infty} \int_C^{+\infty} f(C, D) dD dC \quad (1)$$

Where:  $f(C, D)$  is a joint probability density function for the infrastructure system. Figure 4-2 shows schematic view of this function.

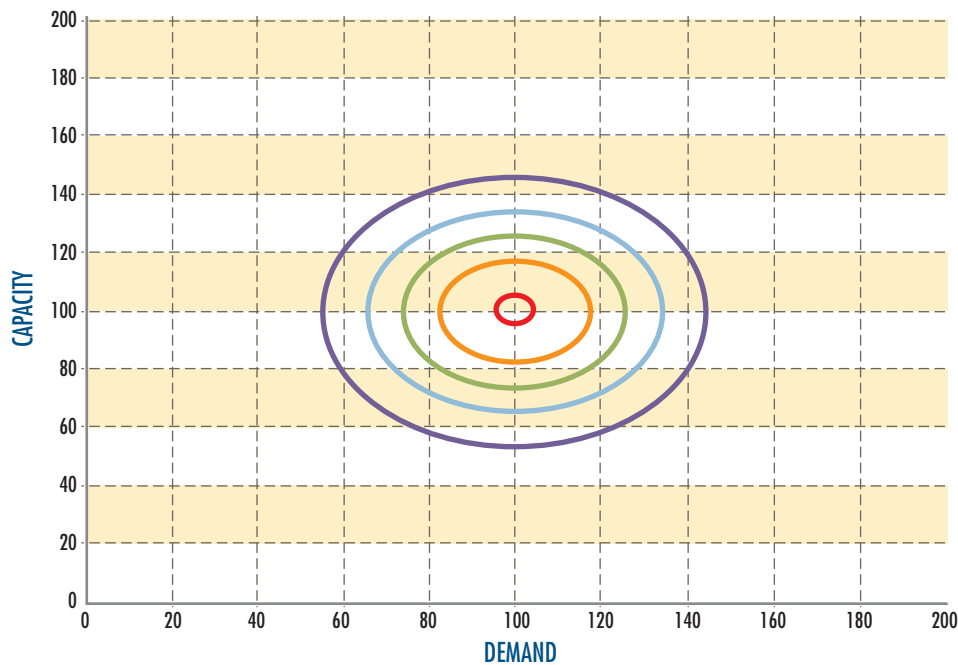

Figure 4-2:  
Infrastructure Demand and  
Capacity Dependency

Hence, to determine risk we have to estimate joint probability density function (PDF) of Equation 1, which represents a traditional systems reliability problem. The PDF has certain qualities which are easier to examine when Demand and Capacity are uncorrelated and independent variables.

Reliability techniques can be applied in engineering to compute the probability of failure based on a distribution of threats, or natural hazards, and a corresponding distribution of capacities to resist those threats. The probability of failure is determined based on the relative positions of the demand and capacity Probability Density Functions (PDFs) on a strength ordinate. Within the context of the definition of reliability, the probability of failure can be decreased by either: moving the relative positions of

the PDFs to decrease overlap (decrease the load, increase the strength) or by decreasing the dispersion, or When demand and capacity are uncorrelated and independent variables, Equation 1 is simplified into the expression for reliability:

$\sqrt{f}$  Equation

$$P_f = \int_{-\infty}^{\infty} \int_C^{\infty} f(C, D) dD dC \quad (2)$$

Where:  $f_D(D)$  is PDF of infrastructure Demand;

$F_C(D)$  is a cumulative density function (CDF) of infrastructure Capacity

In this case, it is possible to visualize the system Demand and Capacity as two separate functions as shown on Figure 4-3. This figure provides a comparison of two system Capacities (A and B) for a defined Demand. Based on Figure 4-3, System A is not only stronger but also more reliable since the probability of failure of System A is less than System B.

Figure 4-3:  
Demand and Capacity are  
Uncorrelated and Independent

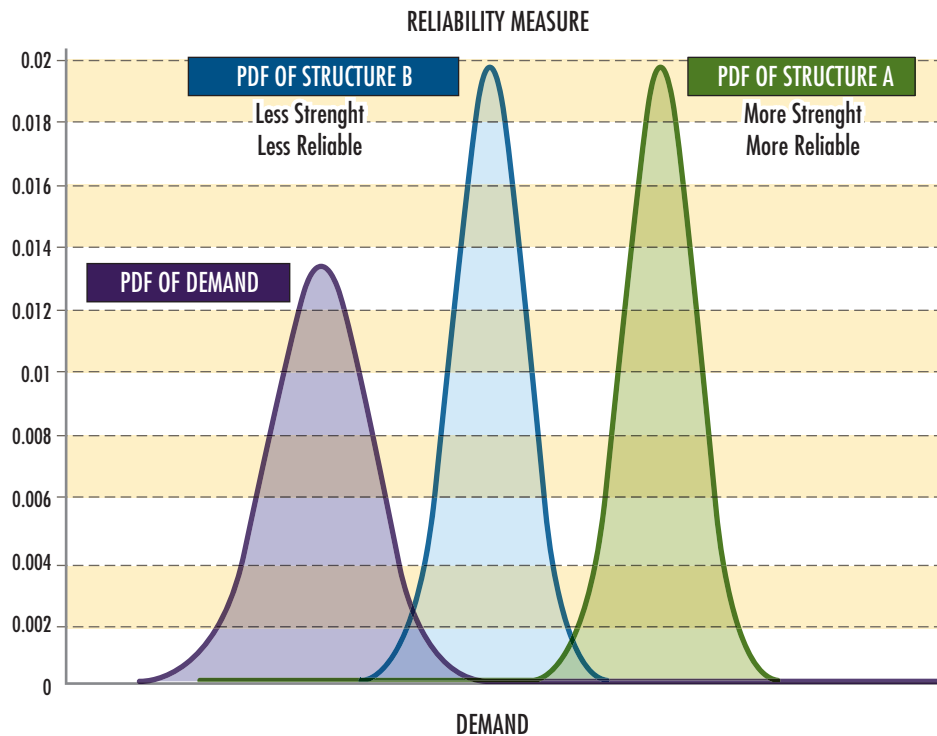

### 4.2.3 Resiliency and Robustness

ASCE recommends promoting sustainability and resiliency as an integral part of its infrastructure report card. In Ref [4] ASCE presents a qualitative description of resiliency in context of each infrastructure sector. However it falls short in providing clear definition of resiliency. It is implied that resiliency is measured as elapsed time from the destructive

incident until full operation of the infrastructure system is restored. Therefore, resiliency not only depends on the properties system (although it is unclear how) but it also depends on the system's operation and repair-time.

Another important quality of an infrastructure system is robustness, which is solely a property of the system. Robust infrastructure is insensitive to small deviations in assumed design parameters. The concept of robustness is illustrated on Figure 4-4. Despite System A and System B having the same Capacity values, System A is more robust than Structure B, since the probability of failure for System A is less than that of System B. We may also note that System A is more reliable than System B without having more Capacity (i.e., the area under the curve for A and B is the same).

A subset of robustness is *redundancy* which is related to the existence of multiple and redundant sub-systems. These sub-systems may provide temporary and quick alternate way for the system to work around the damaged area and remain operational until full Capacity is restored.



To calculate risk and reliability we must first estimate probability of failure given successful execution of a defined threat, and have an estimate of total consequence value. Unfortunately, realities of the 21st century dictate that threat cannot always be predictable, and consequences can also be intangible due to cascading or other effects. The main challenge of today's engineering community is to develop an analytical procedure to mitigate effects of all possible threat conditions. This is achieved through sustainability, resiliency, and robustness concepts.

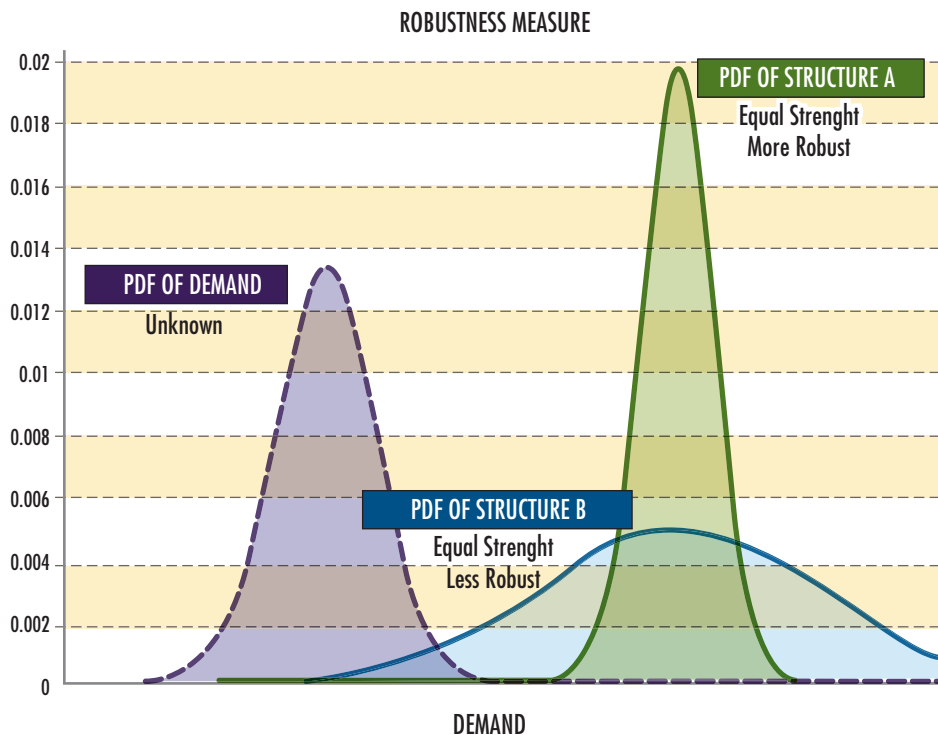

Figure 4-4:  
Illustration of Robustness

### 4.2.4 Protective Design of Robust Systems

Remarkably, there is little common ground regarding the definition of robustness. A quick look at the dictionary reveals five variations of the adjective with three of those five including the word “strong” or “strength.”

Remarkably, there is little common ground regarding the definition of robustness.

So, it is natural that engineers, when asked about the meaning of robustness, would reply with words like “strong,” “resilient,” and “redundant.” There is currently no direct guidance out of the United States building codes standards that link robustness with a quantifiable definition. Be that as it may, other engineering and scientific disciplines have

various specific definitions of robustness, and it is helpful to examine them here. Insight from outside of the structural engineering community combined with specific definitions of structural engineering metrics will lead to an adaptation to the definition of robustness and a novel way to evaluate infrastructure systems.

In November of 2005, the Joint Committee on Structural Safety (JCSS) and the International Association for Bridge and Structural Engineering (IABSE) working Commission 1 convened a workshop on the robustness of structures. The European establishment has shown itself to lead the Americans in the integration of reliability metrics into their building code, and it should come as no surprise that they are leading the discussion of structural robustness as well. At the conclusion of the conference it was agreed the robustness is the “product of several indicators,” many of which might be expected to be associated with robustness. The indicators identified include many of the aforementioned metrics: redundancy, ductility, variability of resistance, interdependency of failure modes, and joint performance, just to name a few.

Based on these conclusions it is evident that robustness is a complex metric not solely related to strength, but rather it is part of a system of indicators (one of which is strength), and that the quantification has to do with the structure’s sensitivity to stimulus, regardless of the magnitude of the stimulus.



In Protective Design, the threat is unpredictable because the nature of the threat is always changing, evolving, and (usually) increasing in frequency and magnitude (TSWG, 2004).

In Protective Design, the threat is unpredictable because the nature of the threat is always changing, evolving, and (usually) increasing in frequency and magnitude (TSWG, 2004). In this practice, it is difficult to predict any structure’s reliability given the great dispersion that is expected in the load scenario induced by the threat, though it is possible to determine and influence the dispersion of the



resistance function. Increasing the certainty in the structural resistance by decreasing the standard deviation of the capacity—regardless of the expected value of the resistance (or strength)—increases the reliability for a constant threat PDF, and it also decreases the sensitivity of the system response to loading stimuli. The physical outcome of a narrow PDF for resistance is that the reliability of the structure will likely be unaffected by small perturbations in loading. This outcome is consistent with the Eurocode definition of robustness as well as the expected behavior of robust systems in various scientific fields.

A common approach to estimate resiliency and robustness is based on introduction of damages into the system and determination how sensitive the system is to this damage (robustness) and how soon this system can recover (resiliency). Notable, these damages are almost universally related to damages due to a terrorist attack (i.e., a catastrophic event) and usually represented as an element removal (i.e., total destruction of the element). This approach requires enormous computational time as all damage scenarios as well as all response scenarios need to be determined and analyzed. This is a significant drawback of current approaches. Probabilistic techniques enable us to encompass all threats uniformly and as such will facilitate the design and improvement to infrastructure systems to withstand all threats, and natural hazards.



A common approach to estimate resiliency and robustness is based on introduction of damages into the system and determination how sensitive the system is to this damage (robustness) and how soon this system can recover (resiliency).

### 4.2.5 All Hazards Approach

The Fire Department of New York issued Terrorism and Disaster Preparedness strategy in 2007 [5], where it is strongly encouraged to “All-Hazard Preparedness.” The term all-hazard requires clarification to respond adequately to this challenge. How does one consider all hazards in the design and evaluation of our aging critical infrastructure? Table 4-1 provides examples of the assumptions made in the 20th century for the purposes of quantifying the effects of disasters are no longer accepted and are inconsistent with an all hazard approach.

In response to these shifts in our understanding of what a disaster is, the probabilistic concept of robustness provides a satisfying new approach, for it is a truly threat independent.

Table 4-1: Design Assumptions made in the 20th century that are inconsistent with the 21st century all-hazard approach.

20th Century Design Assumptions	21st Century Realities
A terrorist attack consists of a single event at a single site (e.g., Oklahoma City Bombing).	Sequential or concurrent attacks at a single or multiple sites (e.g., nearly simultaneous events at WTC1, WTC2, and the Pentagon on 9/11).
Only one type of hazard or threat is considered to occur during an event. Fires, explosions, hurricanes, and floods are considered separately (e.g., Hurricane Andrew).	Disasters often encompass multiple hazards or threats, such as flood and hurricane, explosion and fire, earthquake and tsunami. These combinations of factors need to be included in the design process. An example of this is Hurricane Katrina in which the effects of hurricane caused the levee failures which initiated catastrophic flooding. Another example is the impact of planes into WTC1 and WTC2 survived the plane impact, but failed catastrophically due to the subsequent airplane fuel fire.
The risk associated with natural disasters may be predicted based on past history.	The risk assumptions used for natural hazards no longer apply due to global warming, increased population growth, and other factors.
The risks associated with terrorist attacks are too rare to predict with accuracy.	There are ways to reasonably predict terrorist risk.
One major attack may be assumed to occur during the life of the facility.	If one major attack occurs at a site, another will occur. For example, the World Trade Center was attacked in 1993 and again in 2001.
Saving lives is all we can afford to do to protect a civilian domestic building. The design objective is to prevent collapse long enough to safely evacuate.	Saving lives is a minimum standard. In some cases it is economically justified to design for higher level of protection. For instance, major federal buildings are now designed to sustain 'moderate' damage in addition to resisting progressive collapse.
Our infrastructure needs to be designed to mitigate the effects of defined magnitudes and locations for hazards and threats which are quantifiable.	Our infrastructure needs to be designed to be able to resist hazards and threats which are evolving and complex.

## 4.2.6 Conclusions

In summary:

1. Today's realities requires our critical infrastructure in the 21st century to achieve resiliency through sustainability and system robustness in response to a complex evolving threat and hazard environment;
2. Our infrastructure needs to be designed to be able to resist hazards and threats which are evolving and complex;
3. Robustness represents an infrastructure's ability to absorb small failures (perturbations) without affecting the overall integrity, and can be measured as a standard deviation of the resistance probability density function;
4. Infrastructure robustness and resiliency represent interdependent qualities of system. Robust systems are inherently more resilient.

Probabilistic approach to robustness and resiliency encompass all threats. As such, robust and resilient design represent a true independence from threat.

5. Further research into the concepts of robustness and resiliency to explore how they may be used to evaluate our existing aging infrastructure and allocate our limited resources wisely for the demands of the 21st century.

Further research into the concepts of robustness and resiliency to explore how they may be used to evaluate our existing aging infrastructure and allocate our limited resources wisely for the demands of the 21st century.

### 4.2.7 References

Ang, A.H.S., Tang W.H., 1975, “Probability Concepts in Engineering Planning and Design-Vol. 2, Decision, Risk and Reliability,” John Wiley & Sons, Inc.

Ang, A.H.S., Tang W.H., 2007, “Probability Concepts in Engineering—Emphasis on Applications to Civil and Environmental Engineering,” John Wiley & Sons, Inc.

ASCE 2009, *America’s Infrastructure, Report Card*, American Society of Civil Engineers, 2009.

Benjamin, J.R., Cornell, C.A., 1970, “Probability, Statistics and Decision for Civil Engineers” McGraw-Hill, Inc., New York.

DHS, 2009, *National Infrastructure Protection Plan*. US Department of Homeland Security, 2009.

FDNY 2007, *Terrorism and Disaster Preparedness Strategy*, Fire Department of New York, 2007.

Kang, Z., 2005, *Robust Design Optimization of Structures under Uncertainties*, Dr. -Ing. Thesis, Institut für Statik und Dynamic der Luft- und Raumfahrkonstruktionen, Universität Stuttgart.

LVMPD, Silver Shield, 2009. *Nevada Critical Infrastructure Protection*, Las Vegas Municipal Police Department, 2009.

USA Patriot Act, 2001. *Uniting and Strengthening America by Providing Appropriate Tools Required to Intercept and Obstruct Terrorism Act*. Pub 1056.107.

## 4.3 Five Integrated Aspects of Aging Infrastructure Management: A Basis for Decision-Making at the United States Army Corps of Engineers (USACE)

*Richard W. Woolridge<sup>4</sup>, Jose E. Sanchez<sup>5</sup>, David P. Hale<sup>6</sup>, and G. Edward Gibson, P.E.<sup>7</sup>*

### 4.3.1 Introduction

The nation's physical infrastructure is an enormous asset that impacts the daily lives of virtually all citizens and whose reliability, safety, and security is a critical element in the nation's economy (GAO, 2008). One area of focus is the nation's navigable waterways. Forty-one states are served by commercially navigable waterways.

Closures more than doubled in the 1990's exceeding 120,000 hours system-wide in 1999. Unscheduled closures due to emergencies are much more disruptive to customers as they cannot be planned. A recent closure on the Ohio River resulted in an 80-hour delay that is estimated to have cost power utilities millions of dollars to reroute their coal supplies (TRB 2004). Therefore, the need to improve the nation's infrastructure is pervasive.

The American Society of Civil Engineers (ASCE), in its Report Card for America's Infrastructure, grades these waterways as a "D-" in 2009, where a "D" is defined as poor. Almost 50% of the 257 locks managed by the United States Army Corps of Engineers (USACE) are functionally obsolete with an expectation that 80% will be functionally obsolete by the year 2020. Waterway usage is increasing (ASCE, 2009).

Making decisions among alternatives to repair, replace, upgrade, and increase capacity of aging infrastructure is a significant issue. Construction funding levels at the USACE have declined from about \$3 billion in the 1970s to just over \$1 billion, not counting recent stimulus funding or post Katrina repairs. Inland waterways operations and maintenance funding levels have remained level at between \$400 million and \$500 million. This funding is allocated to a \$10 billion navigation

4 Management Information Systems doctoral student at The University of Alabama, Box 870208 Tuscaloosa, AL 35487-0208, phone 205-348-5525, fax 205-348-6327, email: rwoolrid@cba.ua.edu

5 Asset Manager at Headquarters of the U.S. Army Corps of Engineers

6 William White McDonald Family Distinguished Faculty Fellow; MIS Programs director; and director of The Aging Infrastructure Systems Center of Excellence at The University of Alabama, Box 870208 Tuscaloosa, AL 35487-0208, phone 205-348-5525, fax 205-348-6327, email: dhale@cba.ua.edu

7 Professor and the Garry Neil Drummond Endowed Chair in the Civil, Construction, and Environmental Engineering (CCE) Department at The University of Alabama, Box 870205 Tuscaloosa, AL 35487-0205, phone 205-348-6987, fax 205-348-0783, email: egibson@eng.ua.edu

infrastructure backlog for authorized and active projects, \$6 billion for inactive and deferred projects, \$1 billion for critical operations and maintenance backlog, \$1.9 billion of unfunded work to preserve asset value, improve security, and enable new missions for environmental restoration and stewardship (TRB 2004). Traditional funding to perform this work and the government's fiscal outlook are strained (GAO 2008).

Management of infrastructure and its associated funding decisions, called asset management in this paper, have not kept pace. The federal government's current process is based on business models and technologies dating from the 1950s. A high-risk area to the United States General Accountability Office (GAO) is an area that has greater vulnerability to waste, fraud, abuse, and mismanagement or major challenges associated with economics, efficiency, or effectiveness. In 2003, the GAO identified federal real property to be an area of high-risk and this area remains on the high-risk list as updated in 2007. The GAO found that assets (i.e., infrastructure) were no longer aligned with agency missions, nor were those assets responsive to the agencies' changing missions. The GAO also found that management of assets is exacerbated by competing stakeholder interests, legal and budget-related disincentives to businesslike outcomes, a need for better capital planning, and a lack of strategic focus. This GAO finding has led to action by the Congress, the administration, and government agencies (GAO 2003; GAO 2007), including an initiative at the USACE to reduce security risks to critical infrastructure and to improve reliability of water resources infrastructure using a risk-based asset management strategy (USACE 2006).

### 4.3.2 Asset Management at the USACE

The USACE serves the Armed Forces and the Nation by providing vital engineering services and capabilities in support of national interests across the full spectrum of operations, from peace to war. The scope of the research effort described in this paper is limited to the USACE Directorate of Civil Works which is a major component of the USACE. Civil Works programs are organized into eight business lines (Emergency Management, Environment Restoration and Stewardship, Flood Damage



Asset management is at the foundation of the United States Army Corps of Engineers (USACE) effort to manage the Nation's watershed systems for

the safety of its citizens, the continuation of the Nation's economic viability, commitment to the environment, and quality of life as it relates to water resources. The Asset Management Framework (AMF) will provide a structure for holistic, risk-based, analytically driven infrastructure decisions including investment strategies for maintenance, recapitalization, and new investment that improves reliability and minimizes risk. This approach embraces watershed systems and integrates all business lines to form a comprehensive overview of each watershed. This paper presents the underlying five aspects on which the AMF is constructed and being applied to other infrastructure systems. The five aspects detailed in the paper are: Purpose, Artifact, Action, Resource, and Mechanism.

**INFRASTRUCTURE TYPE:** Watershed systems

The USACE owns and manages a diverse and extensive portfolio of watershed infrastructure assets including over 43,000 structures, 285,000 tracts of land and 12,000 buildings. These assets range from 1,000 Coastal Structures and 600 Dams to 2,500 Recreational Areas, 250 Navigation Locks and Dams and 75 Hydropower facilities. The value of USACE water resource infrastructure assets rank among the top five of all Federal agencies.

Reduction, Hydropower, Navigation, Recreation, Regulatory, and Water supply) that are responsible for achievement of the USACE mission.

To achieve the proper management of this large infrastructure portfolio, and to achieve compliance with the asset management directives, the USACE published its Asset Management Plan. The plan described the Asset Management Framework (AMF) as a next step in providing consistency and transparency in asset management throughout the Civil Works business lines. The AMF is a decision framework involving the balancing of mission needs and risks and the condition and performance of its assets. A goal

is to exploit new technologies and leverage national, industrial, and intellectual capabilities and to commit to providing stewardship in the best interests of the taxpayers (USACE 2006). The AMF is grounded in the principles of the Federal Real Property Council (FRPC) established in response to Executive Order 13327. The FRPC's ten guiding principles, applicable to Federal real property asset management, are:

1. Support agency missions and strategic goals
2. Use public and commercial benchmarks and best practices
3. Employ life-cycle cost-benefit utilization
4. Promote full and appropriate utilization
5. Dispose of unneeded assets
6. Provide appropriate levels of investment
7. Accurately inventory and describe all assets
8. Employ balanced performance measures
9. Advance customer satisfaction
10. Provide for safe, secure, and healthy workplaces

Asset Management is at the foundation of the USACE's Civil Works Directorate's effort to manage the nation's watershed assets for the safety of citizens, the continuation of the Nation's economic viability, protection of the environment, and sustainment of quality of life. Asset management has always been a key priority within the Civil Works Directorate as it directs projects in four broad areas: water infrastructure, environmental management and restoration, response to natural and manmade disasters, and engineering and technical services to the Army, Department of Defense, and other Federal agencies. Asset management involves the allocation of limited resources over time to affect asset management decisions in a way that maximizes value. Asset management is a complex process of feasibility and value, trading off, and balancing

competing needs for the scarce budget resources. Asset management decisions include:

- **Investigate**
  - Studies to determine which, if any, other decision should be made for an asset or a watershed
  - For example, a study of a watershed to determine whether an upgrade to 1200 foot long lock chambers are justified
- **Develop**
  - Creation of a new asset or to significantly change the level of service for an asset
  - For example, construction of a new lock and dam, or addition of lock chambers to an existing lock and dam
- **Operate**
  - Utilization of an existing asset for a purpose at a given level of service
  - For example, allocation of the staff and other resources needed to operate a specific lock and dam efficiently
- **Maintain**
  - Performance of some maintenance action on an asset
  - For example, replacement of gates on a specific lock chamber
- **Decommission**
  - Discontinue use and remove an asset from inventory
  - For example, drainage of a pool and demolition of the dam structure, or transfer of ownership to another organization

#### 4.3.2.1 Asset Management Framework (AMF)

Early in 2007, the AMF team was established, and the team defined its charter as the development of a conceptual framework whose purpose is to create an integrated national plan for assessment of the USACE's watershed infrastructure assets and to provide investment strategies for maintenance, recapitalization and new investment that improves reliability and minimizes risk. Thus, the AMF integrates preservation and risk mitigation initiatives with budget and resource allocation processes to provide a uniform vision for performance and service throughout all its business lines, while incorporating a lifecycle investment strategy. The AMF team has a breadth of experience in asset management, risk management, preservation, and budgeting. A steering team was established to provide additional direction for the AMF team and add diversity of thought from multiple levels and disciplines within the organization. The

Aging Infrastructure Center of Excellence (AISCE) at The University of Alabama was a charter member of the AMF team. The AISCE brings to the team cross infrastructure systems experience and asset management project expertise. AISCE team members have home disciplines in engineering, enterprise integration, information systems, risk management, project management, economics, physical sciences, and analytic modeling.

The AMF focuses on assets, systems of assets, performance and risk. It provides the foundation for efficient resource allocation and preservation programming decisions, which deliver value to the system and overall watershed user satisfaction. Program quality and system performance will improve through use of this performance- and risk-based asset management system. Investment decisions are supported using portfolio analysis. Portfolio analysis is enabled with four sets of parameters that are aligned as shown 4-5. The aligned components include: Mission, Measures, Organization, and Asset Hierarchy.

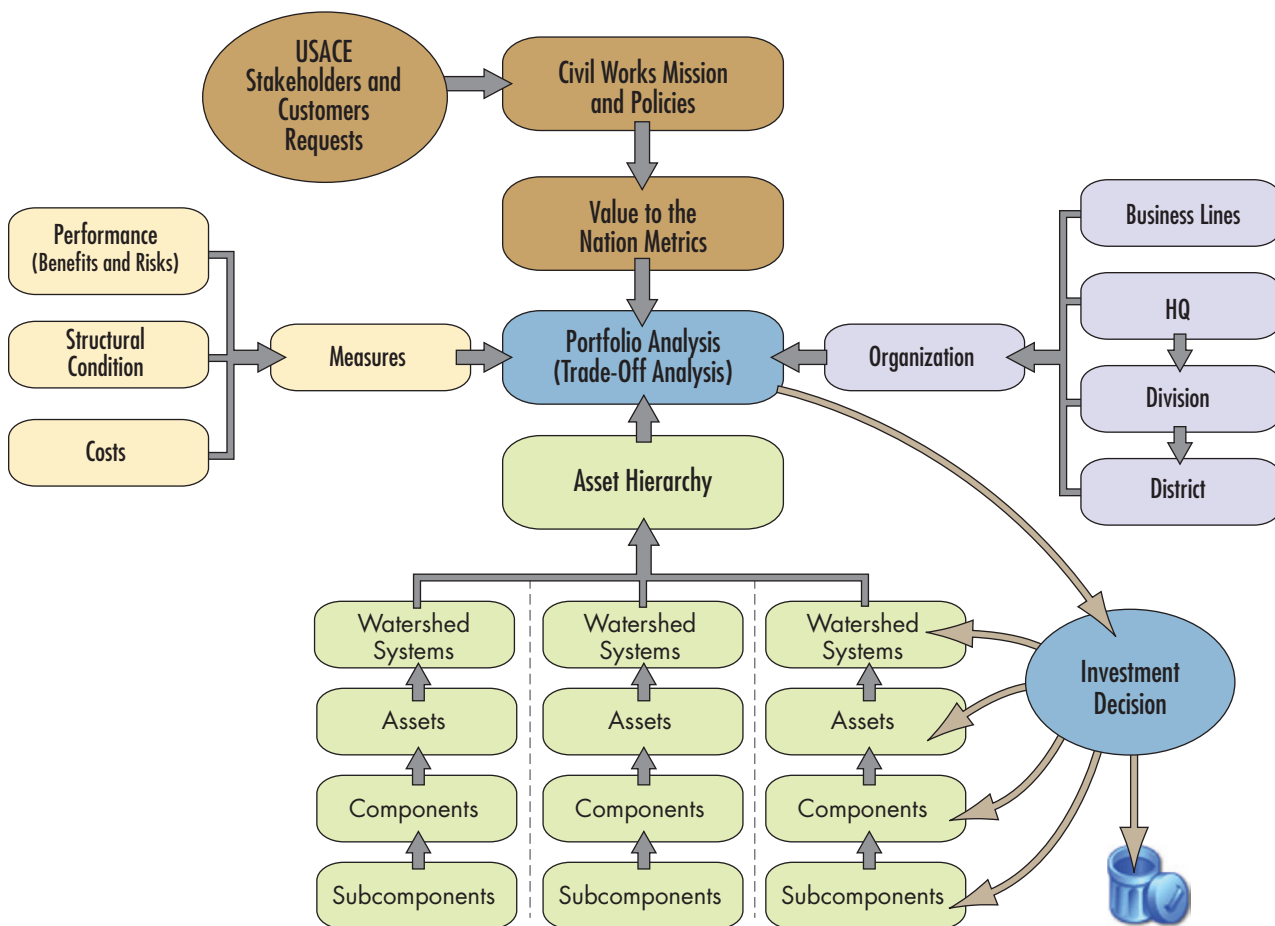

Figure 4-5: AMF Component Structure



The AMF provides a USACE Civil-Works enterprise perspective, by incorporating a series of priorities from multiple internal and external stakeholders, and by encompassing all levels within the USACE organization. The AMF provides the architecture for systematic and comprehensive decision support for the preservation, recapitalization, maintenance, new development, and decommissioning of USACE assets. It maintains current (baseline) assessments and desired (e.g., target) levels of service and funding. The AMF uses a principle-based approach for development and deployment to ensure that it is aligned with the intent of stakeholders. In order to meet critical requirements the AMF must:

- **Provide Context-Specific Recommendation (Decision) Support**— enabling:
  - Decisions justified by value
  - Analytics driven by preservation strategy
  - Expenditures driven by budget process
  - Adaptation of framework and decision approach driven by results
- **Provide Roll-Up Reporting and Drill-Down Analysis**— through structures that enable metric and measure roll-up reporting and drill-down analysis
- **Enable Process Transparency**— enable stakeholders to understand how the metrics, structure, and process collectively produce results
- **Enable Responsibility and Accountability Alignment**— de-conflict the organization, watersheds, assets, decisions, and perspectives structures to ensure responsibility and accountability
- **Enable Comparability**— create common structures, processes and analytics for business lines and operating units to enable cross-business line and cross-operating unit comparability
- **Provide Probabilistic and Deterministic Decision Support**— augment traditional deterministic modeling with probabilistic decision support approaches
- **Provide Temporal Functionality**— maintain historical trends and future forecasts
- **Enable Standard Repeatable Processes**— comprehensive planning and execution provides confidence in decisions
- **Enable System Focus**— focus on asset system effects critical to achieving value and avoiding risks and interface with other systems for within asset component analysis

- **Enable Business Line Focus**— emphasize business line perspective over a functional approach
- **Enable Multi-Purpose Asset Evaluation**— assets and systems of assets provide service to more than one business line
- **Enable Decisions Based on Conditions, Value, and Risks**— incorporate tools for decisions based on current / required condition gaps and the implications to both value and risks
- **Be Robust and Resilient**— AMF is extendable over time with the ability to adapt as new external AMF requirements are identified
- **Be Phase Deployable**— enable value to be obtained from the AMF while deploying it in phases

#### 4.3.2.2 Five Aspects of AMF Model

The model, when applied to the USACE, results in the AMF shown in 4-6. “Portfolio Analysis” describes how Resources are allocated to Investment Decisions. “Investment Decision” represents the choices made regarding asset investigation, development, operation, maintenance, and decommissioning. “Organization” represents Mechanism (i.e., people, process, tools, and data) necessary to make and execute those Investment Decisions. “Asset Hierarchy” identifies the systems, assets, components, and sub-components required to achieve Purposes. “Value to the Nation Metrics” and “Measures” identify the Purposes for which the assets are utilized.



The model on which the AMF is based suggests that asset management decisions are made in a system requiring a holistic approach addressing five aspects: purpose, artifact, action, resource and mechanism.

The five aspects approach integrates the complex and dynamic interaction associated with asset management decisions. In practice at the USACE, the assets to be managed (i.e., artifacts) occur at multiple levels of detail including systems that may not be considered an asset per se and lowest-level

sub-components that may be considered too small to be managed as an asset. Each of these assets has multiple purposes (e.g., a lock and dam is used for water supply, navigation, safety, and security missions) causing the level of service and condition of the asset to be different based on purpose. The organization, at different levels (e.g., headquarters, divisions, and districts), has different responsibilities associated with deciding which actions (e.g., investigate, develop, operate, maintain, and decommission) should be performed on assets and then executing those authorized actions.

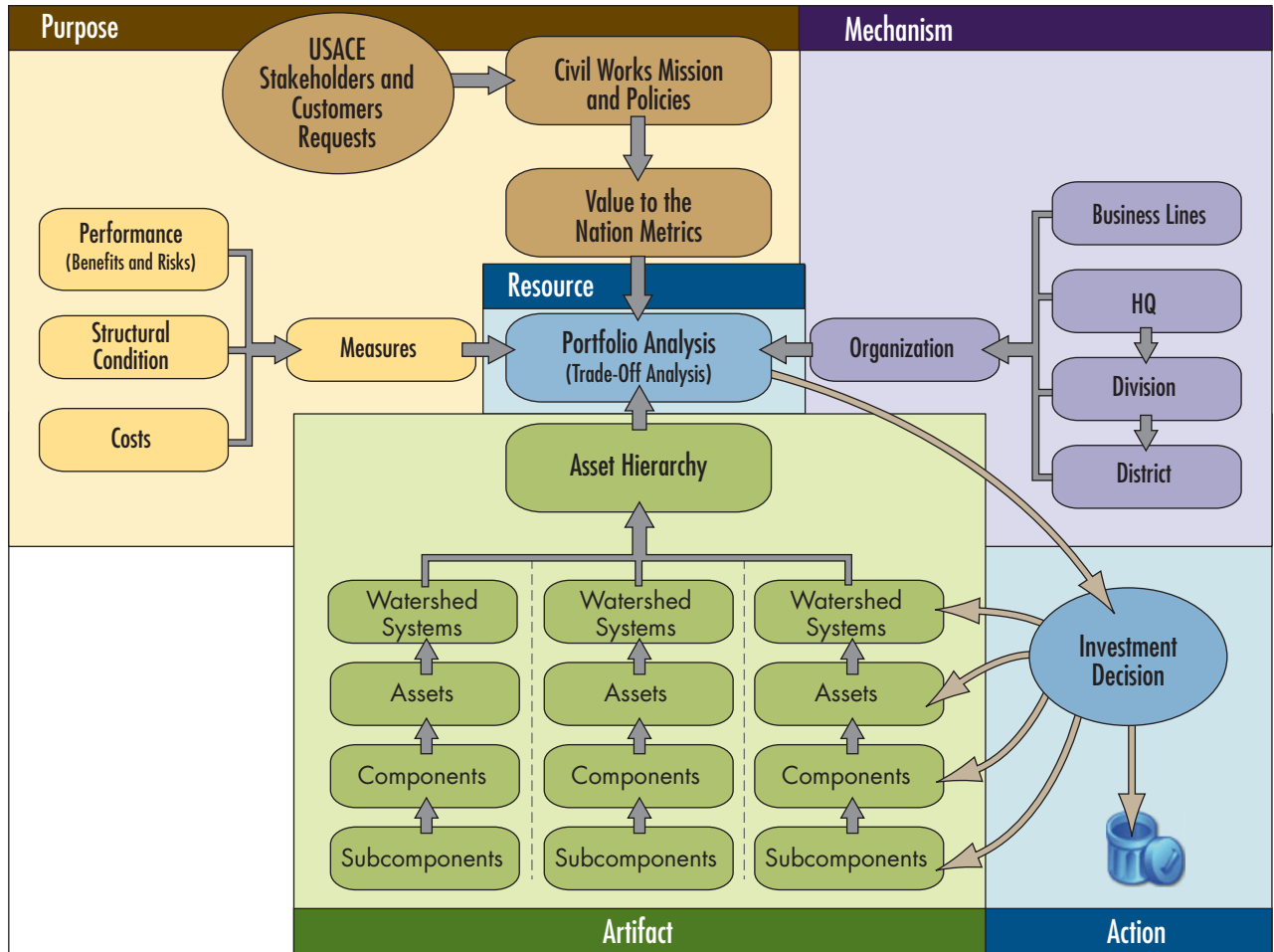

Figure 4-6: Five Aspects of Asset Management

The organizational units must be assessed so that actions can be taken regarding organization's capability (e.g., maintaining the service fleet required to maintain locks and dams), as well as actions regarding the physical infrastructure. Resource allocation therefore includes organizational capability investments as well as asset management investments. The dynamics and complexity associated with these aspect interactions and systemic feedback may be best described using Complex Adaptive Systems (CAS) as the theoretical lens. A structural model that enables interaction between the five aspects is a necessary component of a successful asset management approach.

#### 4.3.2.3 Aspect Interaction

An artifact provides a focus from which all other aspects are specified. An artifact may be specified at varying levels of detail. While it may seem that the only focus within the context of asset management would be an asset, it is often necessary to focus on different levels of detail from the

highest-level system to the lowest-level sub-component. The varying levels of detail form a hierarchy of artifacts as shown in 4-7. The need to focus on different levels of detail, as well as the specification of that detail, is driven by the purpose for which the artifact is utilized.

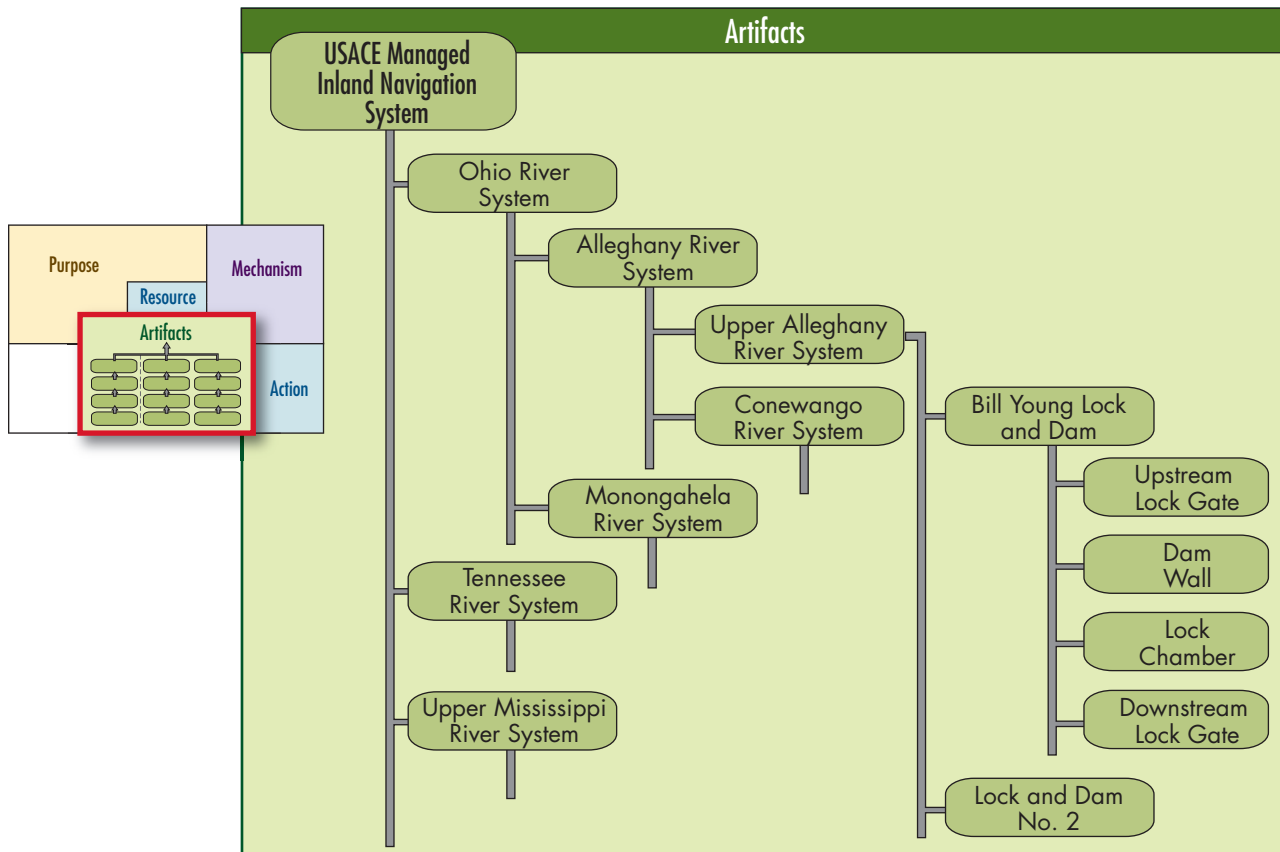

Figure 4-7: Hierarchy of Artifacts

Purpose identifies a perspective when viewing an artifact.

Purpose identifies a perspective when viewing an artifact. The USACE maintains assets to fulfill a number of purposes broadly identified by eight business lines: Navigation, Flood Damage Reduction, Environmental Restoration and Stewardship, Hydropower, Recreation, Emergency Management, Water Supply, and Regulatory. In addition to these broad purposes, the USACE has other purposes that include maintaining safe and secure facilities. Purposes, like artifacts, have differing levels of detail as shown in Figure 4-8.

As an illustration, the Bill Young Lock and Dam, part of the Upper Allegheny River System, Ohio, is an example of an artifact that serves multiple purposes and the view of the artifact changes when viewed from

the differing perspectives of purpose. Figure 4-7 includes a view of the Bill Young Lock and Dam with a perspective of navigation that includes components of upstream gate, dam wall, lock chamber, and downstream gate. This same artifact fulfills a purpose of a source of municipal and industrial water supply and this focus limits the components to the dam wall and upstream gate as the need for this purpose is to create a pool from which the water can be drawn.

When viewed from the perspective of safety, the components include signs, handrails, and safety equipment and when viewed from the perspective of security the components may include components such as fencing, lighting, and cameras. The perspective of purpose permits the determination of a condition required in order for the artifact to fulfill its purpose. For example, a secure lock and dam may be one where fencing, lighting, and cameras are present, appropriately positioned, and operational along with the requisite well-trained security personnel. Action may be required to rectify the situation when it is determined that the artifact does not meet the condition required to fulfill a purpose.

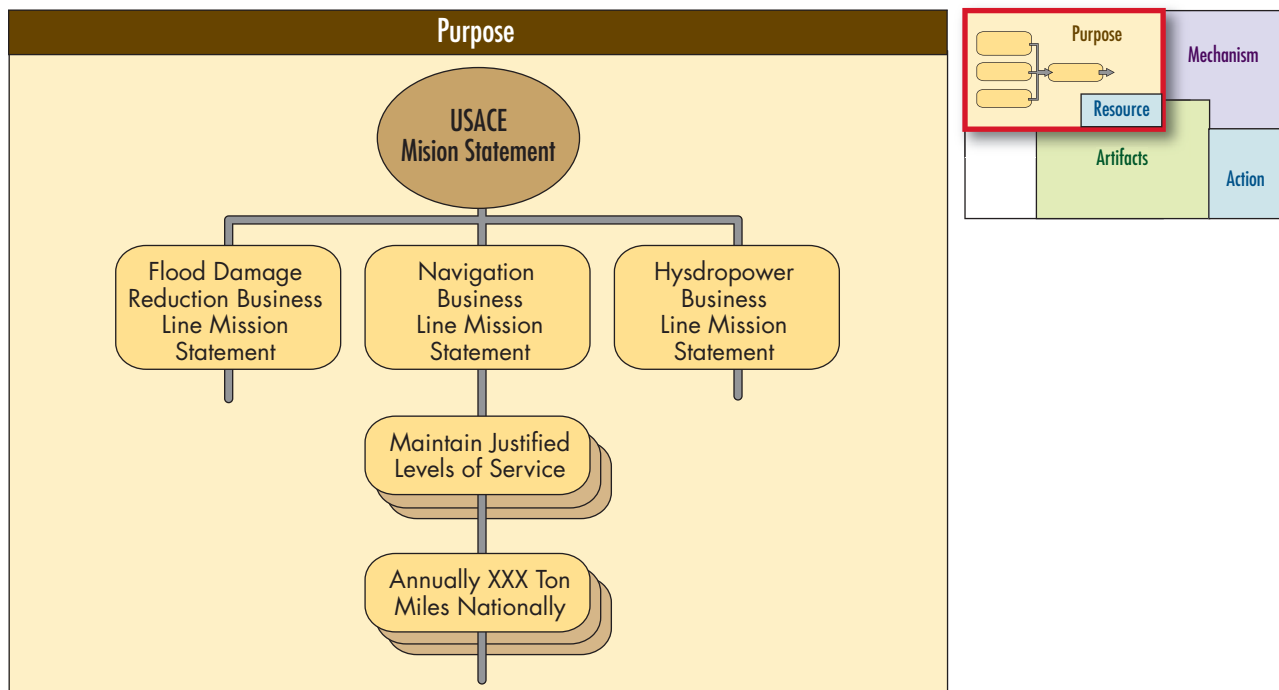

Figure 4-8: Hierarchy of Purposes

The action of “**develop**” at the USACE include actions such as the construction of new artifacts (e.g., build a new dam) or the replacement of existing artifacts (e.g., demolish and rebuild an unsafe dam).

The action of “**operate**” provides staffing and other resources needed to utilize an artifact for a purpose (e.g., operate a lock and dam to permit the passage of barge traffic) since without operation a lock and dam cannot fulfill its purpose of navigation. The action of “maintain” is a category that includes a broad array of activities from ordinary ongoing maintenance and minor repairs to major repairs and overhauls.

**Maintenance** is an activity that permits the artifact to maintain a condition (e.g., ongoing maintenance and minor repairs) as well as change the condition of the artifact from non-functional to functional or from unsafe to safe, through activities such as major repairs and overhauls.

The action of “**decommission**” removes an artifact from utilization for a purpose. The action of “decommission” may simply mean that the artifact will be placed in an unused state, or disposed by selling to a third party, or that the artifact will be demolished. The performance of any action requires the expenditure of resources.

Resources provide the means to perform actions. The most commonly identified resource is money. Money is exchanged for specific things necessary to perform some action. For example, the USACE exchanges (i.e., spends) the money in its budget for electrical power, salaries, supplies, equipment, and other items in order to operate and maintain a lock and dam. Resources by definition are consumables; that is to say that the utilization of a resource for some action means that the resource is not available for other actions in the future. However, resources may be exchanged for mechanisms.



Mechanisms, like resources, are necessary to perform actions.

Mechanisms are distinguished from resources in that the utilization of a mechanism does not consume the mechanism, thus leaving it available to perform other actions at a later time.

Mechanisms, like resources, are necessary to perform actions. Mechanisms are distinguished from resources in that the utilization of a mechanism does not consume the mechanism, thus leaving it available to perform other actions at a later time. The difference between resource and mechanism may be illustrated through an example. Assume that a hinge on a lock and dam gate is broken and requires replacement. The new hinge is a resource that once mounted on the gate is no longer available for other uses. However, the mounting of the hinge may require a significant number of mechanisms, such as: a crane to lift the gate, cutting

torches to remove the broken hinge, welding equipment to mount the new hinge, and some number of people that have the skills and abilities to perform the task. Each of the afore-mentioned mechanisms are not resources because once the task is completed, they are available to replace the hinges on other gates or for other tasks. The list of mechanisms however suggests other resources that are required besides the new hinge. For example, the crane requires fuel, the cutting torch requires a different kind of fuel, the welding equipment requires welding rods, and the people require wages and all of these requirements identify resources necessary to replace the broken hinge.

Extending the previous example provides an illustration of how the five aspects interact. The previous paragraph describes the interaction of resources and mechanisms to perform an action of replacing a broken hinge on a lock and dam gate. To summarize what was described in terms of the five aspects, the artifact in focus is a lock and dam gate hinge, the action was replace, or maintain using the category described in the action paragraph, the resources were listed and include fuel of various kinds, welding rods, salaries, and a new hinge, the mechanisms were listed as crane, cutting torch, welding equipment, and people with certain skills. The purpose for performing the maintenance action on the lock and dam artifact was navigation, or more specifically, the passing of barge traffic is the purpose of the lock and dam and it could not perform its purpose with a broken hinge. The purpose provides the reason for maintaining the lock and dam. The broken hinge places the lock and dam in a condition that prevents it from fulfilling its purpose. Therefore, a maintenance action of replacing the hinge is necessary, but that action cannot be performed without the mechanisms that provide the capability to perform the action. However, the mechanisms cannot perform the action without the requisite resources. All aspects of the model are thus required for asset management.

### 4.3.3 Detailed Decomposition of the Five AMF Aspects

The Five Aspect AMF model provides a holistic management decisions support approach. Using the center box of 4-6 as a starting point, Portfolio Analysis describes how Resources are allocated to the four potential investment types shown in Figure 4-13 (e.g., Replace Hinge, Capability to Replace Hinge, Decide to Replace Hinge, and Capability to Decide to Replace Hinge). Organization represents Mechanism (i.e., people, process, tools, and data) necessary to perform physical actions (e.g., Replace Hinge) and informational actions (e.g., Decide to Replace Hinge) as shown in Figure 4-8. Investment Decision represents the physical



The Five Aspect AMF model provides a holistic management decisions support approach.

and informational Actions as described in Figure 4-11. Asset Hierarchy identifies the required conditions of systems, assets, components, and sub-components to achieve the purposes as shown in Figure 4-10 (e.g., Required Condition: At least one lock fully operational at all times and Current Condition: Stressed hinge on one lock chamber). Value to the Nation and Measures identify value and risk Purposes at the goal, metric, and measure levels of detail as shown in Figure 4-9 (e.g., Value Goal: Maintain justified level of service, Metric: Ton Miles, Measure: Achieve XX ton miles nationally). All of these aspects of asset management, as described in the AMF, must be integrated into an implementation plan. This section provides a more detailed explanation of the 5 AMF Aspects that enables the aspect model to be replicated in for other infrastructure systems.

#### 4.3.3.1 Purpose

Purpose identifies the emergent goals and values of the achieving the goals for stakeholders. These stakeholders include the infrastructure steward, general public, governmental bodies, and users. Thus purpose



Purpose identifies the emergent goals and values of the achieving the goals for stakeholders. Purpose changes over time as different demands are placed on the infrastructure system.

exists for multiple stakeholders at multiple levels of abstraction and includes positive and negative consequences. Moreover purpose changes over time as different demands are placed on the infrastructure system. In waterway systems, like other infrastructure systems, the risk associated with not achieving a level of service results in lower quality of life, loss of property and / or loss of life. Goals are used to establish metrics, which provide a level of comparison among operating units (in the USACE, these are among business lines and organizational level).

For example, the USACE Water Navigation business line has a goal to maintain navigable waterways. Its metric is a cross-organizational index (e.g., amount of tonnage moved). A metric has some number of measures which have specific algorithms and procedures used to populate and calculate its parent metric. The corollary to this value is risk. In this example, the risk of not achieving the level of service goes beyond just not moving the tonnage. For example, lower quality of life due to scarcity of the goods, extra burden placed on other infrastructure systems (i.e., higher road/rail traffic), higher prices, and the cascading secondary effects caused by not achieving the goal. Figure 4-9 illustrates the structure of purpose using the above example.





Figure 4-9: Goals, Metrics, and Measures for Value and Risks

#### 4.3.3.2 Artifact

The relationship between purpose and artifact is that of required condition. The allocation of measures to organizational units causes them to assess the condition of their assets that are necessary to achieve those measures. For example, if District A must use their locks to pass barges in order to achieve the navigation measure of 100,000 ton miles, then the lock must be operational and reliable. The district will then set a threshold condition measure for the lock that must be maintained to reliably meet that goal. That threshold condition is said to be the required condition of the lock. An inspection of the lock will reveal a current condition for the lock. Should there be a gap between the required condition and the current condition, or should there be an expectation that there will be gap, then the lock may be a candidate for some maintenance action.

Each artifact is usually associated with more than one purpose and the artifact is composed based on the purpose. For example, the purpose of the lock for barge traffic causes the lock to be composed of a set of gates, lock chamber, and other components. Given that one purpose for the lock is safety, then the lock will be composed of a set of signs, handrails, and safety equipment. The required and current condition of the lock will vary based on purpose and that any gaps in condition are purpose dependent. For example, a lock whose condition is sufficient to permit barge traffic may not be safe for those who operate it. An illustration of aspects of artifact can be found in Figure 4-10.

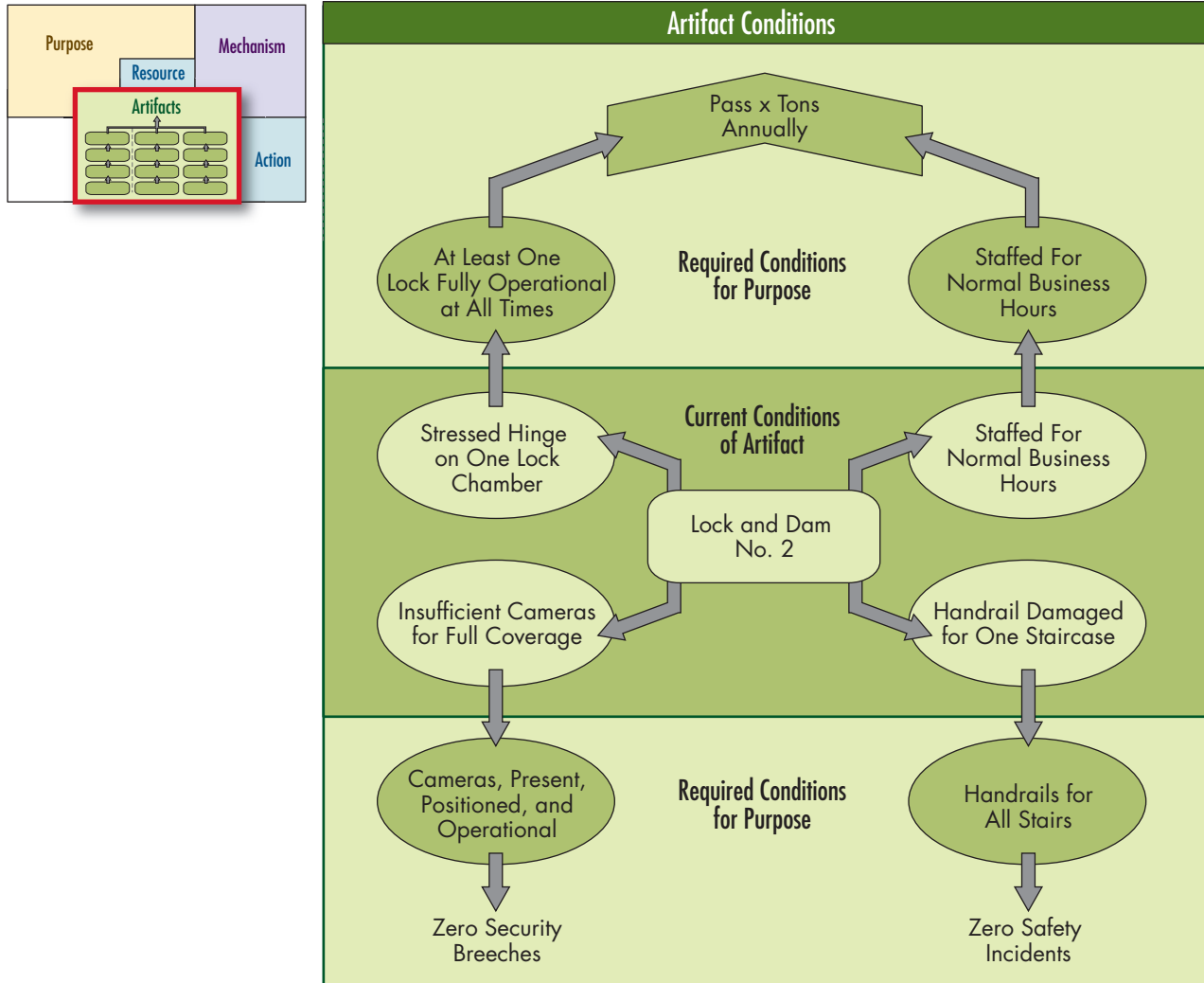

Figure 4-10: Artifact Conditions for Purpose

#### 4.3.3.3 Action

The identification of gaps between required and current condition of some artifact for some purpose identifies the need for some action to close the gap. The actions identified for asset management at the USACE can be categorized into four types: develop, operate, maintain, and decommission. These categories were previously described. In addition to the categories of actions, there are two aspects. The first kind of action is the most commonly thought of action, which is physical action. The lock gate hinge must be replaced for the lock to meet its required condition of operational. However, there is another kind of action that is critical to asset management, which is the informational action of deciding that the hinge needs to be replaced. A great deal of effort is required to make

unambiguous, transparent, and repeatable decisions and for this reason, the action of deciding is an important part of the model. An illustration of aspects of artifact can be found in Figure 4-11.

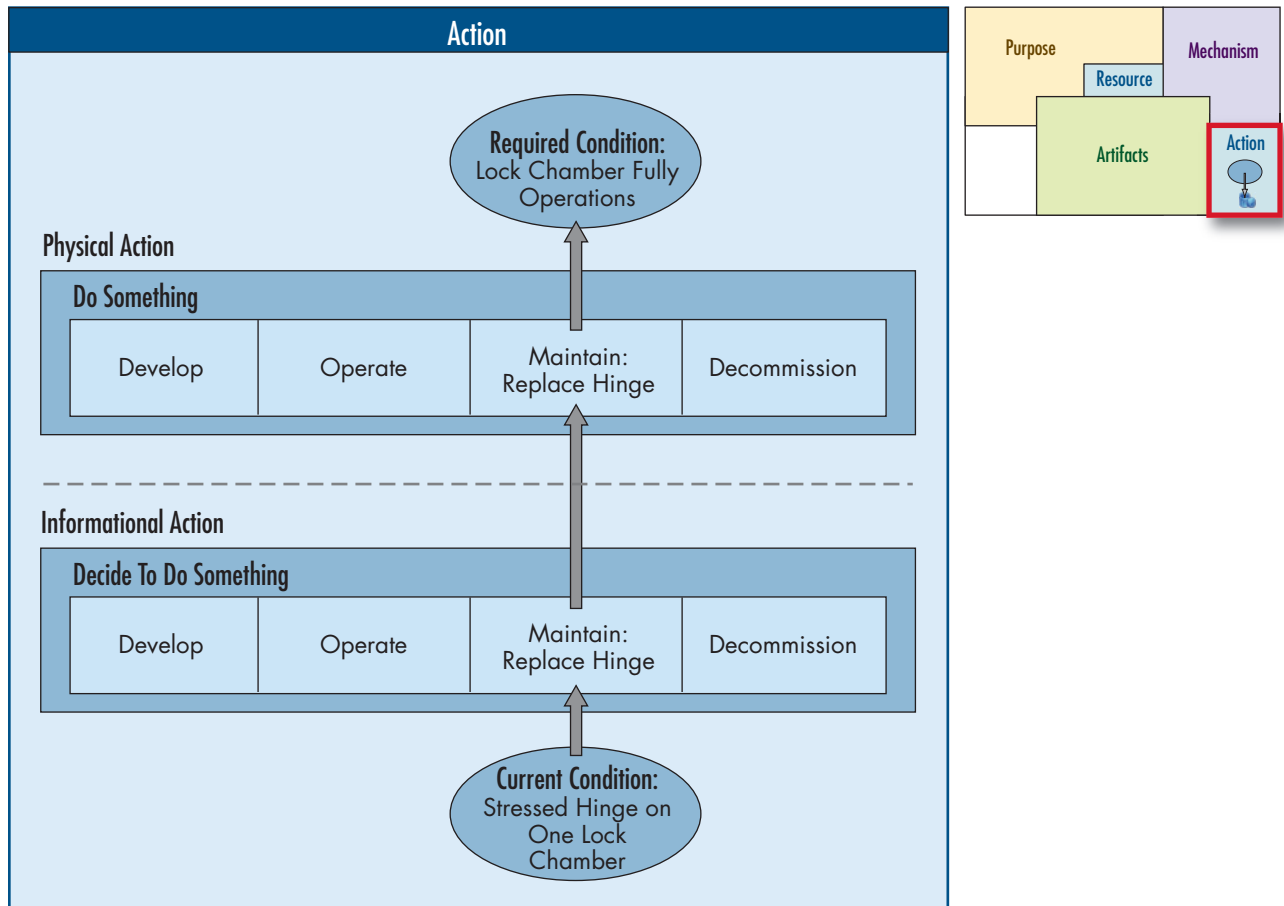

Figure 4-11: Informational and Physical Actions

#### 4.3.3.4 Mechanism

For example, the utilization of a hammer, a tool, does not preclude utilizing it again later for some other purpose, however, the use of a nail, a resource, does preclude its later use. More formally, a mechanism is the capability of transforming an artifact from its current condition to some desired condition given some set of resources.

The physical example has already been discussed, so the focus here will be on decision capability. The decision capability is dependent upon people, process, tools, and data. The ability of an engineer to decide that some lock gate hinge is stressed and should be replaced before it fails and unexpectedly closes the lock to barge traffic is dependent

The performance of an action cannot be accomplished without mechanism. As previously described, a mechanism includes the people, processes, tools, and in the case of informational actions, data, as shown in Figure 4-12. Mechanisms are distinguished from resources in that the utilization of a mechanism does not consume the mechanism, thus leaving it available to perform other actions at a later time.

upon some data that must be gathered. The engineer is then dependent upon some set of tools such as software and mathematical models to determine that the data does provide evidence that the hinge is stressed. The engineer must use a process for making the decision so that other people can be confident that the decision that the hinge is stressed is not just a subjective judgment that cannot easily be compared with other decisions by other engineers. Many of the decisions necessary for asset management at the USACE are highly complex and require significant capabilities to make decisions that are unambiguous, transparent, and repeatable.

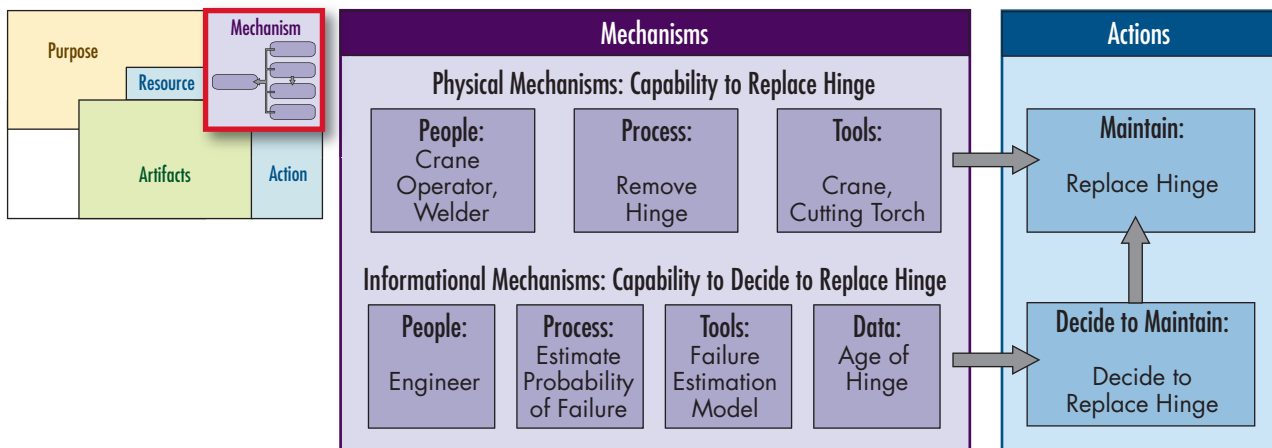

Figure 4-12: Mechanism's People, Process, Tools, and Data

#### 4.3.3.5 Resource

As shown in Figure 4-13, the budget may be allocated for four different kinds of uses. Budget may be allocated to perform some physical action (e.g., **Replace Hinge**) that can be outsourced to a vendor, or performed in house. If the decision is made to perform the physical action in house, then at some point the organization had to have invested in the mechanisms that give it the capability of performing the physical action (e.g., **Capability to Replace Hinge**), such as buying equipment, hiring operators, obtaining training or relative experience for employees, etc.

Informational actions also require a budget allocation. The organization could outsource the lock inspection and depend upon advice from the consultant to decide to take some physical action (e.g., **Decide to Replace Hinge**), or the organization could send out one of their own

engineers to perform the required inspection and analysis. If the decision is to be made in house, then at some point the organization had to have invested in the mechanisms that give it the capability to effectively and efficiently make the decision (e.g., **Capability to Decide to Replace Hinge**), such as development of the analytic models and software that aids the trained engineer in the decision. Since all four kinds of uses are common at the USACE, the resource management process must enable the balancing of different kinds of investments.

The performance of an action cannot be accomplished without resources. The most commonly identified resource is money that is then exchanged for other resources, or mechanisms. The aspect of resource for asset management at the USACE involves the allocation of a budget.

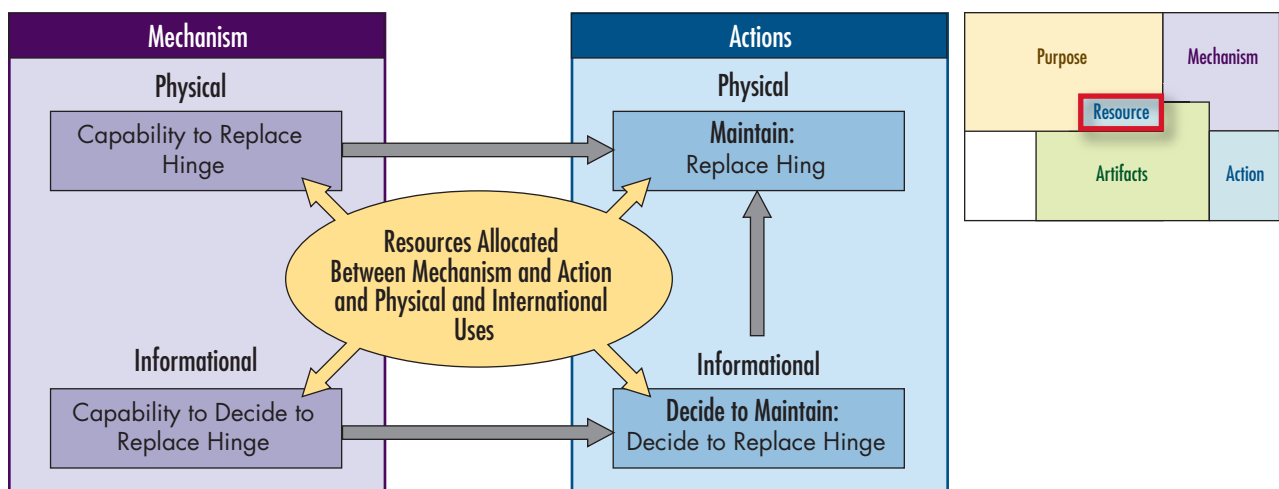

Figure 4-13: Resources for Mechanism, Action, Physical, and Informational

#### 4.3.4 Combining top-down and bottom-up Implementation

An asset management implementation plan must coordinate the five aspects in order to achieve the goals of consistency and transparency in asset management decisions. This coordination includes:

- Governance
- Inventory
- Condition
- Choice
- Feedback

The basis of governance is established using a top down approach. The value and risks against which performance will be measured are identified in a top-down fashion beginning with goals, metrics, and measures

(e.g., Value Goal: Maintain justified level of service, Metric: Ton Miles, Measure: Achieve XX ton miles nationally). Value and risks are identified at various levels including the national, state, and local levels. For example, the “Achieve XX Ton Miles Nationally” is allocated such that a portion of the ton miles goal is allocated to each USACE Division and then the Divisional ton miles goal is allocated to each of the Division’s Districts. While the ability to drill-down and roll-up measures at the lowest-level to the highest-level are of great importance, local level purposes may not rollup even though they will be important to the governance process. For example, the closure of a lock and dam may impact a local business that impacts local employment prospects. The top-down approach results in assignment of measure values to the asset inventory (i.e., at the system, asset, component, and sub-component levels).



The basis of inventory is established using both a top-down and bottom-up approach. Inventory includes the asset inventory, as well as the mechanisms required to perform asset actions and the mechanisms required to decide what asset actions to take.

The basis of inventory is established using both a top-down and bottom-up approach. Inventory includes the asset inventory, as well as the mechanisms required to perform asset actions and the mechanisms required to decide what asset actions to take. A top-down inventory of asset inventory consists of identifying the systems, assets, components, and sub-components needed to achieve each purpose, as shown in Figure 4-7. Also, a bottom-up approach identifies all assets in the inventory to ensure all assets are appropriately assigned their purposes thus refining the top-down inventory. A top-down inventory of mechanisms, both physical and informational, is performed based on the actions that must be performed in order to achieve purposes. For example, the tools, equipment, and buildings used to maintain the locks and dams, as well as the models and data used to assess lock and dam conditions. The bottom-up inventory is also performed to ensure all mechanisms have been identified.

The basis of condition is established in a top-down fashion for required condition and in a bottom-up fashion for current condition. The identification of required and current condition is performed for everything in the inventory (for examples see Figure 4-10), the asset inventory as well as the mechanism inventory. Required condition identification results from the conversion of measures to estimates of required condition that must be maintained in order for the inventory of assets to achieve their assigned measures.

For example, the required condition that a lock chamber must be operational at all times may suggest that the condition of the lock and dam must be at least an 80 out of a 100 point scale. Required condition for

mechanisms are also based on previously identified measures such as costs limits to perform actions, required level of confidence in decisions, and others. Current condition is established for each asset and mechanism in a bottom-up fashion based on an assessment of the asset.

The basis of choice is established in a bottom-up fashion to identify candidates and in a top-down fashion to identify actions to be executed. Candidates are determined based on a gap between required condition and current condition for assets and mechanisms (e.g., identification of the stressed hinge on the lock and dam). The resources needed to perform the actions are estimated (e.g., estimation that replacing the hinge will cost \$Y). Given funding levels, actions to be executed are chosen that appropriately balance investments in asset actions, asset choices, mechanism actions, and mechanism choices using a top-down approach that achieves asset purposes and provides the organization with future required capabilities (e.g., choose to replace hinge in next fiscal year along with many other projects and choosing not to perform other projects).



The basis of choice is established in a bottom-up fashion to identify candidates and in a top-down fashion to identify actions to be executed. Candidates are determined based on a gap between required condition and current condition for assets and mechanisms.

The basis of feedback is a comparison. Purpose feedback compares actual measures against assigned measures (e.g., did the lock and dam pass xx tons of freight last year?). Artifact feedback compares required condition against current condition (e.g., was at least one chamber operational at all times during the past year?). Action feedback compares condition to be achieved against post-action condition (e.g., was the hinge replacement project completed and is the gate now operational?). Mechanism feedback compares estimated capability to perform some action against actual capability (e.g., the plan was to replace the hinge in house, was any of the work outsourced?). Resource feedback compares estimated costs against actual costs (e.g., was there a budget variance on the hinge replacement project?).

All feedback is used to judge past performance, reevaluate measures, reassess required conditions, and set priorities for future actions. The implementation of feedback transforms the AMF from a static model to the kind of dynamic model needed to achieve future asset management goals.

### 4.3.5 Application of Five Aspects to Other Infrastructures

The USACE AMF was developed based on this five aspect model and validated through an iterative process of analysis, construction, presentation, and feedback. The iteration included site visits, conference calls, corps-wide conference presentations, and was further supplemented with document reviews, individual phone calls, emails, and working document exchanges. An electronic document repository was created to manage the information collected concerning business lines, budgeting processes, asset assessment methods, data sources, interview summaries and project risk factors. The participating USACE personnel represented a cross section of executives, managers, and specialists across a diversity of organizational levels, functional tasks, geographic location, and business lines. As a group, they held a wide variety of backgrounds and specialties including: engineering application, economics, real estate, budgeting, engineering research, administration, and environmental sciences. The AISCE continues to perform infrastructure asset management projects using the five aspect model for the Federal Highway Administration, NASA, the National Oceanic and Atmospheric Administration, state government agencies, and the private sector.

### 4.3.6 References

ASCE. (2009). "Report Card for America's Infrastructure: Navigable Waterways." Retrieved 4/29/2009, 2009, from <http://www.infrastructurereportcard.org/fact-sheet/inland-waterways>.

GAO, United States General Accounting Office (2003). "High Risk Series: Federal Real Property." GAO-03-122 <http://www.gao.gov/cgi-bin/getrpt?GAO-03-122>.

GAO, United States Government Accountability Office (2007). "High Risk Series: An Update." January 2007. GAO-07-310 <http://www.gao.gov/cgi-bin/getrpt?GAO-07-310>.

GAO, United States General Accountability Office (2008). "Patricia A. Dalton, Managing Director Physical Infrastructure Issues, Testimony before the Committee on the Budget and the Committee on Transportation and Infrastructure, U.S. House of Representatives-Physical Infrastructure: Challenges and Investment Options for the Nation's Infrastructure." 5/08/08. GAO-08-763T <http://www.gao.gov/new.items/d08763t.pdf>.

Gell-Mann, M. (1994). *The quark and the jaguar : adventures in the simple and the complex* New York, NY, W.H. Freeman.



Heidegger, M. (1977). *The Question Concerning Technology and Other Essays*. New York, NY, Garland Publishing, Inc.

Holland, J. H. (1995). *Hidden order : how adaptation builds complexity*. Reading, Mass, Addison-Wesley.

Hooker, R. (1996). "Aristotle: The Four Causes- Physics II.3." Retrieved 08/04/28, from <http://www.wsu.edu:8080/~dee/GREECE/4CAUSES.HTM>.

Kauffman, S. A. (1995). *At Home in the Universe: The Search for laws of Self-Organization and Complexity*. New York, NY, Oxford University Press.

TRB (2004). *The Marine Transportation System and the Federal Role: Measuring Performance, Targeting Improvement - Special Report 279 / Committee for a Study of the Federal Role in the Marine Transportation System*. Washington, DC, Transportation Research Board of the National Academies.

USACE, U. S. A. C. o. E. (2006). *U.S. Army Corps of Engineers Asset Management Plan*. D. o. Defense, USACE Headquarters: 130.

## 4.4 A Multi-Objective Approach for the Management of Aging Critical Highway Bridges

Z. Lounis<sup>8</sup>, L. Daigle, D. Cusson, H. Almansour<sup>9</sup>

### 4.4.1 Introduction

Highway bridges are critical links in the transportation networks that enable personal mobility and facilitate transportation of goods on much longer transportation roads or corridors. Having a reliable Canadian transportation network is of utmost importance to ensuring public safety and security, preserving the high quality of life and competitiveness of Canada's economy. Hence, it is essential to ensure that the critical links of Canada's transportation network are kept safe, serviceable and functional as the failure of a single bridge can lead to a complete closure of the roadway and serious disruption of traffic.



Bridges are very complex infrastructure systems with several components that have different failure modes, as well as different consequences of failure.

Bridges are very complex infrastructure systems with several components that have different failure modes, as well as different consequences of failure. Bridges consist of three main sub-systems: (i) sub-structure; (ii) superstructure; and (iii) deck, which in turn consist of several components made of different materials, such as concrete, steel, timber, etc. There are several types of superstructure systems, including slab-on-girders, solid or voided slabs, rigid frames, box girders, arches, trusses, cable-stayed or suspension systems, which have different load distribution characteristics, behaviors, and modes of failure.

The preservation of aging bridges is estimated at hundreds of billions of dollars, which is more than can be accommodated by highway agencies.

A large number of these highway bridges in North America were built during the post-war construction booms of the 1950s, 1960s, and 1970s. Highway bridges are complex structural systems that deteriorate with time as a result of cumulative damage effects, increased loads, extreme shocks, inadequate inspection, maintenance and protection, poor workmanship and errors in design. The

preservation of these aging bridges is estimated at hundreds of billions

<sup>8</sup> Corresponding Author: Zoubir.Lounis@nrc-cnrc.gc.ca.

<sup>9</sup> All from National Research Council Canada, Institute for Research in Construction, Ottawa, ON, Canada, K1A 0R6

of dollars, which is more than can be accommodated by highway agencies.

The magnitude of the problem poses technological and economical challenges, specifically which bridges should be given high priority for preservation and protection and what are the optimal strategies that will achieve an acceptable trade-off between their risk of failure and life cycle costs. Many of the bridges in North America are considered deficient or vulnerable in terms of safety, mobility, and security. During their service lives, bridge systems and components deteriorate due to the cumulative damaging effects induced by traffic loads, corrosion, fatigue, and environmental effects (e.g. freeze-thaw cycles), as shown in Figure 4-14. In addition to this cumulative damage, bridges can be subjected to less frequent but severe natural and intentional shocks, such as earthquakes, extreme wind loads, flood, accidental loads due to ship or truck impacts, and possibly explosions from terrorist attacks that could lead to partial or total bridge collapse.

Bridges can be identified as critical in terms of safety and security if the consequences of their failure are very serious whereas some of these bridges may additionally reveal a high vulnerability to sudden shocks. The consequences of failure of such bridges can include fatalities, injuries, disruption/closure of disaster response route, illnesses, disruptions of traffic, as well as possible negative environmental and socio-economic impacts. The definition of minimum acceptable safety levels of aging bridges is a complex problem that requires the consideration of several criteria, including: (i) robustness and redundancy of structure; (ii) mode of failure (ductile or brittle); (iii) control of overload on bridge; and (iv) level of inspection of system or component.

The recent developments in sensors and wireless technologies can be used for the continuous or semi-continuous monitoring of the structural health, as well as for the security monitoring of the bridges that have been identified as critical. The recent developments in advanced materials such as high performance and ultra-high performance concrete, corrosion-resistant steel and advanced composites can be used to strengthen, protect and replace damaged bridge systems or components, and build new long-life bridges.



This paper presents an approach for multi-objective-based management of aging critical highway bridges to improve their life cycle performance. The proposed multi-objective optimization framework is presented as an effective approach that overcomes some of the limitations and complexities of cost-benefit or risk analyses, where all consequences are expressed in monetary terms. The framework prioritizes the critical bridges first, and then identifies the risk mitigation measures that can be used to satisfy several possible management objectives. Risk mitigation strategies can include more frequent or more in-depth inspections, load rating, monitoring of structural performance and security, rehabilitation and strengthening of damaged elements, and protection of weak and vulnerable components against extreme shocks due to natural hazards or intentional attacks. The implementation of the proposed approach is demonstrated on three examples that illustrate the prioritization process on a hypothetical network of 10 critical bridges.

**INFRASTRUCTURE TYPE:** Highway bridges

**Figure 4-14:**  
Impacts of deterioration,  
preservation, and protection  
on life cycle performance of  
bridges

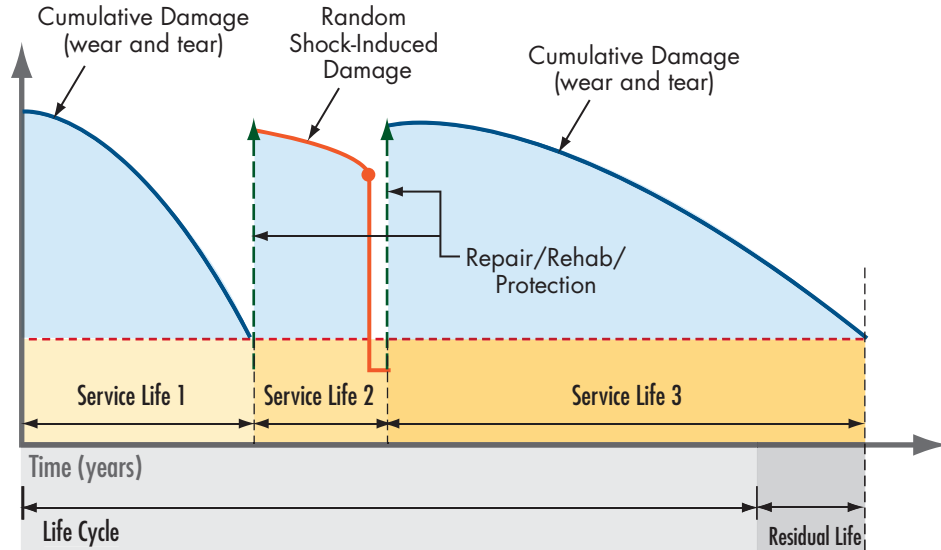

To address the problem of aging highway bridges, several transportation agencies have developed or initiated the development of bridge management systems to optimize the preservation of their deteriorated structures.

The widespread deterioration, some recent bridge collapses, and the growing concerns for sustainability and security of bridges have highlighted the importance of developing and implementing effective management strategies to improve their life cycle performance. The development and implementation of such management systems is a very complex and challenging problem given the size and age of the bridge network and the constraints on the available funds for their preservation and protection.

Different approaches to preservation optimization have been implemented in the different bridge management systems ranging from simplified heuristic or expert opinion-based approaches to more complex Markovian decision processes. The development of effective bridge management system depends primarily on the availability of reliable condition assessment methods and technologies that can be used to assess the current states and forecast the future states to develop cost-effective short- and long-term management plans. Given the large uncertainties in the occurrences of different types of loads and hazards, their magnitudes, current condition assessment methods, and deterioration of bridge systems, stochastic modeling of the load and capacity of bridges is required. Such

models will enable a more objective quantification of the probabilities of failure of the critical bridges and will help overcome some of the limitations of the qualitative models that are currently in use.

Furthermore, bridge management aims at improving the overall performance of a bridge or a network of bridges through the satisfaction of several objectives, which can include the minimization of maintenance costs, maximization of service life, minimization of risk of failure, minimization of bridge closures, accommodation of increased traffic, etc.

Multi-criteria optimization techniques provide a practical tool for optimal prioritizing of bridges for maintenance. In this paper, a multi-objective approach for the management of aging critical bridge structures is presented. It is based on the consideration of the minimization of risk of failure, minimization of maintenance costs at the project level, maximization of overall condition of critical highway bridges by undertaking the largest possible number of critical preservation and protection projects, and minimization of traffic disruption, with more emphasis on high-risk projects. The merits of multi-objective optimization approach are discussed. The compromise programming approach is used to determine the optimal solutions and a multi-objective criticality index is proposed as a parameter for the prioritization of projects for maintenance and protection. Three examples demonstrate the application of the proposed approach for the management of a small network of deficient highway bridge structures and illustrate different risk mitigation measures.

#### 4.4.2 Multi-Objective Management of Aging Bridges

The approaches to maintenance *optimization* implemented in the current bridge management systems are based on single objective optimization, and more specifically on the minimization of maintenance costs or life cycle costs, which represents the present value of all the costs incurred throughout the life cycle of a bridge structure, including, the costs of design, construction, maintenance, repair, rehabilitation, replacement, demolition and, in some instances, the users costs. The management of bridges is a multi-objective optimization problem as the bridge owner or manager seeks to satisfy implicitly and simultaneously several objectives, such as the minimization of costs to owners and users, improvement of public safety and security, improvement of serviceability and functionality, minimization of maintenance time, minimization of traffic disruption, etc. The solution of such bridge management problem can be obtained using the techniques of multi-criteria or multi-objective optimization presented below.

Despite its practicality and relevance, the use of risk as a criterion for decision-making in the management of highway bridges is not easy given the complexities of assessing the probability of failure, as well as the consequences of failure. In the current life cycle cost or cost-benefit analyses, which have been implemented in many bridge

Given the difficulty of accepting the notion of placing any sort of value on human life, Starr (1969) instead evaluated the risk of death from various causes and identified two general categories for risk of death: (i) risk associated with voluntary activities (e.g. risk of death from driving a car) in which the individual evaluates and adjusts his exposure to risk; and (ii) risk associated with involuntary activities (e.g. risk of death due to failure of a bridge), where the risk levels are specified by regulations from governmental agencies. Starr (1969) indicated that the public typically was willing to accept a level a risk 1,000 times greater for voluntary risks than for involuntary risks. Paté-Cornell (1994) proposed a range of acceptable levels of death risk for the public and workers that varies quite widely from 1/100,000,000 to 1/1000 deaths/exposed person/year.

management systems that are used by different transportation agencies in North America, all losses, including fatalities, injuries, and social costs are quantified in monetary terms. This means that a monetary value must be assigned to human life, and various methods have been developed.

It is clear from the above discussion that the existing approaches to decision making have serious limitations, as they express all losses in monetary terms and consider only one criterion at a time, e.g., minimization of owner costs. In this paper, a multi-objective approach for decision-making, which can incorporate all relevant objectives, is proposed to help solve the bridge management problem. Such an approach enables a better evaluation of the effectiveness of preservation and protection strategies in terms of several objectives (safety, security, mobility, cost) and determines the optimal solution that achieves the best trade-off between all of them (including conflicting ones, such as safety and cost). Figure 4-15 outlines the proposed framework for multi-objective management of highway bridge structures. The development and implementation of this framework will provide effective decision support to bridge owners and managers in optimizing the allocation of their limited funds, as well as improving the life cycle performance of their bridges.

Several approaches have been developed to solve multi-objective optimization problems, including multi-attribute utility theory (Von Neumann and Morgenstern 1947; Keeney and Raiffa 1976), weighted sum approach (Zadeh 1963), compromise programming, constraint approach, and sequential optimization (Koski 1984; Lounis and Cohn 1993, 1995). In this paper, the compromise programming approach is used to solve the multi-objective management problem.

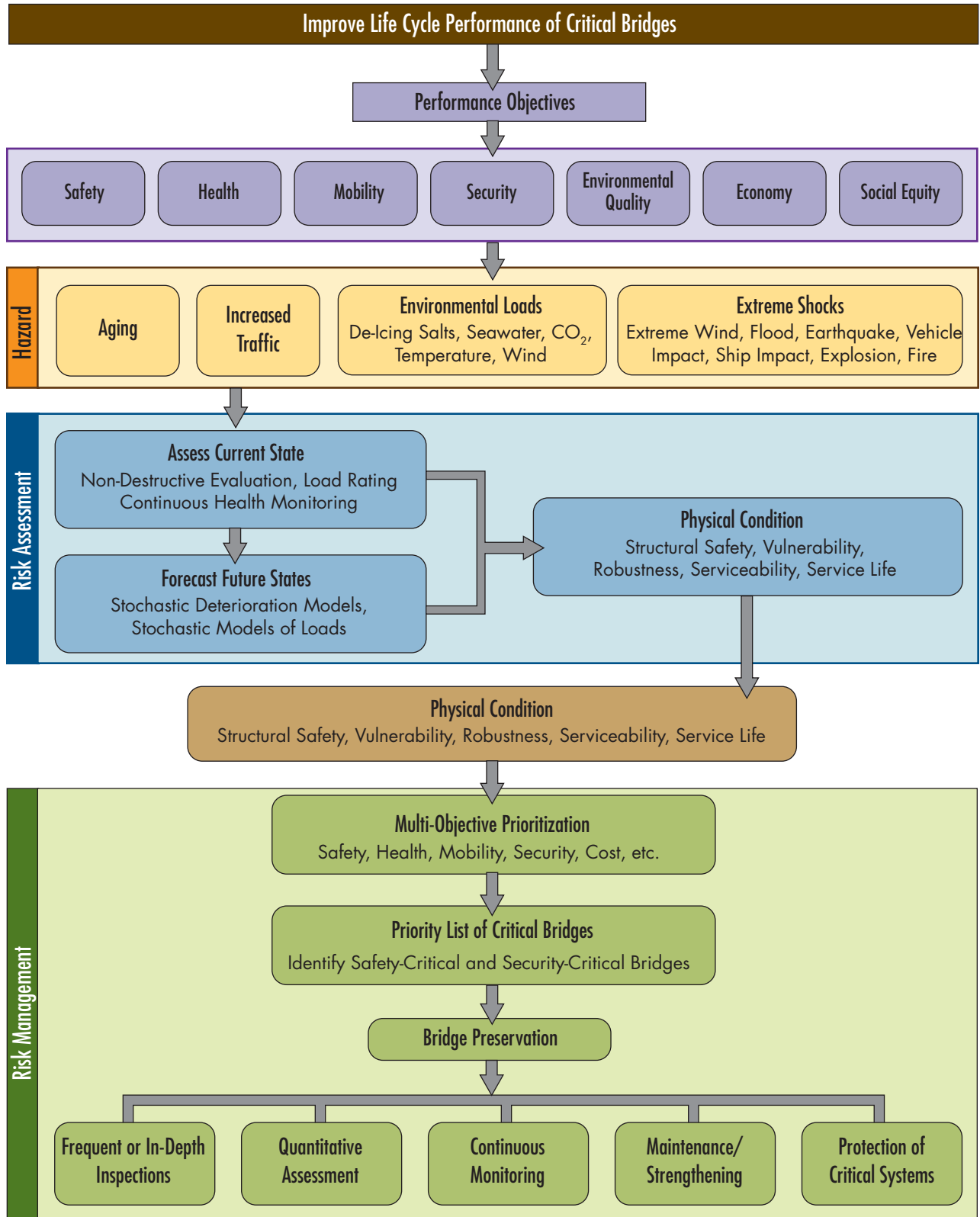

Figure 4-15: Framework for multi-objective management of aging highway bridges

In multi-objective (or vector) optimization problems, the notion of optimality is not that obvious because of the presence of multiple, incommensurable and conflicting objectives. In general, there is no single optimal (non-dominated or superior) solution that simultaneously yields a minimum (or maximum) for all objective functions. The Pareto optimality concept has been introduced as the solution to multi-objective optimization problems (Koski 1984; Lounis and Cohn 1993). A maintenance strategy  $\mathbf{x}^*$  is said to be a Pareto optimum if and only if there exists no maintenance strategy in the feasible set of maintenance alternatives that may yield an improvement of some criterion without worsening at least one other criterion. The multi-criteria maintenance optimization problem can be mathematically stated as follows:



Find:  $\mathbf{x}^* = \text{Optimum}$

Such that:  $\mathbf{f}(\mathbf{x}) = [f_1(\mathbf{x}), f_2(\mathbf{x}) \dots f_m(\mathbf{x})]^T = \text{minimum } \mathbf{x} \in \Omega$  (1a)

$$\sum C(\mathbf{x}) \leq B \quad (1b)$$

$$\Omega = \{\mathbf{x} \in N: \beta_{th} \leq \beta(\mathbf{x}) \leq \beta_{min}\} \quad (1c)$$

where  $\mathbf{f}$  = vector of  $m$  optimization objectives (e.g. safety, security, cost, mobility);  $C(\mathbf{x})$  = cost of maintenance or protection strategy ( $\mathbf{x}$ );  $\Omega$  = subset of the bridge or bridge network that at a specific time contains critical bridge components/systems having a reliability index ( $\beta$ ) between a threshold value (safety-critical) and a maximum value controlled by cost;  $B$  = Budget constraint for maintenance and protection work;  $N$  = entire set of bridges requiring maintenance and protection; and  $T$  = transpose symbol.

The concept of Pareto optimality mentioned above, may be stated mathematically as follows (Koski 1984; Lounis and Cohn 1993):



$\mathbf{x}^*$  is a Pareto optimum if:

$$f_i(\mathbf{x}) \nless f_i(\mathbf{x}^*) \quad \text{for } i = 1, 2, \dots, m \quad (2a)$$

with

$$f_k(\mathbf{x}) < f_k(\mathbf{x}^*) \quad \text{for at least one } k \text{ (one of the } m \text{ objectives)} \quad (2b)$$

Figure 4-15 is a schematic illustration of the conflicting nature of the criteria of minimization of maintenance/protection costs and minimization of normalized probability of failure. In general, there are several Pareto optimal solutions (also called non-dominated solutions) for a multi-objective optimization problem as shown in Figure 4-16. In this figure, two dominated solutions are also shown to illustrate the concept of dominance. Once the set of Pareto optima is generated, the “best” solution that achieves the best compromise between all competing objectives



is sought. Such a solution is referred to as “satisficing” solution in the multi-objective optimization literature (Koski 1984; Lounis and Cohn 1993, 1995).

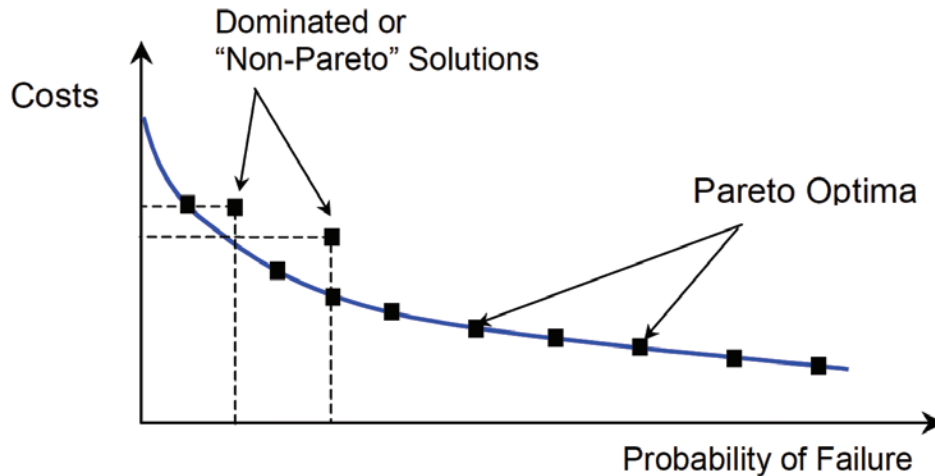

Figure 4-16: Schematic illustration of Pareto optima and conflicting optimization objectives

In compromise programming, the so-called “*satisficing*” solution is defined as the solution that minimizes the distance from the set of Pareto optima to the so-called “ideal solution.” This ideal solution is defined as the solution that yields minimum (or maximum) values for all criteria. Such a solution does not exist, but is introduced in compromise programming as a target or a goal to get close to, although impossible to reach. Lounis and Cohn (1993, 1995) proposed a multi-objective optimality or criticality index, “MCI,” as a criterion for ranking competing bridge design alternatives. The criterion used in compromise programming is the minimization of the deviation from the ideal solution  $\mathbf{f}^*$  measured by the family of  $L_p$  metrics (Lounis and Cohn 1993, 1995). In this paper, the multi-objective criticality index, “MCI,” is defined as the value of the weighted and normalized deviation from the ideal solution  $\mathbf{f}^*$  measured by the family of  $L_p$  metrics:

$$\text{MCI}(\mathbf{x}) = \left[ \sum_{i=1}^m w_i^p \left| \frac{f_i(\mathbf{x}) - \min f_i(\mathbf{x})}{\max f_i(\mathbf{x}) - \min f_i(\mathbf{x})} \right|^p \right]^{1/p} \quad (3)$$

*f* Equation

This family of  $L_p$  metrics is a measure of the closeness of the satisficing solution to the ideal solution. The value of the weighting factors  $w_i$  of the optimization criteria  $f_i$  ( $i=1, \dots, m$ ) depends primarily on the attitude of the decision-maker towards risk in terms of both public safety and public security. In this paper, structural safety is considered as the governing objective therefore a higher weight is placed on the objective of maximization of the reliability index. However, the optimization will

also be carried out for equal weighting of all criteria to show the impact of weighting factors on the optimal decision. The choice of “p” indicates the importance given to different deviations from the ideal solution. For example, if  $p=1$ , all deviations from the ideal solution are considered in direct proportion to their magnitudes, which corresponds to a group utility (Duckstein 1984). However, for  $p \geq 2$ , a greater influence is given to larger deviations from the ideal solution, and  $L_2$  represents the Euclidian metric. For  $p=\infty$ , the largest deviation is the only one taken into account and is referred to as the Chebyshev metric or minimax criterion, and  $L_\infty$  corresponds to a purely individual utility (Duckstein 1984; Koski 1984; Lounis and Cohn 1995). In this paper, the Euclidean metric is used to determine the multi-objective criticality index and corresponding “satisficing” solution.

### 4.4.3 Strategies for Management of Critical Bridges

As mentioned earlier, existing highway bridges may be subjected to different types of hazards with very different likelihoods and consequences within their life cycles. These hazards can be grouped into three different categories:

- Progressive cumulative damage such as corrosion, increased traffic loads, fatigue, aggressive environmental factors;
- Extreme natural or accidental hazards such as earthquake, extreme wind, flooding, truck and ship impact on bridge structures; and
- Extreme intentional hazards, such as terrorism acts (explosives), vandalism acts, etc.

For a given component/system and a given failure mode, the load effect and strength are time-dependent and present considerable uncertainty in their mean values as well as in their levels of scatter, which increase with time. In general, the strength decreases with time due to corrosion,

fatigue, and overload. As a result, the safety margin and the corresponding reliability index decrease with time. The prediction of the reliability of a bridge structure throughout its life cycle should be based on a probabilistic modeling of the load and strength of the bridge structure and system, and on the use of appropriate analytical or numerical structural reliability analysis methods. The failure and the end of life of a bridge structure can be defined as the time interval at which the reliability index reaches a limit state or minimum acceptable level, as shown in Figure 4-14. This minimum value

For a given component/system and a given failure mode, the load effect and strength are time-dependent and present considerable uncertainty in their mean values as well as in their levels of scatter, which increase with time.

depends on the mode of failure considered, the bridge element or system, the redundancy of the system, and the consequences of failure. This service life is the time at which a major maintenance or protection action is required, which can be rehabilitation, strengthening, protection, or replacement, after which the reliability may be increased to an adequate level. An overview of the different strategies that can be used to reduce the risk of failure of highway bridges is provided in the next sections.

#### 4.4.3.1 Performance-Based Inspection

Most highway agencies recommend that visual inspections of bridges be carried out every two years (e.g. MTO 2000, FHWA 1979). In addition, it is expected that maintenance crews perform routine inspection to identify sudden changes in bridge condition on a more frequent basis. For bridges identified as critical for safety or security reasons, it is proposed that more frequent inspections or specialized investigations should be conducted especially when they meet anyone of the following criteria:

- Structures with single load paths or limited redundancy (in-depth inspection);
- Structures with a critical element in the “poor” condition state (structure evaluation, load testing).
- Structures with load limits;
- New types of structures, materials or details with no previous performance history (more frequent inspection/in-depth inspection of details);
- Structures with fatigue prone details (fatigue investigation);
- Structures with fracture-critical members (X-ray investigation);
- Pins and hangers in arch structures (in-depth inspection); and
- Pins in suspended spans and pinned arches (in-depth inspection).

For critical bridges, specialized inspections such as seismic investigation, underwater investigation and substructure condition surveys should be mandatory especially when the likelihood of occurrence of one or more of these extreme shocks (flood, earthquake, vehicle impact, ship impact) is high or even moderate.



Most highway agencies recommend that visual inspections of bridges be carried out every two years.

For critical bridges, specialized inspections should be mandatory especially when the likelihood of occurrence of one or more of these extreme shocks (flood, earthquake, vehicle impact, ship impact) is high or even moderate.

#### 4.4.3.2 Quantitative Condition Assessment and Deterioration Prediction

The most widely used model for the deterioration prediction of bridges and other type of infrastructures is the Markov chain model. This model is being adopted by several highway agencies in their bridge management systems (such as *Pontis*, *Bridgit* and other systems) at both network and project levels (Golabi *et al.* 1992, Hawk 1999, Thompson *et al.* 1999). It is based on a discretization of the condition of the bridge elements/systems into a finite set of states (i.e. excellent, good, fair, poor) and probabilities that the element or system will jump from one condition state to the next state within a unit time period. These probabilities are most of the time obtained from expert opinions or from a combination of expert opinions and historical data when available using Bayesian updating.

The main advantages of the Markov type models are their compatibility with existing qualitative/discrete bridge condition rating systems and simplicity to use. These models are very practical at the network level, where decisions need to be made on a large number of systems and at different points in time. However, for critical aging highway bridges, the Markov type models have shortcomings that can be summarized as follows:

- The damage states are often based on qualitative condition ratings of bridges that are not uniquely related to measurable physical quantities;
- Qualitative models are inadequate for severely damaged bridges for which safety may become an issue as they only provide a qualitative prediction of the future condition of the asset (e.g. excellent, good, fair, poor);
- Only cumulative damage effect can be modeled (i.e. progressive accumulation of damage with time “wear and tear”), thus cannot predict shock-induced failures caused by extreme events



The prediction of the safety of critical highway bridges should be based on rigorous and quantitative models that can provide reliable measures of the remaining capacity of the asset or its probability of failure.

The prediction of the safety of critical highway bridges should be based on rigorous and quantitative models that can provide reliable measures of the remaining capacity of the asset or its probability of failure. If the bridge or a critical element of the bridge is severely deteriorated and its capacity is seriously reduced, it is very important to ensure that the probability of failure does not exceed a specified acceptable level. Generally, the load and capacity are time-dependent and random. Changes in both of their mean values and

standard deviations could occur. Very often, the load tends to increase (due to increasing demand), while the capacity tends to decrease due to deterioration. Similarly, the variability or standard deviation of the load may increase with time due to lower confidence in predicting the load for longer periods of time, while the variability or standard deviation of the capacity may increase due to uncertainty in predicting the effect of different deterioration mechanisms on the capacity of the system. Therefore, for a reliable and quantitative assessment of the performance of critical bridges, the use of more advanced stochastic processes is required. This complex time-dependent reliability problem could be schematically represented as shown in Figure 4-17. Since both the load and capacity are stochastic processes, the prediction of the probability of failure can be formulated as a first passage or crossing time problem and solved using time-dependent reliability analysis methods (Lounis et al. 2003; Mori and Ellingwood 1993). However, for service life prediction and reliability assessment in general, the quantity of interest is not the above instantaneous probability of failure, but rather the probability of failure within an interval of time. The time at which the load crosses the barrier defined by the capacity of the system for the first time is the time to failure and is a random variable. The probability that the capacity is less than the load within the time interval is called the “first passage probability.” As pointed out earlier, the solution of the crossing problem is rather difficult, because the complete history of the stochastic processes within the time interval require a considerable amount of quantitative data on the load (that can be obtained with structural health monitoring) and capacity.

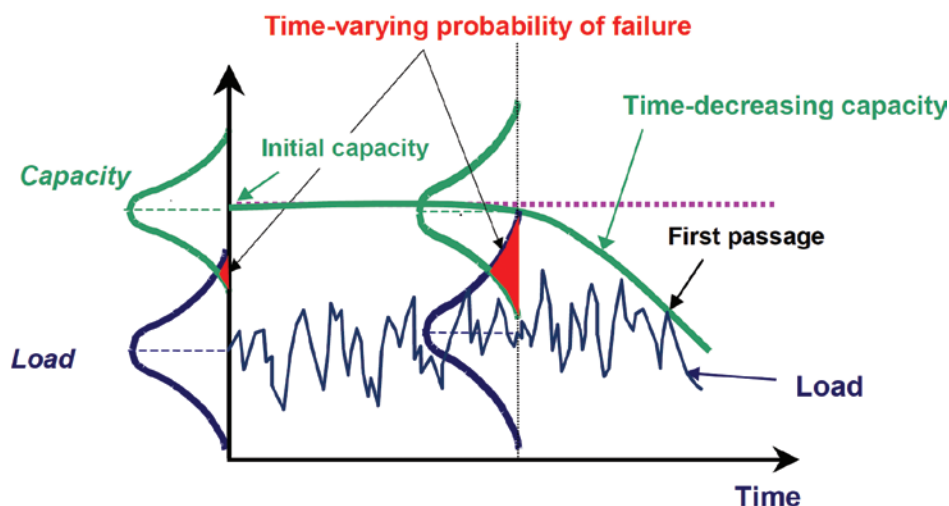

Figure 4-17:  
Schematic illustration of  
a crossing problem with  
stochastic load and capacity

#### 4.4.3.3 Continuous/Semi-Continuous Structural Health Monitoring

The implementation of monitoring strategies can help improve the safety and security of bridges and optimize their in-depth inspection, maintenance, repair, rehabilitation, and replacement to reduce their life cycle costs. The continuous and simultaneous measurements at critical discrete points of a deteriorating bridge system can allow the assessment



The implementation of monitoring strategies can help improve the safety and security of bridges and optimize their in-depth inspection, maintenance, repair, rehabilitation, and replacement to reduce their life cycle costs.

of its performance with respect to different limit states, including safety and serviceability. Moreover, deterioration prediction models can be developed or calibrated from such monitoring data, which can optimize intervention strategies as to how and when to repair or rehabilitate, thus extending the service life of highway bridges. The majority of Canada's bridges are short and medium-span bridges that exhibit serious deterioration induced by corrosion due to the use of de-icing salts and compounded by increased traffic loads. On the other hand, long-span bridges are very critical structures

for their very high initial cost and high volume of traffic. The failure of long span bridges can be catastrophic with a large number of fatalities. Furthermore, such structures can be identified as security-critical.

Long-span bridges are sensitive to reductions in the flexural and torsional stiffness induced by corrosion damage and overload in the superstructure.

Long-span bridges are sensitive to reductions in the flexural and torsional stiffness induced by corrosion damage and overload in the superstructure. Their performance is usually controlled by serviceability limit states. The vibration amplitude of the deck due to traffic or wind can become a serious problem, which is further compounded by aging and deterioration that could lead to a significant

change of the vibration modes, resulting in serious reduction of the bridge fatigue resistance. Hence, the dynamic performance parameters of long-span bridges should be considered first in a monitoring strategy that would include sensors such as accelerators, pressure (for wind) and deformation sensors. Long span bridges are very flexible systems, which can enable them to absorb some of the damage induced by extreme shock such ship impacts or explosions, assuming no significant local failure. The most effective monitoring technique to mitigate the risk of extreme shocks is the continuous video surveillance as part of the alert/avoidance system.

Structural health monitoring (SHM), either with embedded sensors or by actual field-testing, is an evolving technology that allows monitoring the condition of existing or new civil engineering structures.

Implementation of SHM as an essential part of structural design will be key to the development of the next generation of long-life smart bridges. Intelligent sensing systems may be composed of four main elements: (i) sensors and actuators collecting data and taking action in an environment of interest; (ii) a network for the transmission of data and control signals; (iii) systems for data management and visualization; and (iv) specific analysis and decision-making applications. Figure 4-18 illustrates the concept of SHM for a bridge structure.

The selection of the required types and number of sensors located at discrete and critical points in a given bridge relies on the type of bridge and the experience of the engineer and his/her knowledge of the physical, chemical and mechanical processes, and on the budget allocated for SHM. In a larger context, monitoring data can be considered similar to quality assurance and acceptance sampling, since it is not realistically feasible to monitor all performance indicators in all sections of an entire bridge (Frangopol et al. 2008). In-depth information on the design of SHM systems and specific bridge applications can be found elsewhere (Mufti 2001). Structural health monitoring can benefit owners and users of bridge structures in four different areas (Cusson et al. 2009):

- (i) Ensuring public safety;
- (ii) Development and adoption of new construction technologies;
- (iii) Development of prediction models; and
- (iv) Update of loading data for the design of bridges

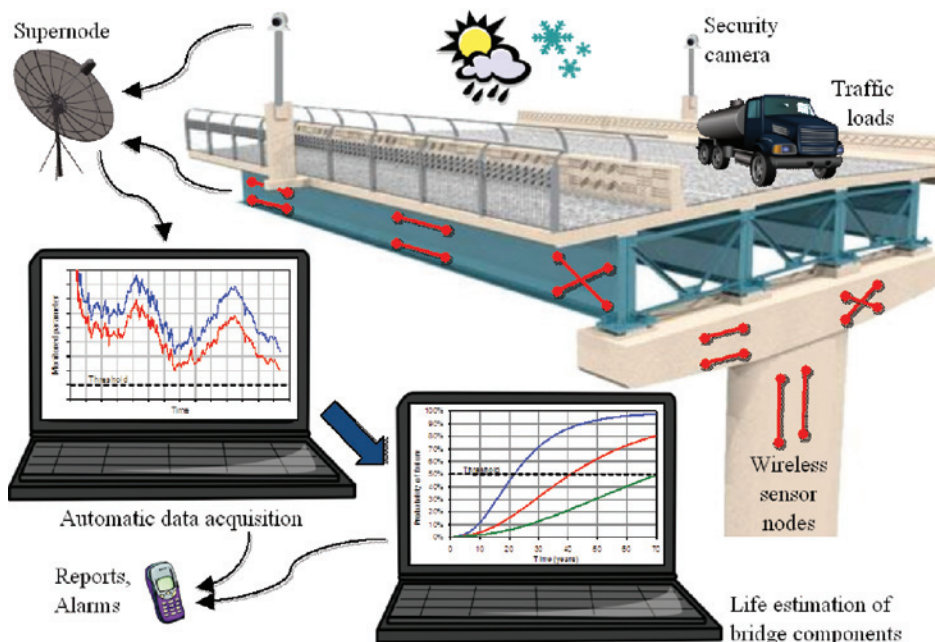

Figure 4-18:  
Schematic of structural health and security monitoring systems of bridges

#### 4.4.3.4 Continuous Security Monitoring

A continuous video camera surveillance system can be installed to monitor the bridge and immediate surroundings in order to identify and respond to potential threats to the bridge and its components, including deck, piers, approaches, telecommunication, traffic control, lights, etc. Different types of activities can be monitored depending on type of bridge, such as car and truck traffic as well as boats, ships and aircraft activities. Computer vision and pattern recognition technology can also be used to allow computers to process recorded images, watch for danger signs, and send alarms automatically to security officers. Such technologies require high-speed communication systems to deliver the information to remote security offices for analysis, reporting and archiving purposes. It is possible though to process and archive the images locally; however, this would not allow post-catastrophe analysis (FHWA 2009).

#### 4.4.3.5 Rehabilitation, Strengthening and Protection of Critical Bridge Systems and Components

The “wear and tear” deterioration caused by lifetime cyclic loading, aging and external environment (freeze-thaw cycles, de-icing salts) reduces bridge serviceability and affects the effective mobility of the users. Wear and tear deterioration also reduces the capacity and the dynamic characteristic performances of bridge components and overall system. These changes in the structure’s original properties diminish its capability to absorb and distribute shocks and could potentially result in a sudden collapse. For long span bridges, increase of wind load intensity and frequency due to climate change may lead to a significant increase of the deck forced vibration and possible deck flutter. Such changes require the development of innovative strengthening techniques to improve its dynamic performance. Rehabilitation methods for wear and tear deterioration are numerous including: patch repair, concrete overlays, partial or complete deck replacement, electrochemical chloride removal, routing and sealing of cracks, crack injection, etc.

The “wear and tear” deterioration caused by lifetime cyclic loading, aging and external environment reduces bridge serviceability and affects the effective mobility of the users.

Bridge strengthening is required when the original bridge capacity has been reduced due to aging, “wear and tear” or/and extreme shocks-induced deterioration, or when the actual or expected loads exceed the design values. Existing strengthening and protection techniques focus on enhancing the strength and/or ductility of structural elements. Methods used include: (i) external steel plates attached to the external surface of bridge elements and connected to the main reinforcement; (ii) external prestressing steel or fiber-reinforced polymer (FRP) tendons; (iii)



increase of reinforced concrete element cross section by attaching a pre-cast or cast in place reinforced concrete external part; (iv) cladding/layer compositely connected to the strengthened element; and (v) use of FRP laminates to confine reinforced concrete columns.

In many situations, and depending on the magnitude of the extreme shock, it is not expected from a protection system to prevent bridge collapse, but to rather delay its failure or to transform an expected sudden type failure into a multi-staged or ductile one. The major issue in the development of a bridge or element protection system is to identify which element(s) is the most critical foreseeing that its failure could potentially lead to a complete bridge failure especially for single load path or low redundancy bridge systems. For example, the pier of a single pier bridge or the interior girder of a three girder slab-on-girder bridge, or the key joint in a simply supported truss represents highly critical elements.

The effectiveness of a protection system against extreme shock loads is measured by its capability to absorb and distribute the concentrated impact over a wider region. This will help avoid severe local damage and allow the deformation of a critical zone of a structural element to extend far beyond the protected element itself. There are many new promising materials and techniques that can be used to strengthen and protect bridge structures, such as:

- **High-strain-rate advanced composites:** These materials have very wide range of strength, strain and shock-distribution properties that are suitable in the development of extreme shock protection elements. As an example, an efficient protection system for concrete columns, beams, and slabs could be developed using advanced composite sandwich panels formed from two external layers of high-strain-rate FRP and a shock absorbing material as an intermediate layer.
- **Ultra high performance concrete (UHPC):** This material has very high compressive and tensile strengths, and very high durability compared to traditional concrete. An UHPC cladding or protecting layer externally bonded to a bridge pier or any security critical zone could significantly delay or even avoid a possible failure due to a large impact or a blast load. The steel fibers in UHPC can bridge the microcracks normally initiated in concrete by external or internal stress fields. The steel fiber action contributes to the highly ductile behavior and very high fatigue resistance of UHPC structures (Almansour and Lounis 2008). These properties make UHPC a very suitable material for extreme shock protection in addition to prevent any possible premature failure.

- **External protection system for piers:** A wall or dynamic absorption components may be built close to the bridge piers as a protection system to avoid direct exposure of critical bridge elements to extreme loads.
- **Avoidance mechanisms:** Technologies such as weigh-in-motion scale and flashing static signs or variable message signs that warn drivers of overweight trucks to follow a detour route can also be considered.

It is important to mention that, for critical aging bridges, the installation of strengthening/protection systems applied to parts of the bridge structure have to be combined with rehabilitation when the condition of the structure is inadequate.

#### 4.4.4 Illustrative Examples

##### Example 1: Prioritization of safety-critical bridges for maintenance and protection

The approach presented in this paper is applied for the maintenance optimization of 10 aging and deficient structures within a network of a given transportation agency. In this example, the feasible maintenance and protection strategies are assumed to be optimized for the individual deficient bridge based on the conventional life cycle costs minimization approach. The objective here is to optimize the prioritization of the 10 maintenance projects considering simultaneously their reliability, maintenance cost, and average daily traffic subject to the constraint of a total available budget of \$1.65 Million. The average daily traffic is a very relevant criterion as it indirectly provides a rating of the importance of the bridge relative to the service provided to the users and the socio-economic activity. If the bridge is posted or closed, users incur immediate economic impacts leading to higher travel costs due to longer travel time, higher fuel consumption, lost time, higher vehicle maintenance costs, and increased environmental impacts due to increased fuel consumption and gas emissions. It can be defined as a criterion for the control of traffic disruption. The reliability of bridge structures is measured by the reliability index, which can be related to the probability of failure using the following approximation:  $P_f = \Phi(-\beta)$ , where  $\Phi$  is the cumulative distribution function of the standard normal distribution. A reliability index of 2 corresponds to a nominal probability of failure of 0.02, while a reliability index of 3 corresponds to a nominal probability of failure of 0.0013 (an order of magnitude lower). It should be pointed out that increasing the reliability of an existing structure is much more problematic and expensive than specifying a higher reliability index at the design stage, prior construction.

Table 4-2 shows the values of the reliability index, maintenance/protection cost and average daily traffic associated with each bridge project, while Figure 4-19 shows their normalized values (with regard to the maximum value). Figure 4-20 illustrates the conflicting nature of these objectives and the difficulty in prioritizing, as the project with the highest urgency in terms of safety (Project #3) is not ranked number one in terms of maintenance/protection cost (Project #9) or in terms of mobility or traffic (Project #5). The safety levels shown in Table 4-2 are relatively low given that these bridge structures are being continuously monitored and all assessed structures are assumed redundant (i.e. the failure of a structure will lead only to local failure and not to total collapse). In the case of less robust and less redundant structures, much higher values for the minimum reliability index will be required.

Using the compromise programming and the  $L_2$  metric, the proposed multi-objective criticality index (MCI) is determined for the investigated bridge projects for two cases: Case 1: Weighted MCI, in which weights of 0.5, 0.3, and 0.2 are assigned to safety, maintenance/protection cost, and average daily traffic, respectively (i.e. a risk averse preference).

Table 4-2: Multi objective-based prioritization of critical bridge structures

Safety-Critical Structure #	Reliability Index	Maintenance & Protection Costs (\$1,000)	Average Daily Traffic	Weighted Multi-Objectives Criticality Index (w-MCI)	Non-Weighted Multi-objectives Criticality Index (MCI)
1	<b>2.00</b>	520	5,000	0.239	0.969
2	2.30	364	7,000	0.296	0.869
3	<b>1.92</b>	350	12,000	<b>0.118</b>	<b>0.429</b>
4	2.34	832	7,000	0.421	1.290
5	2.65	125	<b>15,000</b>	0.468	0.938
6	2.35	150	7,000	0.303	0.828
7	2.18	100	1,900	0.261	1.054
8	2.10	125	2,000	0.230	1.020
9	2.50	<b>75</b>	2,000	0.421	1.240
10	2.70	150	12,000	0.503	1.031
		Total = 2,791		Obtained from Eq. 3	Obtained from Eq. 3

Figure 4-19:  
Normalized Values of  
Prioritization Criteria for  
Maintenance and Protection  
Projects

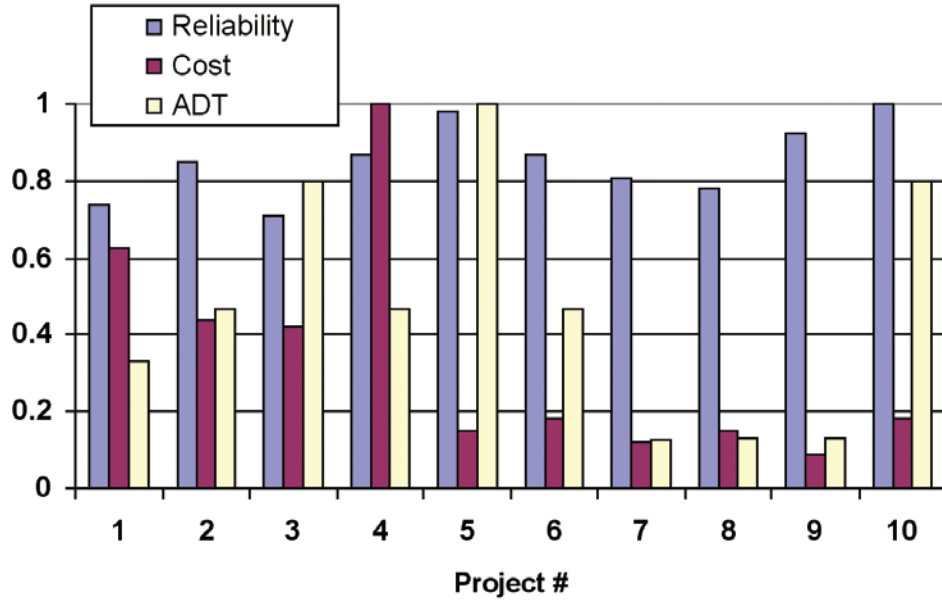
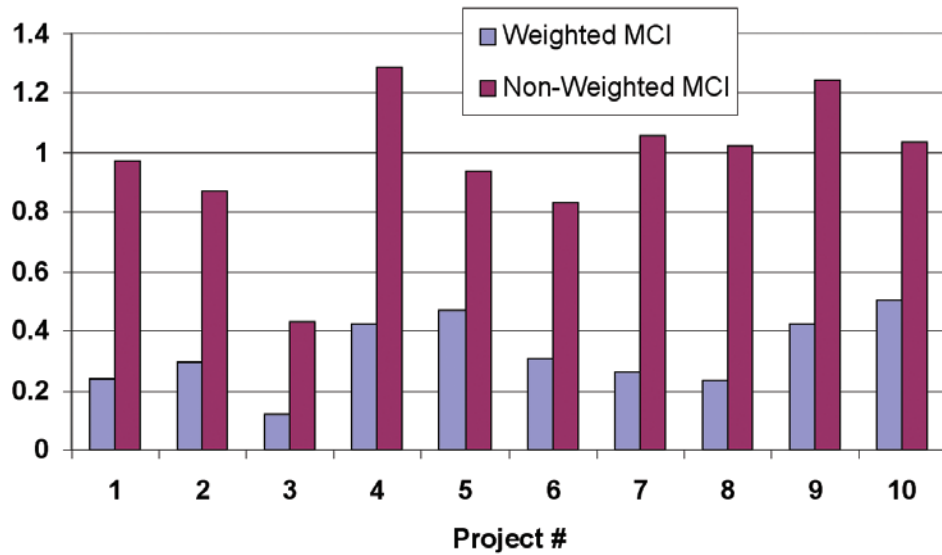

Figure 4-20:  
Weighted and non-weighted  
multi-objective criticality  
indices



The total maintenance and protection cost for these 10 projects is \$2.791 million, which is well in excess of the available budget of \$1.65 million. From Table 4-2, the “ideal” (but non-existing) solution is associated with the following “ideal” criterion vector  $\mathbf{f}^* = [f_{1\min} \ f_{2\min} \ f_{3\max}]^T = [1.92, 75000, 15000]^T$ . Using the weighted MCI (Table 4-2 and Figure 4-21), the satisficing solution is found to be Project # 3 for both weighted and non-weighted cases. Figure 4-21, however, illustrates the differences in the ranking for the other projects. For example, the second highest priority is Project #8 for weighted MCI and Project # 6 for non-weighted MCI, which is due to the higher importance given to reliability in the weighted objectives. The difference in ranking between these two MCI indices varies from 0 for Project #3 to 5 ranking levels for Project # 5.

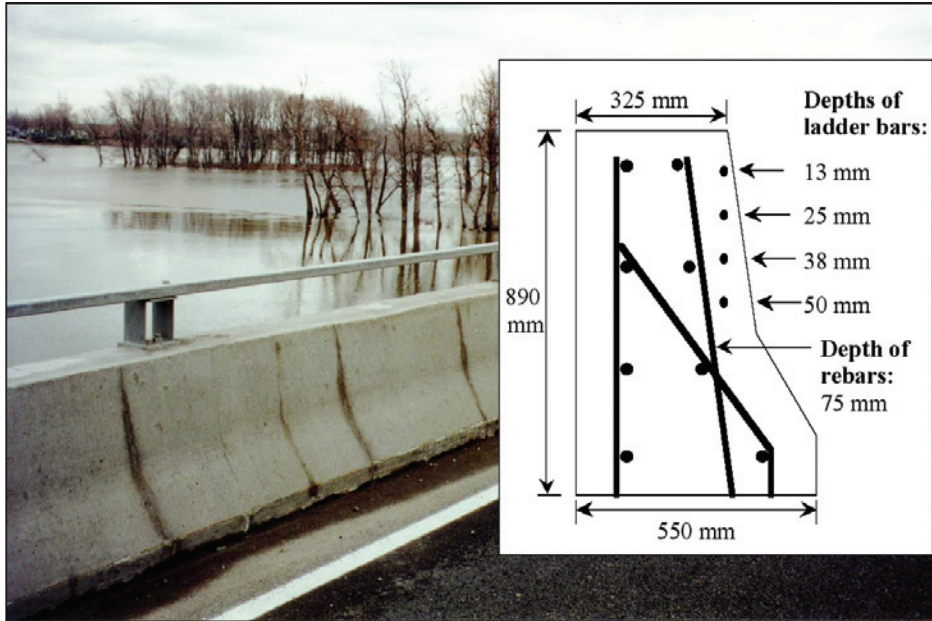

Figure 4-21:  
Cross-section of reconstructed  
barrier wall (Vachon Bridge,  
Laval, Canada)

Considering now the budgetary constraint, the following projects will be scheduled for maintenance and protection:

- Weighted MCI-based prioritization: Projects #3, #8, #1, #7, #2, and #4 for a total cost of \$1.609 million. The other projects are delayed to the following year; however, detailed analysis is required to assess if bridge posting or closure is needed.
- Non-Weighted MCI-based prioritization: Projects #3, #6, #2, #5, #1, and #8 for a total cost of \$1.634 million. The other projects are delayed to the following year; however, detailed analysis is required to assess if bridge posting or closure is needed.

### Example 2: Health monitoring of corrosion-damaged bridge deck

This case study is provided to demonstrate that stochastic deterioration models are efficient tools to assess the future physical condition and predict the service life of critical bridges. Input data obtained from field testing, as compared to generally suggested values, significantly improve the resulting predictions because they can capture time and location variations of the main influential parameters.

In 1996, the Ministry of Transportation of Québec undertook the rehabilitation of the Vachon Bridge, which is a major highway bridge in Laval (near Montreal) Canada. Part of the rehabilitation consisted of rebuilding the severely corroded barrier walls, of which ten 35-m long spans were selected for the application and evaluation of corrosion inhibiting systems. The wall reinforcement consisted of 15-mm diameter bars as

illustrated in Figure 4-22. The concrete had a water-cement ratio ( $w/c$ ) of 0.36 (selected to obtain low permeability), a cement content of  $450 \text{ kg/m}^3$ , and an average 28-day strength of 45 MPa. On-site surveys of the barrier wall were performed annually from 1997 to 2006, including measurements of corrosion potential and corrosion rate in the barrier wall, of which the concrete cover was 75 mm. For early detection of corrosion, sets of rebar ladders were embedded during construction. The ladder bars had concrete cover thicknesses of 13 mm, 25 mm, 38 mm, and 50 mm (Figure 4-22), allowing additional corrosion measurements to be taken. More details can be found in Cusson and Qian (2009).

Figure 4-22:  
Measured and predicted  
profiles of total chloride  
content after 10 years

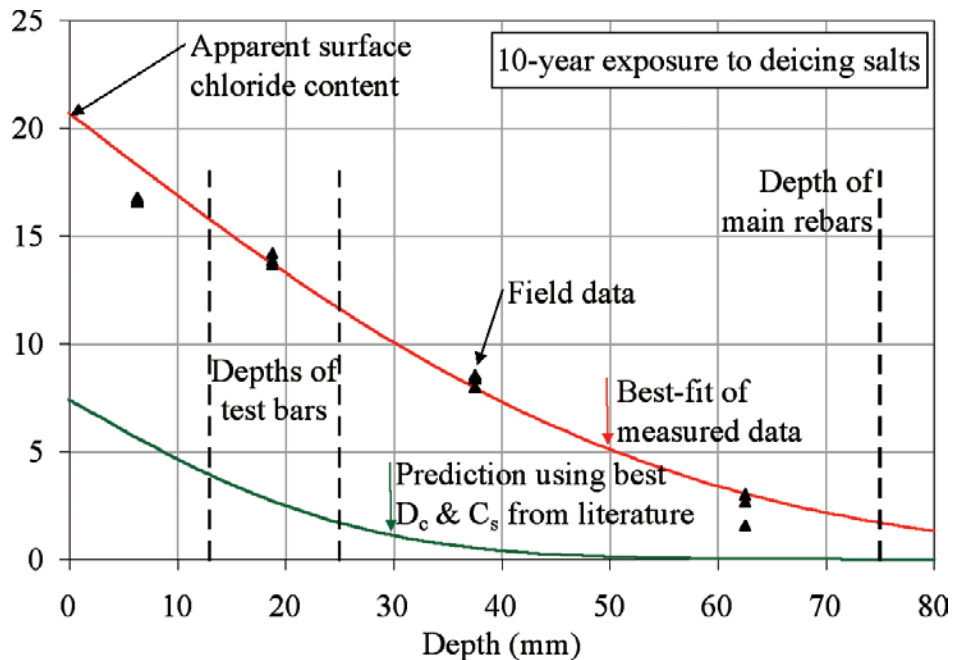

Concrete cores were taken from the bridge barrier walls after 1, 2, 4, 5, 8 and 10 years of exposure to deicing salts in order to test several parameters, including chloride concentration. Of the 10 spans of barrier wall under study, three of them had identical concrete formulations and concrete surface conditions (referred to as Spans 12, 19 and 21 in Cusson and Qian 2009).

Figure 4-23 presents the average total chloride contents measured in concrete after 10 years of exposure to deicing salts.

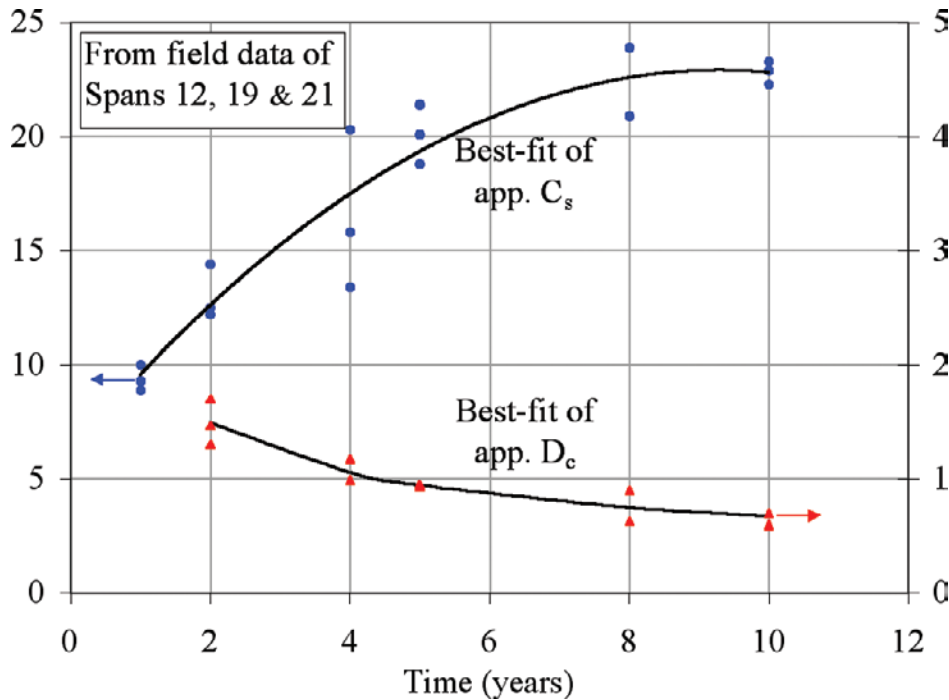

Figure 4-23: Measured apparent surface chloride contents and chloride diffusion coefficients over 10 years

The best-fit curve was obtained by linear regression analysis of the measured data and Crank's solution to Fick's second law of diffusion (Crank 1975, Tuutti 1993):

$$C(x,t) = C_s \left( 1 - \operatorname{erf} \left( 0.5 x / \sqrt{D_c t} \right) \right) \quad (4)$$

*√f* Equation

where  $C(x,t)$  is the chloride concentration at depth  $x$  after time  $t$ ;  $C_s$  is the apparent surface chloride concentration;  $\operatorname{erf}$  is the error function, and  $D_c$  is the apparent chloride diffusion coefficient. From the field data, an average apparent surface chloride content of  $20.7 \text{ kg/m}^3$  and an average apparent chloride diffusion coefficient of  $0.93 \text{ cm}^2/\text{year}$  were obtained. In reality, the highest near-surface chloride content was measured to be at least  $16.8 \text{ kg/m}^3$  in the barrier wall, which is already quite higher than the maximum value of  $8.9 \text{ kg/m}^3$  suggested by Weyers (1998) for geographical regions with severe levels of exposure to deicing salts. Note that these guidelines were developed in the US and may not apply to regions like Canada or other northern countries, where more de-icing salts are used for longer winter periods. Similarly, the apparent chloride diffusion coefficient measured for the concrete barrier wall was found to be much larger than those obtained from the literature on similar concrete structures. For example, Figure 4-23 shows the predicted chloride profile using Equation 4 with a mean  $C_s = 7.4 \text{ kg/m}^3$  suggested by Weyers (1998) for severe exposure conditions, and  $D_c = 0.21 \text{ cm}^2/\text{year}$  measured by Dhir et al. (1990) on a concrete very similar to that used in this case study. It can be seen that the chloride profile is largely underestimated after

only ten years of salt exposure. These discrepancies can be explained by the large fluctuations of many factors influencing chloride ingress into concrete, including concrete mixture formulation, hydration and curing characteristics, temperature and humidity conditions, and surface chloride concentrations. It can be concluded that determining the chloride profile for a given concrete structure using carefully-selected literature values, even from apparently-similar concretes, can result in inaccurate estimations, thus resulting in poor predictions of the remaining service life of the structure.

Figure 4-24 presents the measured apparent surface chloride concentration over time, where it is shown that it increased significantly over time and reached a maximum value of  $23 \text{ kg/m}^3$  after 9 years. Figure 4-24 also presents the apparent chloride diffusion coefficient over time, where it is observed to decrease by a factor of 2 from Year 2 to Year 10. This could be explained in part by the continuing cement hydration and corresponding reduction in concrete porosity. Knowing that most chloride diffusion prediction models use constant values of  $C_s$  and  $D_c$ , the above observations suggest that simplified models may give inaccurate predictions if input values of  $C_s$  and  $D_c$  are not updated with field monitoring data.

Figure 4-24:  
Sensitivity analysis of time to  
rebar corrosion and time to  
concrete spalling

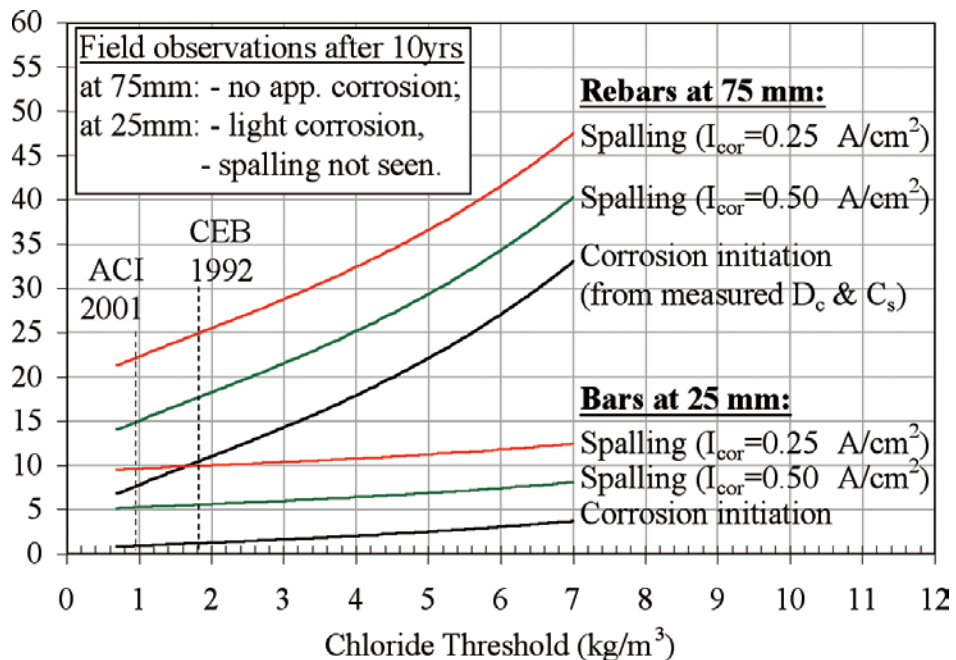

In order to predict the time of corrosion initiation ( $t_i$ ), Eq. 4 was rearranged by setting  $C(x,t)$  equal to a chloride threshold value ( $C_{th}$ ), at which steel corrosion can initiate, and  $x$  equal to the effective cover depth ( $d_c$ ). Assuming an elastic behavior for concrete in tension, stresses generated



by corrosion products were estimated using the thick-wall cylinder model (Bažant 1979, Lounis and Daigle 2008), which calculates the increase in rebar diameter  $\Delta d$  for each stage of corrosion-induced damage. The corrosion propagation times ( $t_p$ ), corresponding to the onset of internal cracking, surface cracking, and delamination/spalling were found as follows:

$$t_p = \frac{\rho_d \Delta d}{2 S j_r \left[ \frac{1}{r_r} - \alpha / r_s \right]} \quad (5)$$

*√f* Equation

where  $d$  is the rebar diameter;  $S$  is the rebar spacing;  $j_r$  is the rust production rate per unit area;  $\rho_r$  is the density of corrosion products (3600 kg/m<sup>3</sup> for Fe(OH)<sub>3</sub>);  $\rho_s$  is the density of steel (7860 kg/m<sup>3</sup>); and  $\alpha$  is the molecular weight ratio of metal iron to the corrosion product (0.52). The total time to reach a given corrosion-induced damage level is then found as the sum of the corrosion initiation time ( $t_i$ ) and the individual corrosion propagation times ( $t_p$ ) up to that level.

Figure 4-25 presents a sensitivity analysis of the times to initiate corrosion and concrete spalling, depending on several factors: (i) cover thickness; (ii) chloride threshold; and (iii) corrosion rate. At the 75 mm depth (location of main rebars), the prediction indicates a time to corrosion initiation between 6 and 10 years based on threshold values suggested by ACI and CEB. However, no significant corrosion was observed on sections of reinforcing bars cut from the barrier wall after 10 years (Cusson and Qian 2009).

Combined with the observation that the concrete surfaces over the 25-mm deep bars were still free of defects after 10 years (Cusson and Qian 2007), it seems that chloride threshold values larger than 2 kg/m<sup>3</sup> would be more appropriate in this case than the ACI and CEB values. In fact, the literature shows a strong disagreement amongst researchers on the range of values to use for the chloride threshold of conventional reinforcing steel in concrete (Alonso et al. 2000, Lounis and Daigle 2008). At a depth of 75 mm, the models predicted concrete spalling after 15 to 17 years of exposure, based on the commonly used corrosion rate of 0.50  $\mu\text{m}/\text{cm}^2$  and on the ACI and CEB chloride threshold values. Again, this event appears to be quite unlikely in this case. In fact, the average corrosion rates measured in the bridge barrier walls (near cracks) were 0.25  $\mu\text{m}/\text{cm}^2$  for the 75-mm deep reinforcement (and 0.30  $\mu\text{m}/\text{cm}^2$  for the 25-mm deep



Figure 4-25: CNR Bridge near Renfrew, Canada

test bars). With this field data, and assuming a chloride threshold larger than  $2 \text{ kg/m}^3$ , the models predict the onset of spalling after at least 25 years for the 75-mm deep bars, which appears to be a more appropriate prediction.

### Example 3: Health monitoring of concrete repair systems

This case study is presented to illustrate the use and benefits of structural health monitoring as a tool to evaluate the quality and durability of alternative repair methods.

To help address the need for a broadened knowledge base and new repair technologies, NRC and the Ministry of Transportation of Ontario (MTO) partnered in 1999 on a three-year project to field-test five proprietary commercial concrete repair systems (Cusson et al. 2006). The goal was to study the effectiveness of commercial concrete repair systems in preventing corrosion of steel reinforcement and shrinkage cracking of aging bridge decks. Testing took place on a highway bridge, near Renfrew (Ontario), as shown in Figure 4-26. Five proprietary commercial repair systems (including special concretes and corrosion inhibiting admixtures) and one control system of normal concrete were used to create a series of test patches on different sections of corrosion-damaged reinforced concrete barrier walls exposed to freeze-thaw cycles, wet-dry cycles and de-icing salt contamination. The 28-day compressive strength of these repair concretes ranged from 25 MPa to 50 MPa.

Figure 4-26:  
Location of sensors in typical  
test section

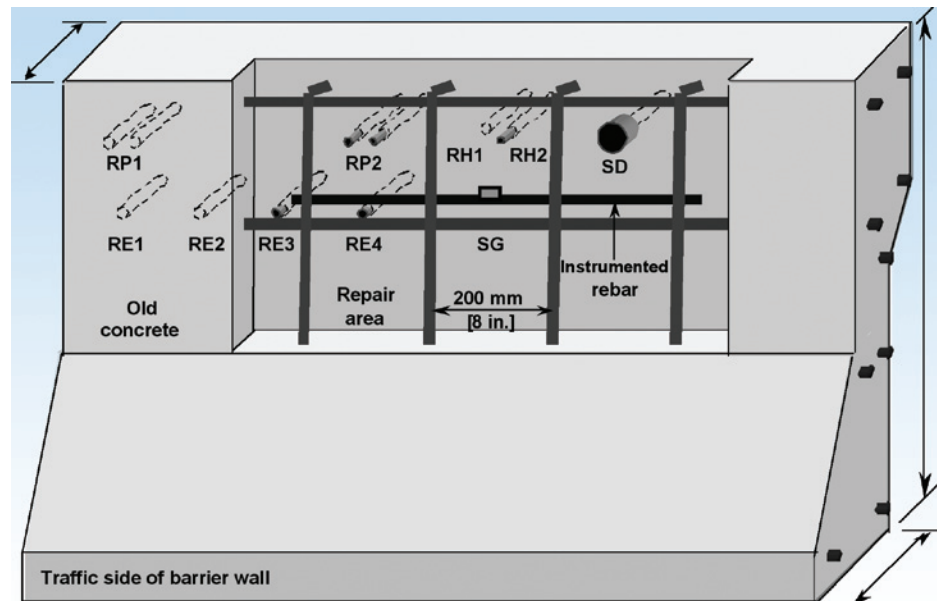

During the patching process, sensors were installed in the test sections and surrounding concrete (Figure 4-27).

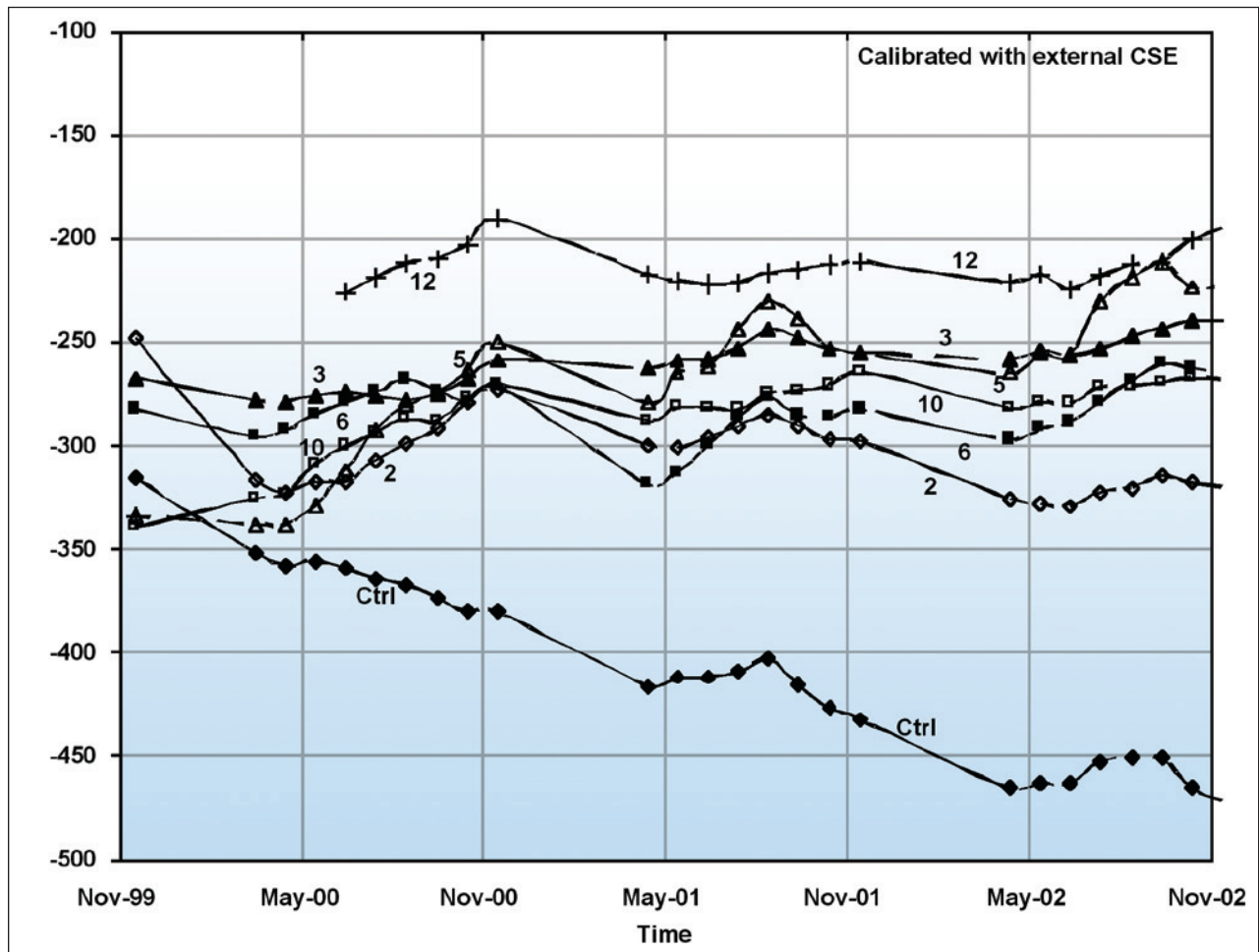

Figure 4-27: Corrosion potential in patches

Relative humidity (RH) sensors were used to assess the moisture gradient across the repaired section, which provided information on the moisture transfer between the patch and substrate, the risk of differential shrinkage, and the risk of freeze-thaw damage at the interface. The MnO<sub>2</sub> reference electrodes (RE) were used to detect a variation of the half-cell potential along the reinforcing bar going through both the repair and adjacent substrate, which provided information on macro-cell corrosion in the substrate. Strain gauges (SG or SD) were used to detect possible patch delamination if the strain patterns did not match. Electrical resistance probes (RP) were used to obtain additional data to support and complement the data obtained from the RH and RE sensors. The data acquisition system consisted of four data loggers equipped with a cellular modem for remote communication and powered by three car batteries, which were recharged by solar panels (Figure 4-27)

The findings indicate that the commercial proprietary repair systems performed slightly better in delaying corrosion when compared to control repairs made of normal concrete. Figure 4-28 shows the monthly average of the corrosion potential of the reinforcing steel measured in the patch on electrode RE4 (located 400 mm away from the old concrete). It is shown that the corrosion potential in the control section shifted towards more negative values, from  $-320$  mV to  $-470$  mV three years later, indicating an increased risk of reinforcement corrosion. In all other test sections, the corrosion potential in the patches remained practically unchanged with values between  $-200$  mV and  $-350$  mV, a range indicating that corrosion is uncertain according to ASTM C876.

The curves show that the corrosion potential of the old concrete in all test sections shifted towards more negative values by more than 100 mV within the three-year period. This is an indication that the risk of corrosion in the substrate has increased after the repair. Shrinkage cracking, however, was observed and detected by the strain gauges in all patches tested in this study, including the control patching system. It is believed that the delay in corrosion is significant enough to make the use of commercial proprietary concrete repair systems worthwhile, as long as the systems provide low water permeability, high electrical resistivity, and low shrinkage.

Figure 4-28:  
Corrosion potential in old  
concrete

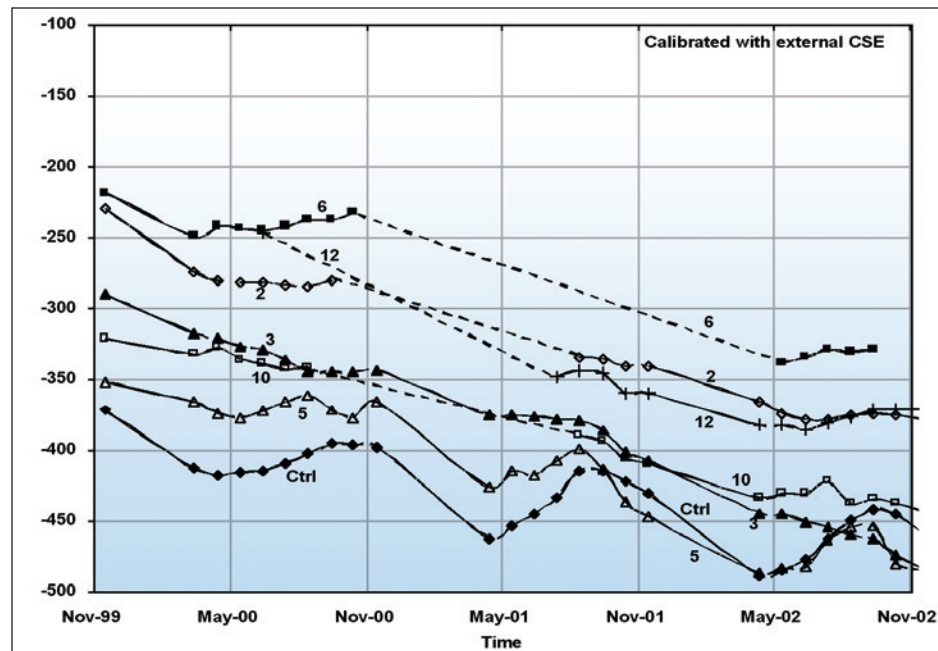

### 4.4.5 Discussion

Case study No. 2 showed that some of the input data that are commonly used in service life prediction models (e.g. surface chloride content, chloride diffusion coefficient, chloride threshold, and corrosion rate) could be very different from actual field values, because these parameters vary widely in time and location and are highly uncertain. Although the case study is on bridge barrier walls, the lessons learned also apply to other parts of a bridge as long as they show a bare concrete surface exposed to similar levels of chlorides, like a bare concrete deck.

In order to deal with the high variability and uncertainty of input data, two approaches could be used in combination. As mentioned before, structure health monitoring is one approach that can continuously provide valuable information on several key parameters simultaneously. For example, corrosion rates are usually ‘manually’ measured during the summer time for convenience, resulting in higher than yearly-average rates. This could result in overly conservative predictions of service life. On the other hand, remote monitoring of the corrosion rate with embedded instrumentation on a daily basis could provide a meaningful value of the yearly average, which can still be expected to increase as reinforcement corrosion and concrete deterioration develop over the years. The second approach is the use of probabilistic models accounting for this variability using average values and coefficients of variation of key parameters as well as their stochastic correlation in time and space (Lounis and Daigle 2008). Such models are more robust than deterministic models, and can be calibrated with SHM data.

### 4.4.6 Conclusions

This paper showed that the maintenance and protection management of aging critical bridges could be formulated as a multi-objective optimization problem. The obtained solutions achieved a satisfactory trade-off between several competing criteria, including the maximization of safety and security, and minimization of maintenance costs and minimization of traffic disruption. The use of proposed multi-objective criticality index can yield the optimal ranking of the critical bridge structures in terms of their priority for maintenance and protection. Different risk mitigation strategies can be implemented to improve the performance of critical bridges. Moreover, service life predictions of existing bridges could be significantly improved by updating the models with data from structural health monitoring.

#### 4.4.7 References

Almansour, H. and Lounis, Z. Structural Performance of Precast Prestressed Bridge Girders Built with Ultra High Performance Concrete, 2nd International Symposium on Ultra High Performance Concrete, Kassel, Germany, March 5-7, 2008, p. 823-830.

Alonso, C., Andrade, C., Castellote, M., Castro, P. Chloride threshold values to depassivate reinforcing bars embedded in a standardized OPC mortar, *Cement and Concrete Research*, 30(7), July 2000, p. 1047-1055.

Bažant, Z.P., Physical model for steel corrosion in concrete sea structures—theory. *Journal of the Structural Division*, 105(ST6), 1979, p. 1137-1153.

Cusson, D., Almansour, H., Lounis, L. and Daigle, L. Monitoring for durability and structural behavior of medium and long-span concrete bridges, 4th Intl. Conference on Structural Health Monitoring on Intelligent Infrastructure (SHMII-4) 2009, 22-24 July 2009, Zurich, Switzerland.

Cusson, D., Qian, S.: Ten-year evaluation of corrosion-inhibiting systems in concrete bridge barrier walls, *ACI Materials Journal*, Vol. 106, No. 3, May-June 2009.

Cusson, D., Qian, S., Hoogeveen, T.: Field Performance of Concrete Repair Systems on Highway Bridge, *ACI Materials Journal*, Vol. 103, No. 5, 2006, pp. 366-373.

Crank, J., The mathematics of diffusion, Second edition, Oxford University Press, London, 1975, 414 p.

Dhir, R.K., Jones, M.R., Ahmed, H.E.H., Seneviratne, A.M.G., Rapid estimation of chloride diffusion coefficient in concrete, *Magazine of Concrete Research*, Vol. 42, 1990, p. 177-185.

Duckstein, L. *Multiobjective optimization in structural design: The model choice problem*. New directions in optimum structural design, Atrek et al., eds., J. Wiley and Sons, N.Y. 1984, 459-481.

FHWA (1979 and 1996). *Recording and Coding Guide for the Structure Inventory and Appraisal of the Nation's Bridges*. Report no. FHWA-PD-96-001. Federal Highway Administration. U.S. Department of transportation.

FHWA, Florida Model Deployment Final Evaluation Report, Report No. FHWA-HOP-08-050, January 2009, 274 p.

Frangopol, D.M., Strauss, A., Kim, S., Bridge reliability assessment based on monitoring, *Journal of Bridge Engineering*, ASCE, May-June 2008, p. 258-270

Golabi, K., Thompson, P.D., and Hyman, W.A. *Pontis- version 2.0: Technical manual: a network optimization system for bridge improvement and maintenance*. Report FHWA-SA-93-031, 1993, Federal Highway Administration, Washington, D.C.

Hawk, H. Bridgit: user friendly approach to bridge management. Proc. 8<sup>th</sup> Intl. Bridge Management Conference, 1999, TRB-FHWA, Paper F-7.

Keeney, R.L., and Raiffa, H. *Decisions with Multiple Objectives: Preferences and Value Tradeoffs*. J. Wiley & Sons, New York, 1976.

Koski, J. Multi-objective optimization in structural design. In *new Directions in Optimum Structural Design*, Atrek et al., eds., Wiley, New York, 1984, pp. 484-503.

Lounis, Z., and Cohn, M.Z. Multi-objective optimization of prestressed concrete structures. *J. Struct. Engrg.*, ASCE, 1993, 119(3): 794-795.

Lounis, Z., and Cohn, M.Z. An engineering approach to multi-criteria optimization of highway bridges. *J. of Computer-Aided Civil & Infrast. Engrg.*, 1995, 10(4): 253-238

Lounis, Z., Daigle, L., Reliability-based decision support tool for life cycle design and management of highway bridge decks, Annual Conf. of the Transportation Association of Canada, Toronto, Sept. 2008, 19 p.

Lounis, Z. and Amleh, L. Reliability-based chloride ingress and reinforcement corrosion of aging bridge decks. In *Life Cycle Performance of Deteriorating Structures*, Frangopol, D. (eds.), 2003, pp. 113-122.

Melchers, R. E. *Structural Reliability- Analysis and Prediction*. Ellis Horwood Ltd, 1987, Chichester, England.

Mori, Y., and Ellingwood, B. Reliability-based service life assessment of aging concrete structures. *ASCE J. of Struct. Engrg.*, 1993, 119(5): 1600-1621.

Ministry of Transportation, Ontario. *Ontario Structure Inspection Manual (OSIM)*. Engineering Standards Branch, Bridge Office, MTO, 2000.

Mufti, A., *Guidelines for structural health monitoring*, ISIS Manual No. 2, 2001, [http://www.isiscanada.com/manuals/No2\\_contents.pdf](http://www.isiscanada.com/manuals/No2_contents.pdf).

Paté-Cornell, M.E. Quantitative safety goals for risk management of industrial facilities. *J. Structural Safety*, Vol. 13, 1994, pp. 145-157.

Starr, C. Social benefit vs. technical risk. *Science*, American Association for the Advancement of Science, Vol. 165, 1969, pp. 1232-1238.

Thompson, P.D., and Shepard, R.W. Pontis. *Transportation Research Circular 324*, Transportation Research Board, Washington, D.C., 1994, pp. 35-42.

Tuutti, K., The effect of individual parameters on chloride induced corrosion, in *Chloride Penetration into Concrete Structures*, L.-O. Nilsson (ed.), Göteborg, Sweden, 1993, p. 18-25.

Von Neumann, J. and Morgenstern, O. *Theory of Games and Economic Behavior*. Princeton University Press, 1947, Princeton.

Weyers, R.E., Service life model for concrete structure in chloride laden environments, *ACI materials Journal*, 95(4), July-August 1998, p. 445-453.

Zadeh, L.A. Optimality and non-scalar valued performance criteria. *IEEE Trans. Aut. Cont*, Vol. 8, No. 1, 1963, pp. 59-60.



# 5

# Advanced Methods For Evaluation



## In this chapter:

The papers in this chapter focus on a number of advanced methods health monitoring and diagnostics. These papers originate either as university research projects, both theoretical and experimental, or from private proprietary research and development. Evaluation of the state of infrastructure is essential, difficult, and uncertain. Typically, bridges and highways are evaluated by visual inspection on some regular schedule, but weaknesses in engineered structures may be invisible to the naked eye or may develop between inspection intervals.

These papers are highly technical, involving more sophisticated level of mathematics or a better understanding of detailed experimental processes than previous papers in this publication.

“The National Bridge Inventory (NBI) gives structural condition on a scale of 0 (failed) to 9 (new) while New York State Department of Transportation (NYS DOT) uses a scale 1 to 7. Unlike the NBI system, the final single number rating for the entire bridge re-

quires every structural component in every span to be rated in the NYS DOT system, with a weighted average combining the worst ratings of 13 key structural components throughout a bridge leading to the overall condition rating.” Testa et al., Paper 3.6)



The papers in this chapter focus on a number of advanced methods of health monitoring

and diagnostics. Evaluation of the state of infrastructure is essential, difficult, and uncertain. Typically, bridges and highways, for example, are evaluated by visual inspection on some regular schedule, but weaknesses in engineered structures may be invisible to the naked eye or may develop between inspection intervals.

“Fatigue is one of the primary degradation mechanisms that limit the life of structures constructed using metal components. Furthermore, cracks in metal components that result from fatigue may eventually grow to some critical length causing failure of the structure. When fatigue cracks grow to critical lengths in steel bridges the bridge either fails, is closed, or requires significant repairs to return it to normal service. The county’s aging bridges are littered with fatigue cracks. Currently, classifying fatigue cracks and prioritizing their repair is primarily completed with information gathered visually... According to a study commissioned by the Federal Highway Administration,

over 90% of these potentially dangerous cracks are missed through visual inspection.” (Moshier and Miceli, Paper 5.3)

“The multi-criteria aggregation is performed using the PROMETHEE method (Semaan, 2006). First of all, GSDM defines the Critical Threshold (CT) and the Tolerance Threshold. The Critical Threshold (CT) is the threshold beyond which a criterion is considered dangerous (or critical), whereas the Tolerance Threshold (TT) is the threshold below which a criterion is considered not dangerous at all (or tolerable). The Critical and Tolerance Thresholds (CT, TT) are represented by probability density functions. Hence,  $f(CT)$  would be the random variable of CT, and similarly  $f(TT)$  would be the random variable of TT. The definition of  $f(CT)$  and  $f(TT)$  is illustrated in Figure 5-71.” (Semaan and Zayed, Paper 5.8).

“Adhesive anchors been widely used in both new construction and repair/retrofit projects because of their rapid curing speed and economy. They are thus especially attractive for use in sustaining aging infrastructure. However, recent accidents have shown that current design procedure may not be safe...One of extreme cases was the ceiling collapse in the Interstate 90 connector tunnel in Boston, MA on July 10, 2006. A total [of] about 26 tons of concrete and associated suspension hardware fell down due to the poor creep resistance of the epoxy anchor adhesive system.” (Yin and Testa, Paper 5.7)

### **Paper 5.1 Centrifuge Modeling of Steel Piles Under Lateral Impact Loads**

*Hoe I. Ling, Logan Brant, Rene B. Testa, Raimondo Betti, and Andrew Smyth*

### **Paper 5.2 Digital Color Image Processing Methods for Assessing Bridge Coating Rust Defects**

*Sangwook Lee, Ph.D.*

### **Paper 5.3 The Electrochemical Fatigue Sensor (EFS)**

*Monty A. Moshier, Ph.D. and Marybeth Miceli*

### **Paper 5.4 Health Monitoring of Reinforced and Pre-Stressed Concrete Structures Using Time of Flight Information of Guided Waves**

*Tribikram Kundu, Tri Huu Miller, Tamaki Yanagita, Julian Grill, and Wolfgang Grill*

### **Paper 5.5 A Hierarchical Fuzzy Expert System for Risk of Failure of Water Mains**

*Hussam Fares and Tarek Zayed*

### **Paper 5.6 Integrated Condition Assessment Model and Classification Protocols for Sewer Pipelines**

*Fazal Chughtai and Tarek Zayed*

### **Paper 5.7 Strength Prediction for Adhesive Anchors: Elastic Analysis**

*H.M. Yin and R.B. Testa*

### **Paper 5.8 A Stochastic Diagnostic Model for Subway Stations**

*Nabil Semaan and Tarek Zayed*



Papers

## 5.1 Centrifuge Modeling of Steel Piles Under Lateral Impact Loads

*Hoe I. Ling, Logan Brant, Rene B. Testa, Raimondo Betti, and Andrew Smyth<sup>1</sup>*

### 5.1.1 Introduction

This paper summarizes the experimental observations obtained while studying the behavior of laterally loaded piles using Columbia University's centrifuge facility (Figure 5-1). An unusual component of this work involved the dynamic manner in which lateral loading was applied during many of these tests. This feature allowed models to simulate conditions occurring when a single free-head pile is subjected to a large horizontal impact force. In addition, many of the models were

constructed using fully saturated soil. Throughout these tests design parameters were varied allowing opportunities for comparisons.

The primary motivation for conducting this work was to investigate the response of piles subjected to lateral impact loading, an area of research which has not been extensively explored despite a critical need. Current design practices such as those recommended by the American Petroleum Institute (API 1993) focus on the design of deep foundations subjected to lateral loads applied in a static manner and to a lesser extent wave induced cyclic loading.

Applications of lateral impact loaded piles commonly occur in a marine environment making it important that this research also investigate the contribution from saturated soils in this soil-structure interaction. The analysis of saturated soils introduces complications especially when involving dynamic deformations. Rapid changes to saturated soil may cause pressure within the pore fluid to increase. Soils with low hydraulic conductivity obstruct the flow of pore fluids causing un-drained conditions.



Piles are employed in many applications to absorb and deflect lateral impact loads. Structural elements of this type are commonly used in water environments, such as in bridge piers and foundations, to protect them from vessel impact. A series of model tests was conducted using Columbia University's centrifuge facility to better understand the performance of piles subjected to these loading conditions. A device was designed to install and laterally load model piles during centrifuge flight. This device uniquely contained two lateral loading systems, one that allowed static testing and another appropriate for dynamic tests. This research examined the behavior of tubular steel piles embedded in dry or saturated soil and subjected to varied rates of lateral loading, and also provided insight on the contribution of lateral loading rates to the behavior of piles.

**INFRASTRUCTURE TYPE:** Steel piles

<sup>1</sup> Department of Civil Engineering and Engineering Mechanics, Columbia University, New York, NY 10027. E-mail: Ling@civil.columbia.edu.

### 5.1.2 Scaling Laws and Properties

Centrifuge modeling in conjunction with limited full-scale field validation can provide a cost effective alternative to testing only full scale structures in situations where reliable soil-structure interactions are uncertain. This tool allows the capability to tailor experiments to specific design criteria. In geotechnical engineering, the body forces within the soil are important when defining how an underground structure will perform. In order to create representative soil models it is critical that body forces within the soil be scaled appropriately.

The use of a geotechnical centrifuge allows scaling of stresses imposed by the soils own weight by varying the acceleration field in which the model is located. When properly constructed, reduced scale centrifuge models represent conditions existing in full scale prototype structures. Table 5-1 contain the relevant centrifuge scaling relationships.

Centrifuge modeling in conjunction with limited full-scale field validation can provide a cost effective alternative to testing only full scale structures in situations where reliable soil-structure interactions are uncertain.



Figure 5-1:  
Centrifuge Facilities, Columbia  
University

Table 5-1: Relevant Centrifuge Scaling Relations

Quantity	Prototype	Model
Length	1	1/N
Area	1	1/N <sup>2</sup>
Volume	1	1/N <sup>3</sup>
Acceleration	1	N
Force	1	1/N <sup>2</sup>
Stress	1	1
Strain	1	1
Dynamic Time	1	1/N
Diffusion Time	1	1/N <sup>2</sup>

During centrifuge modeling conflicting Relations scaling relationships exists when water is used as a pore fluid. To correct for this discrepancy centrifuge modeling of water saturated prototypes requires the use of a substitute pore fluid with density similar to water, but with a viscosity increased proportionally with the scaled centrifugal acceleration. The use of a substitute pore fluid compensates for the difference in scaling relations which then allows dynamic time and diffusion time events to occur at a similar rate, with model speeds occurring N times faster than those found in the prototype.

Replacing prototype soils with scaled model soils would require the reduction of soil grain diameters, however that would likely result in soils with very different physical properties. The same soil types found in the prototype are typically used when constructing centrifuge models. This presents challenges when shear banding or soil dilation cause changes which are not proportional to the scaled dimension of the model. Generally if the ratio of the pile diameter divided by the mean soil diameter is kept large particle size effects are minimized during this type of soil-structure interaction. In these experiments the ratio of DPILE to D50 was equal to 85.

### 5.1.3 Soil, Pile, and Fluid Properties

In the field piles are constructed from a range of materials including, structural steel, reinforced concrete, timber, and plastics. These materials each have their own distinct characteristics. A model pile should match closely the properties of the prototype pile material being studied, which in this case was structural steel. T316L stainless steel was used as the material for the model piles because of its similarities to the properties of

A36 structural steel (Table 5-3). In addition, stainless steel is non-corrosive and is available in a wide range of sizes.

Nevada Sand was selected as the soil used in these models because of its well researched material properties (Table 5-2). No. 120 Nevada Sand is relatively fine poorly graded sand. Published results report the hydraulic permeability of water through Nevada Sand as  $2.3 \times 10^{-5}$ ,  $5.6 \times 10^{-5}$  and  $6.6 \times 10^{-5}$  m/sec for soils with relative densities of 91.0, 60.1, and 40.2 percent respectively (Arulmoli et al., 1992).



Nevada Sand was selected as the soil used in these models because of its well researched material properties.

**Table 5-2: Nevada Sand Soil Properties (Arulmoli et al., 1992)**

Specific Gravity	2.67
Max. Dry Unit Weight	17.33 kN/m <sup>3</sup>
Min. Dry Unit Weight	13.87 kN/m <sup>3</sup>
Max. Void Ratio	0.887
Min. Void Ratio	0.511
D50	0.00015 m

**Table 5-3: Typical Scaled Pile Properties**

Model (40g)	Prototype (1g)
T316 Stainless Steel	A36 Structural Steel
E = 193 GPa	E = 200 GPa
$\sigma_{YIELD} = 290$ MPa	$\sigma_{YIELD} = 250$ MPa
$\sigma_{ULT} = 580$ MPa	$\sigma_{ULT} = 400$ MPa
D = 0.0127 m	D = 0.508 m
$L_{EMB} = 0.2032$ m	$L_{EMB} = 8.13$ m
EI = 93.2 Nm <sup>2</sup>	EI = 247.2 MNm <sup>2</sup>

A fluid mixture containing Metolose and water was used as a substitute pore fluid because it has properties when scaled to prototype conditions that simulate water saturated soil within the model. This fluid solution has density similar to water (1000 kg/m<sup>3</sup>) but with viscosity of 40 cps, a value which is 40 times greater than that of water.

### 5.1.4 Experimental Procedures

To facilitate this work an elaborate testing device was created allowing experiments to be conducted on the arm of the centrifuge. The purpose of this equipment was to install and laterally load single model piles during centrifuge flight. This device uniquely contains two lateral loading systems, one which allowed static testing and another which created dynamic impact loads (Figures 5-2a and 5-2b). Numerous challenges were encountered during the design of this system, including the requirement that all components be capable of operating while subjected to large accelerations. The system was controlled remotely with the operator safely removed from the centrifuge chamber.



To facilitate this work an elaborate testing device was created allowing experiments to be conducted on the arm of the centrifuge.

Video signals, AC power, and electrical controls were transmitted to and from the centrifuge using electrical slip rings. Fluid joints allowed pressurized hydraulic fluid to enter the rotating centrifuge. An onboard data logger was used to collect signals

from numerous sensors while a wireless router mounted on the centrifuge transmitted this information to a computer located outside of the centrifuge chamber. The wireless system ensured experimental data of the highest quality was obtained in real time.

The piles were typically assembled from stainless steel tubes ( $D = 1.27$  cm and  $T = 0.71$  mm) cut to a length of 26.0 cm (Figure 5-2a). Along one side of the model pile 8 quarter bridge strain gages were attached at equally spaced intervals. The lowest was placed 2.54 cm above the pile tip and the highest at a distance of 20.32 cm, which corresponded to the fully embedded piles depth. A coating of epoxy 1 mm in thickness was applied to the exterior surface of the pile to provide the strain gages with protection from water and mechanical damage. Each experiment required the construction of a new model pile.

Homogenous soil specimens were created using an automatic sand hopper (Figure 5-2b). This machine moved back and forth at a constant rate raining sand into the soil box while an operator raised the hopper to maintain a constant drop height. This device has been used to prepare uniform horizontal soil deposits in previous centrifuge studies (Ling et al., 2003). To achieve fully saturated soil specimens pore fluid was added to the soil while a vacuum pressure of 70 kPa was maintained within the covered soil box. This step was necessary for the removal of trapped gases within the soil, an important part of the process required to obtain fully saturated soil specimens.



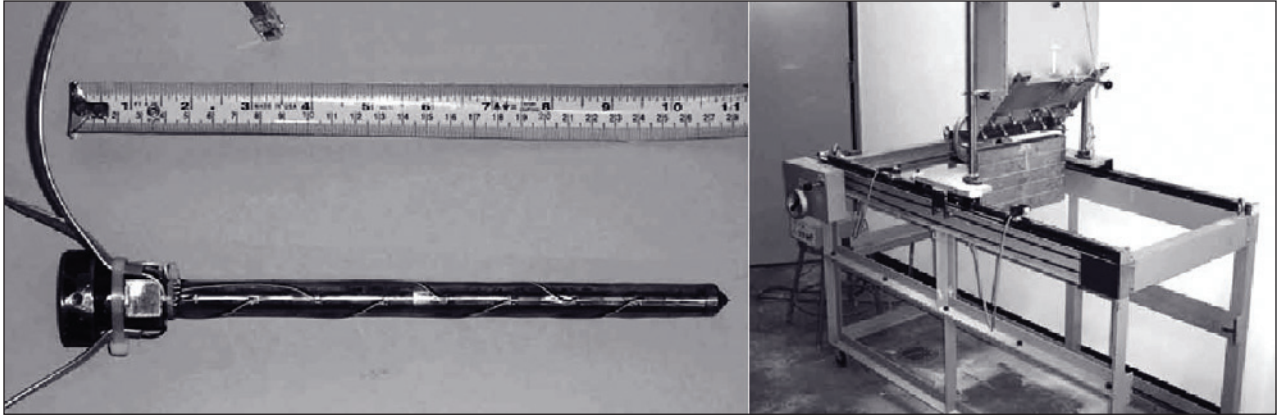

Figure 5-2: (a) Model pile with closed tip (left) and (b) automatic sand hopper (right)

The testing procedure itself consisted of two phases. The first utilized a motor driven displacement controlled system to uniformly push the model pile vertically into the soil at a constant rate of 0.3 mm/s. During installation sensors including a load cell, a displacement transducer and strain gages recorded the response of the pile. When the pile was fully embedded to a depth of 20.32 cm the mechanism driving the pile was stopped. The pile was released by disconnecting the electromagnet which had previously held the head of the pile during installation. The driving mechanism was then raised separating it from the pile and allowing the next phase of the experiment to begin.

This second phase was the most critical portion of this research. Vertically oriented model piles were subjected to horizontal loads applied at a height of 5.1 cm above the soil. The applied force acting on the pile or similarly the equal but opposite resistance supplied by the pile was measured by a force transducer mounted on the lateral loading mechanism. Two displacement transducers were employed to measure the rotation and displacement of the free head pile during loading (Figure 5-3). Several experiments were equipped with pore pressure transducers placed within the soil to record pore fluid pressure changes that occurred at specific locations as a result of the dynamic deformations.

A unique feature of this device was that the applied horizontal force could be supplied from two different loading systems. One system involved a motor driven displacement controlled mechanism which applied loads extremely slowly at  $1.7 \times 10^{-5}$  m/s, simulating static loading conditions. The other was driven by a hydraulic piston capable of completing the loading within tens of milliseconds, creating a rapid impact condition with a displacement rate of 0.8 m/s. Using this dynamic



A unique feature of this device was that the applied horizontal force could be supplied from two different loading systems.

system the maximum displacement of the pile head was controlled by the placement of the pile relative to the hydraulic piston with a maximum stroke limited to 8 cm. Both of these mechanisms were displacement controlled systems despite differences in their mechanical design and rate of displacement.

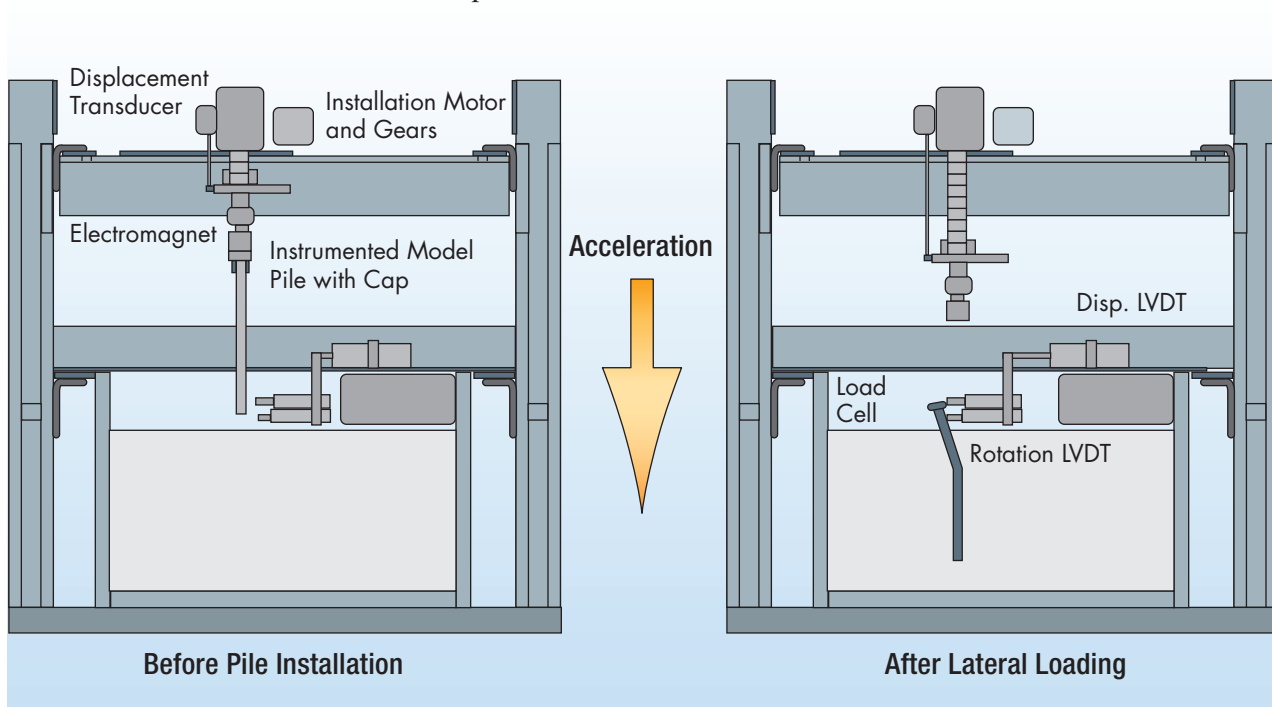

Figure 5-3: Testing Device

### 5.1.5 Results and Observations

Extensive instrumentation was used to measure behaviors occurring during these laterally loaded model pile experiments. This paper presents a number of observations presented using graphs describing lateral pile resistance as a function of the pile head deflection. Other examples highlight interesting behaviors and demonstrate the variety of measurements obtained during these centrifuge tests. The scope of this paper restricts the quantity of material that may be presented. Values described in this paper reflect conditions measured during the model tests and have not been scaled to represent prototype values.

**Rate of Loading** - These experiments demonstrated that increases in the rate of applied loading caused the model piles to provide greater lateral resistance. Tests conducted using Nevada Sand with relative density,  $D_r$  of 80 percent showed increased resistance of 10 percent for dry sands and an increase of 35 percent when using fully saturated soil. Models constructed using saturated soil, but with piles 50 percent stiffer ( $EI = 143.1 \text{ Nm}^2$ ) than the previous piles showed an increased resistance of 60

percent when comparing impact loading to static loading. Differences in soil response which may have contributed to these rate dependent behaviors are discussed later.

Table 5-4: Testing Summary

Test No.	Dr %	Pore Fluid	Duration sec	Disp m	Rate m/s	Lateral Max, N	Lateral Res, N	% Decrease	Install Type	Install Max, N	Tip Cond.	Pile T mm
4	80	Dry	0.062	0.0495	0.80	680	480	29.4	40g	N/A	O	0.71
5	80	Dry	0.064	0.0515	0.80	700	500	28.6	1g	N/A	O	0.71
6	80	Dry	1420	0.0245	1.7E-5	540	-	-	40g	N/A	O	0.71
7	80	Dry	1750	0.0300	1.7E-5	550	-	-	40g	N/A	O	0.71
8	80	Dry	2100	0.0360	1.7E-5	550	-	-	40g	N/A	C	0.71
9	80	Dry	2100	0.0360	1.7E-5	530	-	-	40g	N/A	O	0.71
20	80	Met	1450	0.0235	1.6E-5	560	-	-	40g	3600	O	1.24
21	80	Met	1400	0.0225	1.6E-5	510	-	-	40g	3400	O	0.71
23	50	Met	1550	0.0265	1.7E-5	440	-	-	40g	1120	C	0.71
24	50	Met	1500	0.0260	1.7E-5	410	-	-	40g	1110	O	0.71
26	80	Met	0.048	0.0350	0.73	N/A	N/A	N/A	40g	2650	O	0.71
27	80	Met	0.050	0.0375	0.75	940	750	20.2	40g	N/A	O	1.24
28	80	Met	0.052	0.0380	0.73	870	720	17.2	40g	2650	C	0.71
29	80	Met	1230	0.0225	1.8E-5	N/A	-	-	40g	3200	O	0.71

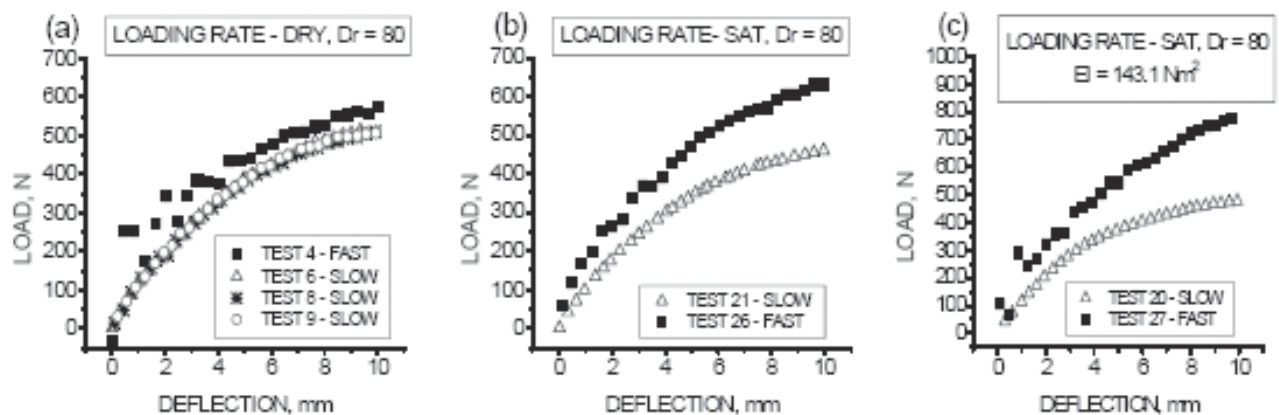

Figure 5-4: Pile Response Subjected to Varied Loading Rates

When measuring conditions occurring during dynamic loading the presence of inertial forces can create a challenge.

When measuring conditions occurring during dynamic loading the presence of inertial forces can create a challenge. Inertial forces occurred during impact loading when the pile was accelerated from rest. These forces are different from those caused by the resistance from the soil-structure interaction. Distortions caused by the presence of inertial

forces were intentionally minimized by applying the dynamic loading at a nearly constant rate. Horizontal accelerations remained near zero during most of the loading period. Large accelerations occurred for relatively short lengths of time at the beginning and at the end of the impact loading while producing negligible interference during the remainder of the loading. Unavoidable inertial forces were responsible for inconsistencies immediately following the initial impact. This is shown in Figures 5-4. Inertial resistance created a large spike at the time of impact followed by several decaying oscillations. Increased damping of these vibrations were observed in the tests which involved fully saturated soil (Figures 5-4b and 5-4c) as opposed to dry soil (Figure 5-4a).

**Pore Fluid**— Tests were conducted in Nevada sand with  $D_r$  of 80 percent in soil that was either dry or fully saturated using a substitute pore fluid. When subjected to static loading conditions the dry soil provided lateral resistance 15 percent greater than that provided by the fully saturated soil (Figure 5-5). This could be explained by the decreased effective unit weight of the saturated sand which subsequently caused decreased passive earth pressure to act horizontally against the pile. With  $\gamma_{dry} = 16.5 \text{ kN/m}^3$  and  $\gamma' = 10.3 \text{ kN/m}^3$  it might be expected that this variation in capacity would be even greater, however other factors also contribute to the passive earth pressure within the soil. Model piles subjected to dynamic impact loading provided a lateral resistance 10 percent larger when embedded in saturated soil compared to models constructed using dry soil.

Figure 5-5:  
Pile Response Subjected to  
Varied Loading Rates in Dry  
and Saturated Soil Deposits

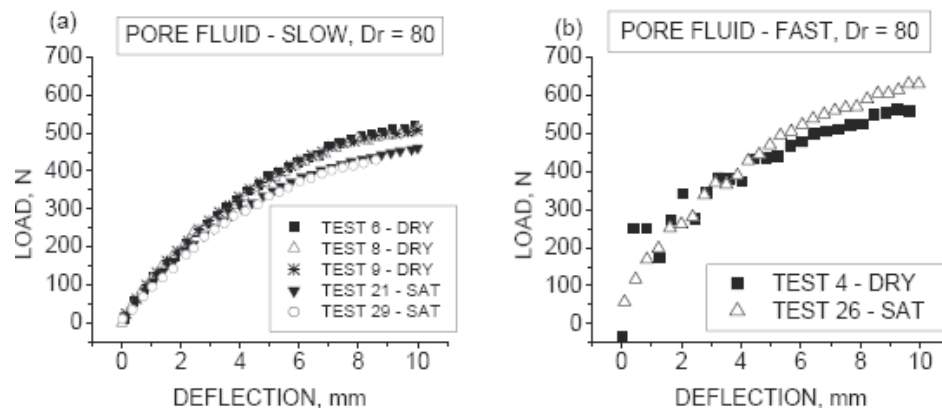

Pore pressure transducers were incorporated into several of the models to directly measure changes occurring in the pore fluid pressure during impact loading (Figure 5-6). This transducer was located within the fully saturated soil with  $D_r$  of 80 percent at a depth of 5.1 cm and 2 cm in front of the instrumented pile. Figure 5-7 shows measurements obtained during test number 15 which demonstrate changes in the pore pressure occurring during lateral impact loading. A temporary pore fluid pressure decrease of 15 kPa occurred at this location. The dense sand likely underwent some degree of dilation when subjected to these loading conditions. The at-rest hydrostatic pressure in this location was 20 kPa and the total vertical stress was 40.5 kPa.

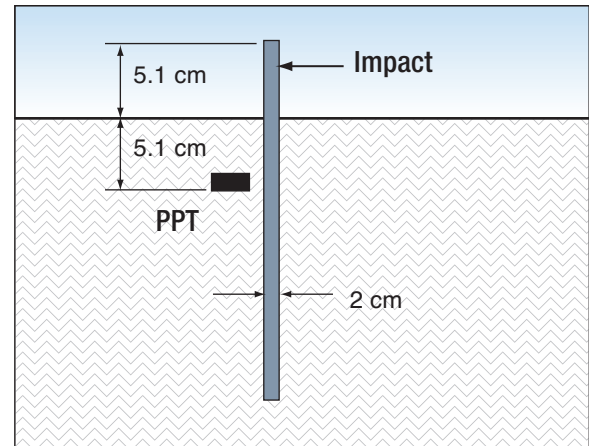

Figure 5-6: PPT Location

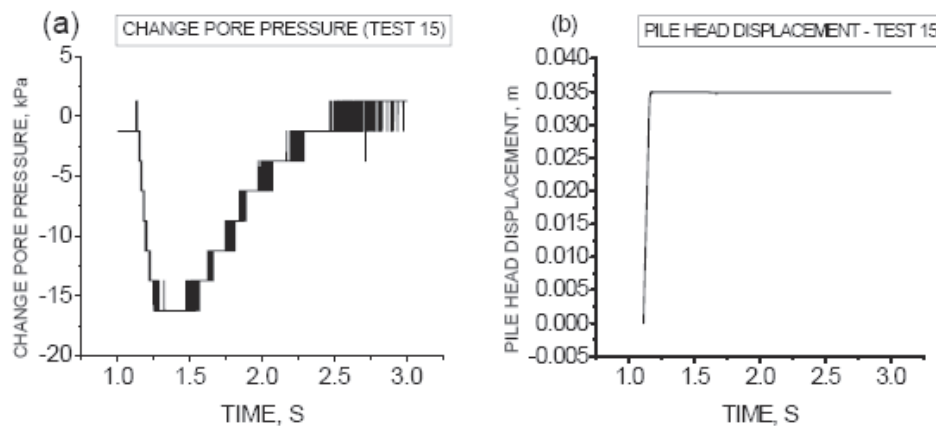
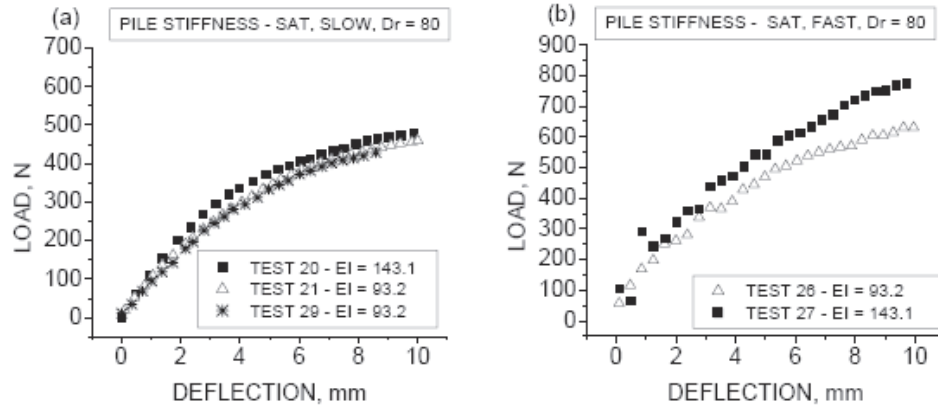

Figure 5-7: Relationships between Changes in Pore Pressure and Pile Cap Displacement vs. Time.

**Tip Condition**— Most model piles were constructed from tubular steel pipe which was left open at the tip. As an alternative several model piles were given a conical insert that was tapered at 45 degrees providing a solid closed pile tip. It was observed that the open tipped piles became plugged during installation and at a shallow depth began producing a behavior similar to that of the solid cone shaped tip.

**Pile Stiffness**— Tests involving fully saturated soil with  $D_r$  of 80 percent were used to compare the lateral resistance provided by model piles with bending stiffness's ( $E_p I_p$ ) of  $93.2 \text{ Nm}^2$  and  $143.1 \text{ Nm}^2$  respectively. When subjected to static loading an increase in lateral resistance of only 5 to 10 percent occurred when using the stiffer pile. When the model piles were subjected to dynamic impact loads the stiffer pile provided 20 percent greater lateral resistance under dynamic impact loading conditions (Figure 5-8).

Figure 5-8:  
Graphs Showing Effects of  
Varied Pile Stiffness (EI)



**Installation Acceleration**— Similar responses were observed comparing two tests with dry soil having  $D_r$  of 80 percent that were subjected to lateral impact loading when one pile was installed under an acceleration of 40g during centrifuge flight and the other was installed at 1g prior to centrifuge spinning. This comparison showed that in-flight pile installation may not be necessary when studying lateral impact loading.

### 5.1.6 Sampling Of Other Results

**Bending Moment vs. Depth (Elastic)**— Figure 5-9 shows snapshots of bending moment distributions at successive increments of time while the internal forces within the pile remained within the elastic stress range. Bending moment measurements provide valuable descriptions of a pile's response and may be used to create load-transfer functions.

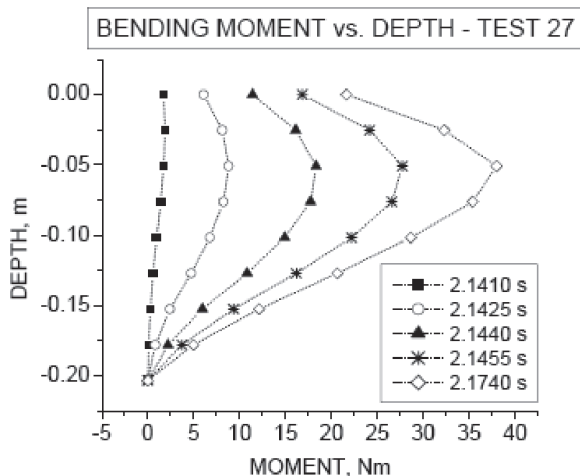

Figure 5-9:  
Bending Moment vs. Depth

**Deformed Pile Shape**— The deformed shape of a pile may help to determine the location within the pile where the plastic hinge developed. This understanding is relevant when investigating the behavior of this type of soil-structure interaction. Table 5-5 provides a summary of the locations where plastic hinges developed on the pile due to extreme loading. In general model piles subjected to impact loading and embedded in saturated soil develop a plastic hinge located closer to the surface of the soil. In dry soils this characteristic did not significantly vary regardless of the loading type.

Table 5-5: Deformed Pile Shape Summary

Test No.	4	7	26	29	27	20	24	28
Parameter Type	Dry Fast	Dry Slow	Sat Fast	Sat Slow	Sat Fast EI = 143	Sat Slow EI = 143	Sat Slow $D_r = 50$	Sat Fast Closed
Depth to Hinge, m	0.066	0.057	0.051	0.072	0.051	0.074	0.076	0.050
Depth to Hinge, %	32.5	28.1	25.0	35.6	25.0	36.3	37.5	24.4

**Force vs. Time**— There are interesting behaviors not clearly portrayed by graphs showing the force vs. displacement measurements recorded during these experiments. Piles subjected to lateral impact forces showed an increased horizontal resistance relative to the response when subjected to static loads. During the dynamic portion of the impact loading increased resistance was observed. When the displacement causing the dynamic loading was stopped the resistance provided by the pile fell by 20 to 30 percent. In the period that followed while the lateral force was maintained but the displacement rate was equal to zero the loading type became static. At this stage the lateral resistance provided by the pile became approximately consistent with the ultimate lateral capacity measured during the static load tests. This behavior was observed in both dry and fully saturated soils.

Figure 5-10 presents force vs. time and displacement vs. time graphs showing results from experiments numbers 4 and 7. These tests were conducted using dry Nevada sand with  $D_r$  of 80 percent. The model properties used during these tests only varied in the manner with which the lateral load was applied to the head of the pile.

There were contrasts observed during these experiments resulting from differing responses due to changes in the rate of applied load. Densely packed sand such as that used in these models generally underwent dilation (Figure 5-11). Large vertical and horizontal pressures constraining this soil made it difficult for the soil volume to increase. The soils attempt to increase volume was resisted causing increased pressures within the soil. This pressure over time would dissipate and redistribute within the surrounding soil. Soil deformed at a slow rate had sufficient time for pressures within the soil to equilibrate by deforming the surrounding material. When piles were rapidly displaced localized pressures within the soil were not able to redistribute. These pressures subsided only after the dynamic loading was stopped. It has been observed that piles subjected to impact loads provide greater lateral resistance while dynamic loading occurred, however when the displacement stopped this measured resistance significantly dropped. This behavior may explain the different responses which occurred when comparing the static and dynamic loaded piles embedded in both dry and fully saturated soils.

Figure 5-10:  
Examples of Force vs. Time &  
Displacement vs. Time Graphs

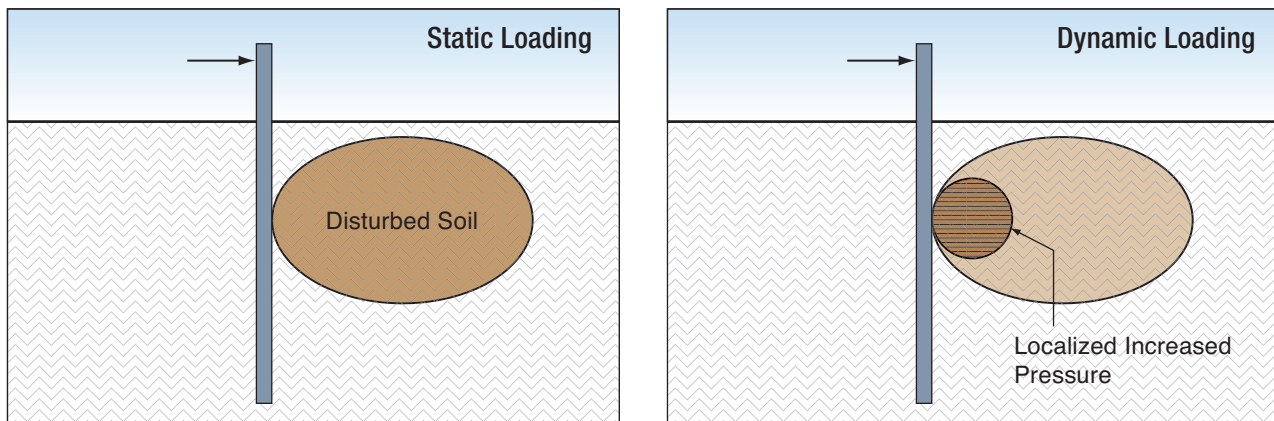
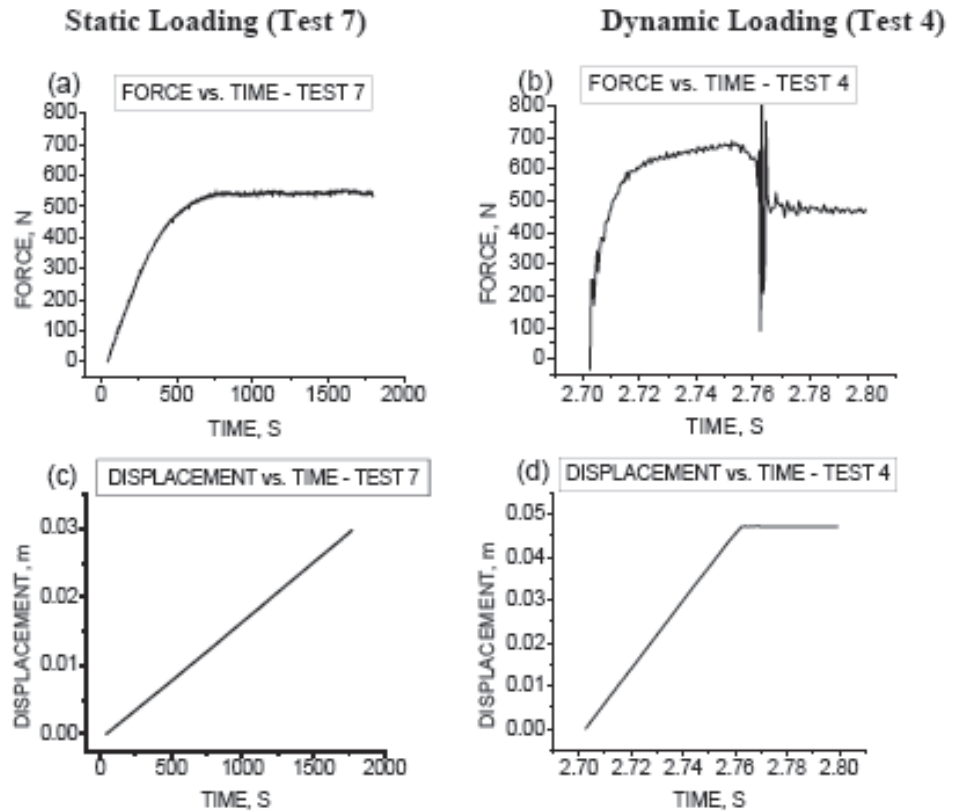

Figure 5-11: Differences in effected soil region caused by loading conditions



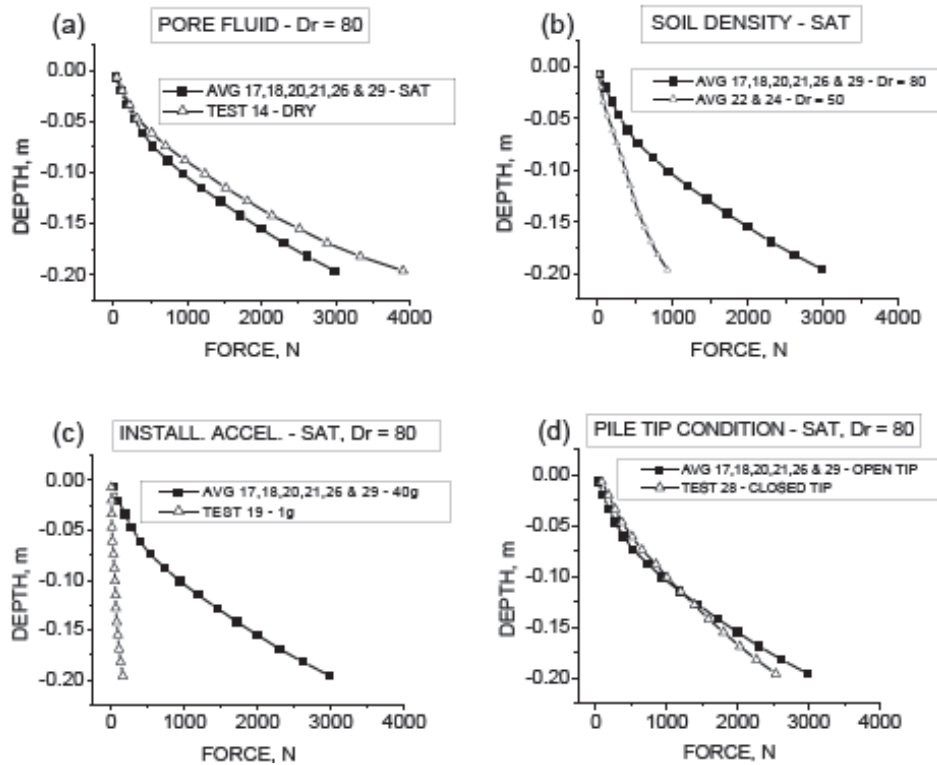

Figure 5-12:  
Axial Pile Resistance vs.  
Embedment Relationships

**Axial Resistance**— A displacement controlled mechanism which provided a constant rate of embedment of 0.3 mm/s was used to drive the model piles. Throughout these series of tests parameters were varied including; soil density, pore fluid, and pile tip condition. A comparison was made relating the axial resistance provided when the model was under Earth's gravity (1g) and when it was exposed to large centrifuge imposed accelerations (40g). Figures 5-12a to 5-12d compare measurements obtained during installation and provide insight into the contribution from each studied parameter on the effect it had on the axial capacities provided by the pile. This information may be important because the tip resistance measured during installation is likely related to other properties contributing to the behavior of laterally loaded piles.

Strain measurements recorded during pile installation show the breakdown of the total axial tip resistance. Strains measured along the pile were directly proportional to the axial stresses at those locations. It was observed that the stresses were nearly constant over the length of the pile. This allows a conclusion that nearly all of the resistance. Figure 5-13 shows strain vs. embedment -measurements recorded at 8 locations spaced over the length of a pile. The purpose of this figure is to show that these 8 measurements were similar. A greater contribution from skin friction would have resulted in stresses along the pile decreasing with depth. Skin friction did not contribute to the capacity of these piles because the

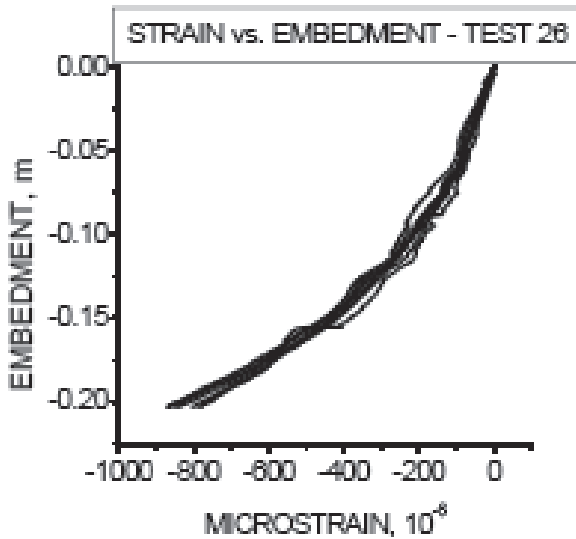

Figure 5-13: Strain vs. Embedment

sand used within these models offered little cohesive strength and the smooth epoxy coating on the pile provided a low angle of friction between the epoxy and the sand.

### 5.1.7 Conclusions

There is a wealth of information available through the use of centrifuge modeling of piles subjected to lateral loads. The material presented in this paper provides a sampling of what was achieved after only a few dozen model test. When thoughtfully constructed centrifuge modeling offers a tool capable of studying a range of important subjects. The most important conclusion offered by this paper is the evidence that the manner and rate with which lateral loading is applied significantly affects the response of a pile. When a single horizontal impact load was applied to a model pile with these specific soil and pile properties the pile provided increased lateral resistance compared with its response from static loading. It may be concluded that traditional design procedures for calculating the response of piles under static loading may offer conservative estimates of the resistance that a pile would provide if subjected to a single dynamic impact. This conclusion applies to the specific conditions found in these models and to the related scaled prototype, but should not without further investigation be interpreted as generally applicable to all other lateral impact loaded piles.



When thoughtfully constructed centrifuge modeling offers a tool capable of studying a range of important subjects.

### 5.1.8 References

API RP 2A-WSD (1993), *Recommended Practice for Planning, Designing and Constructing Fixed Offshore Platforms - Working Stress Design*, 20th Ed., Washington, American Petroleum Institute, 65-67.

Arulmoli, K., Muraleetharan, K. K., Hossain, M. M., and Fruth, L. S. (1992). "VELACS: Verification of liquefaction analyses by centrifuge studies, laboratory testing program, soil data report." Project No. 90-0562, The Earth Technology Corporation, Irvine, Calif.

Chang, Y.L. (1937). "Chang on Lateral Pile-Loading Tests." *Transaction of the American Society of Civil Engineers*, v.102, 272-278.

Grundhoff, T., Latotzke, J., & Laue, J. (1998) "Investigation of Vertical Piles Under Horizontal Impact." Centrifuge 98, Rotterdam: Balkema, 569-574.

Hetyenyi, M.I. (1946). *Beams on Elastic Foundation; Theory with Applications in the Fields of Civil and Mechanical Engineering*. Ann Arbor: The University of Michigan press.

King, G.J.W. (1994). "The Interpretation of Data from Tests on Laterally Loaded Piles." Centrifuge 94, Rotterdam: Balkema, 515-520.

Kusakabe, O. (1995). "Foundations," *Geotechnical Centrifuge Technology*, Ed. R.N. Taylor, Blackie Academic & Professional, 118-167.

Ling, H.I., Mohri, Y., Kawabata, T., Liu, H., Burke, C., and Sun, L. (2003). "Centrifugal Modeling of Seismic Behavior of large-Diameter Pipeline in Liquefiable Soil." *Journal of Geotechnical and Geoenvironmental Engineering*, ASCE, 129(12), 1092-1101.

Matlock, H. & Reese, L.C. (1960) "Generalized Solutions for Laterally Loaded Piles." *Journal of the Soil Mechanics and Foundations Division*, ASCE, 86(5), 63-91.

Phillips, R. (1995). "Centrifuge modelling: practical considerations." *Geotechnical Centrifuge Technology*, Ed. R.N. Taylor, Blackie Academic & Professional, 34-60.

Poulos, H. G. & Davis, E. H. (1980). *Pile foundation analysis and design*. New York: Wiley.

Reese, L.C. (1977). "Laterally loaded piles: Program documentation." *Journal Geotechnical Engineering Division*, ASCE, 103(4), 287-305.

Reese, L.C. (1983). "Behavior of piles and pile groups under lateral load." Rep. to the

U.S. Dept. of Transportation, Federal Highway Administration, Office of Research, Development, and Technology, Washington, D.C. Taylor, R.N. (1995). "Centrifuge modelling: principles and scale effects." *Geotechnical*

*Centrifuge Technology*, Ed. R.N. Taylor, Blackie Academic & Professional, 19-33 Tsinker, G.P. (1997). *Handbook of Port and Harbor Engineering: Geotechnical and Structural Aspects*. New York: Chapman & Hall

## 5.2 Digital Color Image Processing Methods for Assessing Bridge Coating Rust Defects

*Sangwook Lee, Ph.D.<sup>2</sup>*

### 5.2.1 Introduction

**D**igital image processing has been applied to diverse industry disciplines. Recently, in the civil engineering domain, digital image recognition methods have been utilized in, but not limited to,

steel bridge coating inspection, underground pipeline and pavement condition assessments, and construction material inspections. The wide application of digital image processing can be attributed to the following advantages: accuracy, objectivity, speed, and consistency. These distinct advantages will facilitate existing inspection methods to be replaced or supplemented by advanced infrastructure inspection methods.

For instance, the conditions of steel bridge painting surfaces can be evaluated accurately and quickly by applying digital image processing. Also, machine vision-dependent inspections can provide more consistent inspection results than human visual inspections. Conventional inspection results can be highly dependent on personal preferences, familiarity with the work, or the workload of the inspectors. Reliable coating condition assessment methods are necessary so that bridge managers can develop long-term cost-effective maintenance programs and make decisions as to whether a bridge shall be completely or partially repainted immediately or later. With these goals in mind, digital image recognition methods have been developed for objective rust defect recognition in the past few years. Rust defects are one of the most commonly observed defects on coating surfaces and can severely affect the structural integrity of bridges.



An accurate, objective rust defect assessment of a steel bridge surface is required to maintain good quality steel

bridge coating and make a decision whether a bridge should be repainted partially or completely. Digital image recognition methods have been developed over the past few years for more objective rust defect recognition, and they are expected to replace or complement conventional painting inspection methods. Efficient image processing methods are also essential for the successful implementation of steel bridge coating warranty contracting, where the owner, usually a state agency, and the contractor inspect steel bridge coating conditions on a regular basis and decide whether additional maintenance actions are needed based on the processed data.

This paper presents a digital color image processing method for evaluating bridge coating surface conditions.

**INFRASTRUCTURE TYPE:** Bridges

<sup>2</sup> Assistant Professor, Department of Engineering Technology, College of Engineering, Texas Tech University, Lubbock, TX 79409, USA. E-mail: goswlee@yahoo.com, Phone: 806.742.3538.

Efficient rust defect recognition methods are also essential for the successful implementation of steel bridge coating warranty contracting where the owner, usually state agencies, and the contractor inspect steel bridge coating conditions on a regular basis and decide whether additional maintenance actions are needed. Indiana Department of Transportation (INDOT) has tentatively set up the maximum warranty period of five years and the maximum allowable rust percentage of 0.3% within a total steel structure. If the painting rust defect percentages on steel bridge surfaces are estimated as less than or equal to 0.3% within a five year warranty period, the painting work will be accepted; otherwise, the contractor must conduct repair work before terminating warranty contracts. However, it is extremely difficult, if not impossible, for the naked eye to determine if the rust percentage is above or below 0.3%. Under the conventional visual inspection method, even two experienced paint inspectors may come up with different defect percentages and rate the condition differently. Thus, efficient digital image recognition methods need to be developed to complement existing inspection methods, which can provide an effective and convincing means to assess the condition of steel bridge coating.

Previously developed image recognition methods for painting rust defect assessment can be summarized as two: the NFRA (Neuro-Fuzzy Recognition Approach) method and the SKMA (Simplified K-Means Algorithm) method. The NFRA method uses artificial intelligence techniques to separate rust pixels from background pixels. The SKMA method segments object pixels and background pixels in a digitized image using a statistical method, so-called the K-means algorithm. Even if both methods pass through different processing procedures, one common logic is that they first convert original color images to grayscale images and further process the grayscale images.

This paper discusses the limitations of previously developed image processing methods for painting rust defect evaluations under several image acquisition conditions. These conditions are often encountered when acquiring digitized images and include non-uniform illuminations, low-contrast digital images, and noises on coating surfaces. Also, this paper presents a novel image processing method by utilizing digital color image processing.

## 5.2.2 Previous Image Processing Methods

### 5.2.2.1 NFRA Method

The NFRA method integrates the artificial neural networks and the fuzzy adjustment system to resolve the recognition problems arising from non-uniformly illuminated images (1). After acquiring a digital image and converting it to grayscale, the NFRA segments the grayscale image into three areas according to the illumination values of the pixels in that image. Illumination values are expressed as a number between 0 and 1. The darkest pixel becomes 0 and the brightest becomes 1. The average illumination values of three areas are computed and serve as the input

to pre-trained artificial neural networks (ANN). Once input values are provided to the artificial neural networks, three threshold values are generated for the three areas.

The fuzzy adjustment system is utilized to adjust the gray level values of the image pixels along the boundaries according to fuzzy if-then rules. Finally, image thresholding is performed to produce a binary image containing only the object and the background pixels. Each area is thresholded according to its corresponding threshold value computed from a previous stage. Pixels with gray level values smaller than the threshold values are considered as rust defects and pixel values higher than the threshold values are considered as the background. The rust percentage can be calculated by the ratio of black (defect) pixels to all pixels. If image pixels are expressed as  $F(i, j)$  and defect pixels are  $D(i, j)$ , then rust percentage (RP) becomes,

 Equation

$$RP(\%) = \frac{D(i, j)}{F(i, j)} * 100, \text{ for all } i, j \quad (1)$$

#### 5.2.2.2 SKMA Method

The SKMA method segments a grayscale image into two groups or clusters in a statistical method using so-called K-means algorithm (2). The K-means algorithm self-organizes data to create predetermined clusters or classes. In the case of bridge coating surface assessment, two classes are required: defective areas and non-defective areas. Clustering requires iterative processes to effectively separate rust pixels from background pixels. First, the gray levels of the first two pixels in an image are assigned to be the centers of two clusters. The K-means algorithm then assigns each of the remaining pixels to one of the two clusters based on the Euclidean distances from each point to the cluster centers. Then, the sample vectors in each cluster are averaged to produce new cluster centers. Next, each of the sample vectors is reassigned to the class to which the new representative center is closest. The iterative process is continued until the sum of the squared distances from all points in a cluster domain to the cluster center is minimized (4).

Light intensity values or the gray level values of an image are distributed on a 0 to 255 scale. Rust defects usually feature darker values than background areas, which makes grayscale distributions bimodal. A threshold value is selected between two modes, rust and background, so that processing errors can be minimized.

Light intensity values or the gray level values of an image are distributed on a 0 to 255 scale.

Once the process terminates, the SKMA method generates a thresholded binary image which yields the processed results. From the binary image, rust percentages can be calculated by computing the defect pixels out of all pixels in the image.

### 5.2.3 Limitations for Bridge Coating Evaluations

#### 5.2.3.1 Issues on Image Acquisition Conditions

Although a few rust defect assessment methods were developed in the past few years to evaluate bridge painting surfaces more objectively, they still have limitations when processing digitized images taken under several environmental conditions, which include: non-uniform illuminations, low-contrast digital images, and noises on painting surfaces. These situations are often experienced during bridge painting inspection or image acquisition and dealing with them is not an easy task when developing computerized programs. The following three examples show coating images related to these situations and the processed results by NFRA and SKMA methods.

Although a few rust defect assessment methods were developed in the past few years to evaluate bridge painting surfaces more objectively, they still have limitations when processing digitized images.

Figure 5-14 illustrates non-uniform illumination conditions, which may happen due to the fact that pavement, surrounding trees, and passing vehicles reflect sunlight irregularly. Figure 5-14(a) is an original color rust defect image acquired under non-uniform illumination conditions. Several spots of rust defects are located in the lower left corner. If the reason is unclear as to the non-uniform illumination of the image, it may be better to observe Figure 5-14(b) which is a grayscale image of the color image. It is noticeable that light intensities on the right side are darker than those on the left side of the image.

This image was processed using two image processing methods: NFRA and SKMA methods. Figure 5-14(c) shows the processed results by the NFRA method and Figure 5-14(d) is the processed results by the SKMA method. As indicated from Figures 5-14(c) and 5-14(d), both methods failed to produce reliable results compared to the original color image.

Figure 5-14:  
Non-uniform Illumination ((a)  
Original coating image, (b)  
Grayscale image, (c) Processed  
image by NFRA method, and  
(d) Processed image by SKMA  
method)

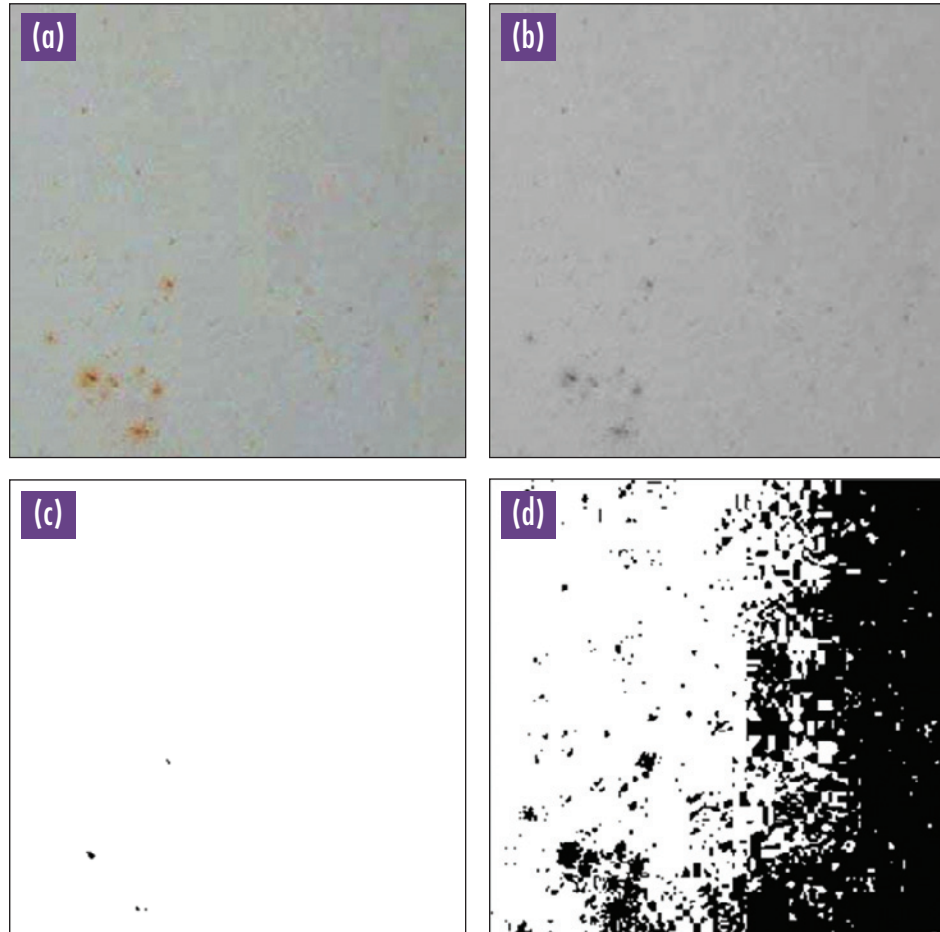

Figure 5-15 is an example of low-contrast rust images where rust pixels are not very distinct against the background. Figures 5-15(c) and 5-15(d) show the processed results by the NFRA method and the SKMA method, respectively. The processed image by the SKMA method recognized the rust areas too intensely and the processed image by the NFRA method recognized almost nothing. This example implies that dealing with low-contrast images is not a simple matter. Chen and Chang (1) also indicated that the contrast between rust defects and a background significantly affects the accuracy of the processed results and sharp contrast normally generates better recognition results.



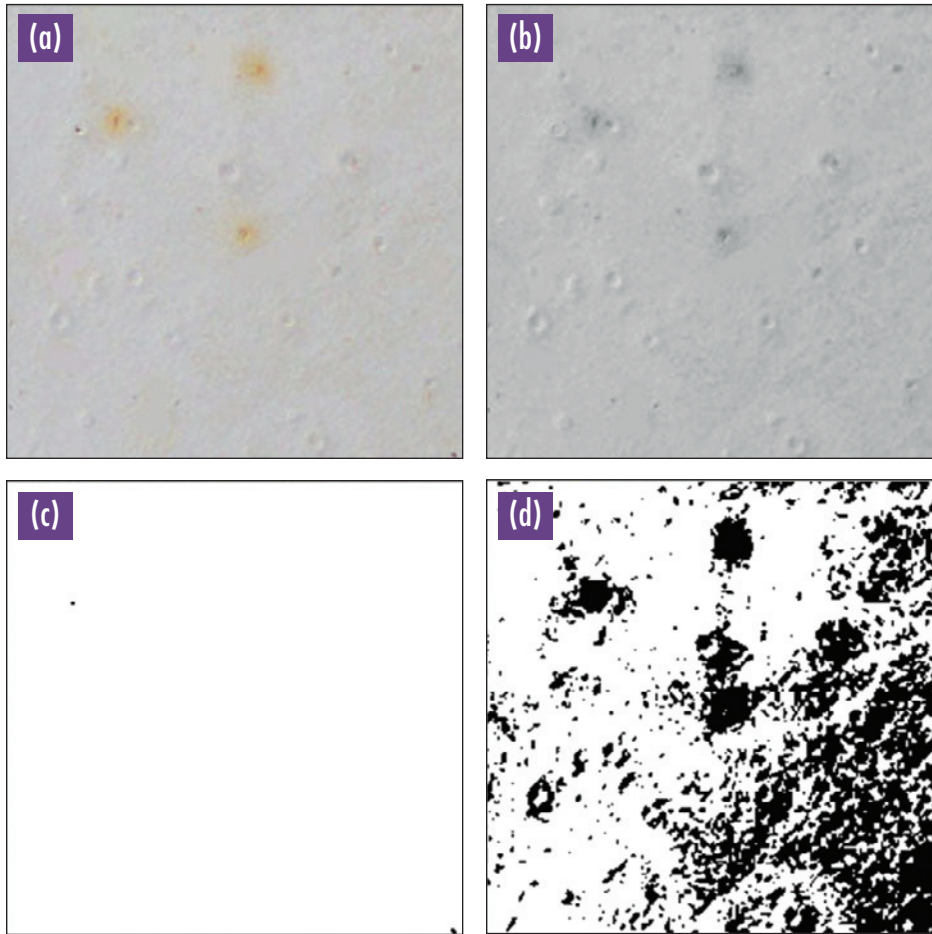
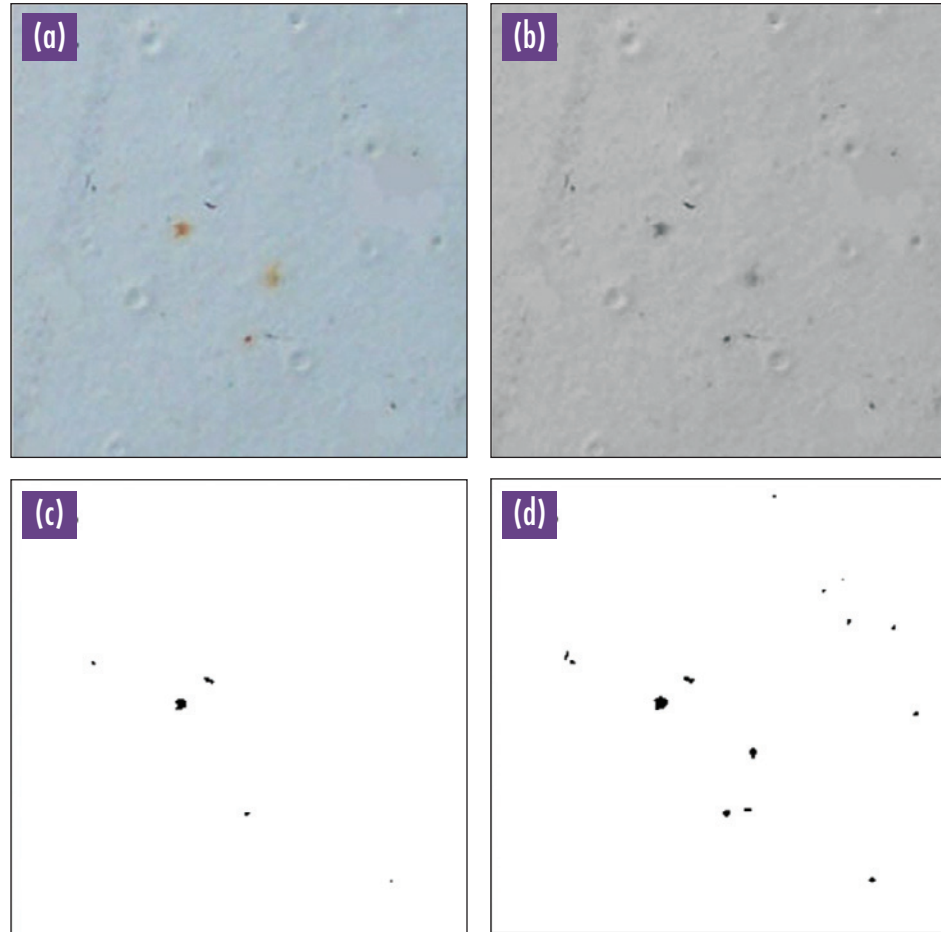

Figure 5-15:  
Low-contrast Images ((a)  
Original coating image, (b)  
Grayscale image, (c) Processed  
image by NFRA method, and  
(d) Processed image by SKMA  
method)

Figure 5-16 shows an example of noises on painting surfaces. Steel bridge painting surfaces are often stained with foreign materials such as accumulated dirt or the remains of small worms. Thus, developing computer programs being able to differentiate the noises from a background is an important issue. Figure 5-16(a) is a coating image containing noises on the surfaces where noises can be easily observed from the color image. Figures 5-16(c) and 5-16(d) shows the processed results by both methods. Both methods recognized rust defects and noises on the surfaces at the same time with a similar pattern, but the degree of recognition areas is somewhat different. The SKMA method recognized more noises than the NFRA method.

Figure 5-16:  
Noises on Painting Surfaces  
(a) Original coating image, (b)  
Grayscale image; (c) Processed  
image by NFRA method, and  
(d) Processed image by SKMA  
method)



### 5.2.3.2 Lessons and Motivations

Previous image processing examples demonstrated that the NFRA and the SKMA methods failed to generate reliable results under specific environmental conditions. Even if the NFRA and the SKMA programs pass through different processing procedures, one common thing is that they first convert original color images to grayscale images and further process the grayscale ones. Unsatisfactory processed results may be related to grayscale image processing. Grayscale images do not contain any information on color and express light intensities on a 0 to 255 scale.

Such grayscale images contain inherent limitations to separate rust defects on steel bridge surfaces under the problematic environmental conditions. For example, in the case of noises on painting surfaces, once original color images are converted to grayscale images, light intensities of rust defects become similar with those of noises. These light intensities then are mixed together, which makes the developed image processing methods more difficult to separate them efficiently. Likewise, under the non-uniform illuminations, after original color images are transformed

into grayscale images, rust defects and low-illuminated areas do not make a big difference in terms of light intensities, while rust defects are visibly distinct in the color images. These facts hindered the NFRA and the SKMA methods from differentiating rust defects reliably.

These findings formulated research motivations on the application of digital color image processing for more advanced rust defect assessment methods. Rust defects can be easily identified when looking at color images rather than grayscale images. Viewing and identifying color are originally a natural and powerful human sense. As humans perceive color, they can drive a car, distinguish similar objects by color, and enjoy four seasons. Returning to a steel bridge coating inspection, a bridge coating inspector can recognize the existence of rust defects by color as the defects on steel surfaces often appear reddish or brownish, which characteristically are distinctive against the paint background.

## 5.2.4 Architecture of Novel System Development

The novel system development procedures can be classified into three major stages; 1) Color space selection, 2) Further model development, and 3) Model testing and results. The following sections present the details of each stage.

### 5.2.4.1 Color Space Selection

A color can be represented as tuples of numbers in a mathematical model, called a color space. Choosing the appropriate color space is critical and must be completed before a rust defect assessment method can be developed. The color space was selected through the following three steps: i) to select the digital color spaces to be investigated, ii) to identify the distribution patterns of rust defects on the scatter plots, and iii) to determine the most optimal color space.



A color can be represented as tuples of numbers in a mathematical model, called a color space. Choosing the appropriate color space is critical and must be completed before a rust defect assessment method can be developed.

#### 5.2.4.1.1 Investigated Color Spaces

Extensive literature review indicated that a number of color spaces have been developed according to their own needs and application areas (5, 6, 7, 8, & 9). Considering large number of color spaces, they are categorized into several domains under which one or two representative color spaces were selected for further investigation. In this research, digital color spaces were categorized into five domains according to their development purposes or application areas: fundamental color space, human visual system-based color spaces, opponent-colors spaces, application-oriented color spaces, and uniform color spaces.



The fundamental color space is a basic color space, the RGB color space, in which red, green, and blue colors consist of primary colors and other colors are produced by adding or subtracting primary colors.

The fundamental color space is a basic color space, the RGB color space, in which red, green, and blue colors consist of primary colors and other colors are produced by adding or subtracting primary colors. It is called a generic color space and most other color spaces are derivatives of the space. The human visual system-based color spaces are the ones to specify colors in a way that is compatible with human terms, such as hue and saturation. The opponent-colors spaces are the ones to be based on the opponent-colors theory which proposed the existence of achromatic and chromatic channels in

the human visual system. The application-oriented color spaces are the ones which are applied for or closely associated with image-producing devices, such as color televisions and computer monitors. As image-related devices are widely used in our daily life, a number of color spaces are developed for efficient image processing, transmission, and storage. Finally, the uniform color spaces are the ones developed and standardized by the Commission Internationale de l'Eclairage (International Commission on Illumination, called CIE).

Based on the five domains, six commonly used digital color spaces were chosen and listed in Table 5-6 to find an appropriate color space to separate rust defects from steel bridge coating images. One color space was selected from each domain, while two color spaces were chosen from the application-oriented color space domain since more color spaces have been developed application-oriented. The two spaces have different purposes, one for color television transmission and the other for digital photography. The six chosen color spaces for the comparison are *RGB color space*, *HSV color space*, *Ohta color space*, *YIQ color space*, *YCC color space*, and *CIE L\*a\*b\** color space. Meaning and the usage of each color space cannot be explained in this space due to page limits and are described in Lee (3).

Table 5-6: Selected Color Spaces

Domain	Color Space
Fundamental	<i>RGB</i>
Human visual system	<i>HSV</i>
Opponent-colors space	<i>Ohta</i>
Application oriented color space	<i>YIQ</i>
	<i>YCC</i>
Uniform color space	<i>CIE L*a*b*</i>

#### 5.2.4.1.2 Distribution Patterns of Rust Defects

Numerous color spaces were selected in the previous step. In this step, their suitability for discriminating rust defects from a digital image was investigated. The investigation was performed to identify the relationship between rust defects and a whole digital image. The evaluation procedures consist of four steps. First, a digital bridge coating image is prepared. Second, the rust defect areas of the coating image are cropped from the digital image. Then, a whole bridge painting image and the cropped defect images are transformed into scatter plots simultaneously. The plots are presented in two dimensions since such representation provides clear visual information to identify the relationship between different classes. For instance, to examine the *RGB color space*, three kinds of distributions are necessary, i.e. red/green, red/blue, and green/blue. Finally, the distribution patterns on the scatter plots have to be investigated. The locations and distribution patterns of rust defects and coating images can be identified through the transformation from the image domain to the scatter plot domain. The plot shape and pattern between two areas, defective and non-defective areas, are an important factor in classifying two areas. Each image is transformed into six color spaces, i.e. *RGB color space*, *HSV color space*, *Ohta color space*, *YIQ color space*, *YCC color space*, and *CIE L\*a\*b\** color space.

For this experiment, a data set of 30 bridge coating images was prepared to test various images. The bridge coating images were acquired from the north side of Interstate Highway 65 in Indiana and visited bridges were coated with blue paint, one of the most commonly used painting colors.

#### 5.2.4.1.2 Optimal Color Space

The separability between two classes was investigated through the scatter plots of digital images to determine an optimal color space. The optimal color space was determined through the visual representation of the scatter plots because the plots clearly displayed the relationship between rust defects and image background. The thorough examination of scatter plots using the testing image set demonstrated that the *Cb/Cr* color space, two C components of the *YCC color space*, contains salient features for discriminating rust defects from a digital image. The color space was created by the Eastman Kodak Company for enabling the consistent representation of digital color images from other media (10). Figure 5-17 shows a sample digital image with rust defects and a typical scatter plot distribution on the *Cb/Cr* color space, where small red circles indicate rust defect areas.

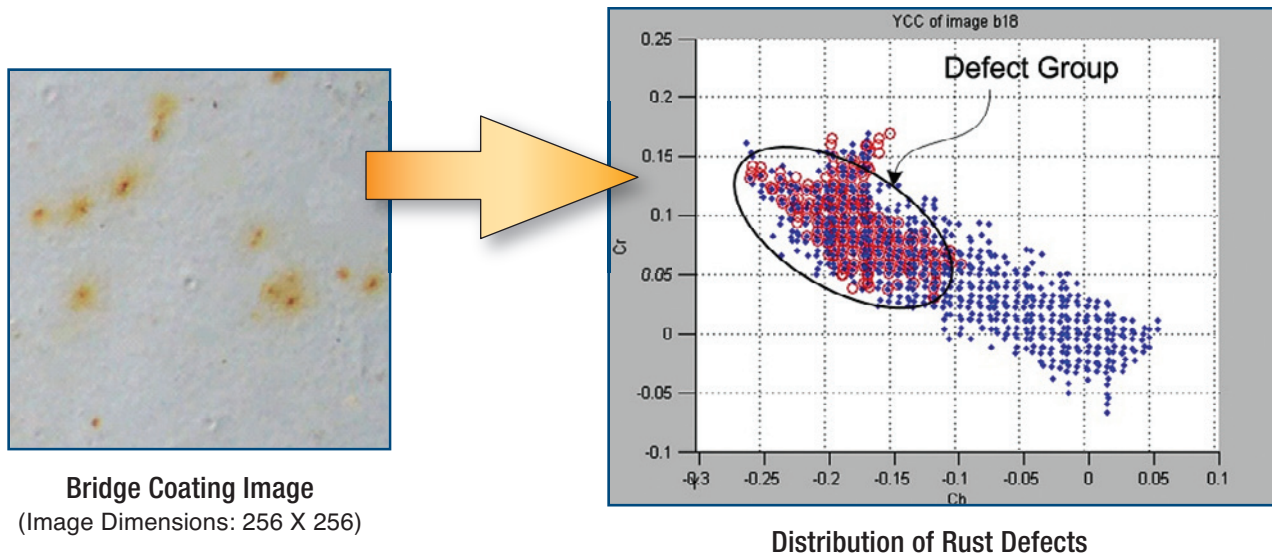

Figure 5-17: Scatter Plot Image Representation

The experimental results showed that the  $Cb/Cr$  color space provides several features to better separate defects from non-defects against other color spaces. First, the scatter plots feature a long linear shape for all the tested images. Second, defective areas are strongly clustered on the linear shape where defective areas are located on the upper-left side and non-defective areas are placed on the lower-right side. Such a characteristic can obviously provide a significant advantage for the recognition of rust defects. This fact can be explained by the calculations of two chrominance components,  $Cb$  and  $Cr$ . The transformation formula from the  $RGB$  color space for the  $Cb$  component is defined by  $(-0.299R - 0.587G + 0.886B)$ . And, the transformation formula for the  $Cr$  component is determined by  $(0.701R - 0.587G - 0.114B)$  (10). Those two equations indicate that the  $Cb$  component expresses only a bluish color as positive and the  $Cr$  component indicates that only a reddish color is positive. In the coating rust defect images, rust defects have a reddish appearance and a background has a bluish appearance. These facts facilitate the  $Cb/Cr$  color space to separate a whole coating image into two regions: defects and non-defects. Third, the distribution patterns of scatter plots in the color space are pretty consistent for all the tested images meaning that the color space can be applicable to the diagnosis of the degree of rust defects.

Based on the experimental results of the representation of digital coating images, the  $Cb/Cr$  color space was determined as an optimal color space for the accurate assessment of rust defects. This optimal color space needs to be further developed to effectively extract rust defects in a digitized coating image.

### 5.2.4.2 Further Model Development

Steel bridge coating images are first prepared for further processing. The images acquired using a digital camera can be simply transferred to a personal computer. These color images are stored in the format of the *RGB color space*. In other words, each image pixel can be expressed as the combination of three colors, red, green, and blue. For example, a pixel of  $x_{11}$  has the RGB vector of  $[0.95, 0.24, 0.65]^T$ , where  $T$  is a vector transposition. Then, each coating image is converted to an optimal color space identified in the previous stage. As aforementioned, the coating images in the space have notable features for separating rust defects from other areas such as the shape of the distributions and strong clustering of the defects. For example, the pixel of  $x_{11}$  can be transformed into  $x'_{11}$  as follows by using the transformation matrix of  $M$ .

$$x'_{11} = \begin{bmatrix} C_{b11} \\ C_{r11} \end{bmatrix} = \mathbf{M} \begin{bmatrix} R_{11} \\ G_{11} \\ B_{11} \end{bmatrix} = \begin{bmatrix} -0.299 & -0.587 & 0.886 \\ 0.701 & -0.587 & -0.114 \end{bmatrix} \begin{bmatrix} 0.95 \\ 0.24 \\ 0.65 \end{bmatrix} = \begin{bmatrix} 0.15 \\ 0.45 \end{bmatrix}$$

*Equation*

Once coating images are converted to a new space by the  $M$ , defective areas and non-defective areas tend to formulate separable clusters in the linear distributions. Defective areas are placed on the upper-left side and non-defective areas are located on the lower-right side while they form a long linear shape. To effectively separate defective areas, a new coordinate system can be created on the distribution of defective and non-defective regions. Figure 5-18 shows a conceptual diagram where defective and non-defective areas are located on the  $X1/X2$  coordinate system. If the original coordinate system can be shifted to create a new coordinate system ( $X1'$  and  $X2'$ ), then two areas can be easily set apart by putting a threshold value between two regions.

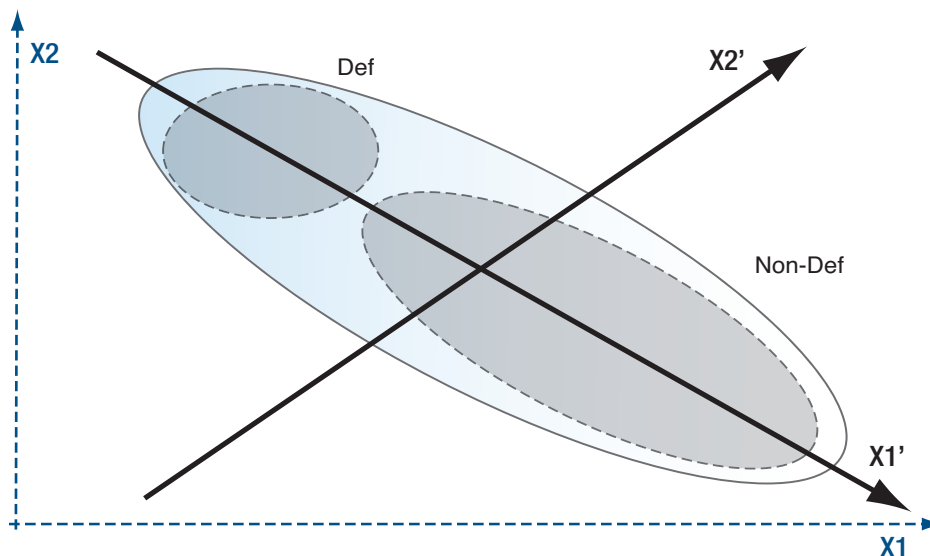

Figure 5-18:  
Adjustment of Coordinate  
System

The transformation can be made by applying a *Hotelling Transform* and its theoretical background is as follows (8).

#### 5.2.4.2.1 Hotelling Transform

Suppose that  $\mathbf{x}$ , an  $n$ -dimensional population vector, can be expressed as:

$$\sqrt{f} \text{ Equation } \quad \mathbf{x} = \begin{bmatrix} X_1 \\ X_2 \\ \vdots \\ X_n \end{bmatrix} \quad (2)$$

The mean vector of  $L$  vector samples from the population vector is defined as:

$$\sqrt{f} \text{ Equation } \quad \mathbf{m}_x = E\{\mathbf{x}\} = \frac{1}{L} \sum_{k=1}^L \mathbf{x}_k \quad (3)$$

Also, the covariance matrix is defined as:

$$\sqrt{f} \text{ Equation } \quad \mathbf{C}_x = E\{(\mathbf{x} - \mathbf{m}_x)(\mathbf{x} - \mathbf{m}_x)^T\} = \frac{1}{L-1} \sum_{k=1}^L \mathbf{x}_k \mathbf{x}_k^T - \mathbf{m}_x \mathbf{m}_x^T \quad (4)$$

Where,  $T$  = vector transposition.

Since the vector of  $\mathbf{x}$  is  $n$  dimensional, the covariance matrix of  $\mathbf{C}_x$  has  $n \times n$  dimensions.

The elements on the main diagonal of the  $\mathbf{C}_x$ ,  $c_{ii}$ , are the variance of the variable  $x_i$ . The element of  $c_{ij}$  in the  $\mathbf{C}_x$  indicates the covariance between the variables,  $x_i$  and  $x_j$ . The covariance is zero if the variables of  $x_i$  and  $x_j$  are uncorrelated.

The  $\mathbf{x}$  vector can be linearly transformed into a new vector of  $\mathbf{y}$  using a transformation matrix of  $\mathbf{A}$ .

$$\sqrt{f} \text{ Equation } \quad \mathbf{y} = \mathbf{A}\mathbf{x} \quad (5)$$

Then, the mean vector of  $\mathbf{y}$  is

$$\sqrt{f} \text{ Equation } \quad \mathbf{m}_y = \mathbf{A}\mathbf{m}_x \quad (6)$$

To make  $\mathbf{m}_y$  yield zero, the Equation 5 can be adjusted as follows.

$$\sqrt{f} \text{ Equation } \quad \mathbf{y} = \mathbf{A}(\mathbf{x} - \mathbf{m}_x) \quad (7)$$



This equation is called the *Hottelling Transform*. The transformation matrix of  $\mathbf{A}$  can be obtained from the eigenvectors,  $e_i$ , and eigenvalues,  $\lambda_i$ , of the  $\mathbf{C}_x$  where  $i = 1, 2, \dots, n$ . The eigenvectors and corresponding eigenvalues of the  $\mathbf{C}_x$  are arranged in descending order so that  $\lambda_j \geq \lambda_{j+1}$  where  $j = 1, 2, \dots, n-1$ . Then, the eigenvectors corresponding to the largest eigenvalue become the first row of the matrix  $\mathbf{A}$ . The eigenvectors corresponding to the second largest eigenvalue form the second row. Finally, the last row consists of the eigenvectors corresponding to the smallest eigenvalue.

Then, the covariance matrix of  $\mathbf{y}$  can be obtained as follows.

$$\mathbf{C}_y = \mathbf{A}\mathbf{C}_x\mathbf{A}^T \quad (8)$$

Where,  $\mathbf{C}_y$  is a diagonal matrix whose elements along the main diagonal are the eigenvalues of  $\mathbf{C}_x$  as follows.

$$\mathbf{C}_y = \begin{bmatrix} \lambda_1 & 0 & \dots & 0 \\ 0 & \lambda_2 & 0 & \vdots \\ \vdots & 0 & \ddots & 0 \\ 0 & \dots & 0 & \lambda_n \end{bmatrix} \quad (9)$$

The off-diagonal elements of the covariance matrix become zero, which means the variables of the  $\mathbf{y}$  vector are uncorrelated. It should be noticed that the values of  $\lambda$  in the main diagonal came from the eigenvalues of  $\mathbf{C}_x$ . Thus, the eigenvalues of  $\mathbf{C}_x$  and  $\mathbf{C}_y$  are identical. This transformation generates a rotation effect by changing a coordinate system.

Figure 5-19 shows the transformation result from Figure 5-17 after applying *hottelling transform*.

 Equation

 Equation

Figure 5-19:  
Effect of Hotelling Transform

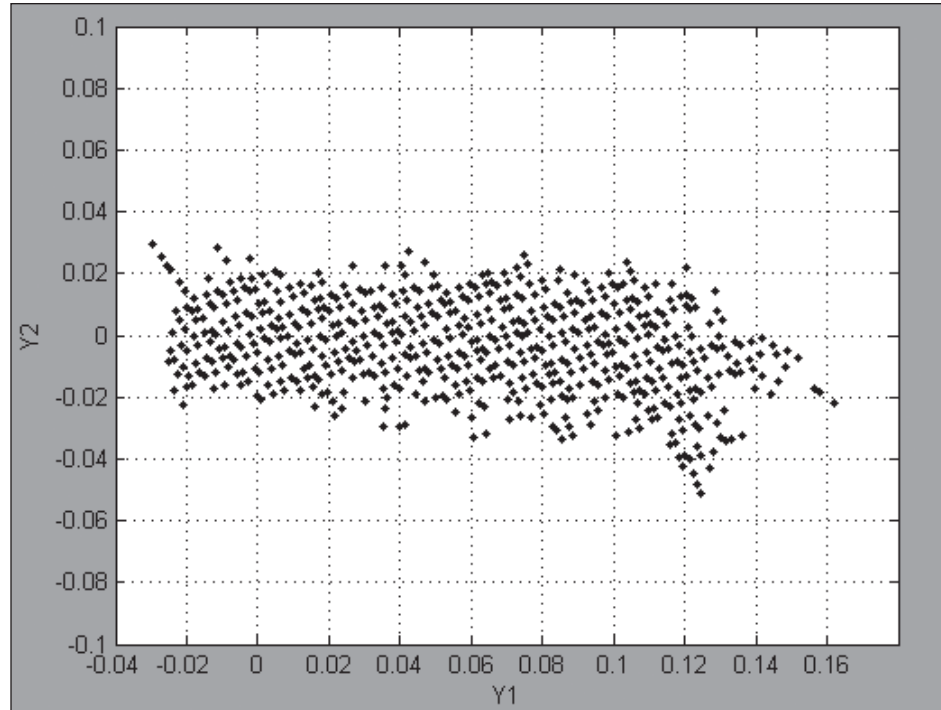

#### 5.2.4.2.2 Histogram Generation

Once all of the image pixels are aligned with a new coordinate system, they are projected onto a horizontal axis (Y1 axis in Figure 5-19) to create a frequency histogram. The histogram represents the distribution of the pixel values in a one-dimensional space where defective areas are grouped together on the right side and non-defective areas are placed on the left side.

After a histogram is generated, a threshold value is determined to classify defective areas and non-defective areas. According to the threshold value, each pixel of a given image has one of two values, 0 or 1, to build a binary image generation. If a threshold value is determined as  $\alpha$  to separate rust defects from a background on the histogram, pixel values more than the  $\alpha$  value become rust defects and the remaining pixels represent background areas.

#### 5.2.4.2.3 Image Reconstruction

Once a threshold value is determined, two values, 0 or 1, are given to each image pixel for a binary image generation. Pixels determined as rust defects have the value of 1 and pixels classified as a background have the value of 0. Then, the number of 1 becomes a black color and the number of 0 becomes white.

#### 5.2.4.2.4 Assessment of Defects

This step, a final step, is to evaluate the degree of defects in a percentage. Rust defect percentages can be calculated from the ratio of defective pixels to all pixels. Rust percentage or a degree of rust defects can be computed by the (Eq. 1).

#### 5.2.4.3 Model Testing and Results

A novel rust defect assessment method was proposed in the preceding sections. In this section, the effectiveness of the method needs to be discussed with experimental results in terms of rust recognition performances under various conditions. If a new method performs better than other methods, NFRA and SKMA, under different situations, it becomes pretty effective for bridge coating management.

Figure 5-20 shows the processed result under non-uniform illumination. It looks pretty obvious that a novel approach recognized rust defects reliably and can be compared with other results of the other methods as shown in Figure 5-14.

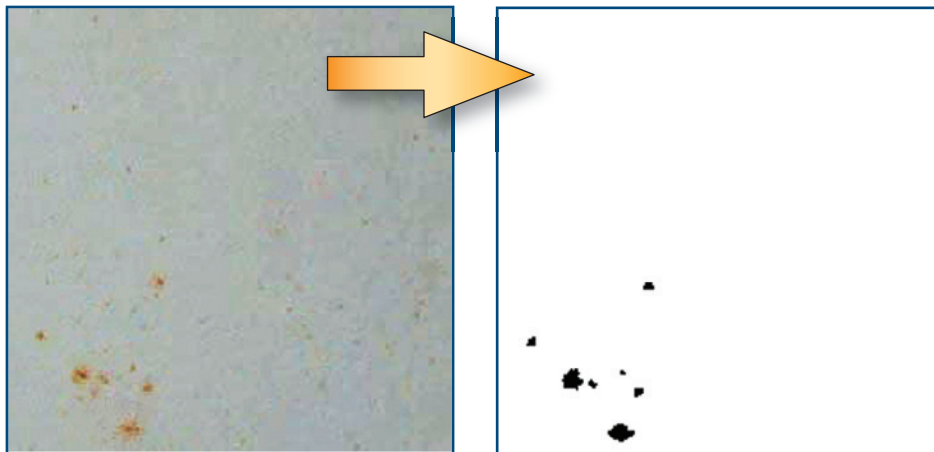

Figure 5-20:  
Processed Result under Non-  
uniform Illumination

Figure 5-21 shows the example of a low-contrast rust image and a processed result. Low-contrast images refer to the images where defect intensities visibly are not very distinct compared to background intensities. If the contrast is higher, rust defects will be recognized more clearly. The Figure 5-21 illustrates that a new method looks effective in processing digital images acquired under low –contrast conditions. The processed result is considerably different from the other two methods as shown in Figure 5-15.

Figure 5-21:  
Processed Result of Low-  
contrast Image



The last comparison condition is noises on the painting surfaces. Figure 5-22 shows the example of noises on the surfaces and a processed result. NFRA and SKMA methods recognized rust defects and noises on the surfaces at the same time while generating higher rust percentages than real (refer to Figure 5-16). However, a newly proposed method recognized only rust defects without being disturbed by noisy patterns and produced reliable processing results.

When choosing a threshold value, if a threshold value ( $\alpha$ ) is too high, say  $\alpha=0.1$ , processed defect areas become too small. If the value is too low, too large defect areas will be recognized from a given digitized image. As rust defect areas were segmented reliably around the threshold value of  $\alpha=0.06$  based on the examination of the data image set, the threshold value of 0.06 was applied for this performance evaluation.

Figure 5-22:  
Processed Result of Noises on  
the Surfaces

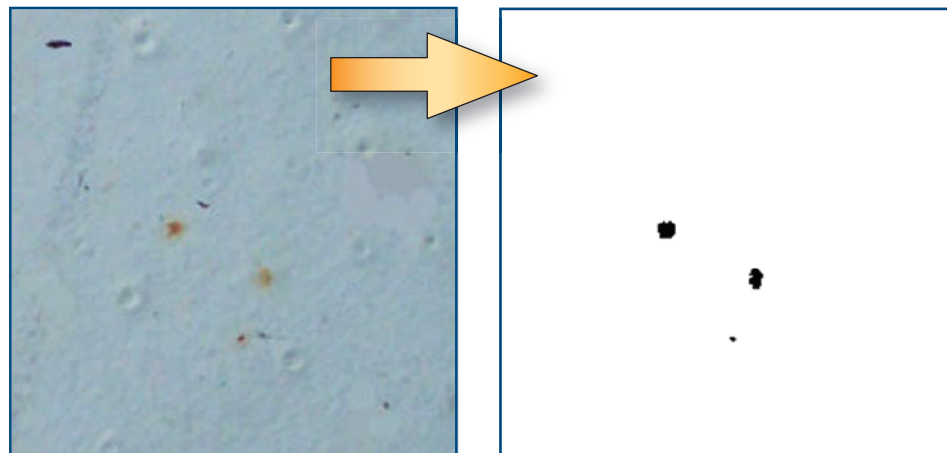

### 5.2.5 Conclusions

An accurate and objective rust defect assessment is required to maintain a good-quality steel bridge painting surfaces and make a decision whether a bridge shall completely or partially be repainted. For more objective rust defect recognition, digital image assessment methods have been developed for the past few years. Efficient image processing methods are also essential for the successful implementation of steel bridge coating warranty contracting where the owner, usually a state agency, and the contractor inspect steel bridge coating conditions regularly and decide whether additional maintenance actions are needed based on the processed data.



An accurate and objective rust defect assessment is required to maintain a good-quality steel bridge painting surfaces and make a decision whether a bridge shall completely or partially be repainted.

This paper introduced two rust defect assessment methods and described their theoretical backgrounds and limitations. The image recognition methods explained here are NFRA and SKMA methods. The developed rust defect assessment methods have some limitations when processing digitized images taken under specific image acquisition conditions. These conditions include: non-uniform illuminations, low-contrast digital images, and noises on painting surfaces. These situations are often experienced during bridge painting inspections and have to be taken care of to facilitate the automation of steel bridge coating inspection.

To deal with these environmental conditions effectively, a novel defect recognition method using digital color imaging system has been developed and introduced in this paper. Since color images basically provide more information than grayscale images, it was possible to develop more efficient defect recognition methods by investigating digital color information. The effectiveness of the novel approach was demonstrated by a number of bridge coating images and the experiment showed that the new approach produced improved recognition results under problematic environmental conditions.

### 5.2.6 References

Chen, P. H. and Chang, L. M., *Intelligent Steel Bridge Coating Assessment Using Neuro-Fuzzy Recognition Approach*, *Computer-Aided Civil and Infrastructure Engineering*, Vol. 17, No. 5, 2002, pp. 307-319.

Chang, L. M., Chen, P. H., and Lee, S., *Implementation of Steel Bridge Protection Policy*, FHWA/IN/JTRP-2001/29, Joint Transportation Research Program, Purdue University, West Lafayette, Indiana, Final report, October 2003.

Lee, S., *Digital color image processing system for civil infrastructure health assessment and monitoring – steel bridge coating case*, Ph.D. Thesis, Department of Civil Engineering, Purdue University, 2005.

Looney, C. G., *Pattern Recognition Using Neural Networks*. Oxford University Press, Inc., New York, New York, 1997.

Plataniotis, K. N. and Venetsanopoulos, A. N., *Color image processing and applications*, Springer-Verlag Berlin Heidelberg, Germany, 2000.

Fairchild, M. D., *Color appearance models*, Addison Wesley Longman, Inc., Reading, MA, 1998.

Sangwine, S. J. and Horne, R. E. N. (edited). *The colour image processing handbook*, Chapman & Hall, Great Britain, 1998.

Gonzalez, R. C. and Woods, R. E., *Digital image processing*, Addison-Wesley Publishing Company, Inc., 1992.

Sharma, G. (edited), *Digital color imaging handbook*, CRC Press, 2003.

Eastman Kodak Company. *Fully utilizing photo CD images*, <http://www.kodak.com/global/en/professional/products/storage/pcd/techInfo/pcd-045.jhtml#YCC>. Accessed April 20, 2003.

## 5.3 The Electrochemical Fatigue Sensor (EFS)

*Monty A. Moshier, Ph.D.<sup>3</sup> and Marybeth Miceli<sup>4</sup>*

### 5.3.1 Introduction

The Electrochemical Fatigue Sensor (EFS) system is an innovative, nondestructive testing method for detecting growing cracks in metal components. Fatigue is one of the primary degradation mechanisms that limit the life of structures constructed using metal components. Furthermore, cracks in metal components that result from fatigue may eventually grow to some critical length causing failure of the structure. When fatigue cracks grow to critical lengths in steel bridges the bridge either fails, is closed, or requires significant repairs to return it to normal service. The county's aging bridges are littered with fatigue cracks.

Currently, classifying fatigue cracks and prioritizing their repair is primarily completed with information gathered visually. According to a study commissioned by the Federal Highway Administration, over 90% of these potentially dangerous cracks are missed through visual inspection (1). MATECH Corp. (MATECH) in conjunction with the U.S. Air Force and the University of Pennsylvania researched and developed the EFS technology in the early 1990's to detect growing fatigue cracks in metals. The original research was aimed at developing a technology for detecting problem cracks in airframes and engines. Since that time, additional research and development has resulted in the adaptation of the EFS system for steel bridge inspection. Over the last three years EFS has been successfully used to inspect bridges in the United States and Australia.



The Electrochemical Fatigue Sensor (EFS) system detects and monitors fatigue crack growth in metal structures. The EFS system determines the microplasticity crack growth or the potential of future crack initiation in the inspection area by monitoring changes in the passive oxide layer imposed by the EFS system. The EFS system has been used on highway and railroad bridges in two countries. This paper introduces the EFS system and its uses, as well as discusses three bridge inspections that were completed using the EFS system. EFS results are categorized as "actively growing," "exhibiting microplasticity" (indicating likely future crack initiation and propagation), and "no activity." Results have given bridge owners more information, allowing for better bridge management decisions regarding repair, maintenance, and retrofits. Crack locations, EFS inspection results, and subsequent management decisions are discussed.

**INFRASTRUCTURE TYPE:** Metal components

<sup>3</sup> 1SUEE, 316 South 400 East, Suite D4, St. George, UT 84790, T: 435-215-4183, moshier@suengineers.com

<sup>4</sup> MATECH Corp., 11661 San Vicente, Blvd., Suite 707, Los Angeles, CA 90049, T: 310-208-5589, F: 310-473-3177, marybeth@matechcorp.com



The EFS system's ability to detect growing cracks provides an immediate benefit to bridge safety and maintenance. The EFS system provides immediate retrofit verification and the immediate diagnosis of fatigue cracks in steel bridges.

The EFS system's ability to detect growing cracks provides an immediate benefit to bridge safety and maintenance. The EFS system provides immediate retrofit verification and the immediate diagnosis of fatigue cracks in steel bridges. The EFS system provides previously unavailable information that can be used to prioritize maintenance repairs, discover problem failure areas, and verify retrofit designs; collectively this provides information that can be used to save money and lives by helping to extend bridge life and eliminate bridge failures.

### 5.3.1.1 The EFS System

#### ■ Technical Background on the EFS System

The EFS system is a nondestructive testing method that detects active crack growth, either of known cracks or in areas that are susceptible to fatigue cracking. During an EFS inspection, an EFS sensor array is temporarily installed each location of interest. The EFS inspection system consists of electrolyte filled sensors (used in pairs), a potentiostat that applies a precise constant polarizing voltage between the structure and the sensors, a ground, and data collection and analysis software.

The EFS system is a nondestructive testing method that detects active crack growth, either of known cracks or in areas that are susceptible to fatigue cracking.

During testing, the inspection areas encompassed by the sensors are anodically polarized to create a passive film on the areas of interest. This polarizing voltage produces a DC base current in the electro-

chemical cell. As the structure is exposed to cyclic stresses, the current flowing within the cell fluctuates in a complex relation to the variations in the mechanical stress. This results in an AC current superimposed on the base DC current.

During cyclic loading, the fatigue process causes micro-plasticity and strain localization on a very fine scale. The interaction of the cyclic slip and the passivating process (due to the applied polarizing voltage) causes temporary and repeated changes to the passive layers. These disruptions, including both dissolution and repassivating processes, give rise to transient currents. Dependent upon the material properties, the loading conditions, and the activity of the cracks under inspection, this transient current provides information on the status of fatigue damage at that location.



It is important to note that the transient currents generally possess the same frequency as that of the mechanical stress, but also have a complex phase relationship. In addition, the disruption of the passivation layer by the cyclic slip causes an additional component of the transient current which has double the frequency of the elastic current due to the disruptions occurring during both the tensile and compressive portions of the loading cycle.

It is important to note that the transient currents generally possess the same frequency as that of the mechanical stress, but also have a complex phase relationship.

As fatigue damage develops, the resulting cracks induce localized plasticity at different parts of the fatigue cycle from those in which the background micro-plasticity occurs and in locations where cracks have not yet formed inducing higher harmonic components into the transient EFS current. Analysis of each of these multiple current components indicates whether a crack is actively growing.

#### 5.3.1.1.1 The EFS Sensor

The basic EFS sensor, shown in Figure 5-23, consists of several integral parts. Each sensor has a peel back contact adhesive on one side for attachment to the structure. The open area in the middle of the sensor holds the subsequently described EFS electrolyte. The sensor is filled with the EFS electrolyte through the lower filler tube while air escapes through the upper bleeder tube. The EFS sensor electrode – a stainless steel mesh – is sandwiched between the upper and lower sensor sections. When the sensor is filled with electrolyte, the electrode is completely covered. Depending on the area to be tested, EFS sensors can be custom-made to fit any three-dimensional geometric requirements (including size, shape, orientation, etc.).

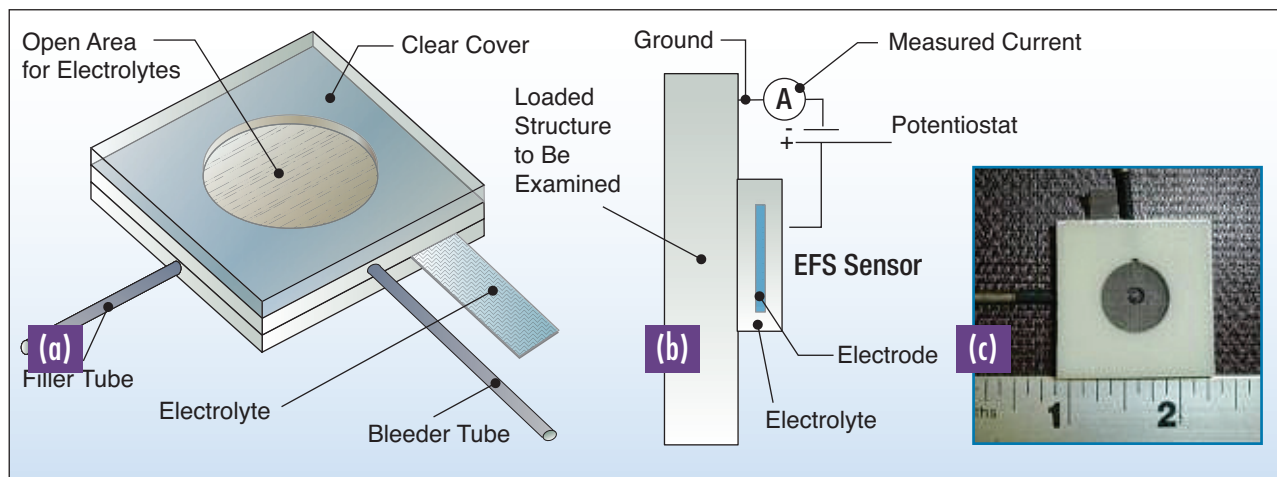

Figure 5-23: (a) Schematic of the EFS sensor (b) Schematic of EFS System in use (c) Photograph of EFS sensor

To enhance the sensitivity of the EFS system, a configuration known as differential EFS is employed. Differential EFS is a sensor array with one reference (R) and one crack measurement (CM) sensor. The CM sensor is located over the area of interest and the R sensor is located near the CM sensor but in a location where a crack is not probable. In this configuration both sensors experience the same elastic loading conditions. Using various proprietary signal and data processing techniques, the signals from the two sensors are compared to determine if a crack is present. In the presence of a growing crack, the CM measurement sensor outputs a greater absolute current magnitude than the R sensor data and contains the extra frequency content as alluded to earlier.

#### 5.3.1.1.2 The EFS Electrolyte

The chemical composition of the EFS electrolyte is proprietary.

The chemical composition of the EFS electrolyte is proprietary. It is a water-based solution that has been tested on multiple materials including aluminum, titanium, copper, and steel and has been found to be benign to metals in all studies. The electrolyte is inert and environmentally safe.

#### 5.3.1.1.3 The EFS Potentiostat Data Link

The EFS potentiostat data link (PDL) is an electronic device that has been custom designed not only to precisely control the voltage between the inspection material (the steel bridge member) and the sensor but to also measure and store the current data. The current data are then used to determine the crack growth activity of the inspection location.

The battery-powered, wireless PDLs and access points, shown near the bottom of Figure 5-24 (note: PDLs are numbered 60, 55, 62, etc.; access points are located directly behind the PDLs) provides all of the features necessary to collect data in the field. The potentiostat is compact, lightweight, and provides isolated channels for the R sensor and the CM sensor. The MATECH PDL features onboard A/D conversion, data collection to a removable MMC card, wireless data streaming, and an easy to use wireless setup for bias, gain, and sample rate. The access points are used to setup a temporary network on the bridge for wireless communication between PDLs and an interfacing control laptop.

#### 5.3.1.1.4 The EFS Software

An easy to use software package was developed specifically for the collection and analysis of EFS data. The software uses a proprietary algorithm, various filters and windowing to analyze the collected data. Specifically, a chirp Z-Transform, or CZT, is used to extract the relevant frequency data from the bridge loading frequency spectrum.

The software allows for a raw EFS current output in the time domain and an FFT of the time-based data, both of which are analyzed to determine the activity of a crack. Both output types are used throughout the following sections.

In general, crack growth is indicated when the ratio of the CM sensor output to the R sensor output in both the frequency and time domains is at least 2.0. This has been termed the *Energy Ratio*. That is, the CM current output (EFS signal) should be at least twice that of the sensor to indicate an active crack. Current output for the CM sensor in the range of 1.5 to 1.9 times that of the R indicate that microplasticity may be occurring at that location and that the area is at an elevated risk for future crack growth. Those areas should be kept under observations. Output below 1.5 generally indicates little to no crack growth is occurring. These are general and simplified guidelines for the purpose of quickly determining the crack activity.



Figure 5-24: The EFS wireless access point antenna (back) with the numbered PDLs and individual wireless antennae (front). Sensors and electrolyte shown in foreground.

### 5.3.2 The EFS System and Bridge Management

Traditional fatigue crack inspection tools give inspectors information about the condition of the inspected structure. That information, however, does not give information beyond a good – no good indicator. The fundamental operational characteristics of the EFS system mean that higher-order information is provided. The following section briefly describes the various ways that the EFS system can and is currently being utilized in bridge management approaches.



Traditional fatigue crack inspection tools give inspectors information about the condition of the inspected structure. That information, however, does not give information beyond a good – no good indicator.

#### 5.3.2.1 Traditional Inspection Tool

The first way that the EFS system can be utilized is as a simple replacement for other technologies. In this way, the EFS system is used in combination with engineering judgment and visual inspection techniques to inspect

fatigue sensitive areas. The information derived from such usage gives engineers information on which inspection locations are devoid of growing cracks and which locations have active cracks present. Further, for those locations with active cracks the owner is presented with a qualitative assessment of what the crack growth rate is.

### 5.3.2.1 A Tool for Prioritizing Repairs



When a number of locations are inspected on a single bridge or a group of bridges the results of an EFS inspection can be utilized to prioritize repairs and repair dollars.

When a number of locations are inspected on a single bridge or a group of bridges the results of an EFS inspection can be utilized to prioritize repairs and repair dollars. As touched on above the results of an inspection results in the assignment of one of three categories: (1) no growing crack, (2) strong potential for future crack growth, (3) growing crack. The prioritization then of where to repair first, where repairs can wait, and where repairs are not needed is straight forward.

### 5.3.2.3 A Tool for Verifying the Efficacy of Repairs

Fatigue crack repairs take a variety of forms depending on the structural geometry and loading conditions.

Fatigue crack repairs take a variety of forms depending on the structural geometry and loading conditions. As one example, stop-holes are frequently drilled at crack tips as a means of altering high-stress conditions. However, attempts to “capture” the crack tip are frequently unsuccessful as identifying the true crack tip is generally difficult to impossible. In this instance, an EFS inspection could be performed near the stop-hole to verify that the crack tip had been completely removed. In other cases, geometrical changes to a bridge are made to alter the load path causing high fatigue stresses. For example, out-of-plane fatigue cracks are frequently identified in the web-gap regions of steel girder bridges. As it is known that the out-of-plane stresses result from differential deflection of adjacent girders, one common repair is to loosen cross frame bracing connectors or to completely remove the bracing. This repair effectively changes the load paths causing the locally high stresses. In this instance, an EFS inspection could be performed near the known fatigue crack to verify that micro-plasticity near the crack tip has been eliminated. Regardless of the type of fatigue crack or the repair methodology employed, an EFS inspection provides immediate feedback on the effectiveness of the repair at removing the conditions causing critical stress levels. This approach (repair – inspect – mitigate), then, would represent an active approach to bridge management and repair.

### 5.3.3 Pennsylvania Inspections - Case Study

Twelve PennDOT structures have been inspected using the EFS system to determine crack growth activity and/or retrofit and repair efficacy. Shown in Figure 5-25 is a typical structure; a twin 23-span bridge system located near Harrisburg, PA.



Figure 5-25:  
Bridge located near  
Harrisburg; southbound span  
shown here.

These structures were built in 1972 with the first full year of traffic in 1976. In 1993, fatigue cracking was identified by a PENNDOT consultant during a biennial inspection. A number of locations exhibited cracking in a coped beam to girder connection. The identified cracking is a result of out-of-plane bending in the girders resulting from high live load stress ranges. A typical cracked coped beam to girder connection detail is shown in Figure 5-26.



Figure 5-26:  
Typical cracked coped detail at the floor beam to girder connection. Photo on the right shows the detail with the EFS installed.

Six locations of the subject bridge were evaluated using the EFS system. Table 5-7 summarizes the crack growth activity at each EFS system location.

**Table 5-7: Tabulated Results from the Six Inspected Locations**

Inspection Location ID	Crack Visually Detected?	Energy Ratio	Activity
1-52	Yes	16.0	Active Growth
2-53	Yes	11.0	Active Growth
3-54	Yes	5.0	Active Growth
4-63*	No	1.8	Microplasticity
5-57	Yes	8.4	Active Growth
6-62	Yes	5.6	Active Growth

\*NOT PREVIOUSLY DOCUMENTED IN INSPECTION REPORTS

Locations 1 through 3, 5, and 6 all exhibited very active crack growth under ambient traffic loads. Both the frequency and time domain data exhibited a large difference in magnitude and frequency content between the CM sensor and the R sensor. At some locations the Energy Ratio was as much as 16. It is important to note that location 4 had no visual detection of a crack previously reported. With an Energy Ratio of 1.8, microplasticity is occurring; therefore, crack initiation and propagation are likely and it would, therefore, be an area where further observation would be warranted.

Figure 5-26 shows a typical fatigue sensitive detail with the EFS sensors installed; the corresponding results from an active crack at that detail are shown in Figure 5-27. It should be noted that prior to EFS system testing this specific location was designated as not cracked. However the EFS inspection revealed an actively growing crack that had not been previously documented.

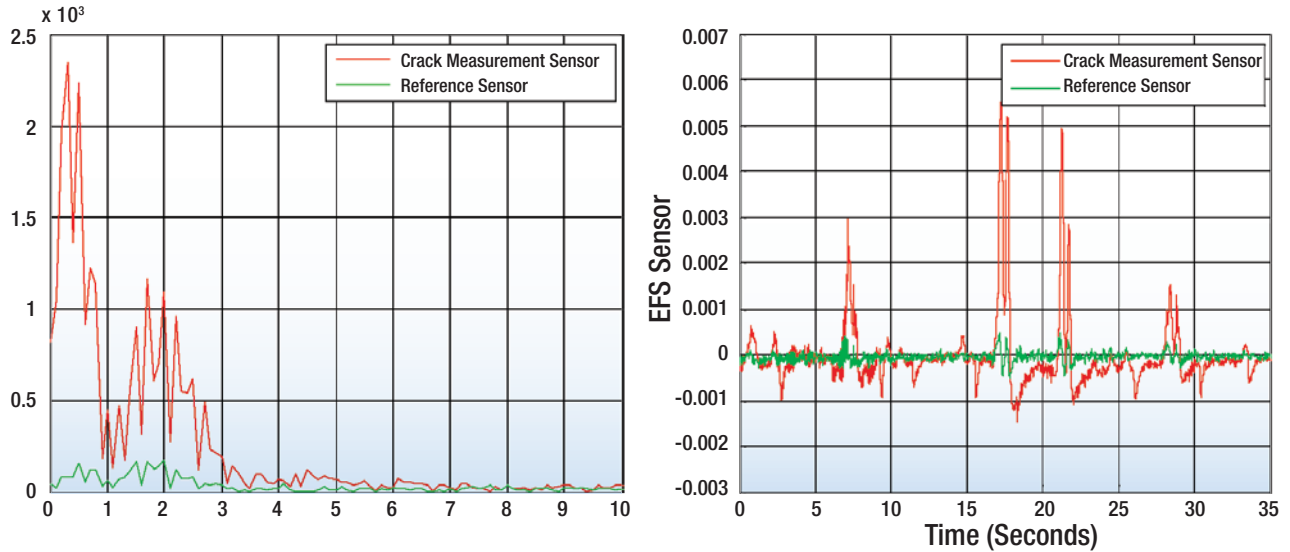

Figure 5-27: EFS response from an actively growing crack at the coped detail.

### 5.3.4 Inspections Performed In New York

Retrofits were designed and installed in four locations where cracking occurred in the floor beam webs, at the connection with the gusset plates. The designed retrofit required removal of a section of the floor beam web in the shape of a large teardrop (Figure 5-28). Two locations on each of the four retrofit locations were inspected with the EFS system to determine if active fatigue cracks were present and if the four retrofits had been successful in reducing the likelihood of future fatigue cracking. Custom sensors were designed specifically for this test to curve around the retrofit design. The sensors were installed around the large radius (location 1a figure 5-28) of the retrofit and in a location near the bolted connection (location 1b in figure 5-28) where NYSDOT had suspected higher strain values.

Based on the traffic at the time the data were collected (evening rush hour), the first inspection test results indicated that this retrofit area is not exhibiting plasticity or signs of active crack growth. This finding is evident in both the frequency and time domains, as shown in Figures 5-29, 30, 31 and 32. The energy ratio between the EFS CM sensor and the R sensor signal was 1.40 and  $<1.1$  for locations 1a and 1b, respectively. Energy ratios below 1.5 indicate that there is little to no plasticity occurring and thus no signs of crack growth or future initiation. A summary of results for location 1 is presented in Table 5-8. The locations were re-inspected 7 months later and similar data were collected. The energy ratio between the EFS CM sensor and the R sensor signal was 1.30 and 1.31 for locations 1a and 1b, respectively. Again, this represents little to no plasticity occurring and thus no signs of crack growth or future crack initiation. A summary of the re-inspection results is presented in Table 5-9.

**Figure 5-28:**  
EFS Sensors Installed Near  
Retrofit

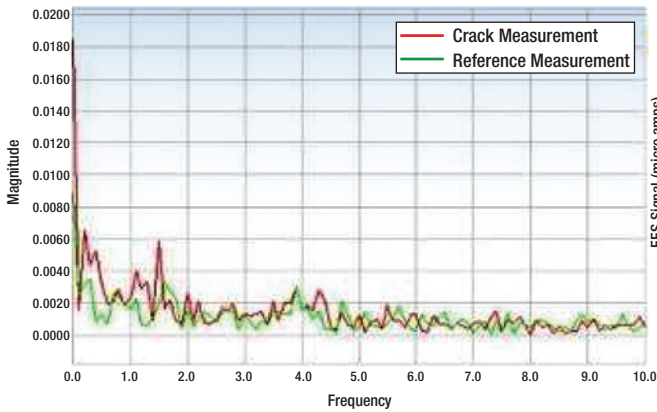
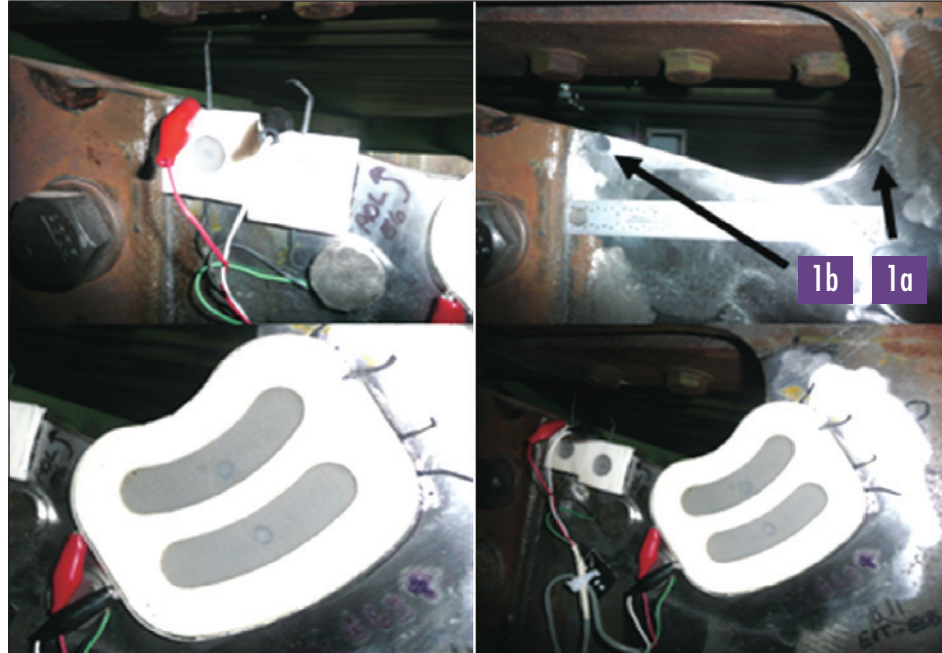

**Figure 5-29:** Output of Frequency Domain of Location 1a

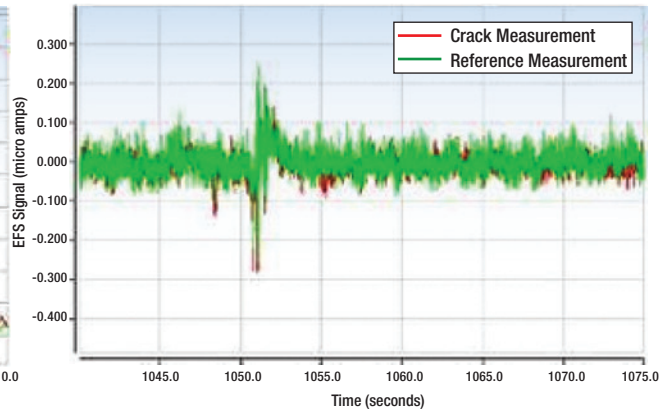

**Figure 5-30:** Output of Time Domain of Location 1a

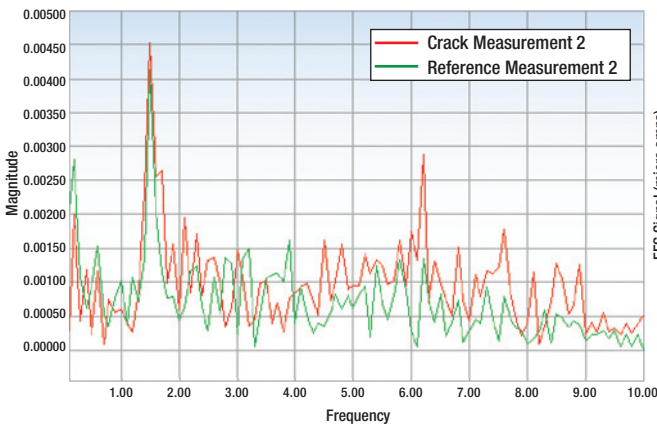

**Figure 5-31:** Output of Frequency Domain of Location 1b

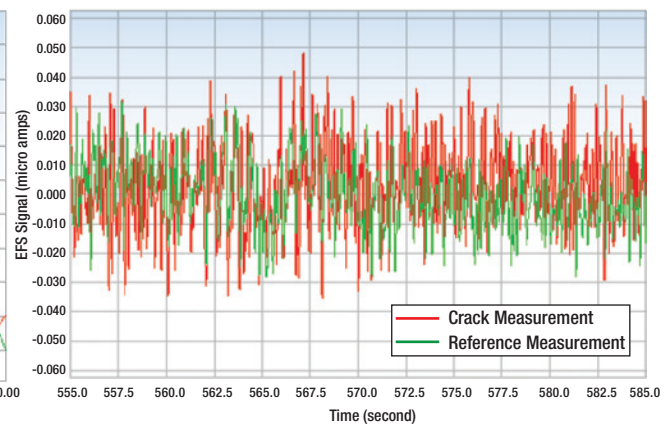

**Figure 5-32:** Output of Time Domain of Location 1b



Table 5-8: Summary of November Results

EFS Location Number	Crack Location				PDL	Energy Ratio	Visual Crack?	Activity
	Span	Truss	Floor Beam	Location				
1a	5	1	11	Exterior	63	1.40	No	No Activity
1b	5	1	11	Exterior	56	<1.1	No	No Activity

Table 5-9: Summary of June 2008 Results

EFS Location Number	Crack Location				PDL	2008 Energy Ratio	Visual Crack?	Activity
	Span	Truss	Floor Beam	Location				
1a	5	1	11	Exterior	60 Ch 1	1.30	Retrofit	No Activity
1b	5	1	11	Exterior	60 Ch 2	1.31	Retrofit	No Activity

### 5.3.5 Inspections Performed In Virginia

Two bridge inspections were performed for VDOT in 2008. The first highway bridge structure was inspected at three locations using the EFS system to determine the activity of cracks. Two details were inspected at a diaphragm connection location. The area inspected was a previously retrofitted crack area that had been stop drilled. Additionally, a newly retrofitted area that had also been stop drilled was also inspected. A sketch showing the installation locations is provided in Figure 5-33.

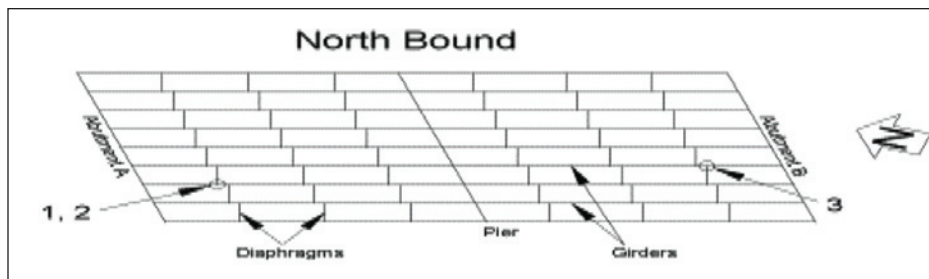

Figure 5-33:  
Inspection locations on VDOT  
Highway Bridge Structure

After data collection, the data were examined and analyzed using the custom EFS system software to determine crack growth activity. The software consists of frequency and time domain based algorithms used to analyze and report the data. Multiple data sets from each location were examined in order to ensure repeatability of results. A summary of the results is contained in Table 5-10.

Table 5-10: Summary of Results

Number	Crack Location			PDL	Crack Visually Detected?	Retrofitted	Energy Ratio	Activity
	Side	Beam	Diaphragm					
1	North	3	1	50 Ch 1	No	Yes	1.55	Potential Growth
2	North	3	1	50 Ch 2	No	Yes	1.65	Potential Growth
3	South	4	1	57	Yes	Yes	2.60	Actively Growing

Location 3 was inspected using PDL unit #57, as shown in Figure 5-34. A combination of a drill stop and bolted angle had been used to arrest the propagation of an existing crack. After removing the paint at the location, it was discovered that the drill stop had failed to capture the tip of the crack. One set of sensors was installed on the girder web, oriented vertically adjacent to the crack tip to determine if crack growth was still occurring.

Figure 5-34:  
Location 3 – 4th Beam, 1st  
Diaphragm

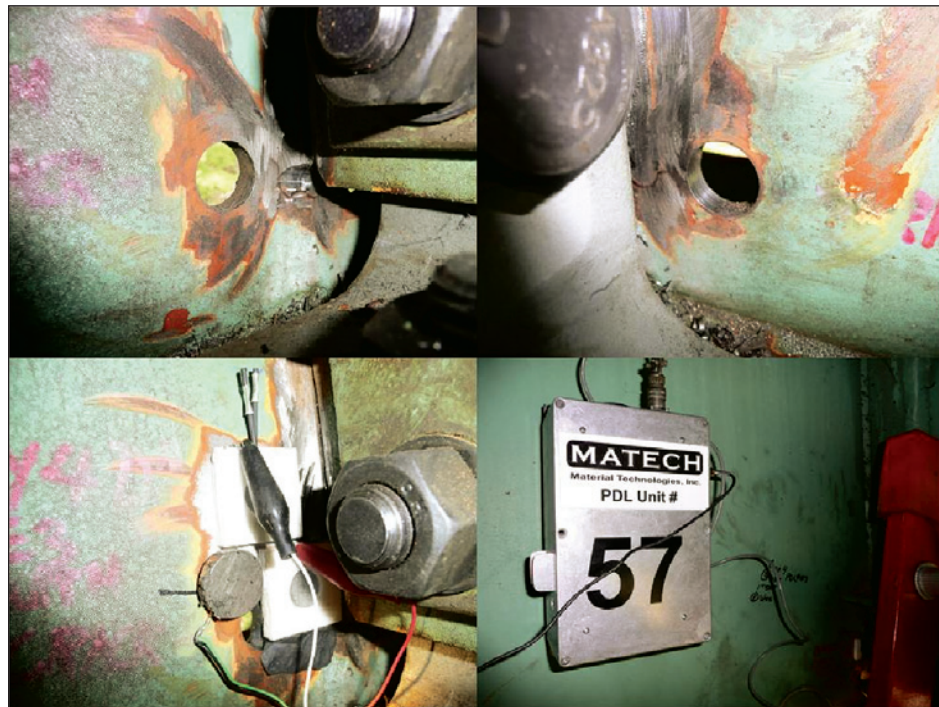

**NOTE:** The top left picture shows the drill stop and crack tip. The drill stop did not capture the tip of the crack. The top right picture shows the drill on the other side of the diaphragm. The bottom left picture shows the sensors installed at the location. The bottom right picture shows a far field view of the EFS installation.

Based on the traffic at the time the data were collected, the test results indicate that the crack is actively growing. This is evident in both the frequency domain and the time domain, as shown in Figures 5-35 and 5-36. The energy ratio is on the order of 2.60 at this location. Recall that energy ratios above 1.9 suggest that active crack growth is occurring.

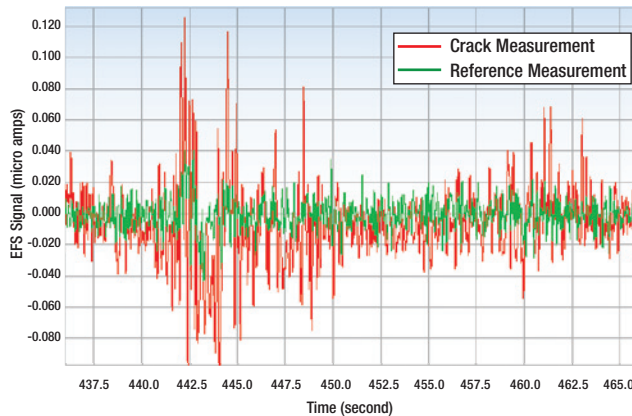

Figure 5-35:  
Output of Time Domain of Location 3

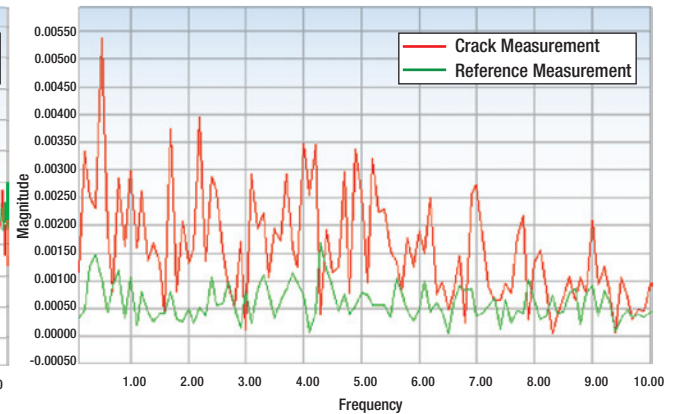

Figure 5-36:  
Output of Frequency Domain of Location 3, Energy Ratio = 2.60

It should be noted that the other two locations, where the crack arrest hole captured the crack tips, were still exhibiting higher energy ratios. These were in the range that indicates microplasticity is already occurring and future crack initiation and propagation is likely. Locations with energy ratios in this range should be further repaired or kept under observation.

### 5.3.6 Summary

The EFS system is currently being deployed in multiple states as an important bridge management decision tool. The system accurately monitors crack behavior at known sites as well as monitoring the likelihood of crack initiation and degree of crack propagation in fatigue prone locations that are undetectable by visual inspections. EFS investigation results aid in the prioritization of repairs and subsequent review dates based on the degree of severity the crack propagation behavior demonstrates. Prioritizing problem areas ensures public safety and is cost efficient. Problem areas can be detected and corrected earlier than cases using alternate technology. Repairs are then monitored and tested for efficacy using the EFS system to help DOT's attain the optimal quality they seek in repairs and retrofits.



The EFS system is currently being deployed in multiple states as an important bridge management decision tool.

### 5.3.7 References

Moore, M.E., B.M. Phares, B.A. Graybeal, D.D. Rolander, and G.A. Washer, “Reliability of Visual Inspection of Highway Bridges” Federal Highway Administration Report FHWA-RD-01-20, Washington, DC, 2001.

*National Bridge Inspection Standards*. Washington, DC: United States Department of Transportation, Federal Highway Administration; Government Printing Office (2002).

Ryan, T., R. Hartle, J. Mann and L. Danovich., *Bridge Inspector’s Reference Manual* [No. FHWA NHI 03-001]. Arlington, Virginia: Federal Highway Administration, National Highway Institute (2006).

Kirk, R. and W. Mallett. [RL34127] *CRS Report for Congress, Highway Bridges; Conditions and the Federal /State Role*. Washington, DC: Congressional Research Service: (2007): p CRS-14.

Miceli, M., S. Schwartz, B. Phares, M. Moshier. “Active Fatigue Crack Inspection, Detection and Analysis on Three Steel Pennsylvania Bridges Using the Electrochemical Fatigue Sensor.” [IBC 07-49] Proceedings and Papers of the 2007 International Bridge Conference. Pittsburgh, Pennsylvania: Engineer’s Society of Western Pennsylvania: (2007).

### 5.3.8 Acknowledgements

Thanks are accorded to the various individuals that provided information included in this paper, including individuals from PennDOT and VDOT. Special thanks are also given to the senior management of MATECH Corp. for their support, input, vision, and encouragement.

## 5.4

## Health Monitoring of Reinforced and Pre-Stressed Concrete Structures Using Time of Flight Information of Guided Waves

*Tribikram Kundu,<sup>5</sup> Tri Huu Miller,<sup>6</sup> Tamaki Yanagita,<sup>7</sup> Julian Grill,<sup>8</sup> and Wolfgang Grill<sup>9</sup>*

### 5.4.1 Introduction

Reinforced concrete (RC) and pre-stressed concrete (PC) makes up a large part of the U.S. and international infrastructure. For instance, over half of the bridge inventory in the U.S. is made of RC (Hatt et al., 2004). Although high alkaline environment of concrete protects steel from corrosion, corrosion does occur and it is currently one of the primary durability concerns for reinforced concrete structures (Al-Sulaimani et al., 1990). Corrosion of RC and PC is a complex phenomenon; it is expensive and the frequency of its occurrence has increased with time. It is therefore very important to monitor corrosion in RC and PC with fewer sensors by generating guided waves that can propagate longer distances in comparison to what is possible today with the current state of technology. This effort will not only reduce the cost of maintenance of the civil infrastructures but also ensure the improved security and enhanced safety of the population.

Current approaches to corrosion monitoring rely on the measurement of the strength of propagating guided waves for corrosion detection. Two types of guided wave modes propagate through corroded bars – one type is sensitive to the bar-concrete interface and the second type is not. Wave modes that have higher energy level near the circumference of the bar are more sensitive to the bar-concrete interface condition and therefore



In recent years, investigators have been using guided ultrasonic waves to measure corrosion damage in reinforced concrete and mortar. In this paper, the feasibility of using time of flight (TOF) information from ultrasonic guided waves to monitor the health of reinforced and pre-stressed concrete structures is investigated. The stress level in a rod can be measured from the TOF information. Corrosion of reinforcing steel and de-lamination between concrete and steel bars are indirectly monitored using the TOF information.

**INFRASTRUCTURE TYPES:** Reinforced and pre-stressed concrete (monitoring)

<sup>5</sup> Department of Civil Engineering & Engineering Mechanics, University of Arizona, Tucson, AZ, USA 85721

<sup>6</sup> Department of Civil Engineering & Engineering Mechanics, University of Arizona, Tucson, AZ, USA 85721

<sup>7</sup> Department of Civil Engineering & Engineering Mechanics, University of Arizona, Tucson, AZ, USA 85721

<sup>8</sup> Department of Mechanical Engineering, RWTH Aachen, Templergraben 55, 52062 Aachen, Germany

<sup>9</sup> Institut Für Experimentelle Physik II, Universität Leipzig, Linnéstr. 5, D-04103 Leipzig, Germany

Current approaches to corrosion monitoring rely on the measurement of the strength of propagating guided waves for corrosion detection.

can easily detect the corrosion induced damage at the interface. However, these modes cannot propagate a long distance through a rebar because the rib patterns of the rebar significantly attenuate these wave modes. On the other hand, the wave modes with higher energy level near the central axis of the bar although are not significantly attenuated by the surface texture of the rebar are insensitive

to the interface corrosion. Thus, with the current state of technology for monitoring corrosion damage at the concrete-rod interface one must place transmitters and receivers relatively close to each other. Another limitation of the current state of technology is that the transmitted signal strength can decrease as well as increase with corrosion.

Transmitted signal strength decays with corrosion because of the increased surface roughness of the corroded rod. However, corrosion can also cause pitting and spalling, resulting delamination between concrete and rebar. Because of delamination less energy leaks into concrete and a stronger transmitted signal is obtained.



Transmitted signal strength decays with corrosion because of the increased surface roughness of the corroded rod.

Bonding condition between the transducers and the specimen can also affect the strength of the received signal. Over time the bonding condition is bound to be affected and thus the received signal strength is going to alter even in absence of any corrosion. Therefore, one cannot say for sure whether an increase (or decrease) of the transmitted signal strength is an indication of corrosion or not.



To avoid these shortcomings associated with the signal strength monitoring, this paper investigates the feasibility of detecting corrosion from the time of flight (TOF) variation.

To avoid these shortcomings associated with the signal strength monitoring, this paper investigates the feasibility of detecting corrosion from the time of flight (TOF) variation. Note that although the received signal strength is affected by the bonding condition between the transducer and the specimen the TOF is not sensitive to it. When the reinforced beam is loaded the stress transferred to the reinforcing rods depends on the rod-concrete interface condition. For a good interface, maximum stress is transferred from concrete to the rod

but for a weak interface partial slippage at the interface may result in a lower level of stress transfer. If the change in TOF due to this stress variation can be detected then corrosion can be monitored from the TOF measurement. Experimental results presented in this paper show that it is possible to detect change of stress level in rods from the TOF variation.

## 5.4.2 Corrosion Of Reinforcing Bars

To effectively deal with corrosion in RC and PC structures, one must first understand the process. A model has previously been set forth for the corrosion process in RC structures (Tuutti 1982). Progression of the corrosion damage in RC with time is outlined in Figures 5-37 and 5-38 following the works of Rostam 2003, Morcouc and Lounis 2005, Zhou et al., 2005, Ervin and Reis 2008. Most common measure of the corrosion damage in RC is the mass loss. However, other parameters such as corrosion-induced cracks, deflection, spalling, flexural capacity, shear capacity and compressional capacity can also be used to quantify corrosion damage.

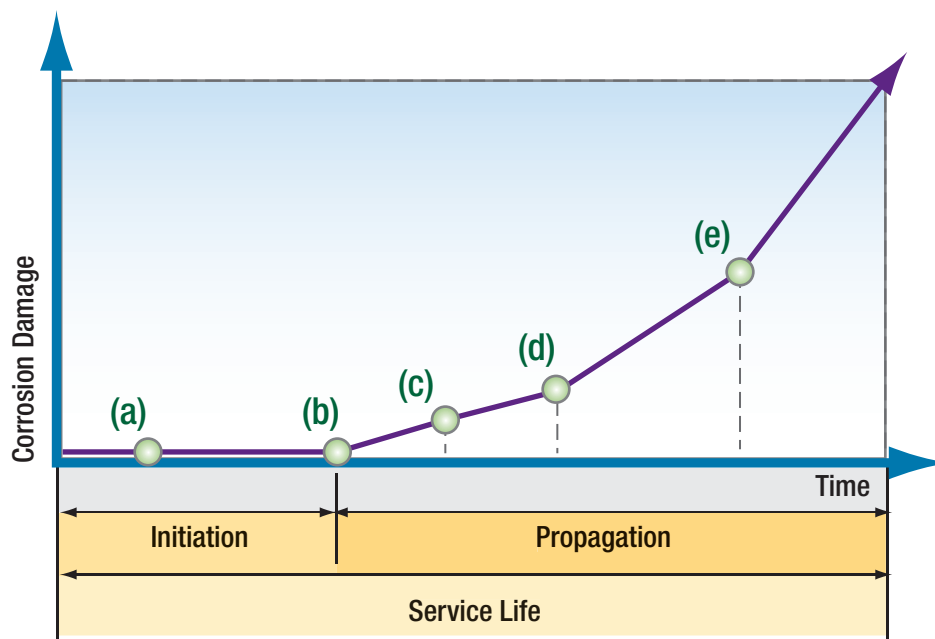

Figure 5-37: Progression of corrosion damage with time in reinforced concrete. Points (a) through (e) are located at different stages of the corrosion process and are illustrated in Figure 5-38 (after Ervin and Reis 2008).

When bare steel is initially exposed to oxygen and water, it forms a very thin (1 mm) dense layer of either metal oxide or hydroxide on its surface (Bazant 1979). This film, referred to as the passive layer, protects the steel while it is contained in the proper environment. The initiation period shown in Figure 5-37 is the amount of time that the passive layer on the embedded steel is protected by the highly alkaline environment of the surrounding concrete. Therefore, the length of the initiation period is determined by the amount of time that the deleterious substances (e.g., chlorides and carbon dioxide) take to ingress through the concrete pore structure and/or cracks and reach a critical threshold at the reinforcement depth. Both chlorides and carbon dioxide can eventually destroy the passive layer and initiate corrosion.



Chlorides and carbon dioxide can eventually destroy the passive layer and initiate corrosion.

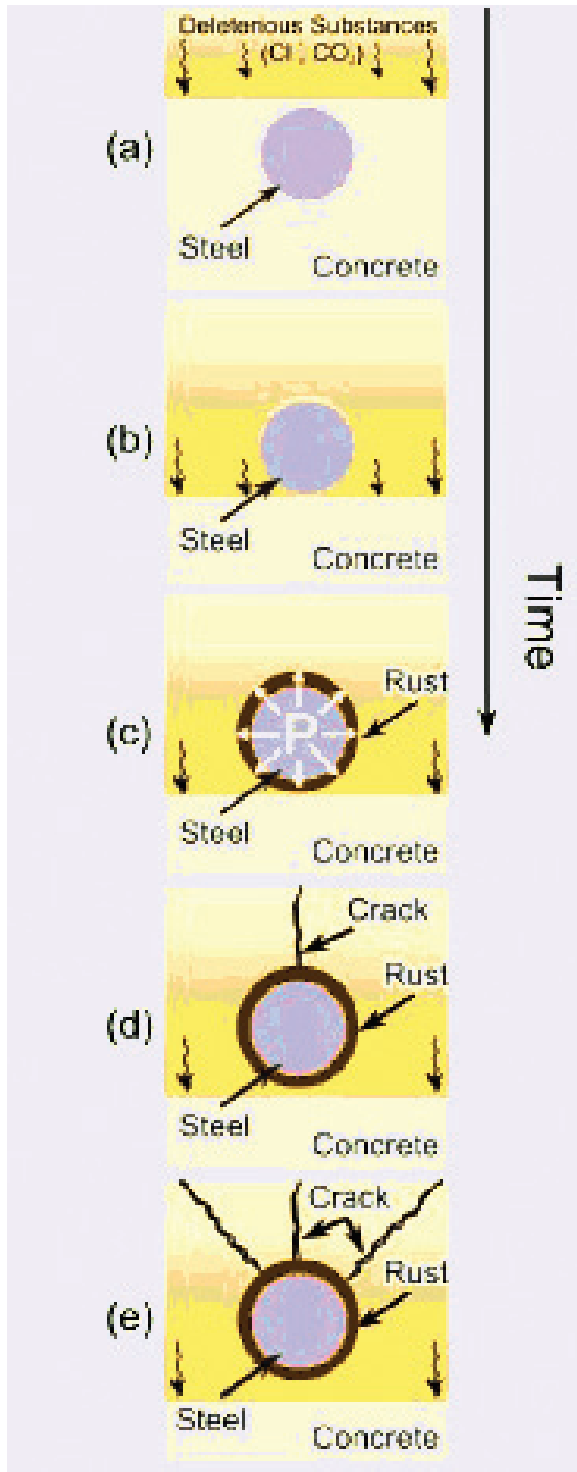

Figure 5-38: Progressive stages of corrosion process in RC structure. Points a through e are located in different stages of the corrosion process model shown in Figure 5-37 (after Ervin and Reis 2008).

### 5.4.3 Corrosion Monitoring by Ultrasonic Guided Waves: Current State of Knowledge

Guided wave based techniques have been found to be very efficient for damage detection and condition assessments of various structures [Rokhlin 1980, Nagy and Adler 1989, Mal et al. 1990, Alleyne and Cawley 1995, Rose et al. 1996, 1998, Ghosh et al. 1998; Guo and Kundu 2000, 2001; Jung et al. 2001, 2002, Na et al. 2002, 2003, Popovics 2003, Mal 2004, Reis et al. 2005, Banerjee et al. 2006, Hosten and Castings 2006, Ervin et al. 2006, 2008, Shin et al. 2007, 2008, di Scalea and Salamone 2008, Michaels 2008, Vasiljevic et al. 2008, Ahmad et al. 2009, Miller et al. 2009]. One major advantage of the guided wave based technique is that it can detect damage from a much greater distance unlike conventional electromagnetic, optical or chemical sensing techniques [Ghandehari and Khalil 2005, Vimer 2009] for which the probes must be close to the inspection region. As a result the guided wave based techniques are gaining popularity for inspection of large civil structures.

The following two facts are exploited by the investigators for sensing corrosion using guided waves:

- 1) Corrosion makes the surface of the reinforcing steel bars rough
- 2) Corrosion eventually causes delamination between concrete and steel rebar

Figure 5-39 shows four steel bars with various degrees of corrosion. Clearly surface roughness increases with corrosion. Figure 5-40 shows how the strength of the transmitted guided wave decays as the degree of corrosion increases in these 3-foot-long bars.



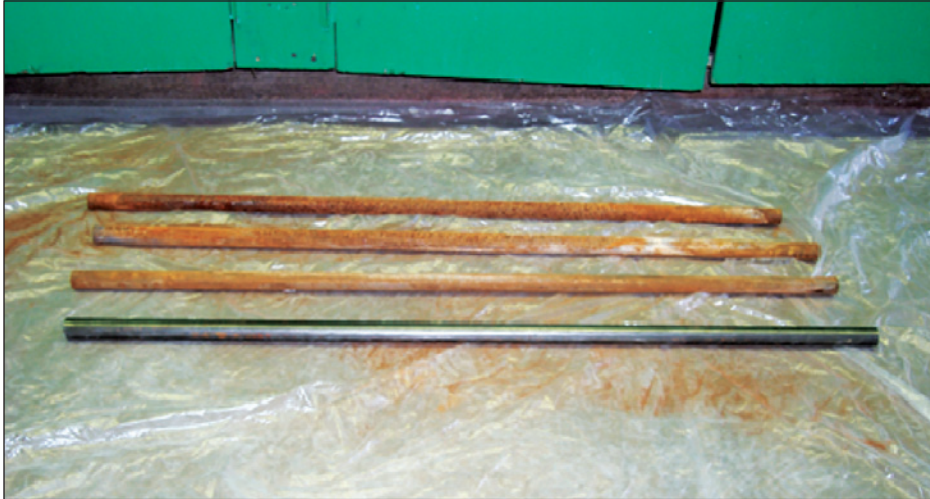

Figure 5-39:  
Four steel bars showing  
different degrees of corrosion  
– un-corroded case (bottom  
bar) to highly corroded case  
(top bar).

To study the effect of delamination on the propagating wave strength artificial separations of various lengths between concrete and rod were fabricated (Miller et al. 2009). Typical specimen recorded signal strengths, in Figure 5-41.

From Figures 5-40 and 5-41 it is evident that with increasing corrosion the signal strength decreases but with higher level of separation between concrete and steel (which is also caused by corrosion) the signal strength increases. Therefore, when both these phenomena take place simultaneously the net signal strength may increase or decrease depending on which effect is stronger.

Investigators have corroded steel bars inside concrete and studied the strengths of transmitted guided wave modes as the corrosion progresses [Ervin and Reis 2008]. Not surprisingly what they have observed is that the guided wave modes that strongly excite the circumference of the rod are more sensitive to the corrosion damage at the rod-concrete interface while the modes that have higher levels of energy concentrated near the central axis of the rod are less sensitive to the concrete-steel interface corrosion but propagate longer distances through the rod. This is the current state of knowledge on the guided wave inspection technique.

Figure 5-40:

Received guided wave strength after the wave propagated through four 3-foot long steel bars with different degrees of corrosion (see Figure 5-39) in concrete. Note how the surface roughness due to corrosion attenuates the propagating wave (after Miller et al. 2009)

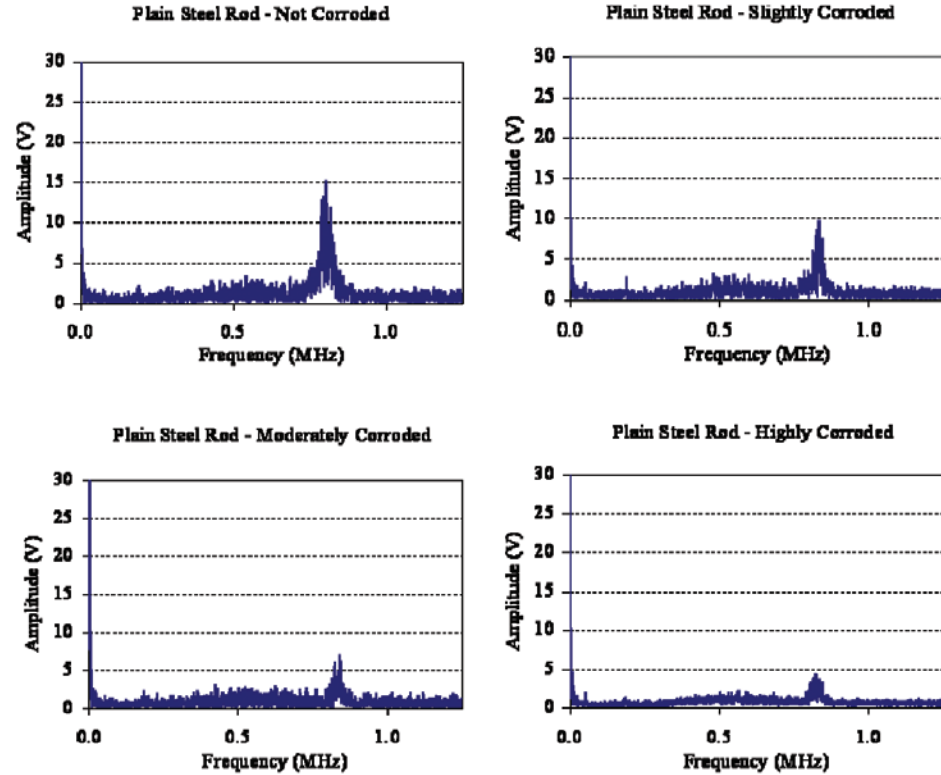
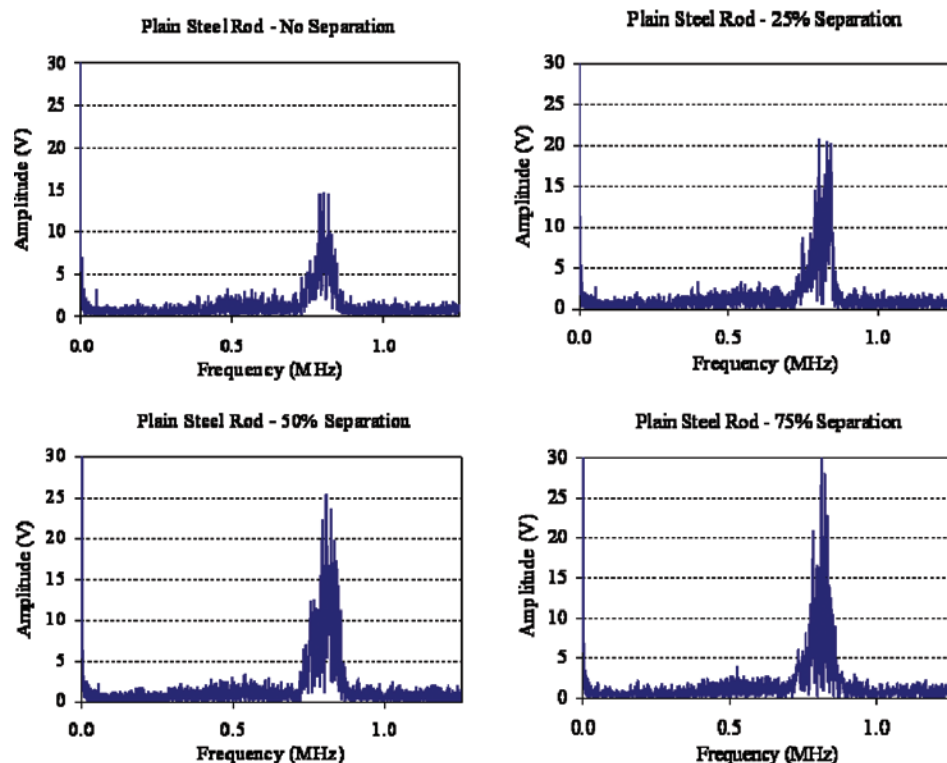

Figure 5-41:

Received guided wave strength after the wave propagated through four reinforced concrete specimens with different degrees of separation between the steel rod and the concrete. Specimen dimensions are shown in Figure 5-41. Higher level of separation increases the signal strength because less energy can leak into concrete as concrete is detached from the rebar (after Miller et al. 2009).



The state of the art of using guided waves for condition assessment of reinforcing bars is illustrated in Figure 5-42. Two guided wave modes A and B are shown to propagate through the steel rod from transmitter T to receiver R. For mode A the energy profile is such that most of the energy propagates near the circumference of the rod while for mode B the energy is confined near the central core of the rod. Mode A is more sensitive to the interface condition and should be strongly affected by the corrosion at the steel/concrete interface. However, the energy profile of mode A also causes more energy leaks into the surrounding concrete resulting in a higher attenuation. Mode B on the other hand can propagate a longer distance through the rod due to low level of energy leaking into concrete. However, this mode is less sensitive to the interface condition.

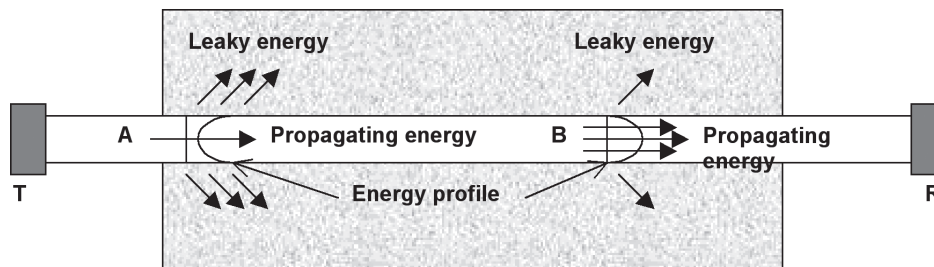

Figure 5-42: Two guided wave modes A and B are propagating from the transmitter T to receiver R. Energy profile of mode A makes it more sensitive to the interface condition (corrosion etc.) but also let more energy leaking into surrounding concrete. The situation is reverse for mode B.

Besides the problem of energy leaking into the surrounding medium another major difficulty with the propagating mode A is that when the plain steel bar is replaced by a rebar (see Figure 5-43) mode A has even harder time to propagate through the rebar because of its sensitivity to the surface texture of the rebar. Therefore, the dilemma here is whether to choose mode A or mode B. Energy profile of mode A makes it more sensitive to the interface condition but it adversely affects the ability of this mode to propagate through a rebar because of its non-uniform surface texture. Surface corrugation scatters away the propagating energy. Investigators try to select an optimum mode whose characteristics are between modes A and B. This optimum mode is reasonably sensitive to the interface condition and at the same time should be able to propagate a relatively long distance along the rebar.

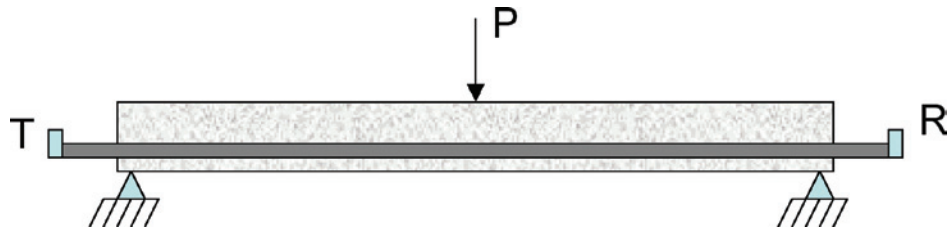

Figure 5-43: A typical rebar used for concrete reinforcement. Note the non-uniform cross-section.

### 5.4.4 Corrosion Monitoring by Ultrasonic Guided Waves: From TOF (Time Of Flight) Information

To enable the guided waves travelling a long distance through corroded and corrugated rods or rebars one needs to use wave modes that have the energy profile of type B, shown in Figure 5-42. The fact that this mode is less sensitive to the concrete-steel interface condition is good news for its long distance propagation capability but bad news for its corrosion detection capability. This shortcoming can be overcome by loading the beam as shown in Figure 5-44. If the steel rod is located away from the neutral axis then it will be under tension for the loading shown in the figure. When the bonding between concrete and steel is perfect (no slippage at the interface) then the steel rod experiences maximum tensile stress. As the bonding between steel rod and concrete deteriorates due to corrosion the tensile stress in steel should decrease and finally when the bonding completely breaks down causing full separation the tensile stress in the steel rod becomes zero. Since the wave speed varies with the applied stress the TOF of the guided wave propagating from transmitter T to receiver R should depend on the stress level in the rod. Note that the velocity of both modes A and B of Figure 5-42 will be affected by the stress level in the rod. Therefore, it is not necessary to select mode A that attenuates fast. Instead it is advisable to monitor the TOF of mode B that can propagate a long distance through the rod and at the same time be sensitive to the corrosion at the interface since the stress level in the rod depends on the interface corrosion.

Figure 5-44:  
Reinforced beam is loaded by a transverse load P. Guided wave is sent from transmitter T to receiver R through the steel rod of this loaded beam.



#### 5.4.4.1 Experimental Results

To investigate how reliably one can record the change in TOF due to the applied load, a free steel rod in absence of any concrete is simply supported at its two ends and loaded at the midpoint as shown in Figure 5-45.

A 700 g hanger is placed at the midpoint of the steel rod; then 1 to 5 kg load is applied and removed with an increment of 1 kg. The load variation with time is shown in Table 5-11. The complete loading/unloading cycle takes 17 minutes as shown in Table 5-11. The Change in TOF as a function of time is plotted in Figure 5-46. Note that as soon as the hanger

is placed on the rod the TOF is reduced by 10 to 12 ns (nanoseconds). As more weights are placed on the hanger the TOF is reduced further and when the load is removed the TOF goes back to its previous level. Clearly the small variation of TOF due to the applied load is experimentally detectable.

It should be noted here that for the loading shown in Figure 5-45 the upper half of the steel rod (above the neutral axis) is under compression and the lower half (below the neutral axis) is under tension. Because of this combined tensile-compressive stresses the net change of the rod length is negligible. Tensile and compressive stresses alter (increase or decrease) the wave speed. If the wave in the tensile zone travels faster in comparison to that in the unstressed material, part of the energy will arrive at the receiver earlier when the rod is loaded, even though the wave speed in the compressive region is lower. This is observed in Figure 5-46. In this figure along the y-axis TOF is plotted relative to a reference time. Negative value (-65 n) means the signal arrived 65 ns before the reference time. Note that as the 700 g hanger and 5 kg load are applied the TOF is reduced by 40 ns  $[-105 - (-65)]$ . The TOF variation is measured by the cross-correlation technique applied to the receiving signals for unloaded and loaded rods.

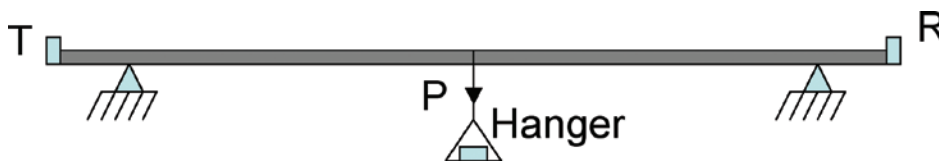

Figure 5-45: A steel rod is loaded by a transverse load  $P$  by placing weights on the 700 g hanger. Guided wave is sent through the rod from transmitter  $T$  to receiver  $R$ .

After the encouraging results of Figure 5-46 the steel rod or bar is placed in the concrete beam which is loaded at the midpoint, as shown in Figure 5-44, up to 125 lb with an increment of 25 lb and then unloaded to zero at 25 lb steps, as illustrated in Table 5-12. Loading-unloading cycle takes 11 minutes. TOF variations for corroded and non-corroded rebars placed in concrete beams are shown in Figures 5-47 (a) and (b), respectively. Note that the TOF increases by almost 35 ns for the corroded rebar and 22 ns for the non-corroded rebar.

In this experiment the rebar was corroded outside the concrete and then concrete was poured around the corroded and non-corroded rebars. Rough surface of the corroded rebar produced a good bonding between concrete and bar and thus a better stress transfer occurred from concrete to the rebar for the corroded case causing relatively larger variation in TOF measurement. For this loading the bar was subjected to the tensile stress only, causing an increase in its length and the TOF of the propagating wave.

Table 5-11: Applied load as a function of time. H stands for 700 g hanger.

Time, min	1	2	3	3.5	4.5	5	6	6.5	7.5	8	9	9.5	10.5	11	12	12.5	13.5	14	15	16	17
Load, kg	0	H	1.0	H	2.0	H	3.0	H	4.0	H	5.0	H	4.0	H	3.0	H	2.0	H	1.0	H	0

Figure 5-46: Time of flight variation for a plain steel rod during loading-unloading cycles described in Table 5-11. Figure 5-45 shows how the load is applied on the steel rod. Horizontal axis shows the clock time and the vertical axis shows the TOF in ns relative to a reference time. Negative sign implies earlier arrival than the reference time (after Miller et al. 2009).

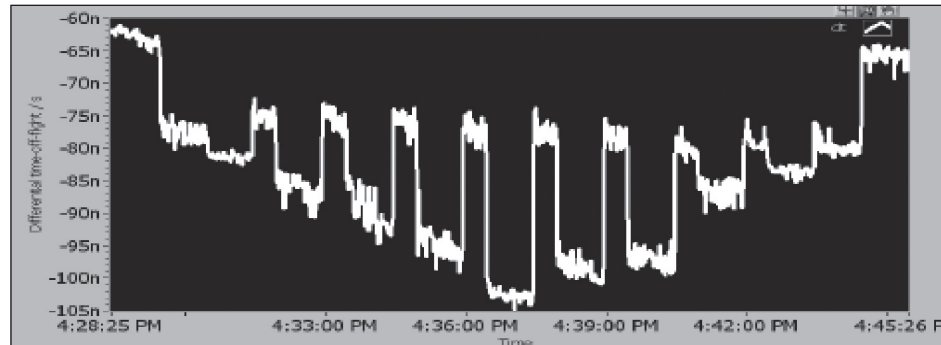

Next it was investigated if increasing the load increment by a factor of 2 whether the TOF variation also increases by a factor of 2. To this aim the non-corroded reinforced beam specimen was loaded up to 250 lb with 50 lb increment and then unloaded to zero as shown in Table 5-13. Loading-unloading cycle took 11 minutes. The TOF variation with time is shown in Figure 5-48. The TOF increased by 50 ns for 250 lb loading while it had increased by only 22 ns for 125 lb loading, see Figure 5-47b.

### 5.4.5 Conclusions

Experimental results obtained in the bond assessment study show that the guided ultrasonic waves can detect corrosion and separation at the interface of reinforcing steel and concrete in reinforced concrete members. Results show that different signal amplitudes are obtained for specimens with different degrees of separation and corrosion. Experimental results suggest that the signal amplitude received at the other end of plain steel bars increases with the amount of separation and decreases with the amount of corrosion. When the surrounding medium is air, little energy leaks from the steel bar into the air. When the bar is in good contact with the surrounding concrete then the ultrasonic energy leaks into concrete, and the received signal strength decays.

Experimental results obtained in the bond assessment study show that the guided ultrasonic waves can detect corrosion and separation at the interface of reinforcing steel and concrete in reinforced concrete members.

The results from the time-of-flight investigation (change in the signal arrival time due to applied stress) clearly show the dependence of the TOF on the applied load. The applied load causes bending stresses in the free steel bar and almost pure tension in steel bars embedded in the tensile

zone of the concrete. It is observed that the TOF is reduced with the applied load for free steel bars and increased for embedded bars. Increase in TOF for embedded bars can be easily justified – the steel bar in the tensile zone is elongated and as a result the TOF is increased. Wu and Chang (2006) also observed an increase in TOF when the reinforcing bars are subjected to tension. However, it is not so obvious why the TOF decreases when a free bar is subjected to bending. Since the bar length is not changed under bending only logical conclusion that can be drawn from this observation is that the stress (tensile below the neutral axis and compressive above the neutral axis) makes the wave speed higher in the rod causing a reduction in TOF. Sensitivity of TOF to internal stresses in rebars can be used for condition assessment of pre-stressed rods in concrete. Corrosion affects the stress level in a rebar and thus can be monitored from the TOF measurement.

### 5.4.6 Acknowledgement

Partial financial support from the NSF grants OISE-0352680 and CMMI-0530991 for this research is gratefully acknowledged. The second author is also in deep gratitude to Rick Engineering Company, Inc. for its continuous support.

Table 5-12 shows variation of the applied load as a function of time for the loading shown in Figure 5-44. TOF variation for this loading history is shown in Figure 5-47.

**Table 5-12: Variation of the applied load as a function of time for the loading shown in Figure 5-44.**

Time, min	1	2	3	4	5	6	7	8	9	10	11
Load, kg	0	25	50	75	100	125	100	75	50	25	0

**Figure 5-47:**  
Variation of TOF of the guided wave propagating through the steel rebar placed in the reinforced concrete beam for the load variation shown in Table 5-12. (a) corroded rebar, (b) non-corroded rebar (after Miller et al. 2009)

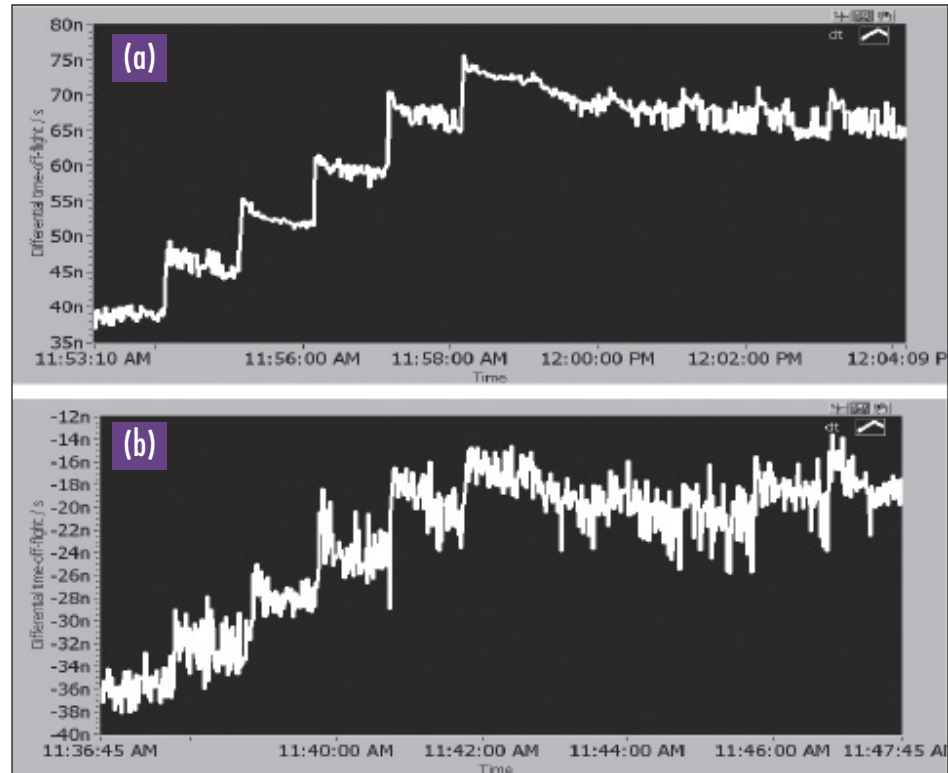
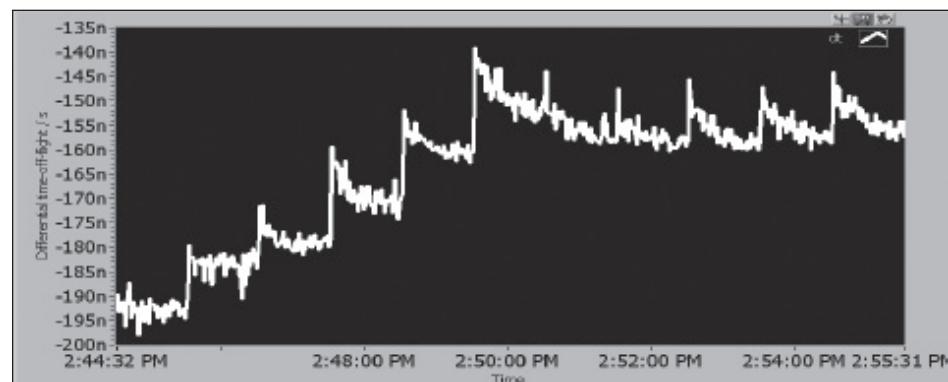

Table 5-13 shows variation of the applied load as a function of time for the loading shown in Figure 5-44. TOF variation for this loading history is shown in Figure 5-48.

**Table 5-13:** Variation of the applied load as a function of time for the loading shown in Figure 5-44.

Time, min	1	2	3	4	5	6	7	8	9	10	11
Load, kg	0	50	100	150	200	250	200	150	100	50	0

**Figure 5-48:**  
Variation of TOF of the guided wave propagating through a non-corroded steel rebar placed in the reinforced concrete beam for the load variation shown in Table 5-13 (after Miller et al. 2009).





### 5.4.7 References

Ahmad, R., S. Banerjee and T. Kundu (2009) "Pipe Wall Damage Detection in Buried Pipes using Guided Waves," ASME Journal of Pressure Vessel Technology, Vol. 131(1), pp. 011501-1 to 8.

Alleyne, D. and P. Cawley (1995) "The Long Range Detection of Corrosion in Pipes Using Lamb Waves," Review of Progress in Quantitative Nondestructive Evaluation, Eds. D. O. Thompson and D. E. Chimenti, Pub. Plenum Press, New York, Vol. 14, pp. 2073-2080.

Al-Sulaimani, G. K., M. Kaleemullah, I. A. Busanbul and F. Rasheeduzzafar (1990) "Influence of Corrosion and Cracking on Bond Behavior and Strength of Reinforced Concrete Members," ACI Structural Journal, Vol. 87, pp. 220-231.

Banerjee, S., F. Ricci, F. Shih and A. Mal (2006) *Chapter 2: Health Monitoring of Composite Structures Using Ultrasonic Guided Waves*, Advanced Ultrasonic Methods for Material and Structure Inspection, Ed. T. Kundu, Pub. ISTE, London, U.K. p.43.

Bazant, Z. P. (1979) "Physical Model for Steel Corrosion in Concrete Sea Structures – Theory," Journal of Structural Division – ASCE, Vol. 105, pp. 1137-1153.

di Scalea, F. L. and S. Salamone (2008) "Temperature Effects in Ultrasonic Lamb Wave Structural Health Monitoring Systems," Journal of the Acoustical Society of America, Vol. 124(1), pp. 161-174

Ervin, B. L., J. T. Bernhard, D. A. Kuchma and H. Reis (2006) "Estimation of General Corrosion Damage to Steel Reinforced Mortar using Frequency Sweeps of Guided Mechanical Waves," Insight, Vol. 48(11), pp. 682-692.

Ervin, B. L., D. A. Kuchma, J. T. Bernhard and H. Reis (2009) "Monitoring Corrosion of Rebar Embedded in Mortar using High-Frequency Guided Ultrasonic Waves," Journal of Engineering Mechanics – ASCE, Vol. 135(1), pp. 9-19

Ervin, B. L. and H. Reis (2008) "Longitudinal Guided Waves for Monitoring Corrosion in Reinforced Mortar," Measurement Science & Technology, Vol. 19(5), Article Number 055702

Ghandehari, M. and G. Khalil (2005) "Materials Health Management by in situ Chemical Analysis," Materials Evaluation, Vol. 63(7), pp. 724-730

Ghosh, T., and T. Kundu (1998). "A New Transducer Holder Mechanism for Efficient Generation and Reception of Lamb Modes in Large Plates," *Journal of the Acoustical Society of America*, Vol. 104, pp. 1498-1502

Ghosh, T., T. Kundu and P. Karpur (1998). "Efficient Use of Lamb Modes for Detecting Defects in Large Plates," *Ultrasonics*, Vol. 36, pp. 791-801

Guo, D. and T. Kundu (2000) "A New Sensor for Pipe Inspection by Lamb Waves," *Materials Evaluation*, Vol. 58(8), pp. 991-994

Guo, D., and T. Kundu (2001) "A New Transducer Holder Mechanism for Pipe Inspection," *Journal of the Acoustical Society of America*, Vol. 110, pp. 303-309

Hartt, W. H., R. G. Powers, V. Leroux and D. K. Lysogorski (2004) "Critical Literature Review of High-Performance Corrosion Reinforcements in Concrete Bridge Applications," *Federal Highway Administration Report (FHWA-RD-04-093)*.

Hosten, B. and Castaings, M. (2006), *FE Modeling of Lamb Mode Diffraction by Defects in Anisotropic Viscoelastic Plates*, *NDT&E International*, Vol. 39, p. 195.

Jung, Y.C., T. Kundu and M. Ehsani (2001) "Internal Discontinuity Detection in Concrete by Lamb Waves," *Materials Evaluation*, Vol. 59(3), pp. 418-423.

Jung, Y. -C., T. Kundu and M. R. Ehsani (2002) "A New Nondestructive Inspection Technique for Reinforced Concrete Beams," *ACI Materials Journal*, Vol. 99(3), pp. 292-299

Mal, A. (2004), "Structural Health Monitoring," *Mechanics, The American Academy of Mechanics*, Vol. 33, No. 11-12.

Mal, A. K., P. C. Xu and Y. Bar-Cohen (1990) "Leaky Lamb Waves for the Ultrasonic Nondestructive Evaluation of Adhesive Bonds," *Journal of Eng. Mat. Tech.* Vol. 112, pp. 255-259.

Michaels J. E. (2008) "Detection, Localization and Characterization of Damage in Plates with an in situ Array of Spatially Distributed Ultrasonic Sensors," *Smart Materials and Structures*, Vol. 17(3), Article Number 035035

Miller, T. H., T. Yanagita, T. Kundu, J. Grill and W. Grill (2009) "Nondestructive Inspection of Corrosion and Delamination at the Concrete-Steel Reinforcement Interface," *Health Monitoring of Structural and Biological Systems III*, Ed. T. Kundu, SPIE's 16th Annual International

Symposium on Smart Structures and Materials & Nondestructive Evaluation and Health Monitoring, San Diego, California, March 9-12, Vol. 7295.

Morcous, G. and Z. Lounis (2005) "Prediction of Onset of Corrosion in Concrete Bridge Decks using Neural Networks and Case-Based Reasoning," *Computer Aided Civil Infrastructure Engineering*, Vol. 20, pp. 108-117

Na, W.B., T. Kundu and M. Ehsani (2002), "Ultrasonic Guided Waves for Steel Bar-Concrete Interface Testing," *Materials Evaluation*, Vol. 60(3), pp. 437-444.

Na, W. -B. and T. Kundu (2002), "A Combination of PZT and EMAT for Interface Inspection," *Journal of the Acoustical Society of America*, Vol. 111(5), pp. 2128-2139

Na, W.B. and T. Kundu (2002), "Underwater Pipe Inspection using Guided Waves," *ASME Journal of Pressure Vessel Technology*, Vol. 124(2), pp. 196-200.

Na, W.B. and T. Kundu (2002), "Wave Attenuation in Pipes and its Application in Determining Axial Spacing of Monitoring Sensors," *Materials Evaluation*, Vol. 60(5), pp. 635-644

Na, W. B. and T. Kundu (2003), "Inspection of Interfaces between Corroded Steel Bars and Concrete by PZT-EMAT Combination," *Journal of Experimental Mechanics*, Vol. 43(1), pp. 24-31.

Na, W. B., T. Kundu and M. Ehsani (2003), "A Comparison of Steel-Concrete and GFRP-Concrete Interface Inspection by Guided Waves," *Materials Evaluation*, Vol. 61(2), pp. 155-161.

Na, W.B., T. Kundu and M. Ehsani (2003) "Lamb Waves for Detecting Delamination between Steel Bars and Concrete," *Computer-Aided Civil and Infrastructure Engineering*, Vol. 18, pp. 57-62.

Nagy, P. B. and L. Adler (1989) "Nondestructive Evaluation of Adhesive Joints by Guided Waves," *Journal of Applied Physics*, Vol. 66, pp. 4658-4663

Popovics J. S. (2003) "Nondestructive Evaluation: Past, Present, and Future," *Journal of Materials in Civil Engineering*, Vol. 15(3), pp. 211

Reis, H., B. L. Ervin, D. A. Kuchma and J. T. Bernhard (2005) "Estimation of Corrosion Damage in Steel Reinforced Mortar using Guided Waves," *Journal of Pressure Vessel Technology – Transactions of the ASME*, Vol. 127 (3), pp. 255-261.

Rokhlin, S. I. (1980) "Diffraction of Lamb Waves by a Finite Crack in an Elastic Layer," *Journal of the Acoustical Society of America*, Vol. 67(4), pp. 1157-1165.

Rose, J. L., D. Jiao and J. Spanner (1996) "Ultrasonic Guided NDE for Piping," *Materials Evaluation*, Vol. 54(11), pp. 1310-1313.

Rose, J. L., W. Zhu and M. Zaidi (1998) "Ultrasonic NDE of Titanium Diffusion Bonding with Guided Waves," *Materials Evaluation*, Vol. 56(4), pp. 335-339

Rostam, S. (2003) "Reinforced Concrete Structures – Shall Concrete Remain the Dominating Means of Corrosion Prevention?," *Mater. Corrosion*, Vol. 54, pp. 369-378.

Shin, S. W., J. Y. Zhu, J. Min and J. S. Popovics (2008) "Crack Depth Estimation in Concrete using Energy Transmission of Surface Waves," *ACI Materials Journal*, Vol. 105(5), pp. 510-516.

Shin, S. W., C. B. Yun, J. S. Popovics and J. H. Kim (2007) "Improved Rayleigh Wave Velocity Measurement for Nondestructive Early-Age Concrete Monitoring," *Research in Nondestructive Evaluation*, Vol. 18(1), pp. 45-68.

Tuutti, K. (1982) *Corrosion of Steel in Concrete*, Swedish Cement and Concrete Research Institute.

Vasiljevic, M., T. Kundu, W. Grill and E. Twerdowski (2008), "Pipe Wall Damage Detection by Electromagnetic Acoustic Transducer Generated Guided Waves in Absence of Defect Signals," *Journal of the Acoustical Society of America*, Vol. 123(5), pp. 2591-2597.

Vimer, C., Yu, S. and M. Ghandehari (2009) "Probing pH Levels in Civil Engineering Materials," *Journal of Materials in Civil Engineering*, Vol. 21(2), pp. 51-57

Wu F and Chang F K (2006) Debond detection using embedded piezoelectric elements in reinforced concrete structures – Part I: Experiment *Struct. Health Monit. Vol. 5*, pp. 5-15

Zhou, K., B. Martin-Perez and Z. Lounis (2005) "Finite Element Analysis of Corrosion-Induced Cracking, Spalling and Delamination of RC Bridge Decks," 1st Canadian Conference on Effective Design of Structures (Ontario, Canada), pp. 187-196.

## 5.5

## A Hierarchical Fuzzy Expert System for Risk of Failure of Water Mains

*Hussam Fares<sup>10</sup> and Tarek Zayed<sup>11</sup>*

### 5.5.1 Introduction

The water distribution system is considered to be the most expensive part of water supply system (Giustolisi et al., 2006). In a recent survey conducted by the United States Environmental Protection Agency, it is estimated that \$77 billion will be needed to repair and rehabilitate the water main over the next 20 years (Selvakumar et al., 2002). In Canada and the United States, there have been more than 2 million breaks since January 2000, with an average of 700 water main breaks every day, costing more than 6 billion Canadian dollars in repair costs (Infrastructure Report, 2007). Moreover, providing communities with reliable and safe water has become increasingly a topic of concern. Water distribution networks are buried pipelines and as a result, they have received little attention from decision makers. Breakage rate and the high associated cost of failure have reached a level that now draws the attention of both public and decision makers. As a result, dealing with the risk of water main failure has been undergoing a great change in concept from reacting to failure events to taking preventive actions that maintain the water main in good working condition.

The risk of failure is defined as the combination of the probability and the impact severity of a particular circumstance that negatively affects the ability of infrastructure assets to meet the objectives of the municipality (InfraGuide, 2006). Risk factors for water main failure can be divided broadly into deterioration and consequence (post failure) factors. The deterioration factors are either responsible for deterioration



In Canada and the United States, there are an average of 700 water main breaks every day, costing more than 6 billion

Canadian dollars in repairs since 2000. Risk of failure is the combination of the probability and the impact severity of a particular circumstance that hinders the ability of an infrastructure asset to meet the objectives of the municipality. This paper discusses the design of a framework to evaluate the risk of water main failure using a hierarchical fuzzy expert system (HFES). A set of water network real data is used as a case study to examine the developed HFES. According to the proposed scale of failure risk, about 13 km of the case study network's pipelines are at risk and require mitigation in the short-term.

**INFRASTRUCTURE TYPE:** Water distribution

<sup>10</sup> Former Graduate Student, Department of Building, Civil, and Environmental Engineering, Concordia University, Montreal, Quebec, Canada. E-mail: hussamfa@hotmail.com

<sup>11</sup> Associate Professor, Department of Building, Civil, and Environmental Engineering, Concordia University, Montreal, Quebec, Canada. E-mail: zayed@encs.concordia.ca



Municipalities and other authorities must build long and short-term management plans that prioritize the rehabilitation of water works within their limited budgets in order to upgrade the status of their water main networks. These strategies should be built on scientific approaches that consider the risk of pipeline failure in tandem with all of the failure factors.

of the potable water distribution network or they can give an indication of the level of network deterioration. Environmental, physical, and operational factors are included within the deterioration framework. Consequence or post failure factors represent the cost of water main failure and should be considered when evaluating the risk of pipeline failure. Municipalities and other authorities must build long and short-term management plans that prioritize the rehabilitation of water works within their limited budgets in order to upgrade the status of their water main networks. Thus, it is crucial to apply management strategies to upgrade, repair, and maintain the potable water network. These strategies should be built on scientific approaches that consider the risk of pipeline failure in tandem with all of the failure factors.

A new model to evaluate the risk of water main failure is proposed in this paper. Deterioration factors that lead to the failure event and the consequence factors that result from the failure event (failure impact) are considered in this research. In order to guide the water main management team to the best management plan, a risk scale of failure is proposed that highlights a water main at various risk stages.

The objectives of the current research can be summarized as follows:

- Design a risk model of water main failure to evaluate the risk associated with each pipeline in the network.
- Propose a risk scale of failure that provides guidance to decision makers.

### 5.5.2 Literature Review

Distribution networks often account for up to 80% of the total expenditure involved in water supply systems (Kleiner and Rajani, 2000). The breakage rates of the water main increase and their hydraulic capacity decreases as they deteriorate. Risk is defined by InfraGuide (2006) as the combination of the probability and impact severity of a particular circumstance that negatively impacts the ability of infrastructure assets to meet the objectives of the municipality. Moreover, the probability is defined as the likelihood of an event occurring. Risk assessment tries to answer the questions (Kirchhoff and Doberstein, 2006): what can

Distribution networks often account for up to 80% of the total expenditure involved in water supply systems.

go wrong?, what is the likelihood that it would go wrong?, and what are the consequences?

### 5.5.2.1 Failure of Water Distribution System

Pipeline failure is defined as the inability to satisfy basic requirements from the distribution system, failure to satisfy customer demand or failure to maintain pressures within specific limits. The types of water distribution failure can be categorized into: 1) performance failure and 2) mechanical failure (Ozger, 2003). In this paper, only the risk of mechanical failure of water main is studied. The mechanical failure factors are summarized as static, dynamic and operational. Static factors can include material, diameter, wall thickness, soil, and installation during construction. Dynamic factors include age, soil and water temperatures soil moisture, soil electrical resistivity, bedding condition, and dynamic loads. Operational factors include replacement rates, cathodic protection and water pressure (Kleiner and Rajani, 2000; Kleiner and Rajani, 2002; Kleiner et al., 2006; Pelletier et al., 2003). Sources of risks can be categorized into five groups (InfraGuide, 2006): (1) natural occurring events, such as fire, storm, flood, and earthquake; (2) external impacts as a result of failure by an outside party, such as power failure, spills, labor strike; (3) aggressions due to acts of vandalism or terrorism that results in destruction of critical asset; (4) aging Infrastructure and Physical deterioration; and (5) operation risk, which covers the way the infrastructure is designed, managed, and operated.

Risk assessment tries to answer the questions: what can go wrong?, what is the likelihood that it would go wrong?, and what are the consequences?

### 5.5.2.2 Consequences of Failure

A judgment of the potential consequences is inherent in any risk evaluation. This is the answer to the question, if something goes wrong, what are the consequences? Consequence implies some kind of loss. Losses can be quantified into direct costs and indirect costs. Example of the direct costs are property damage, damages to human health, environmental damage, loss of production, repairs costs, cleanup and remediation costs, etc. Several indirect costs include litigation and contract violations, customer dissatisfaction, political reactions, loss of market share, and government fines and penalties (Muhlbauer, 2004; Bhave, 2003). Some of these consequences are monetized in a straight forward process. However, it is more difficult to quantify the indirect consequences in a monetary value (Muhlbauer, 2004). Consequence of failure is different among pipelines and varies with time relative to a business cycle. It is also affected by pipeline flow load and the generated revenue from that pipeline (Nikolaidis et al., 2005).

A judgment of the potential consequences is inherent in any risk evaluation.

### 5.5.2.3 Risk of Water Main Failure

This section provides an overview of the research works and various efforts related to water main failure risk. Christodoulou et al. (2003) used Artificial Neural Networks (ANN) to analyze the preliminary water main failure risk in an urban area with historical breakage data spanning two decades. The outputs of the ANN model are the age to failure, the observation outcome (a break or a non-break), and the relevant weights of the risk factors. Their study indicates that number of previous breakage, material, diameter, and length of pipe segments are the most important risk factors for water main failures. Yan and Vairavamorthy (2003) proposed a methodology to assess pipeline condition using Multi-Criteria Decision Making (MCDM) techniques. The output of the model is a fuzzy number that reflects the condition of each pipeline, which is ranked accordingly. Kleiner et al. (2004) used a fuzzy rule-based, non-homogeneous Markov process to model the deterioration process of buried pipes. The deterioration rate at a specific time is estimated based on the asset's age and condition state using a fuzzy rule-based algorithm. Then, the possibility of failure is estimated for any age of pipeline based on its deterioration model. The possibility of failure is coupled with the consequence of failure through a matrix approach to obtain the failure risk as a function of pipe's age.

Sadiq et al. (2004) developed a method for evaluating the time-dependent reliability of underground grey cast iron water mains and identifying the major factors that contribute to water main failure. The consequence of failure, which is a part of risk calculation, is ignored and here the term "risk" refers solely to the probability of failure. Kleiner et al. (2006) developed a methodology to evaluate pipeline failure risk using the fuzzy logic technique. The model consists of three parts: possibility of failure, consequence of failure and a combination of these two to obtain failure risk. The consequences of failure can be in the form of direct, indirect, and social costs. The risk of failure is assessed by combining the probability of failure with consequences of failure in nine fuzzy triangular subsets. Rajani et al. (2006) used a fuzzy synthetic evaluation technique to translate observations from visual inspection and non-destructive tests into water main condition ratings. Al-Barqawi (2006) designed two condition rating models for water mains using artificial neural networks (ANN) and the analytical hierarchy process (AHP). In this research, only the deterioration factors (physical, operational, and environmental) are considered. The founding results of this research work is that pipe age, pipe material, and breakage rate are the most effective factors in evaluating the current condition of water mains.

Pipe age, pipe material, and breakage rate are the most effective factors in evaluating the current condition of water mains.



Rogers (2006) developed a model to assess water main failure risk. He used the Power Law form of a Non-Homogeneous Poisson Process (NHPP) and Multi-Criteria Decision Analysis (MCDA) based on the Weighted Average Method (WAM) to calculate the probability of failure. The developed model considers the consequence of failure using “what-if” infrastructure investment scenarios.

Based upon the literature review, it is obvious that the research works that have addressed the problem of water main failure risk have certain limitations, and therefore, there is an essential need for a research that addresses the problem with a broad, concrete, and robust approach. Certain researchers have approached the problem in too shallow fashion, considering very few risk factors which sometimes were limited to only the deterioration factors (condition rating) and/or they did not consider the consequence of failure. Moreover, some of these research works were so complicated in their derivation and usage so that different management teams of municipalities and other authorities are reluctant to use and depend on. Other efforts were too specific to certain conditions (such as pipe material, diameter, function, etc...) and thus are not applicable to different water distribution networks. Some examples of these research works were performed by: Yan and Vairavamoorthy (2003), Kleiner et al. (2004), Sadiq et al. (2004), Kleiner et al. (2006), Rajani et al. (2006) and Al Barqawi (2006). The most relevant research was done by Rogers (2006); however, there are some limitations inherent to his research, such as (1) the model uses the weighted average method which does not address the uncertainty and (2) the model is too sensitive to the weights of factors. Moreover, Rogers’ failure consequence model is not well-established and depends solely on the input of the user. In addition, some of the risk factors are derived from a specific data set and seem to be more reflective of that data set instead of reflecting the state of the art. Therefore, it is clear that there is a need to address the problem of water main failure risk using a technique, such as fuzzy logic, that considers the uncertainty usually associated with risk factors.

There is a need to address the problem of water main failure risk using a technique, such as fuzzy logic, that considers the uncertainty usually associated with risk factors.

#### 5.5.2.4 Fuzzy Expert Systems

Usually, systems that can process knowledge are called knowledge-based systems. One of the most popular and successful knowledge-based systems is the expert system (Jin, 2003). Fuzzy logic can be used as a tool to deal with imprecision and qualitative aspects that are associated with problem solving and in development of expert systems. Fuzzy expert system uses the knowledge of humans which is qualitative and inexact. In

many cases, decisions are to be taken even if the experts may be only partially knowledgeable about the problem domain, or data may not be fully available. The reasons behind using fuzzy logic in expert systems may be summarized as follows (Karray and de Silva, 2004): (1) the knowledge base of expert systems summarizes the human experts' knowledge and experience; (2) fuzzy descriptors (e.g., large, small, fast, poor, fine) are commonly used in the communication of experts' knowledge which is often inexact and qualitative; (3) problem description of the user may not be exact; (4) reasonable decisions are to be taken even if the experts' knowledge base may not be complete; and (5) educated guesses need to be made in some situations.

### 5.5.2.5 Risk Modeling

There are two types of risk assessment approaches – either quantitative or qualitative.

There are two types of risk assessment approaches – either quantitative or qualitative. In a quantitative approach, the quantification of the probability and severity of a particular hazardous event can be assessed and the risk is calculated as the product:  $\text{risk} = \text{probability} \times \text{severity}$ . The quantitative risk assessment approach includes many methods, such as Bayesian inference, fault tree analysis, Monte Carlo analysis, and fuzzy arithmetic as a semi-quantitative method. In a qualitative approach, the probability of an event may not be known, or not agreed upon, or even not recognized as hazardous. Qualitative risk assessment includes many methods, such as Preliminary Risk/Hazard analysis (PHA), Failure Mode and Effects analysis (FMEA), Fuzzy Theory, etc. (Kirchhoff and Doberstein, 2006; Lee M. , 2006). Generally, there are three types of risk models. They are matrix, probabilistic, and indexing models as discussed in the following sections (Muhlbauer, 2004).

#### 5.5.2.5.1 Matrix models

The matrix model ranks pipeline risks according to the likelihood and the potential consequences of an event by a simple scale.

Matrix models are one of the simplest risk assessment structures. This model ranks pipeline risks according to the likelihood and the potential consequences of an event by a very simple scale or a numerical scale (low to high or 1 to 5). Expert opinion or a more complicated application might be used in this approach to rank risks associated with pipelines (Muhlbauer, 2004).

#### 5.5.2.5.2 Probabilistic models

Probabilistic risk assessment (PRA), sometimes called Quantitative Risk Assessment (QRS) or Numerical Risk Assessment (NRA), is the most complex and rigorous risk model. It is a rigorous mathematical and

statistical technique that relies heavily on historical failure data and event-tree/fault-tree analysis. This technique is very data intensive. The result of the model is the absolute risk assessments of all possible failure events (Muhlbauer, 2004).

Probabilistic risk assessment is the most complex and rigorous risk model.

#### 5.5.2.5.3 Indexing models

Indexing models and similar scoring models are the most popular risk assessment techniques. In this technique, scores are assigned to important conditions and activities on the pipeline system that contribute to the risk, and weightings are assigned to each risk variable. The relative weight reflects the importance of the item in the risk assessment and is based on statistics when available or on engineering judgment (Muhlbauer, 2004).

Indexing models and similar scoring models are the most popular risk assessment techniques.

### 5.5.3 Research Methodology

The research methodology consists of many stages as shown in Figure 5-49. It starts with a full literature review of the risk of water main failure followed by data collection (to build the model and apply case study). A hierarchical fuzzy expert system (HFES) is developed using model information data. The next part of the research methodology is to develop a risk scale of failure which will guide the network operators to best manage their networks. The HFES model is used to assess the case study data collected from municipality.

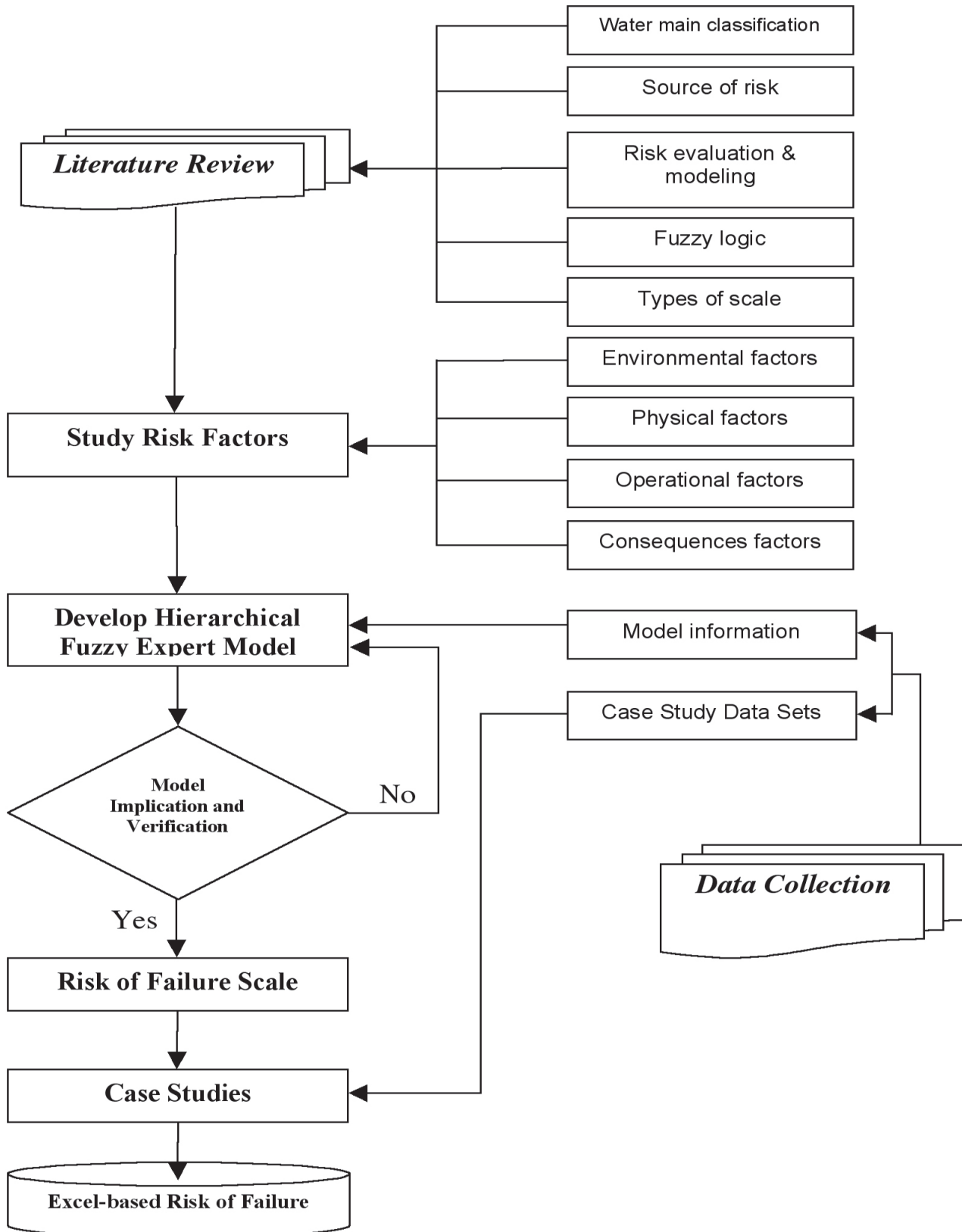

Figure 5-49: Research Methodology

### 5.5.4 Risk Factors Incorporated In The Current Research

Based upon literature and expert opinions, the risk of failure factors are identified and selected. Sixteen factors are incorporated in this research, which represents the deterioration and post-failure factors. The deterioration factors chosen to be incorporated in this research are selected based on the ease of gaining the required attributes of the water main by the facility managers. These attributes can be gathered from different types of documents such as: design information, visual inspection reports, maintenance reports, etc. The factors of cost of failure (consequence) are difficult to quantify and thus a qualitative approach will be followed. The factors selected to be incorporated in the pipeline failure risk model are clustered into four main categories and their factors as shown in Figure 5-50. The four main categories include: environmental, physical, operational, and post failure. Each category includes several factors as shown in Figure 5-50.

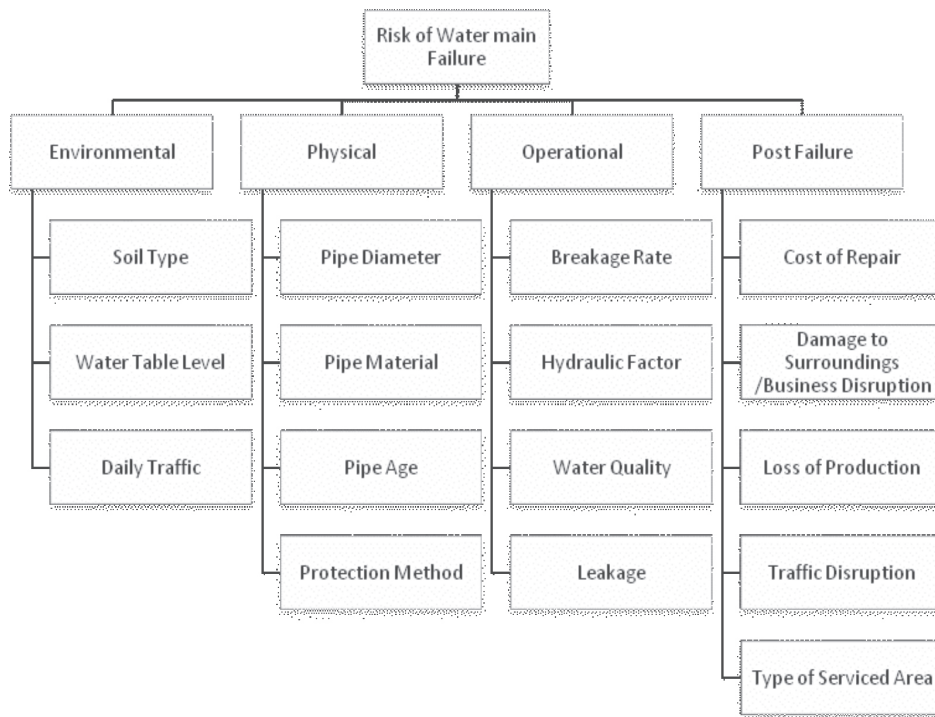

Figure 5-50: Hierarchical risk factors of water main failure

### 5.5.5. Data Collection

The data collection consists of two stages which are required to develop and run the fuzzy expert system. In stage one, the information needed for model building. In stage two, real network characteristics are gathered and analyzed to prove the concept of the developed model. The process of data collection is shown in Figure 5-51.

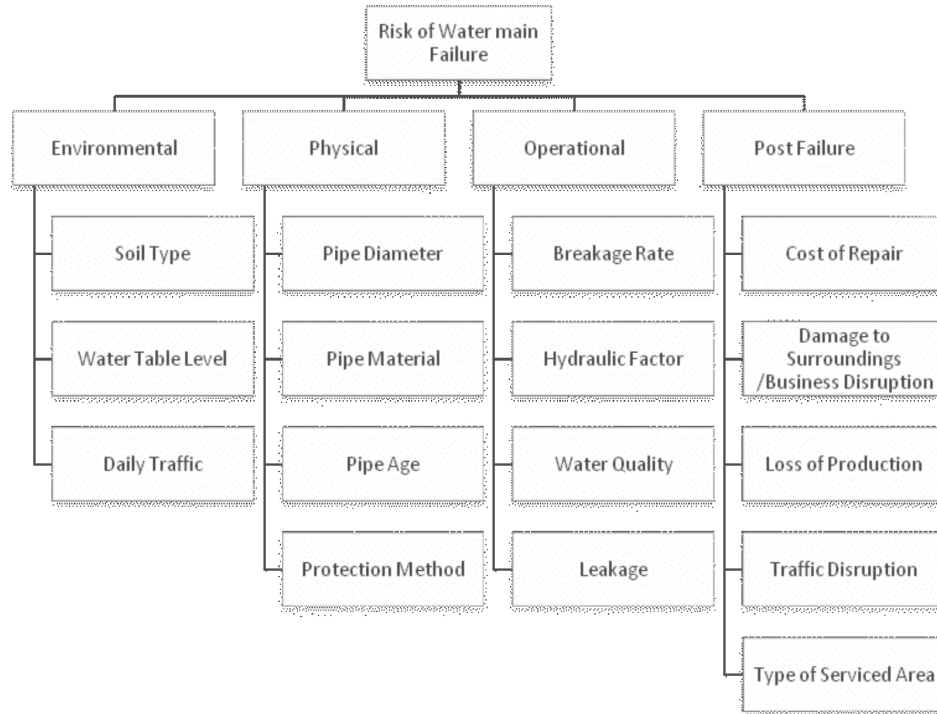

Figure 5-51: Water main data collection process

The information needed to develop the model consists of two parts: weights and performance impact of factors. The majority of information is gathered from the literature. The information that cannot be collected from the literature is collected via a questionnaire. The questionnaire was sent to fifty-eight experts (designers, operators, consultants, researchers), and feedback was received from only twenty, giving an average response of 34%. Geographically, the received responses can be summarized according to their locations as follows: Quebec 4 responses, Alberta 6, Ontario 6, British Colombia 2, New Brunswick 1, and Saskatchewan 1 response.

The relative weight of each factor at each level of the hierarchy (Figure 5-52) is collected. This could be the answer to the question of “What is the strength of the factor in contributing to the failure event?” This information is collected through a questionnaire. Figure 5-52 shows the normalized global weights of the risk of failure factors. It is obvious that pipe age has the highest weight and thus it has the most effect on the model. It is clear that pipe age has the highest effect among the other factors, followed by pipe material and breakage rate.

The performance assessment of the different factors (Figure 5-52) is collected mainly from the literature. Missing information is collected via questionnaires. This information is collected in the form of (if-then) or (cause-effect) where the answer is standardized to the following list of points: “*Extremely High, Very High, Moderately High, Medium, Moderately Low, Very Low, Extremely Low.*”

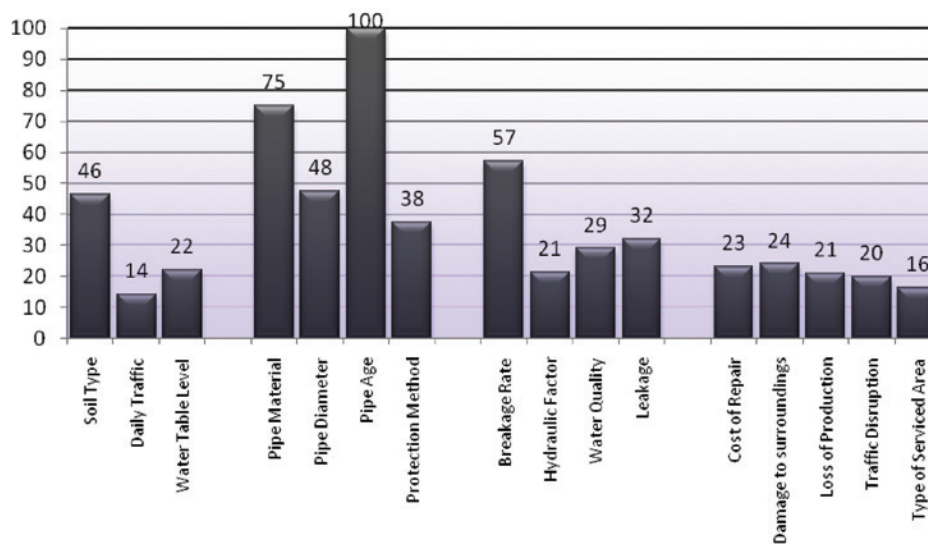

Figure 5-52: Risk factors normalized global weights

### 5.5.5.1 City of Moncton, New Brunswick, Canada, Case Study

The data of this case study is collected from the City of Moncton, New Brunswick, Canada. The City of Moncton operates a water supply and distribution system which provides water to 95% of its population. The approximate length of the water main is 448 km. It serves more than 58,000 people. Cast iron water mains account for about 39% of all the water main, followed by ductile iron with 31%. PVC water mains account for 19%. Asbestos cement (3%) accounts for a much smaller part of the system (Dillon Consulting and Harfan Technologies, 2003).

The factors included in the Moncton dataset are: pipe material, pipe diameter, installation year, protection method, number of breakage, Hazen-William factor, and loss of production (pipe diameter). The number of records in this data set is only 544. The actual data is much larger; however, these 544 records are the only records that have complete information, such as breakage rate, Hazen-William coefficient ...etc). The percentages of the pipe material used in the Moncton system is shown in Figure 5-53, which shows that the most used pipe material is Post War Cast Iron (built after World War II).

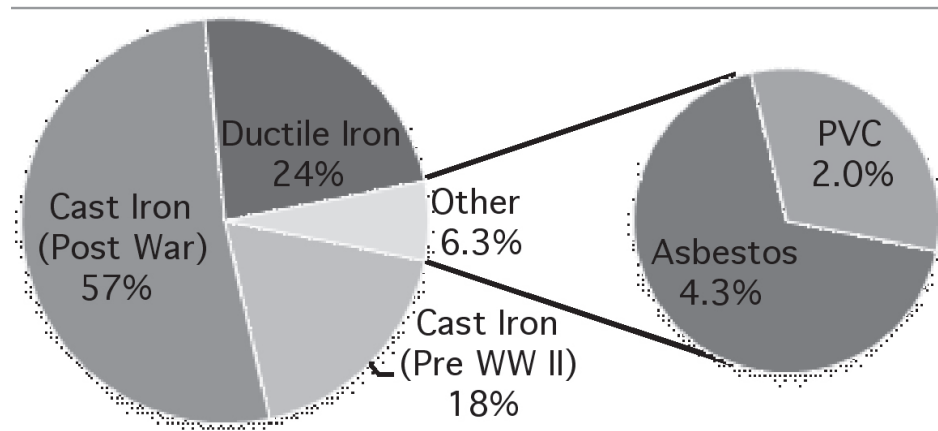

Figure 5-53: Percentage of pipe materials used in Moncton

### 5.5.6 Hierarchal Fuzzy Expert System For Water Main Risk Of Failure

The hierarchical fuzzy model structure consists of four sub-models (branches), which correspond to the four main categories and another model that combines the results of the four branches of the hierarchy to produce risk of failure. The crisp defuzzified results of the four models (environmental, physical, operational, and post-failure) are combined together through a risk of failure model which calculates the risk of failure index of a water main. The fuzzy structure of each of the five models is identical and only the membership functions of categories and their factors and the knowledge base rules of each model are different. The full view of the hierarchical fuzzy model is shown in Figure 5-54, which shows the processing of the observed characteristics of the water main network. The use of a hierarchical system is a key to reducing the total number of required expert rules. In this model, if a hierarchical fuzzy system is not used, then the total number of rules required to cover all of the possible factor performance combinations is calculated by the simple multiplication of the number of performances (membership functions) of each of the sixteen factors.



### 5.5.6.1 Determining Membership Functions of Various Factors

The membership functions of the different factors are built based on the information gathered from the literature, such as the characteristics of each factor, and the effects of these characteristics on the risk of failure. The qualitative factors are evaluated on a 0-10 scale and assigned a standard five membership functions. In this paper, only derivation and representation of the membership functions of the most important factor of each category (branch) is presented. In environmental category (branch), soil type is the most important factor in this group. Specific types of soil can lead to biochemical, electrochemical, and physical reactions, which can degrade the pipe material and make it vulnerable to structural degradation. This step results in deteriorating the pipe material and causing the material to lose its ability to resist the forces of the surrounding soil (Hahn et al., 2002). Soil is typically classified by grain size according to the Unified Soil Classification System as coarse grained and fine grained, which in their turn are classified as Gravel, Sand, Clay and Silt with liquid limit  $> 50$  and Clay and Silt with liquid limit  $< 50$ .

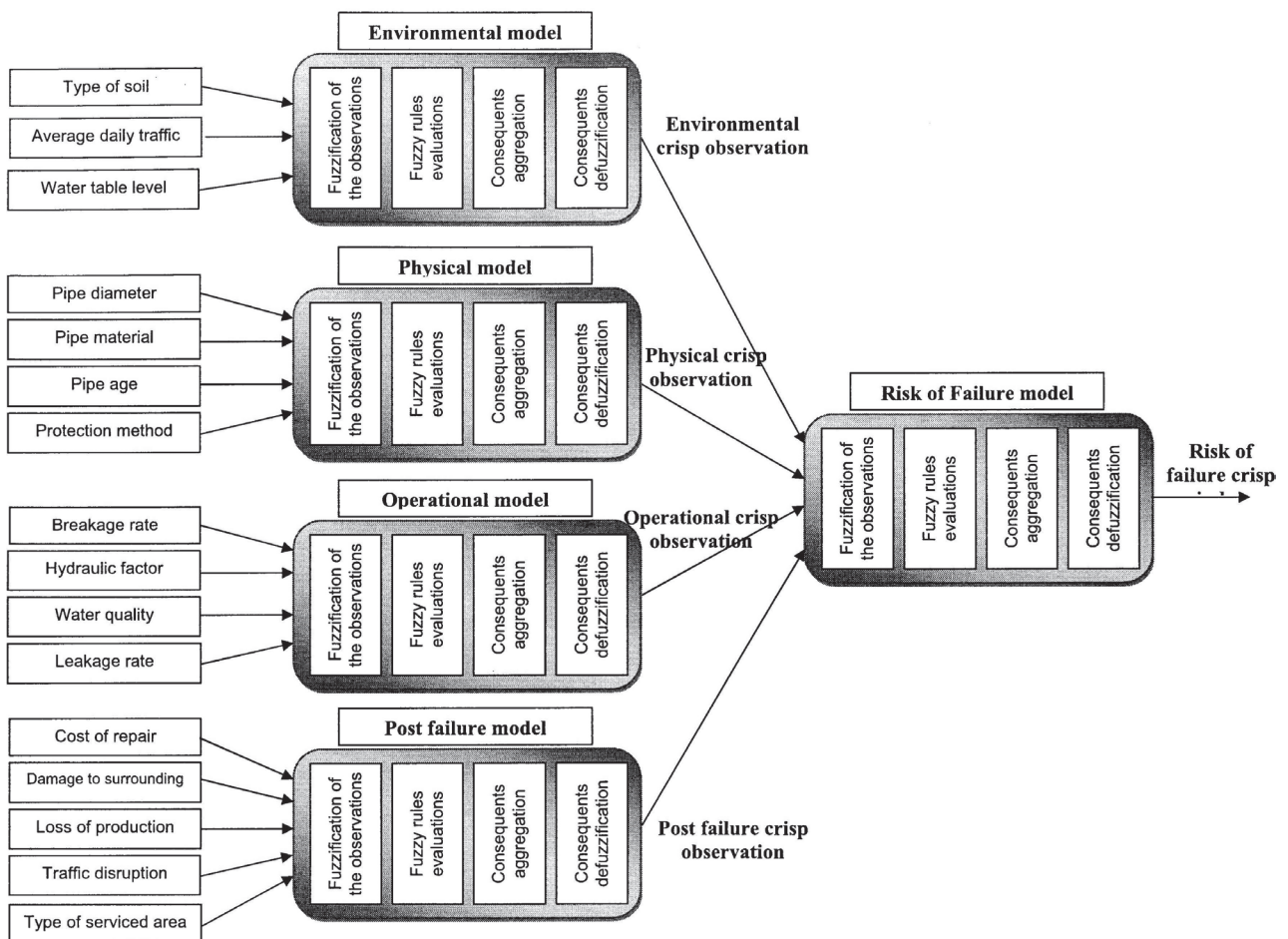

Figure 5-54: Full view of the model components

However, the most important soil characteristic for water mains is the presence of chemicals that deteriorate pipeline material and the interaction between the soil and the pipe material. Thus, soil is classified according to potential corrosiveness as highly corrosive, moderately corrosive, and low corrosive (Al Barqawi, 2006).

Soil uniformity is also considered an important factor. When the pipe is in contact with dissimilar soil types, localized corrosion cells can be developed which contribute to metallic pipe material corrosion. Moreover, soil pH is considered a good indicator of external corrosion because corrosion occurs in a certain range of pH (Najafi, 2005). There are many soil characteristics that play a role in the deterioration process and thus make studying their effects complex and beyond the scope of this research. Therefore, for this research, the soil is classified into five subjective groups according to the strength of deterioration action as very highly, highly, moderately, lightly, and very lightly deteriorative. The membership functions and their characteristics are shown in Figure 5-55A.

The data type to be used for this factor is numerical from 0 to 10 where 0 and 10 indicate the least and highest deteriorative soil conditions, respectively.

In the physical category (branch), according to Al Barqawi (2006), pipe size is one of the most important factors that contribute to the pipeline failure. In his investigation of risk factors in urban pipeline failure, Raven (2007) classified pipeline diameter into three groups: group 1 (4 in. to 8 in.), group 2 (10 in. to 30 in.), and group 3 (36 in. to 72 in.). Ozger (2003) developed a regression model to estimate water main breakage rate in which one of his findings is that the breakage rate of pipelines decreases as the pipe diameter increases. This is because larger diameter pipes have more beam strength than smaller diameter pipes (Najafi, 2005). In light of the above review, the pipe diameter factor is classified into 2 groups as small (less than 250 mm) and medium (250 mm to 500 mm). The large diameter pipelines (greater than 500 mm) are not considered here, since they are used in transmission water mains, which are beyond the scope of this research. The membership functions and their characteristics are shown in Figure 5-55B. The data type used for this factor is pipeline diameter up to 500 mm.

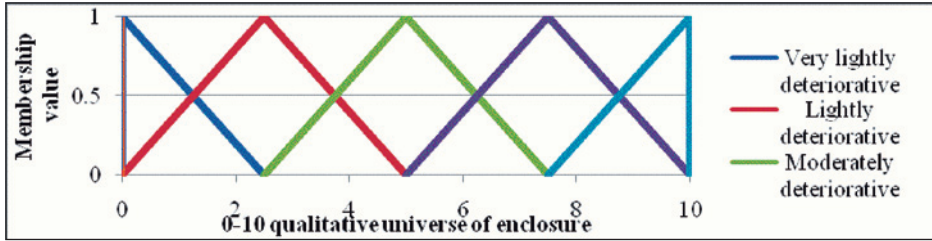

**A** Soil type membership functions.

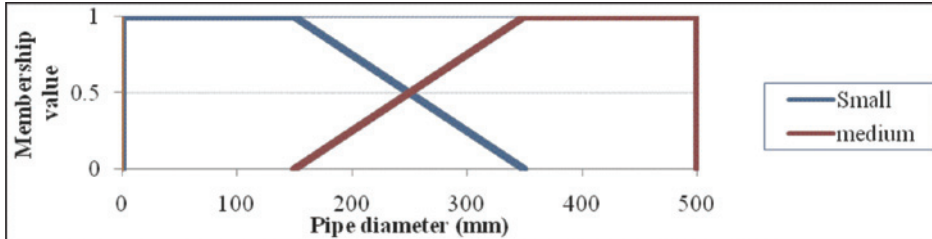

**B** Pipe diameter membership functions.

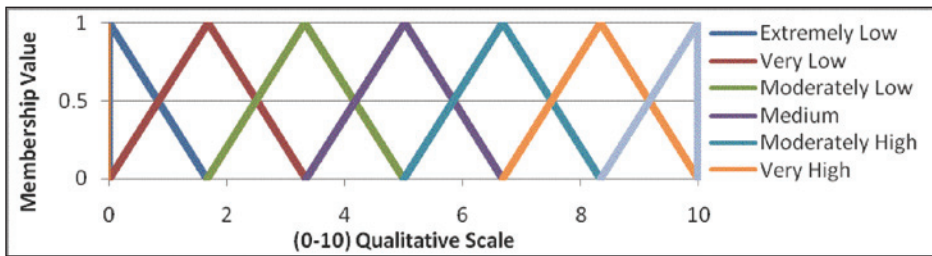

**C** Breakage rate membership functions.

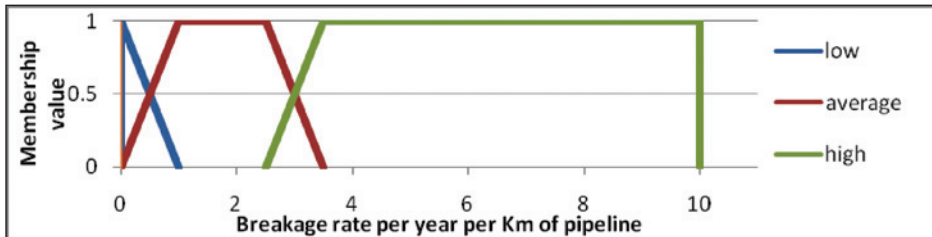

**D** Damage to surrounding membership functions.

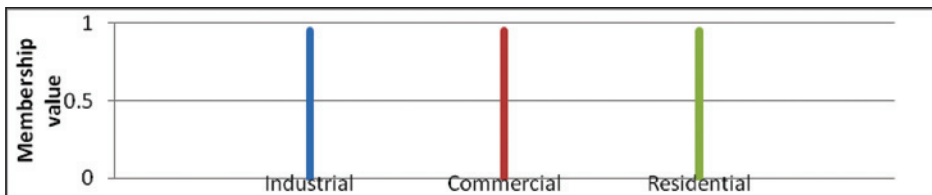

**E** Consequent membership functions.

Figure 5-55: Sample membership functions for various factors

In operational category (branch), breakage rate is considered the most important factor that gives indication about the risk of failure of water mains. From closely studying the results and findings of Al Barqawi (2006), the breakage rate as a risk factor can be classified into three ranges: low (0 to 0.5), average (0.5 to 3), and high (> 3). According to the analysis of Al Barqawi (2006), the breakage rate factor changes its behavior at values of 0.5 and 3 breaks/km/yr. The membership functions and their characteristics are shown in Figure 5-55C. The data type used for this factor is the number of water main breaks per one kilometer per year with a maximum of 10 breaks/km/yr.

In post failure category (branch), the most important factor is damage to surroundings/ Business Disruption. The most visible impact associated with a water main break is the occurrence of flooding affecting structures. Flooding causes quantifiable damage to structures and their contents, which is dependent on the type, value, regional location and use of a specific structure. The cost associated with flooding includes damage to building structure and content as well as surrounding properties, such as gardens and sheds (Cromwell et al., 2002). In this research, the damage to surroundings and business disruption is classified into three groups according to the location of the pipeline failure, such as residential, commercial, and industrial. The membership functions and their characteristics are shown in Figure 5-55D. The data type to be used for this factor is linguistic for the three main types: Industrial, Commercial, and Residential.

### 5.5.6.2 Fuzzy Inference

In this research, the indirect knowledge acquisition method is used to develop the knowledge base of the risk of water main failure model.

In this research, the indirect knowledge acquisition method (using questionnaires and literature) is used to develop the knowledge base of the risk of water main failure model. The Mamdani fuzzy rules system type is used in the fuzzy model, which has an advantage over the Takagi-Sugeno-Kang (TSK) method of being easier to understand and the consequents of the system are defined in terms

of fuzzy sets. The Mamdani method is based on a simple structure of Min operations as shown in Equation (1) (Jin, 2003):

 Equation

$$R^j: \text{If } x_1 \text{ is } A_1^j \text{ and } x_2 \text{ is } A_2^j \text{ and } x_3 \text{ is } A_3^j \text{ and } \dots x_n \text{ is } A_n^j \text{ THEN } y \text{ is } B^j \quad (1)$$

Where  $R^j$  is the  $j$ -th rule,  $A_j^i$  ( $j = 1, 2, \dots, N, i = 1, 2, \dots, n$ ),  $B^j$  are the fuzzy subsets of the inputs and outputs respectively. This rule can be written mathematically as Equation (2) (Jin, 2003):

$$\mu_{R^j}(x_1, x_2, x_3, \dots, x_n, y) = \mu_{A_1^j} \wedge \mu_{A_2^j} \wedge \mu_{A_3^j} \dots \wedge \mu_{A_n^j} \wedge \mu_{B^j} \quad (2)$$



Where  $\wedge$  denotes the minimum operator.

Since the factors' performance is collected from the literature or via a questionnaire independently of each other, a new methodology is proposed to combine the different factors' performance to generate fuzzy rules as represented in equation (1). This methodology outline is shown in Figure 5-56. Examples of the fuzzy rules as presented in the environmental branch (model) are shown in Table 5-14. The knowledge base fuzzy rules should cover all of the possible combinations of the factors' performance linguistic variables (membership functions).

In this research, the consequent linguistic variable  $B$  is standardized on a list of seven linguistic variables as shown in Figure 5-55E: Extremely low, Very low, Moderately Low, Medium, Moderately High, Very High, and Extremely High. This is applicable to each of the five developed models (environmental, physical, operational, post failure, and risk of failure).

### 5.5.6.3 Consequent Aggregation

After evaluating each rule in the knowledge base, the membership value of each consequent membership function (output linguistic variable) is aggregated using a maximum operation as shown in Equation (3). In other words, the maximum membership value of any consequent membership function (shown in Figure 5-55E) is used to truncate that consequent membership function for later use in the defuzzification of the fuzzy output.

$$\mu_R(x_1, x_2, x_3, \dots, x_n, y) = \bigvee_{j=1}^N [\mu_{R^j}(x_1, x_2, x_3, \dots, x_n, y)] \quad (3)$$



Where  $\bigvee$  denotes the maximum operation,  $R$  represents each of the consequent membership functions as standardized to the list of (Extremely low, Very low, Moderately Low, Medium, Moderately High, Very High, and Extremely High). This is also applicable to each model of the five developed models (environmental, physical, operational, post failure, and risk of failure).

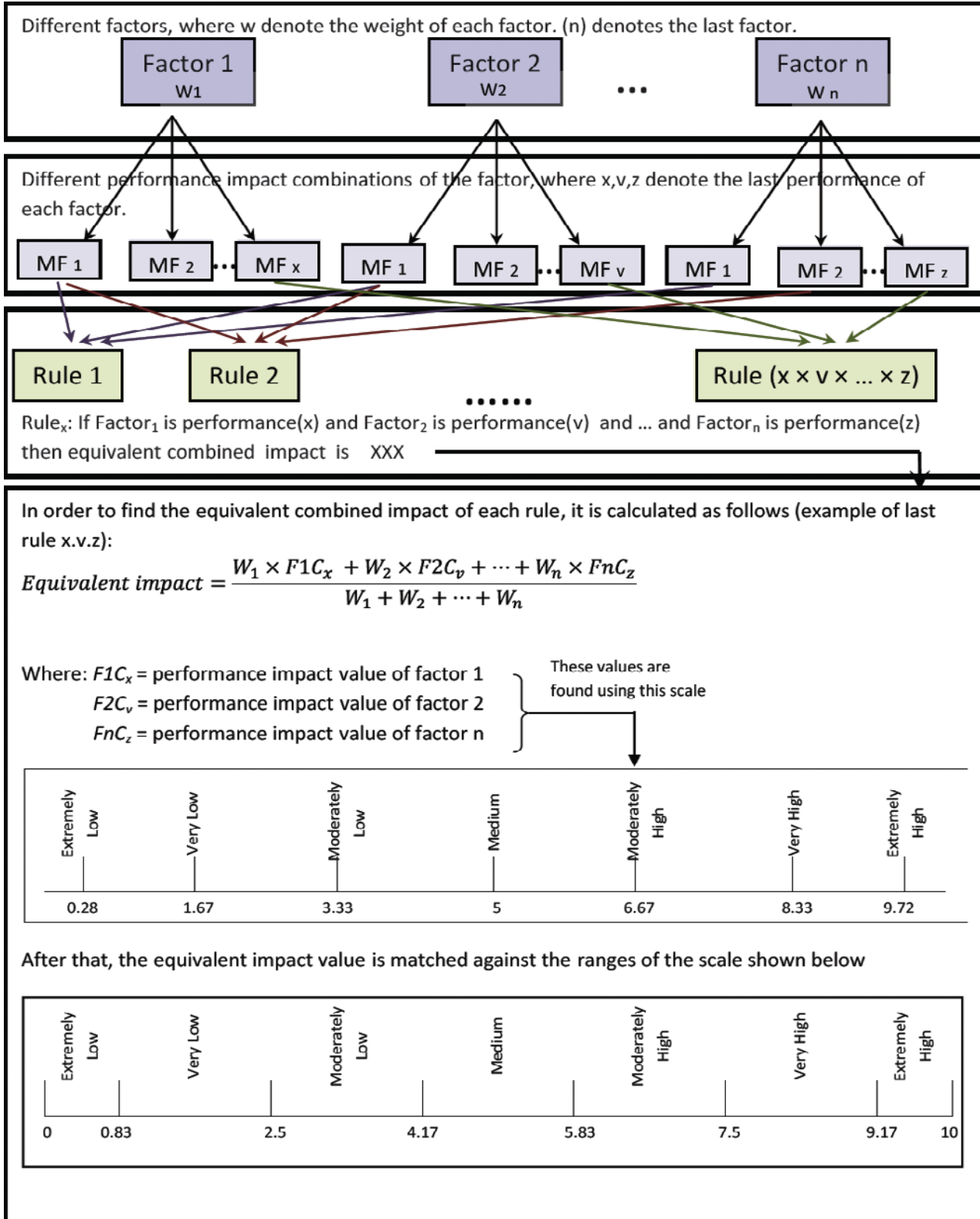

Figure 5-56: Proposed methodology for fuzzy rules extraction

Table 5-14: Sample environmental factors performance combined impact

Rule No.	Factors' performance combinations			Combined Impact
	Soil	Traffic	Water Table	Environmental risk
1	Very highly deteriorative	Very heavy	always present	Very High
2	Very highly deteriorative	Very heavy	seasonally present	Extremely High
3	Very highly deteriorative	Very heavy	rarely present	Moderately High
4	Very highly deteriorative	Heavy	always present	Very High
5	Very highly deteriorative	Heavy	seasonally present	Extremely High
:	:	:	:	:
:	:	:	:	:
73	Very lightly deteriorative	Very light	always present	Very Low
74	Very lightly deteriorative	Very light	seasonally present	Moderately Low
75	Very lightly deteriorative	Very light	rarely present	Extremely Low

#### 5.5.6.4 Defuzzification Process

There are many defuzzification methods that convert the fuzzy consequents into crisp values. The method used in this research is the Center of Sum as shown in Equation (4). This equation calculates the center of gravity of each truncated consequent membership function found from the previous step (neglecting the union operation) and then average-weights them by their areas. It has the advantage of being simple to program, requiring less computer resources, and giving reasonable results. This is also applicable to each model of the five developed models (environmental, physical, operational, post failure, and risk of failure).

*Crisp Risk Output =*

$$= \sum_{n=\text{extremely low}}^{\text{extremely high}} \text{Truncated Area}_n \times \text{Centroid}_n / \sum_{n=\text{extremely low}}^{\text{extremely high}} \text{Truncated Area}_n \quad (4)$$



#### 5.5.6.5 Proposed Risk of Failure Scale

In light of the literature review, a risk of failure scale is proposed to help the decision makers in water main management of companies/municipalities make an informed decision. The scale ranges numerically from 0 to 10, where 10 indicates the riskiest condition of the pipeline and 0 indicates the least risky condition and shown in Figure 5-57. Linguistically,

the scale is divided into five groups or regions that describe the risk of pipeline failure and the required corrective actions to be taken if needed. The number of proposed groups and their ranges and associated corrective actions may be changed to best suit a municipality's strategies and their risk tolerance.

Figure 5-57:  
Proposed risk of failure scale

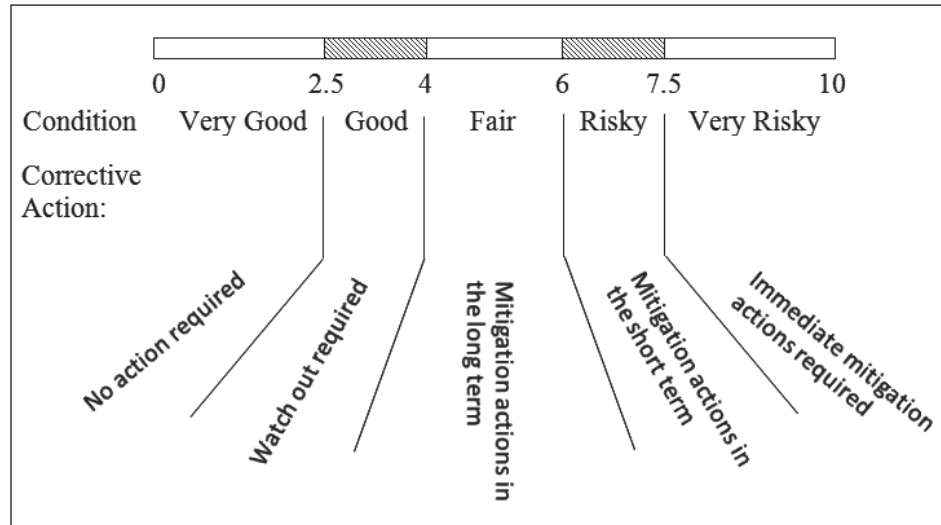

### 5.5.7 The Developed HFES Application to Case Study, City of Moncton, New Brunswick, Canada

The data of this case study is collected from City of Moncton, New Brunswick, Canada. The factors included in this database are; pipe material, pipe diameter, installation year, number of breaks, hazen-william factor, and loss of production. The number of records in this data set is only 544 records due to the fact that not all records have information about their current status (breakage rate, Hazen-William coefficient, etc).

#### 5.5.7.1 Case Study Analysis

The collected data set is processed using HFES model and the proposed scale. Tables 5-15 and 5-16 summarize the results of the data set assessment using the proposed HFES model and the characteristics of the selected pipes for rehabilitation. It can be deduced that Cast Iron and Small Diameter pipes (< 250 mm) contribute most to network risk. In overall, the condition of the network is fair (66% of the network) with some parts of the network require mitigation action in the short-term plan.



Table 5-15: Case Study Results Summary

Linguistic Group	Proposed Action	No. of WM seg	Length, <i>m</i>
Very Good	No action required	15	4,503
Good	Watch out	93	34,462
Fair	Mitigation action in long-term plan	373	101,248
Risky	Mitigation action in short-term plan	63	12,831
Very Risky	Immediate mitigation action required	0	0
Total :		544	153,044

Table 5-16: Case Study Pipes Evaluation And Rehabilitation Plan Statistics of Fair and Risky Status

Pipe Characteristics		Case study pipes evaluation statistics				Rehabilitation plan statistics			
		Fair		Risky		Fair		Risky	
		Count	Length <i>m</i>	Count	Length <i>m</i>	Count	Length <i>m</i>	Count	Length <i>m</i>
Dia	Small	314	73,053	65	12,751	37	6,996	46	9,836
	Medium	57	28,196	1	80	17	6,252	0	0
Material	Cast Iron	56	17,057	49	10,337	28	8,567	31	7,639
	Cast Iron Post War	282	73,157	17	2,494	23	4,075	15	2,197
	Asbestos	18	6,578	0	0	2	314	0	0
	Ductile Iron	15	4,457	0	0	1	292	0	0

Figure 5-58 illustrates a framework on how the decision can be taken regarding water main management using the proposed model.

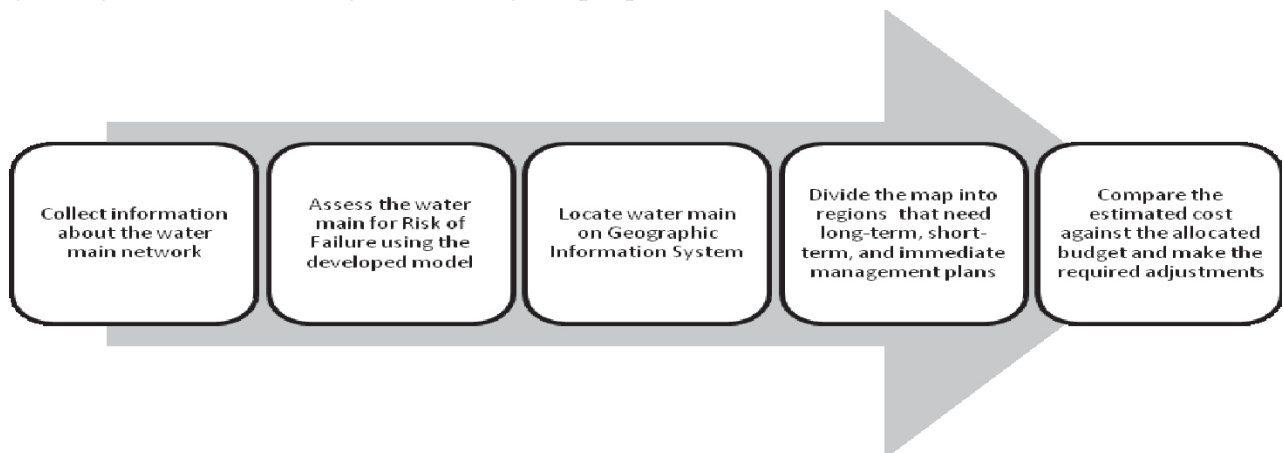
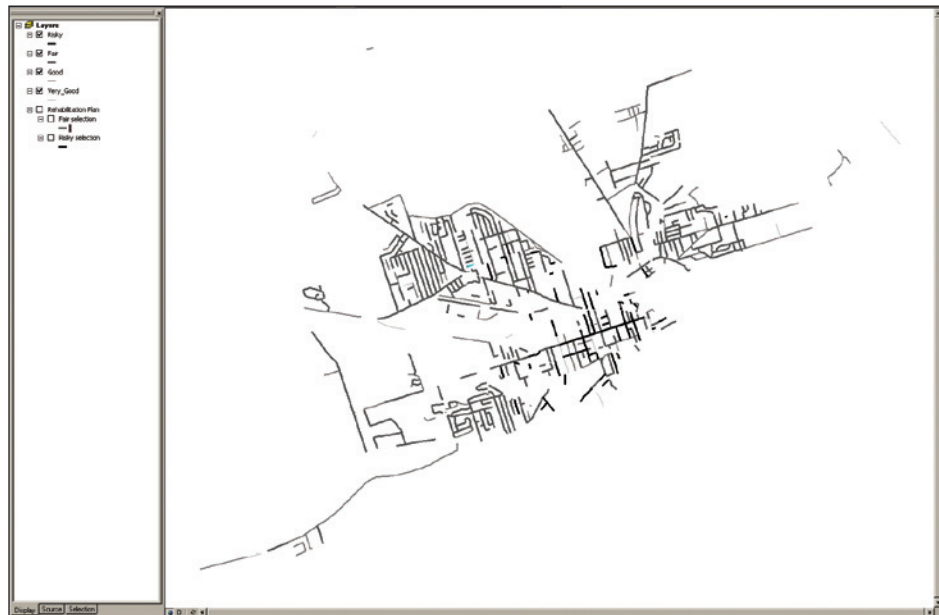

Figure 5-58: Decision-making flow chart.

The results can be further analyzed using the GIS system which provides the opportunity to locate the different pipes and ease the setup of a management plan. The pipes that are assessed using the proposed model are shown in Figure 5-59. The pipes are colored and grouped according to their risk of failure score. The groups are the same proposed in the risk of failure scale: Very Good, Good, Fair, Risky, and Very Risky. After reviewing the pipelines' locations, the management team may decide to renew or rehabilitate the risky pipelines. However, due to the fact that the risky pipelines are located in an almost enclosed area, the management team may decide to include the pipelines at fair risk (which will need mitigation actions in the long-term plan) in the rehabilitation plan to save on the costs of mobilization and equipment transportation. The management team may include only the pipes at fair risk that are top ranked or may not include any fair risk pipes according to the allocated budget. Figure 5-59 shows a proposed area to be included in a rehabilitation plan which includes both risky and fair pipes. The short-term rehabilitation plan can be set for every year or any other period of time depending on a management team's preference. It should be noted that not all the risky pipes are included in the plan since some are remote from the proposed area and they will require a considerable amount of money to rehabilitate them to account for the cost of mobilization and transportation, and thus the management team may be willing to carry the risk of failure by doing nothing to these pipes.

**Figure 5-59:**  
Proposed rehabilitation area  
(Risky and Fair pipelines)



### 5.5.8 Conclusions

The current research solves the challenge faced by municipalities and other authorities on prioritizing the rehabilitation works of their distribution water main. It offers a model to evaluate the risk of water main failure. The model considers many risk factors which can be divided broadly into deterioration factors that lead to the failure event and consequences factors that are resulted from the failure event (failure impact). Sixteen risk of failure factors are incorporated in the model (11 deterioration factors and 5 consequence factors). To build this model, hierarchical fuzzy expert system is used which considers the uncertainty in the water main attributes. The model is validated using AHP deterioration model. AHP model outputs are compared with the proposed model output and found that the proposed fuzzy expert model is valid. From the developed model, it can be deduced that pipe age has the highest effect on risk of water main failure among the other factors then come pipe material and breakage rate. Municipal water main managers, consultants, and contractors can use the developed application to assess the risk of water main failure and to plan their rehabilitation works accordingly. The application, however, gives a high level of flexibility to adapt to the management preferences and altitudes of each authority.

Future works of this research can consider third level of the hierarchy to consider even sub-sub-factors which will allow the sub-factors to be quantified instead of qualified which will give better, certain results. Moreover, the use of GIS should be incorporated in the research as the rehabilitation works also consider grouping of the water main in the same area leading to a more efficient use of the allocated budget.

### 5.5.9 References

- Al Barqawi, H. 2006. *Condition Rating Models for Underground Infrastructure: Sustainable Water-Mains*. MS. Thesis, Concordia University, Montreal, QC, Canada.
- Bandyopadhyay, T., Dey, P., and Gupta, S. 1997. A cost-effective maintenance program through risk analysis. *AACE International Transactions*, AACE, Dallas, TX, USA, 84-89.
- Bhave, P. 2003. *Optimal Design of Water Distribution Networks*. Alpha Science Int'l Ltd., Oxford, UK.
- Christodoulou, S., Aslani, P., and Vanrenterghem, A. 2003. Risk Analysis Framework for Evaluating Structural Degradation of Water Mains in Urban Settings Using Neurofuzzy Systems and Statistical Modeling Techniques. *World Water and Environmental Resources Congress*, ASCE, Philadelphia, PA, USA, 1-9.

- Ezell, B., Farr, J., and Wiese, I. 2000. Infrastructure Risk Analysis Model. *Journal of Infrastructure Systems*, 6: 114-117.
- Gentile, M. 2004. *Development of a Hierarchical Fuzzy Model for the Evaluation of Inherent Safety*. PhD Dissertation, Texas A&M University, Texas, USA.
- Giustolisi, O., Laucelli, D., and Savic, D. 2006. Development of rehabilitation plans for water mains replacement considering risk and cost-benefit assessment. *Civil Engineering and Environmental Systems*, 23: 175-190.
- Hahn, M., Palmer, R., and Merr, M. S. 2002. Expert System for Prioritizing the Inspection of Sewers: Knowledge Base Formulation and Evaluation. *Journal of Water Resources Planning and Management*, 128: 121-129.
- InfraGuide, N. G. 2006. Managing Risk. Decision Making and Investment Planning, <[http://www.infraguide.ca/bestPractices/PublishedBP\\_e.asp#dmip](http://www.infraguide.ca/bestPractices/PublishedBP_e.asp#dmip)> (Jan. 17, 2007).
- Infrastructure Report, 2007. The Water Main Break Clock, Canada Free Press, <<http://www.canadafreepress.com/infrastructure.htm>> (Jan. 23, 2008).
- Jin, Y. 2003. *Advanced Fuzzy Systems Design and Applications*. A Springer-Verlag Company, New York, USA.
- Karray, F., and de Silva, C. 2004. *Soft Computing and Intelligent Systems Design*. Pearson Education Limited Essex, England.
- Kirchhoff, D., and Doberstein, B. 2006. Pipeline risk assessment and risk acceptance criteria in the State of São Paulo, Brazil. *Impact Assessment and Project Appraisal*, 24: 221-234.
- Kleiner, Y., and Rajani, B. 2000. Considering Time-dependent Factors in the Statistical Prediction of Water Main Breaks. *AWWA Infrastructure Conference*, Baltimore, MD, USA. 1-12.
- Kleiner, Y., and Rajani, B. 2002. Forecasting Variations and Trends in Water-Main Breaks. *Journal of Infrastructure Systems*, 8: 122-131.
- Kleiner, Y., Sadiq, R., and Rajani, B. 2004. Modeling Failure Risk in Buried Pipes Using Fuzzy Markov Deterioration Process. *Pipeline Engineering and Construction: What's on the Horizon?*, ASCE, San Diego, CA, USA, 1-12.
- Kleiner, Y., Rajani, B., and Sadiq, R. 2006. Failure risk management of buried infrastructure using fuzzy-based techniques. *Journal of Water Supply Research and Technology: Aqua*, 55: 81-94.
- Lee, M., Chung, H., and Yu, F. 2003. Modeling of hierarchical fuzzy systems. *Fuzzy Sets and Systems*, 138: 343-361.
- Marshall, D., Zarghamee, M., Mergalas, B., and Kleiner, Y. 2005. Tarrant Regional Water District's Risk Management Plan for Prestressed Concrete

Cylinder Pipe. *The Pipeline Division Specialty Conference*, ASCE, Houston, TX, USA, 854-861.

Moglia, M., Burn, S., and Meddings, S. 2006. Decision support system for water pipeline renewal prioritisation. *ITcon*, 11, 237-256.

Muhlbauer, W. K. 2004. *Pipeline Risk Management Manual*, 3rd ed., Gulf Professional Publishing, Burlington, Ontario, Canada.

Nikolaidis, E., Ghiocel, D., and Singha, S. 2005. *Engineering design reliability handbook*, CRC Press, Florida, USA.

Ozger, S. 2003. A semi-pressure-driven approach to reliability assessment of water distribution networks. PhD Dissertation, Arizona State University, Arizona, USA.

Pelletier, G., Mailhot, A., and Villeneuve, J. 2003. Modeling Water Pipe Breaks-Three Case Studies. *Journal of Water Resources Planning and Management* 10, 129: 115-123.

Rajani, B., Kleiner, Y., and Sadiq, R. 2006. Translation of pipe inspection results into condition ratings using the fuzzy synthetic evaluation technique. *Journal of Water Supply Research and Technology: Aqua*, 55: 11-24.

Rogers, P. 2006. *Failure Assessment Model to Prioritize Pipe Replacement in Water Utility Asset Management*. PhD Dissertation, Colorado State University, Colorado, USA.

Sadiq, R., Rajani, B., and Kleiner, Y. 2004. Probabilistic risk analysis of corrosion associated failures in cast iron water mains. *Reliability Engineering and System Safety*, 86: 1-10.

Selvakumar, A., Clark, R., and Sivaganesan, M. 2002. *Costs for Water Supply Distribution System Rehabilitation*. Environmental Protection Agency, New Jersey, USA.

Souza, R., and Chagas, P. 2001. Risk Analysis in Water Quality Problems. *World Water and Environmental Resources Congress*, ASCE, Orlando, FL, USA, 1-6.

Yan, J., and Vairavamoorthy, K. 2003. Fuzzy Approach for Pipeline Condition Assessment. *New Pipeline Technologies, Security, and Safety*, ASCE, Baltimore, MD, USA, 467-476.

Yuhua, D., and Datao, Y. 2005. Estimation of failure probability of oil and gas transmission pipelines by fuzzy fault tree analysis. *Journal of Loss Prevention in the Process Industries*, 18: 83-88.

Zayed, T. and Halpin, D. 2005. Pile Construction Productivity Assessment. *Journal of Construction Engineering and Management*, 131: 705-714.

## 5.6 Integrated Condition Assessment Model and Classification Protocols for Sewer Pipelines

*Fazal Chughtai<sup>12</sup> and Tarek Zayed<sup>13</sup>*

### 5.6.1 Introduction

**A**doption of a suitable sewer pipeline condition classification protocol is recognized as an indispensable first step in worldwide sewer rehabilitation industry. Various condition classification systems for sewers have been developed in this regard. These systems differ according to local requirements in which there is no integrated and unified sewer condition assessment protocol available. Therefore, there is an urgent need of developing standardized sewer condition assessment procedures.



This paper has the objectives of reviewing the historical development of different sewer condition classification protocols

and developing a combined condition index (CCI) for sewers, which integrates the combined effect of structural and operational conditions. In order to achieve these objectives, unsupervised neural network models have been developed. The CCI is divided into 5 condition categories, ranging from "Acceptable" to "Critical." Unsupervised, self-organizing, neural network approach is also used to develop the CCI. The opinion of municipal practitioners is utilized to verify the CCI and integrated protocol. The developed integrated models and protocols will assist municipal engineers in developing a unified sewer condition assessment system.

**INFRASTRUCTURE TYPE:** Sewer systems

Sewer condition classification protocols have become of paramount importance for the worldwide sewer rehabilitation industry in order to ascertain critical information regarding the underground infrastructure (Thornhill et al., 2005). The historical background of the development of these protocols escorts to 1977; when for the first time, sewer defect codes were developed in the UK. Based on these codes and local requirements, several condition classification protocols have been developed throughout the world during the past thirty years. It is difficult for a municipality to select amongst the available protocols, which generates a wide range of protocol applications within one city. Typically, these protocols can not converse to each other, which generate disconnection and barriers within the same city or across various cities within the state or province. Therefore, municipalities following any specific condition assessment protocols are not able to compare their sewer inspection data with other municipalities who have adapted other systems, resulting in lack of understanding, learning, and benchmarking in the field of sewer condition assessment. Therefore, there is an urgent need to

develop a unified condition assessment protocol for sewer management

<sup>12</sup> Cost Engineer, SNC Lavalin Inc. Edmonton, AB, Canada; Email: fazal.chughtai@snc-lavalin.com

<sup>13</sup> Associate Professor, Department of Building, Civil and Environmental Engineering, Concordia University, Montreal, PQ, Canada; Email: zayed@bcee.concordia.ca

(Rahman et al., 2004; Chughtai, 2007). Furthermore, currently no integrated database conversion system is available to convert sewer condition assessment observations taken as per any specific condition assessment protocol into other protocols.

Sewer condition assessment protocols usually depend on some weighted factors, which are used to grade the severity of a sewer's condition. These weighted factors focus on two types. The first type describes the physical (structural) condition of sewer pipelines and the second type depicts the capability of sewer pipelines to meet their service requirement (operational condition). As a result, each sewer pipe is assigned two different condition ratings, which therefore confuse the decision makers when prioritizing sewer rehabilitation needs.

Sewer condition assessment protocols usually depend on some weighted factors, which are used to grade the severity of a sewer's condition.

The presented research in this paper mainly focuses on developing a methodology for integrating sewer condition classification protocols into a single, i.e. standardized, sewer classification system. Therefore, the main objectives of this research are:

- Develop a unified (i.e. convertible) sewer condition assessment protocol.
- Design a combined condition index (CCI) through integrating structural and operational conditions of sewer pipelines; thus, helping decision makers in visualizing a complete picture of a sewer's condition

An unsupervised neural network methodology is adapted for integrating sewer condition assessment protocols and developing the combined condition index (CCI) of sewer pipelines. The protocols developed by the Water Research Centre (WRc), UK, and the Centre for Expertise and Research on Infrastructures in Urban Areas (CERIU), Canada, have been used for the modeling process.

## 5.6.2 Sewer Condition Classification Protocols

In 1977, sewer defect codes were developed, for the first time, by the Water Research Centre (WRc), UK. Figure 5-60 shows a historic overview of the development of different sewer condition classification protocols worldwide (Thornhill et al., 2005).

In Canada, the two main utilized protocols are WRc and CERIU in which this research will focus on. Many municipal agencies have adapted the

Figure 5-60:  
Historical Background of Sewer  
Condition Assessment Protocols  
Development

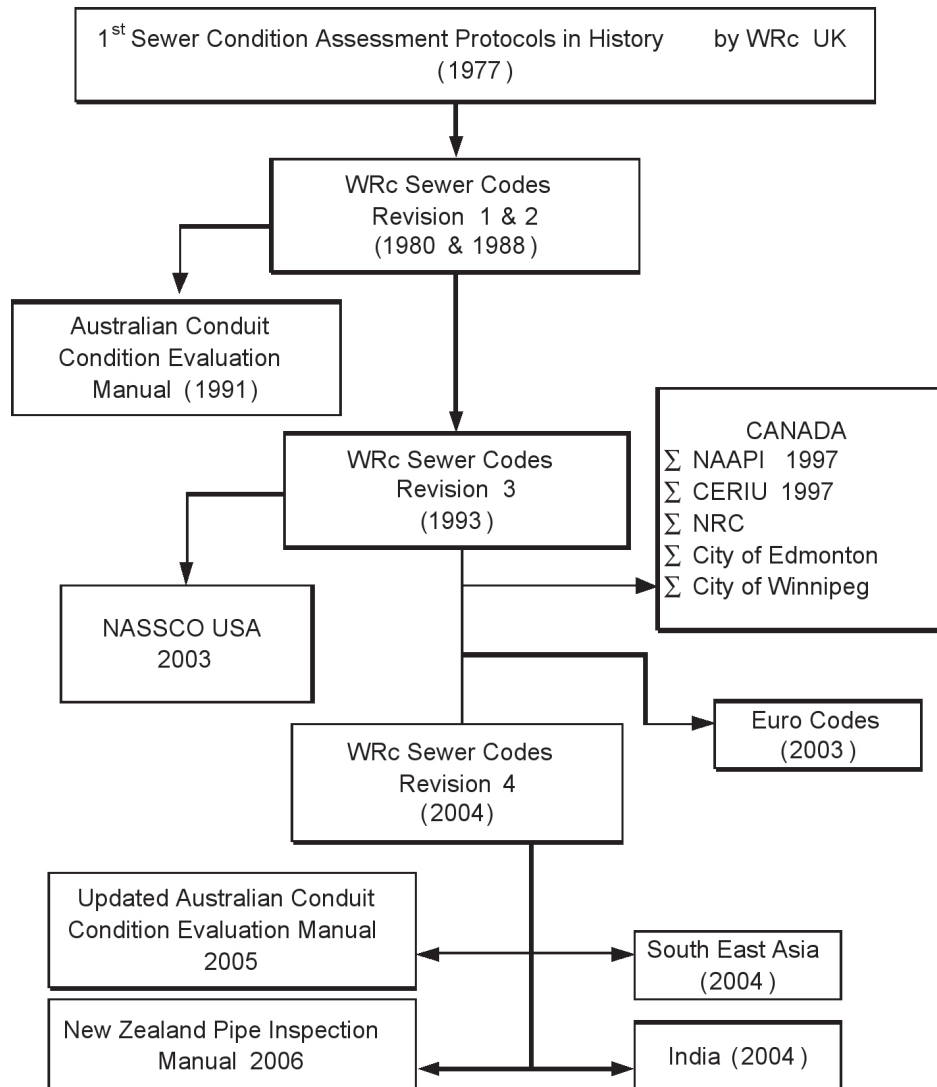

WRc sewer defect coding system. In the Province of Quebec, CERIU (Centre for Expertise and Research on Infrastructures in Urban areas) with the help of BNQ (Bureau de normalisation du Québec) developed the CERIU sewer defect codes in 1997. The CERIU codes have been adapted by most municipalities in the Province of Quebec. WRc and CERIU protocols are the two basic sewer condition assessment codes that have been adapted by most municipal agencies in Canada (Chughtai, 2007).

The WRc protocol divides sewer defects into two major categories: structural and operational. The evaluation of these defects (i.e. number and severity) leads to the assessment of structural and operational condition of the pipeline. In addition to the structural and operational defects,



WRc addresses some additional features, such as construction defects. These defects are used to identify the encountered and pre-existing construction features for connections, manholes, linings, etc. In order to calculate a pipe's condition, sewer defects in the pipe need to be ranked in some order of severity. Based on the severity of defects, an overall sewer internal condition grade (ICG) for the whole pipe segment is identified by a number from 1 to 5 (WRc, 2004) as illustrated in Table 5-17.

**Table 5-17: Severity Condition Grades for WRc Protocol**

Condition Grade	Description	Peak Structural defect Score Found in a Segment	Peak Operational defect Score Found in a Segment
1	Acceptable Condition	< 10	< 1
2	Minimal Collapse Risk but Potential for Further Deterioration	10-39	1 – 1.9
3	Collapse unlikely but Further deterioration likely	40-79	2 – 4.9
4	Collapse Likely in Near Future	80-164	5 – 9.9
5	Collapse Imminent or Collapsed	165 & above	> 10

The ICG for a pipe segment is determined by a defect score calculation that is based on various defects in a pipe segment. The value of each defect, i.e. weight, determines the impact of the defect on the service life and performance of the sewer pipe segment. The total score represents the summations of all deduct values in the pipe segment while the peak score represents the highest deduct value. The mean of the defect scores per meter of pipeline reflects its overall condition (NZWWA, 2006).

The WRc describes structural condition of a pipe in terms of existing defects, such as joint openings and displacements, cracks, holes, deformations, etc. The defect score assigned to structural defects depends upon its severity and pipe material. The defect scores are calculated based on the peak defect score (i.e. deduct value) in which a single structural condition grade is assigned as shown in Table 5-17. On the other hand, operational defects depict the capability of a sewer pipe to meet its service requirements and signify the loss of capacity, potential of blockage and water tightness. The major operational defects include obstructions, debris, encrustations, roots, etc. General guidelines for evaluating the overall operational conditions of pipes are similar to structural conditions. The WRc suggests peak scores in determining

internal condition grade (Rahman et al., 2004). Similar to structural conditions, the defect scores are calculated based on the peak defect score (i.e. deduct value) in which an operational condition grade is assigned as shown in Table 5-17.

The CERIU addresses the issue of sewer pipeline condition assessment in four different scenarios: structural defects, hydraulic defects, infiltration, and junction/connection condition (Chughtai, 2007). It assigns 5 different classes to a particular structural or hydraulic (operational) defect in a sewer pipeline. These numbers consider the intervention or rehabilitation requirements as the key factor for a particular defect in a pipe (Table 5-18).

**Table 5-18: Severity Condition Grades for CERIU Protocol**

CERIU Condition Grade	Description
1	No Intervention, Action Required
2	Action Required but not Major
3	Action Required but Not Urgent
4	Action Required and Urgent
5	Immediate Action Required

On the contrary, CERIU does not suggest overall structural or hydraulic condition classification for a sewer pipeline segment. In order to compare and integrate the two systems into a unified condition assessment protocol, it is necessary to develop internal condition grades (ICGs) for CERIU system similar to WRc protocol. Therefore, the presented research in this paper assists in developing the internal condition grades for CERIU protocol.

### 5.6.3 Self-Organizing Maps

Self-Organizing Maps (SOM) belong to a general class of unsupervised neural network (UNN) methods, which are non-linear regression techniques that can be trained to learn or find relationships between inputs and outputs or to organize data so as to disclose unknown patterns or structures. In the UNN learning, there is no performance evaluation available (Gallant, 1993). Therefore, unsupervised models construct groups of similar input patterns, which are known as clustering. The SOM is a fairly well known neural network and one of the most popular UNN learning algorithms. More than 4000 research articles have been published on the SOM algorithm, its visualization, and applications

(Schatzmann et al., 2003). The SOM consists of neurons organized on a regular low dimensional grid. Each neuron has a “d” dimensional weight vector where “d” is equal to the dimension of input vector. Neurons are connected to the adjacent neurons by a neighborhood relation, which indicates the topology or structure of the map. The SOM output layer depends on the input layer patterns (Shahin et al., 2004).

Self-Organizing Maps belong to a general class of unsupervised neural network methods, which are non-linear regression techniques that can be trained to learn or find relationships between inputs and outputs or to organize data so as to disclose unknown patterns or structures.

#### 5.6.4 Research Methodology

The developed methodology of this research consists of two parts: (1) develop a unified sewer condition classification protocol and (2) integrate structural and operational condition of sewer pipelines into a combined condition index (CCI) using UNN. Based on the severity ranking of different sewer defects in WRc, transformed deduct values for CERIU classifications are generated. The generated values are clustered into five groups using the UNN clustering (Kohonen’s SOM) technique as shown in Figure 5-61.

The principal objective of clustering deduct values is to develop five different condition classes for CERIU protocol, compatible with WRc protocol, for the holistic structural and operational conditions of sewers. In brief, the methodology consists of ranking severity of defects, assigning transformed deduct values for CERIU classification, developing SOMs, and proposing modification in CERIU. This methodology is verified through feedbacks from CERIU sub-committee for the development of a unified condition assessment protocol (2007).

A methodology for predicting sewer’s structural and operational condition information through the use of historical data is developed by Chughtai and Zayed (2008) and Chughtai (2007). Different regression models are designed for three different sewer pipeline materials: concrete, asbestos cement, and PVC. These models are developed on the basis of identified physical, operational, and environmental factors, which contribute to a sewer’s deterioration. Based on these models, structural and operational deterioration curves have been generated to represent a relationship between condition rating and age. The outcome of these models is used to develop a combined condition index (CCI) for sewer pipelines as shown in Figure 5-62.

Figure 5-61:  
Proposed Protocol Integration  
Methodology

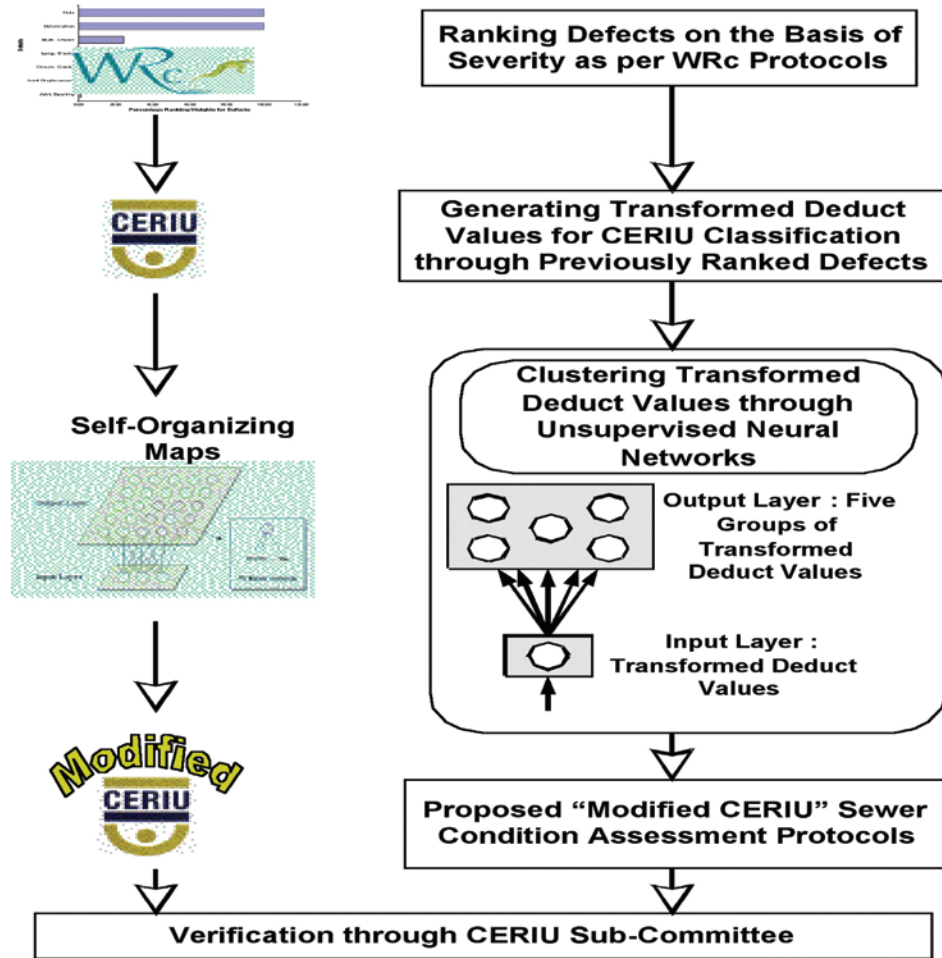
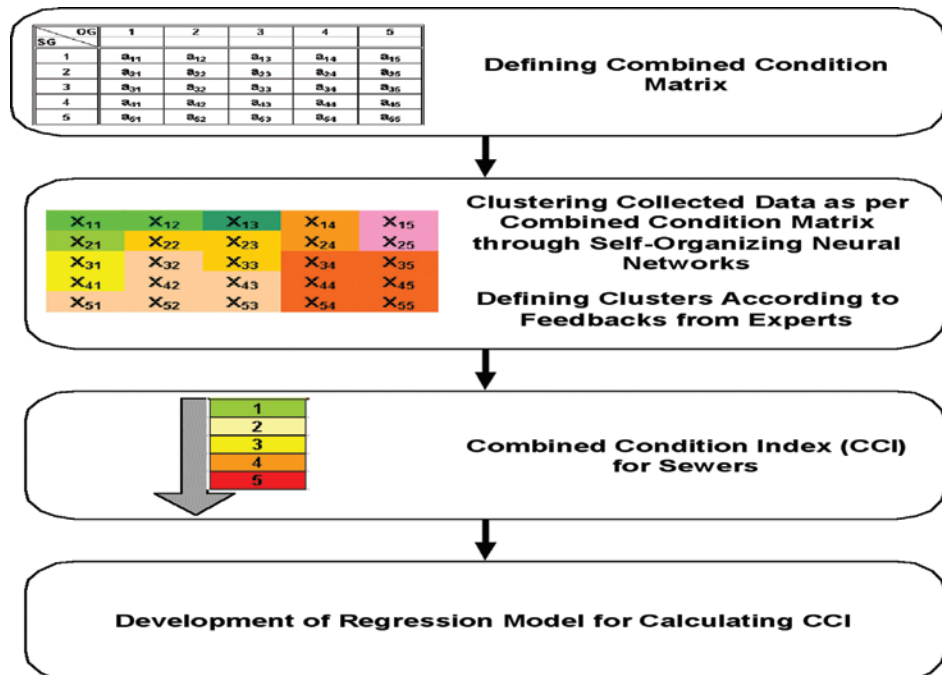

Figure 5-62:  
Development of methodology  
of the Combined Condition  
Index (CCI)



A combined condition matrix is defined by considering all possible scenarios for a sewer's condition. The matrix is clustered into five classes using the SOM. The clusters are developed and examined through feedback from experts and collected data from municipalities. A final combined condition index (CCI) is developed with values vary from 1 to 5; where 1 represents an acceptable combined (structural and operational) condition of a sewer and 5 represents critical combined condition. Further, a regression model is developed to directly determine the value of CCI based upon the structural and operational condition.

### 5.6.5 Data Collection

Data are collected from two municipalities in Canada; Pierrefonds (Quebec) and Niagara Falls (Ontario). The collected data include general pipeline inventory records, AutoCAD drawings, and CCTV inspection reports. Data from Niagara Falls adopt WRc (Water Research Centre, UK) classification system while Pierrefonds data adopt CERIU (Centre for Expertise and Research on Infrastructures in Urban Areas, Canada) classification system. Since the WRc classification system, known as the "Embryo Codes" is accommodated worldwide in sewer rehabilitation industry (Thornhill et al., 2005), data from Pierrefonds is converted, in the developed model, into WRc classification system. The collected data consist of three different categories for pipe material: concrete, asbestos cement, and polyvinyl chloride (PVC). Five different types of bedding material have been specified. Moreover, average annual daily traffic (AADT) above a sewer is defined in terms of street categories as per American Society of Civil Engineers (ASCE) classification: 1- arterial; 2- collector; 3- sub-collector; and 4- access.

### 5.6.6 Modified Ceriu Sewer Pipeline Protocol

The methodology of converting CERIU protocol to WRc is shown in Figure 5-61. This methodology passes through five main steps as discussed in the following sections.

#### 5.6.6.1 Defect Ranking

WRc assigns different peak deduct values for different defects, which means that some defects have more weights than the others in determining the overall condition of a pipeline. For example, longitudinal crack has a maximum deduct value of 15 per crack as compared to 40 for multiple cracks. Consequently, it can be said that a multiple crack affects the overall condition of a pipe 2.67 times more than a longitudinal crack. In this context, all defects can be ranked on the basis of their contribution towards the overall condition of a pipeline. For structural condition assessment, WRc assigns a maximum deduct value of 165 for

a defect. Therefore, the severity of structural defects can be ranked as shown in Table 5-19. For operational condition assessment, WRc assigns a maximum deduct value of 10 for a defect. Therefore, operational defects can also be ranked according to the abovementioned methodology and Table 5-19.

**Table 5-19: WRc Ranking Weights for Common Structural and Operational Defects**

Structural Defects	WRc Maximum Deduct Value	Relative Ranking Weights	Ranking Weights (%)
Joint Opening	2	0.01	1.21
Joint Displacement	2	0.01	1.21
Circum. Cracks	8	0.05	4.85
Long. Cracks	15	0.09	9.09
Multi. Cracks	40	0.24	24.24
Deformation	165	1.00	100.00
Hole	165	1	100.00
<b>Operational Defects</b>			
Roots	10	1.00	100.00
Encrustation	5	0.50	50.00
Debris	10	1.00	100.00
Obstruction	10	1.00	100.00

### 5.6.6.2 Assigning Transformed Deduct Values for CERIU Classifications

The deduct values, i.e. weights, for defects are assigned according to the utilized condition assessment protocol. They determine the impact of defects on the service life and performance of a sewer pipe segment. Deduct values for defects should be assigned in a consistent manner (Rahaman et al., 2004). Therefore, care should be taken into account while proposing deduct values for CERIU classification in order to be consistent and compatible with other protocols. The developed methodology assigns deduct values for CERIU classification by multiplying WRc severity ranking weight with the specified CERIU class for a particular defect. Table 5-20 presents the obtained deduct values for CERIU classification using some common structural and operational defects. These values have been transformed from their respective ranking weights using WRc classification.

Table 5-20: Transformed Deduct Values of Structural and Operational Condition Classes (CERIU)

Structural Defects	WRc Ranking Weights	Transformed Deduct Values for CERIU Condition Classes (Ranking Weight * CERIU Condition Class)				
		Class 1	Class 2	Class 3	Class 4	Class 5
Joint Opening	0.01	0.01	0.02	0.03	0.04	–
Joint Displacement	0.01	–	0.02	0.03	0.04	0.05
Circum. Crack	0.05	0.05	0.1	0.15	0.2	0.25
Long. Crack	0.09	0.09	0.18	0.27	0.36	0.45
Multi. Crack	0.24	0.24	0.48	0.72	0.96	1.2
Deformation	1	–	–	–	4	5
Hole	1	–	–	3	4	5
<b>Operational Defects</b>						
Roots	1	1	2	3	4	5
Deposits	0.5	0.5	1	1.5	2	2.5
Grease	1	1	2	3	4	5
Visible Material	1	–	2	3	4	5
Obstruction	1	1	–	3	–	5

### 5.6.6.3 Development of Self-Organizing Maps

Overall condition class of a pipe can be calculated using either peak or mean deduct values where peak score represents the highest deduct value and mean score represents the average of deduct values for a particular pipe segment. For simplicity, the method of peak deduct values has been adapted in developing the modified CERIU classification system. In order to develop an overall structural or operational condition grading system for CERIU classification, the obtained transformed deduct values, as shown in Table 5-20, need to be grouped or clustered. For this purpose, self-organizing maps are developed through unsupervised neural network applications. The clustering or groupings of deduct values for structural and operational grades are done separately. The input layer consists of transformed deduct values, and

Overall condition class of a pipe can be calculated using either peak or mean deduct values where peak score represents the highest deduct value and mean score represents the average of deduct values for a particular pipe segment.

the output layer represents the topology of five groups for these values. The transformed deduct values for structural defects (Table 5-20) are taken as the input values for the development of self-organizing map.

The network is trained using 500 to 500,000 epochs in order to generate the desired five-category output. The initial learning rate was 0.5 and neighborhood size was taken as 4. During the process of training, the learning rate and neighborhood size eventually decreased to 0.000001 and 0, respectively. Several iterations are performed in order to achieve the objective of 5 groups in the output layer. The clusters obtained from this process are shown in Figure 5-63.

**Figure 5-63:**  
Categorical Output for CERIU  
Transformed Deduct Values of  
Structural Defects

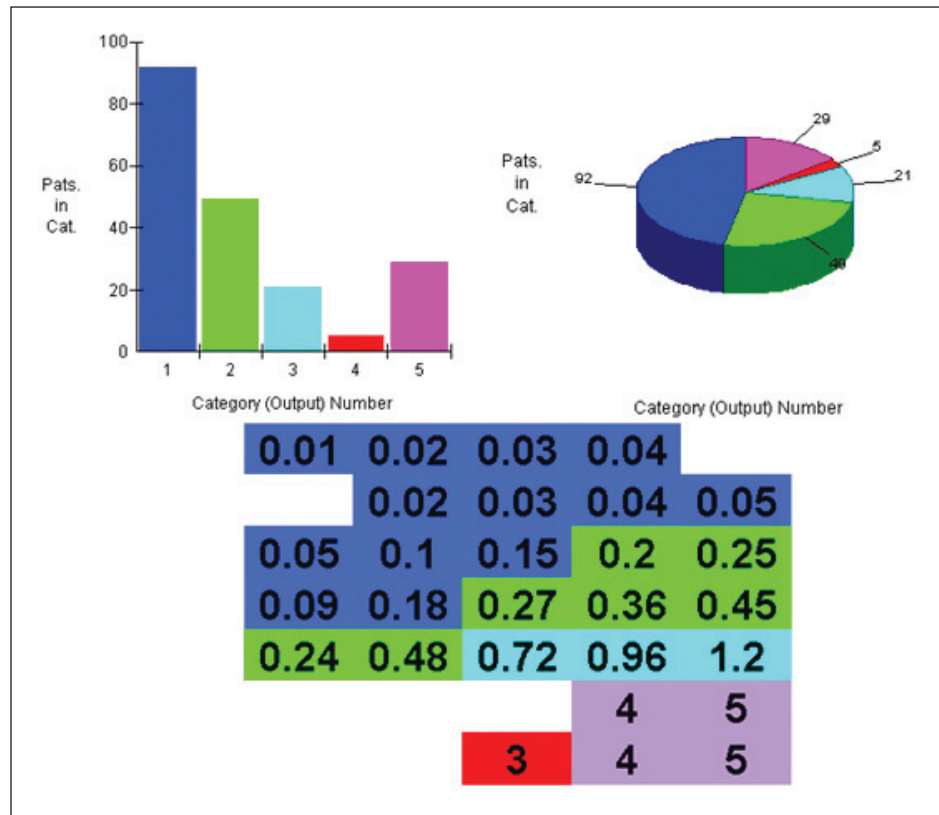

The class boundaries of the obtained clusters, using Kohonen self-organizing maps, are presented in Table 5-21. Similar methodology is adapted in grouping operational deduct values where the final outcome is presented in Table 5-21.



Table 5-21: Group Divisions for CERIU Transformed Deduct Values for Structural Defects

SOM Groups	Transformed Deduct Values	
	Structural	Operational
Group # 1	0.01, 0.02, 0.03, 0.04, 0.05, 0.09, 0.1, 0.15, 0.1	0.5, 1
Group # 2	0.2, 0.24, 0.25, 0.27, 0.36, 0.45, 0.48	1.5, 2
Group # 3	0.72, 0.96, 1.2	2.5, 3
Group # 4	3	4
Group # 5	4, 5	5

#### 5.6.6.4 Proposed Modification in CERIU Protocols

The class boundaries for each group or cluster can be easily defined from the SOM's results that are tabulated in Table 5-21. For example, in Table 5-21, group no 1 (i.e. the structural transformed deduct values) has a minimum deduct value of 0.01 and maximum of 0.18. Therefore, the peak value for this group is 0.18. Further, this maximum value is less than all values of group 2, which will be the minimum value in this group. Similarly, the rest of groups are composed. This shows a holistic picture of developed self-organized condition classes for both structural and operational defects. These condition classes are tabulated separately for structural and operational conditions in Table 5-22. The obtained peak transformed deduct values for CERIU classifications of structural and operational defects are compared to their corresponding WRc deduct values as shown in Table 5-23. According to Tables 5-22 and 5-23, the condition assessment using both protocols can be considered transferable.

Table 5-22: Holistic CERIU Structural and Operational Condition Classes for Sewers

Proposed Overall CERIU Structural and Operational Condition Class	Peak Structural Transformed Deduct Values	Peak Operational Transformed Deduct Values
1	$\leq 0.18$	$\leq 1.00$
2	0.19 – 0.48	1.1 – 2
3	0.49 – 1.2	2.1 – 3
4	1.21 – 3	3.1 – 4
5	$> 3$	$> 4$

Table 5-23:

Comparison between the Structural and Operational Condition Classes of the Modified CERIU and WRc According to Peak deduct Values

Condition Class	Structural Deduct Value		Operational Deduct Value	
	Modified CERIU	WRc	Modified CERIU	WRc
1	≤ 0.18	< 10	≤ 1.00	< 1
2	0.19 – 0.48	10-39	1.1 – 2	1 – 1.9
3	0.49 – 1.2	40-79	2.1 – 3	2 – 4.9
4	1.21 – 3	80-164	3.1 – 4	5 – 9.9
5	> 3	165 & above	> 4	> 10

#### 5.6.6.5 Results of Model Implementation and Verification

The sewer inspection data for the municipality of Pierrefonds, Quebec, were transferred from CERIU into WRc protocol. It could be easily understood from the results that the proposed CERIU modification methodology was helpful in integration of complex CERIU sewer inspection data into easy to understand WRc condition rating system. The results of the developed methodology were introduced to the committee that was responsible for updating CERIU protocol. The committee admired the work and considered it as very interesting and promising. It acknowledged that the question of modifying CERIU protocol had been lingering for a long time within the community and there was an urgent need to react and address this issue. The committee also agreed that the proposed conversion factors would be helpful in providing a documented link between CERIU and WRc condition classification systems.

#### 5.6.7 Combined Condition Index (CCI) for Sewer Pipelines

It is apparent that the WRc and modified CERIU protocols provide the expert with two indices: structural and operational.

It is apparent that the WRc and modified CERIU protocols provide the expert with two indices: structural and operational. This might be confusing in many occasions such that a pipeline might be structurally sound though it is operationally deteriorated and vice versa. Such situations make the condition of this pipeline questionable and generate confusion to experts. Therefore, there is a need to develop a combined condition rating system for sewers using the methodology in Figure 5-62. This system considers both structural and hydraulic conditions of a pipeline simultaneously. It is developed using the WRc protocol.

As described, a sewer's existing condition is usually defined in two ways: structural and operational conditions. These conditions are assessed using a scale from 1 to 5, where 1 represents the good and 5 the worst. The challenge arises when a pipe has, for example, structural condition rating of 1 and operational condition rating of 5. According to a certain code, what would be the criteria of judging the overall condition of that pipe? In order to better understand this situation, let us consider the matrix in Figure 5-64.

OG \ SG	1	2	3	4	5
1	$a_{11}$	$a_{12}$	$a_{13}$	$a_{14}$	$a_{15}$
2	$a_{21}$	$a_{22}$	$a_{23}$	$a_{24}$	$a_{25}$
3	$a_{31}$	$a_{32}$	$a_{33}$	$a_{34}$	$a_{35}$
4	$a_{41}$	$a_{42}$	$a_{43}$	$a_{44}$	$a_{45}$
5	$a_{51}$	$a_{52}$	$a_{53}$	$a_{54}$	$a_{55}$

Legends	
OG	WRC Operational/Service Grades
SG	WRC Internal Structural Condition Grades
	Balanced Deterioration of pipe
	Pipe Structurally Deteriorated
	Pipe Hydraulically Deteriorated

Figure 5-64:  
Sewer Pipeline Combined  
Condition Matrix

This matrix considers all possible combinations of structural and operational conditions for a sewer as per WRC specification. Therefore, this matrix ( $a_{ij}$ ) is a square matrix of order 5 where  $i$  and  $j$  represent the possible structural and operational condition ratings of a pipeline, respectively. It can be noticed that a balanced pipeline deterioration occurs if  $i = j$ . However, the pipeline will be more structurally deteriorated if  $i > j$  and more operationally deteriorated otherwise. The matrix also shows that there are 25 possible scenarios for assigning a combined condition of a sewer.

### 5.6.7.1 Clustering the Combined Condition Matrix

The idea of clustering the combined condition matrix through unsupervised neural network is introduced in the same fashion as have been carried out for the modified CERIU protocol. The main objective is to generate five well-defined clusters out of the 25 possible scenarios of defining overall condition classes for a sewer pipeline. Consequently, the combined condition index (CCI) for sewer pipelines can be developed. Data obtained from the municipality of Niagara Falls, Canada, are chosen for this clustering operation. Total 966 data points are available, which show the required description of a pipe's structural and operational condition rating. All these values are taken as the input values for the SOM. The input layer is trained from 500 to 500,000 epochs in order to generate the desired five-category output. The initial learning rate is 0.5 and neighborhood size is taken as 4. The output layer design for neurons is set at 5 neurons as five clusters are desired. Furthermore, the pattern selection criterion for clusters is set at random and the Euclidean

distance is used to measure the distance between the clusters. During the process of training, the learning rate and neighborhood size eventually decrease to minimum possible value of 0.000001 and 0, respectively. The clusters obtained during this process are presented in Table 5-24. Table 5-24 clearly indicates that the obtained clusters have been transformed into five well-defined categories. These clusters have been sorted according to the criticality of structural condition ratings and then according to the criticality of operational condition ratings.

**Table 5-24: The Five Categories of the Combined Condition Index (CCI)**

Cluster Number	Structural Condition Rating	Operational Condition Rating
1	1 to 2	1 to 3
2	1 to 2	4 to 5
3	3 to 4	1
4	3 to 4	2 to 3
	3 to 5	1 to 3
5	3 to 5	4 to 5

### 5.6.7.2 The Proposed Combined Condition Index for Sewer Pipelines

Based on the five clusters, a combined condition index (CCI) for sewer pipelines is developed. Table 5-25 shows the description of the proposed combined condition index (CCI) for sewers.

Based on the five clusters, a combined condition index (CCI) for sewer pipelines is developed

Table 5-25: Proposed Combined Condition Index (CCI) for Sewers

Combined Condition Index (CCI)		Equivalent WRc (UK) Internal Condition Grades (ICG)		Description	Action Required
Numeric Scale	Linguistic Scale	Structural Grading	Operational Grading		
1	Acceptable	1 to 2	1 to 3	Acceptable overall condition	Routine Monitoring
2	Adequate	1 to 2	1 to 3	Overflow problems	Cleaning and Flushing
3	Moderate	3 to 4	2 to 3	Collapse risk with no overflows (Light to medium cracks / deformation)	Low Rehabilitation Priority
				Light to moderate service connection / construction defects	Medium Rehabilitation Priority
4	Poor	3 to 5	2 to 4	Greater collapse risk with minimal overflow problems (Medium to severe cracks/ deformation)	Medium Rehabilitation Priority
				Medium to severe service connection / construction defects Risk of basement flooding and end user complaints	High Rehabilitation Priority
5	Critical	3 to 5	4 to 5	Extreme collapse risk with overflow problems (Medium to severe cracks / deformation) Severe service connections / construction defects Extreme Overflows with basement flooding and loss of property	Immediate Rehabilitation Priority

Each class or index has well defined boundaries for its respective structural and operational condition classes.

Each class or index has well defined boundaries for its respective structural and operational condition classes. This index is divided into 5 categories, ranging from “1” to “5,” and linguistically, from “Acceptable” to “Critical.” The index has been proposed by giving more weights to a sewer’s structural condition for defining the rehabilitation or

action requirements. In addition, criteria for assessing risk of collapse and flooding is defined for each class. The proposed remedial actions depend upon the developed risk criteria for collapse, over flow and basement flooding problems, as well as impact assessment factor. These criteria have been developed through the general guidelines provided by experts, which will be discussed in the next section of this paper. The integration of all scenarios in defining a specific class of the CCI will be helpful in understanding the overall condition of sewers. For example, if the CCI is “1” for a certain sewer, it has an acceptable overall condition; therefore, no particular action except routine monitoring is required. On the contrary, if a pipe has CCI value of “5,” immediate rehabilitation action is proposed. In this context, the proposed combined condition index is intended to provide a framework for municipal engineers to decide and plan maintenance and rehabilitation actions for sewer networks.

### 5.6.7.3 Verification of the Proposed CCI

In order to verify the proposed CCI, a questionnaire is designed and has been sent to different municipal experts and consultants. The questionnaire consists of three basic questions:

1. Is the index adequate according to maintenance and rehabilitation requirements?
2. Does the index require some revisions/reassessments in terms of assigned equivalent WRc structural and operational condition class boundaries?
3. Are the defined criteria for each category of the index acceptable?

Three out of four municipal practitioners agreed on the point that the idea of combining structural and operational condition ratings into a single scale will help municipal engineers prioritize.

Four comprehensive feedbacks have been received from experts. Three out of four municipal practitioners agreed on the point that the idea of combining structural and operational condition ratings into a single scale will help municipal engineers in prioritizing detailed inspection, maintenance, and rehabilitation operations. However, one expert suggested that structural and operational conditions should be analyzed separately. The

important comments from experts have already been embraced into the description of different classes of CCI (i.e. Table 5-25). Comments of experts were summarized as follows:

- Pipes collapse occurs for reasons like severe cracking or exposed aggregate due to hydrogen sulfide or chemical attack. Light, moderate, or severe cracking should be considered in determining collapse risk.
- There are other defect conditions that may cause overflow problems similar to a fail pipe. These defects may include tree root intrusions, debris, or encrustations etc. Depending on the severity, the required action may range from cleaning to immediate rehabilitation.
- In all separated sewer systems and some combined systems, collapsed pipes may cause flooded basements instead of overflow problems. The response to flooded basements may require a higher rehabilitation priority than the priority given to overflow.
- A good CCI should also cover construction defects such as sags in the pipe, protruding services, and misaligned joints, etc.
- Pipe rehabilitation is expensive and also depends upon available resources, budget, location, etc.

#### 5.6.7.4 Automated Conversion of Structural and Operational Ratings into CCI

To facilitate an automated conversion of a sewer's structural and operational condition observations into CCI, a regression model is designed. All the possible scenarios shown in Table 5-25 are taken as input data for the model. The response variable "CCI" is regressed against its corresponding values of predictor variables (structural and operational ratings) using the Minitab® statistical software. Equation (1) shows the final outcome of the adapted procedure, which clearly indicates that CCI can be found for any sewer if its structural and operational conditions are known. The structural and operational condition ratings are according to WRc classification.

$$CCI = \sqrt{0.541 + 0.273(\text{Structural\_Condition\_Rating}) + 0.37(\text{Operational\_Condition\_Rating})} \quad (1)$$



Equation (1) is verified through the necessary statistical diagnostics as well as validation checks. Some of the important statistical and validation diagnostics are shown in Table 5-26. The fitted response plane for the regression model is shown in Figure 5-65. It shows the variation in response (CCI) with the variations in predictors (structural and operational condition ratings).

Table 5-26: Important Statistical and Validation Diagnostics for the CCI Regression Model

R <sup>2</sup> (%)	R <sup>2</sup> <sub>adj</sub> (%)	P (F)	P (t)			Validation	
			β <sub>0</sub>	β <sub>1</sub>	β <sub>2</sub>	AIP (%)	AVP (%)
81.2	81.1	0.000	0.000	0.000	0.000	20.80	79.20

Figure 5-65: Fitted Response Plane Plot

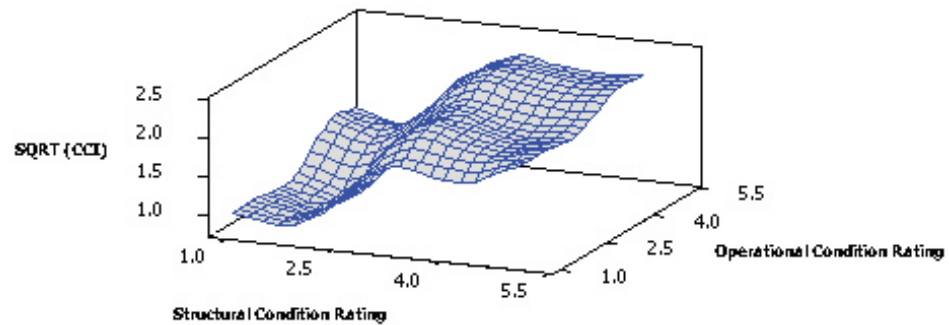

The developed model in Equation (1) is checked for statistical validity. The main diagnostics in this regard are  $R^2$  (coefficient of multiple determination), F-test, and t-test. The results shown in Table 5-26 illustrate that 81.2% of the total variability in a sewer pipe's condition can be explained through the developed regression equation. Both values of  $R^2$  and  $R^2$ -adjusted indicate that the model fits the data well. To determine  $P(F)$  for the whole model, a hypothesis test is carried out. The null hypothesis ( $H_0$ ) assumes that all regression coefficients,  $\beta_0, \beta_1 \dots \beta_{p-1}$  are zero i.e.  $\beta_0 = \beta_1 = \beta_{p-1} = 0$  and the alternate hypothesis ( $H_a$ ) assumes that not all of them equal to zero. Based on the Minitab's output the p-value for the F-test is 0.000 (Table 5-26). This means that null hypothesis is rejected. Similarly, to determine the validity of regression coefficient individually, "t-tests" are performed separately for the  $\beta_0, \beta_1 \dots \beta_{p-1}$ . In case of  $\beta_0$ , the null hypothesis ( $H_0$ ) of t-test assumes that  $\beta_0 = 0$ ; while alternative hypothesis ( $H_a$ ) assumes that  $\beta_0 \neq 0$ . Similarly, the other null hypothesis assumes that  $\beta_1 = 0$  and vice versa. The results of these tests, for all models, indicate that the p-value for intercept is 0.000 in which alternative hypothesis is accepted with 95% confidence. Similar procedure is performed to check the soundness of other regression coefficients associated to each predictor. The overall results of t- test are found satisfactory and acceptable.

### 5.6.7.5 Validation of CCI Regression Model

The validation data are embedded into the CCI regression model in order to compare their results with the actual results. Models are validated utilizing two basic criteria shown in Equations 2 and 3 as follows (Chughtai and Zayed, 2008):



$$AIP = \frac{\sum_{i=1}^n \left| 1 - \left( \frac{E_i}{C_i} \right) \right|}{n} * 100 \quad (2)$$



$$AVP = 100 - AIP \quad (3)$$



Where, *AIP* is average invalidity percent, *AVP* is average validity percent,  $E_i$  is estimated or predicted value,  $C_i$  is actual value, and  $n$  is the number of observations.

The values of *AIP* vary from 0 to 1 in which if their values are close to 0, the model is sound in fitting the data. If their values are close to 1, the model is not appropriate for its validation data. Table 5-26 shows the summary of validation results for the CCI model. Results show that *AIP* and *AVP* (Table 5-26) are in the satisfactory range. For example, the value of *AIP* is 20.80%, which shows that the developed model is good in representing the collected data.

### 5.6.8 Summary and Conclusions

The present research work leads to the development of a combined condition index (CCI) for sewer pipelines. The index has five different categories varying from 1 to 5; where 1 represents acceptable combined (structural plus operational) condition of a sewer, and 5 represents a sewer's critical condition. The proposed index will help municipal engineers in visualizing the combined effects of structural and hydraulic problems on a sewer's existing condition. The research also proposes modifications to CERIU sewer condition assessment protocols in order to facilitate its conversion into WRc. This will be helpful for municipal engineers in unification and standardization of sewer condition assessment protocols.

### 5.6.9 Acknowledgment

The authors would like to express their gratitude to the Quebec funding agency NATEQ/FQRNT (Fonds Québécois de la Recherche sur la Nature et les Technologies) for its appreciated financial support to this research. They would also like to extend their appreciation to all municipal engineers who facilitated the authors' research by positive participation and providing the required data, particularly Niagara Falls, Ontario and Pierrefonds, Quebec municipalities.

### 5.6.10 References

CERIU (2004). “*Manuel de Standardization des Observations*,” 2nd Edition, Centre for Expertise and Research on Infrastructures in Urban Areas (CERIU), Montreal, Quebec, Canada.

Chughtai, F. and Zayed, T. (2008). “*Infrastructure Condition Prediction Models for Sustainable Sewer Pipelines*,” J. of Performance of Constructed Facilities, ASCE, September/October, 22(5): 333-341.

Chughtai, F. (2007). “*Integrated Condition Assessment Models for Sustainable Sewer Pipelines*,” Master Thesis, Department of Building, Civil and Environmental Engineering, Concordia University, Montreal, Canada, March.

Gallant, S. (1993). “*Neural Network Learning and Expert Systems*,” The MIT press, England.

Kulandaivel, G. (2004). “*Sewer Pipeline Condition Prediction using Neural Network Models*,” Master Thesis, Michigan State University, MI, USA

NZWWA, (2006). “*New Zealand Pipe Inspection Manual*,” 3rd Edition, New Zealand Water and Waste Water Association, New Zealand.

Rahman, S. and Vanier D. (2004). “*An Evaluation of Condition Assessment Protocols for Sewer Management*,” National Research Council (NRC) of Canada, Research Report Number B-5123.6, Ottawa, ON, Canada.

Schatzmann, J. and Ghanem, M. (2003). “*Using Self-Organizing Maps to Visualize Clusters and Trends in Multidimensional Datasets*,” Case Project Report, Imperial College, London, UK.

Shahin, M., Mair, H. and Jaksa, B. (2004). “*Data Division for Developing Neural Networks Applied to Geotechnical Engineering*,” Journal of Computing in Civil Engineering, ASCE, April, 18(2), pp. 105-114.

Thornhill, R. and Wildbore, P. (2005). “*Sewer Defect Codes: Origin and Destination*,” U-Tech for Utility Construction & Rehabilitation, Underground Construction, April.

WRc (2004). “*Sewerage Rehabilitation Manual*,” 4th Edition, Water Research Centre, UK.

## 5.7

## Strength Prediction for Adhesive Anchors: Elastic Analysis

*H.M. Yin<sup>14</sup> and R.B. Testa<sup>15</sup>*

### 5.7.1 Introduction

For at least 35 years, epoxies have been widely used with threaded rods and reinforcing bars to make adhesive anchor systems. Because the curing time of adhesive products is rapid and this technology has succeeded in many projects, a sense of security has developed in adhesive anchor systems as safe, fast, and economical choices. All that is required is that the strength of the adhesive layer is enough to resist the service loading. But in reality, the effects of creep in epoxy adhesive anchor system have been one of the greatest concerns since the birth of this technology (ICC 1995, Doerr and Klingner 1989, Ferry 1980). Yet, specifically in transportation systems, the absence of test protocols and standards means that the creep behavior of epoxy adhesive anchor systems has not been explicitly specified or characterized, which has produced some potential safety problems.

One of extreme cases was the ceiling collapse in the Interstate 90 connector tunnel in Boston, MA on July 10, 2006. A total about 26 tons of concrete and associated suspension hardware fell down due to the poor creep resistance of the epoxy anchor adhesive system (NTSB 2007). The accident investigation singled out:

- Insufficient understanding among designers and builders of the nature of adhesive anchoring systems;



Adhesive anchors have been widely used in both new construction and repair/retrofit projects because of their rapid curing speed and economy. They are thus especially attractive for use in sustaining aging infrastructure. However, recent accidents have shown that current design and installation procedure may not be safe. Although several failure modes exist in engineering practice, this paper focuses on failure due to pullout of an adhesive core. A rational examination of the current elastic model was conducted; the authors present the model's limitations and a new elastic model is developed. An axisymmetric problem is studied for an adhesive core bonded to a rigid hole through an adhesive layer. The stress distribution within the adhesive interlayer is derived so that the load capacity of the anchor can be obtained. Compared with the existing design method, the proposed model provides the elastic fields at both the adhesive core and the adhesive layer, which makes it possible to capture different failure mechanisms.

**INFRASTRUCTURE TYPE:** Adhesive anchors into concrete

<sup>14</sup> Associate Professor, Department of Civil and Engineering Mechanics,, Columbia University, New York, New York, 10027

<sup>15</sup> Associate Professor, Department of Civil and Engineering Mechanics,, Columbia University, New York, New York, 10027

- Lack of standards for the testing of adhesive anchors in sustained tensile-load applications;
- Inadequate regulatory requirements for tunnel inspections; and
- Lack of national standards for the design of tunnel finishes.



A rational analysis of the stress distribution will be essential for structural design and failure analysis.

Because of the associated safety issues, these conclusions point to the need to understand the failure mechanisms and develop appropriate test methods to standardize future construction practice in structural engineering and to assure safety performance of existing epoxy anchor systems. To these ends, a rational analysis of the stress distribution will be essential for structural design and failure analysis.

Figure 5-66:  
Schematic illustration of an epoxy adhesive anchor system under a tensile load. (a) Typical adhesive anchor assembly; (b) Model of an adhesive anchor

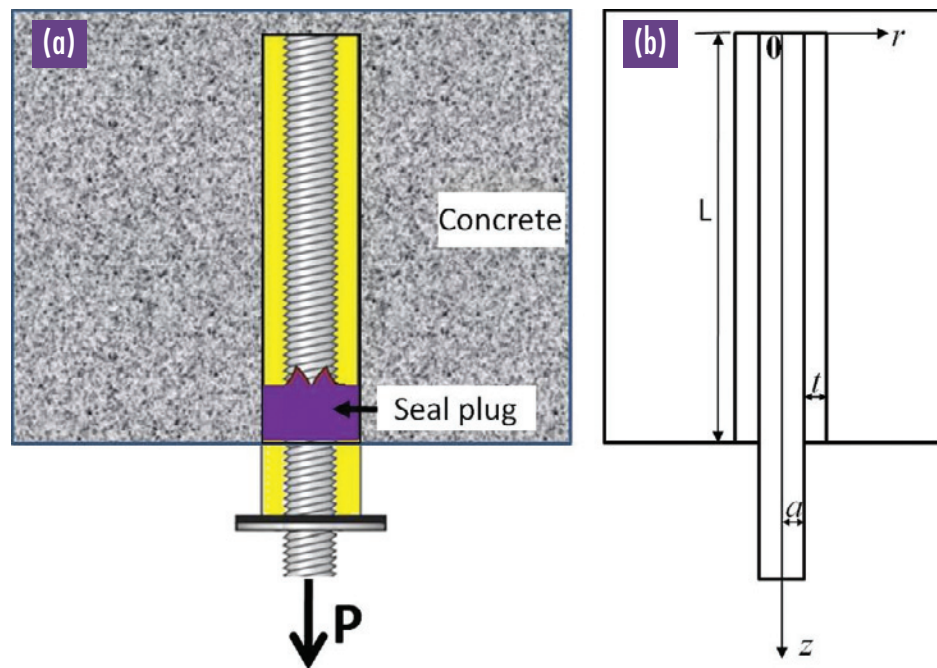

In an adhesive anchor system schematically shown in Figure 5-66(a), a hole is first drilled within the concrete material. Adhesive, such as epoxy, vinylester, and polyester, is pumped into the hole. An anchor rod is then pushed into the hole and it bonds to the concrete through the adhesive layer. Typically, the rod diameter is 13 or 16 mm, the hole diameter is 3.2-12.7 mm larger than the rod diameter, and the embedment depth is at least 10 times the rod diameter (ACI, 1992; Colak, 2007). If the thickness of the adhesive layer is comparable to rod radius, creep behavior becomes a bigger concern for the anchor system.

A tensile load applied at the bottom of the threaded rod is transferred through shear stress along the lateral surface and tensile stress along the top surface to the concrete. If the shear stress is higher than the shear strength of the epoxy, de-bonding along the lateral surface will be induced. If the tensile stress is higher than the interfacial tensile strength, de-bonding will occur at the top surface. Although the interfacial tensile strength is much higher than the shear strength, when the adhesive core or rod is significantly stiffer than the adhesive and embedment depth is not large, the load will mostly be transferred to the top end, and the top de-bonding will first be induced. Then, the load will be transferred through the shear stress along the lateral surface. In that case creep of the adhesive layer becomes most important.

A tensile load applied at the bottom of the threaded rod is transferred through shear stress along the lateral surface and tensile stress along the top surface to the concrete.

On the other hand, if the embedment depth is quite large and the adhesive layer is not very thick, the maximum shear stress at the bottom of the hole may reach the shear strength first, and de-bonding may start at the bottom and propagate toward the top until the top de-bonding is induced. Because the design of adhesive anchors typically specifies a large embedment depth and a fairly thin adhesive layer, most failure modes fall into the second category: lateral de-bonding occurs first and propagates toward to the top of the hole. In effect, the anchor bonding unzips. Ideally an adhesive anchor should be designed so that there is no de-bonding in service.

In the existing design method, the critical loading is typically obtained by elastic analysis (Cook and Konz, 2001; Colak, 2001, Cook, Doerr, and Klingner, 1993; Doerr and Klingner, 1989) with an assumption of uniform shear bond stress. The uniform shear bond mode only addresses the lateral debonding of the adhesive core, and although a large safety factor is applied (Eligehausen, Cook and Appl, 2006; Cook, Kunz, et al., 1998), it does not assure safety for other failure mechanisms. In addition, the elastic shear stress can vary in the embedment depth and be different in the thickness direction of the adhesive layer. The uniform shear bond model cannot capture the stress distribution in the thickness direction and, as a result, often gives unrealistic predictions.

With some calibrations using actual test data, the uniform bond stress model can provide good approximation of single adhesive anchor tensile strength for short-term pullout results (McVay, Cook and Krishnamurthy, 1996; Cook, Kunz, et al., 1998), a rational elastic analysis, which predicts the critical loading from the fundamental material properties, will reduce or eliminates the experiments in design of adhesive anchors and

produce more reliable and general results. In addition, a whole picture of elastic field will provide valuable information for construction guidelines and quality control tests, which assure material strength at critical stress area.

This paper presents an elastic solution for the adhesive layer under the pullout load applied to the adhesive core. This model will serve as a baseline for future visco-elastic analysis which, because, in the long-term, the adhesive layer exhibits visco-elastic properties (Yin et al., 2008a), the creep behavior and its effect on failure become more important. With an improved elastic solution as a base, the time dependent response can then be studied.

### 5.7.2 The Uniform Bond Stress Model

In current design of adhesive anchors, the adhesive layer is taken as an elastic material, and the shear stress distribution across the thickness of the adhesive layer is assumed to be uniform (Cook, Doerr and Klingner, 1993). In Figure 5-66(a), the adhesive core is assumed to be a one dimensional (1D) bar. The normal force is balanced by the shear force, so the governing equation with respect to the displacement  $w$  is written as

 Equation

$$w_{,zz} - \left( \frac{k}{E_c A} \right) w = 0, \quad (1)$$

where  $k$  is the shear stiffness,  $E_c$  Young's modulus of the anchor core, and  $A$  the sectional area of the adhesive core with a radius  $a$ .

In the adhesive layer, the shear strain is assumed to be constant across the thickness

 Equation

$$\gamma_{zr} = \frac{w}{t} = \frac{\tau_{zr}}{G_a}, \quad (2)$$

where  $G_a$  is the shear modulus of the adhesive layer.

From the above equation, the shear stiffness can be written as

 Equation

$$k = \frac{\pi d \tau_{zr}}{w} = \frac{G_a 2\pi a}{t}. \quad (3)$$

Solving Eq. (1) with the boundary conditions that the top surface is free for  $z = L$ , and the bottom section has resultant force  $P$ , i.e.,

 Equation

$$E_c A w_{,z} = P \text{ for } z = L. \quad (4)$$

one can obtain the displacement as

$$w(z) = \frac{P \cosh(\lambda z)}{E_c A \lambda \sinh(\lambda L)} \text{ with } \lambda = \sqrt{\frac{2G_a}{tE_c a}} \quad (5)$$

 Equation

Notice that the top surface is glued to the top of concrete hole and not supposed to be free, which will change the form of the solution. In the proposed model, a fixed end boundary condition will be used.

When  $z = L$ , i.e., where the anchor enters the hole, the shear stress reaches the maximum. At the moment of failure, the stress will be at the shear strength of adhesive materials, i.e.,

$$\tau_{max} = \frac{G_a w(L)}{t} = \frac{G_a}{E_c \pi a^2 \lambda t \tanh(\lambda L)} P_n \quad (6)$$

 Equation

where  $P_n$  denotes the load capacity of the anchor. Therefore, the load capacity can be written as

$$P_n = \frac{\tau_{max} \pi a^2 \lambda t \tanh(\lambda L)}{G_a} \quad (7)$$

 Equation

In the actual design, values of  $\tau_{max}$  and  $\lambda$  are determined by experiments with trial anchors using the same configuration and materials.

The derivation of the uniform bond stress model imposes the following limitations of the applications:

- Because the shear stress distribution in the thickness direction is assumed to be uniform, the maximum shear stress cannot be accurately located. Using the averaged stress in the thickness direction to compare with the shear strength may overly estimate the load capacity of the anchor.
- Due to the uniform shear stress in the thickness direction, the force equilibrium for the adhesive layer is lost: i.e. the integral of shear stress along the outer surface is higher than that along the inner surface. Therefore, this approximation can only be applicable to anchors with very thin adhesive layer.
- Eq. (5) implies that the top of the anchor is always separated from the top of the hole even if the load  $P$  is very small. The later calculation will show that only a very small adhesive stress is needed to keep the integrity of the top surface.
- Due to the rough assumptions, the value of  $\lambda$  determined by Eq. (5) with the fundamental mechanical constants and geometry parameters are not directly used, but has to be calibrated with prototypic experiments with the same materials.

Therefore, this model can be only applicable for very thin adhesive layers. However, this model has been widely used for adhesive anchor design with thick adhesive layers (Cook et al., 1998; Colak 2001; 2007). In addition, the displacement and stress distribution in the adhesive layer cannot be accurately determined from this 1D model. Moreover,



To completely understand the failure mechanism and load capacity of adhesive anchors, full solutions that are based on the complete set of governing equations for the elastic boundary-value problems must be used.

this model cannot be extended to the creep failure mechanism for adhesive anchors. To completely understand the failure mechanism and load capacity of adhesive anchors, full solutions that are based on the complete set of governing equations for the elastic boundary-value problems must be used.

### 5.7.3 Basic Formulation

Here, a simplified axisymmetric, elastic solution of the stress distribution in the adhesive layer will be derived to satisfy the detailed boundary conditions.

Consider a cylindrical adhesive core with a radius,  $a$ , embedded into a circular hole with a radius  $b = a + t$  in a concrete block (see Figure 5-66), so that the thickness of the adhesive layer is  $t$ . The embedment depth or bonded length is  $L$ . The Young's modulus and Poisson's ratio of adhesive layer are denoted by  $E_a$  and  $\nu_a$ . The shear strength of the adhesive layer is  $\tau_{max}$  and the interfacial tensile strength at the top (end of embedment) of the adhesive core is  $\sigma_{max}$ . The coordinate system is that of Figure 5-66(b).

The proposed formulation for an adhesive anchor will be based on the following assumptions:

- During the deformation, the shear stress is dominant within the adhesive layer. It will not change the displacement in the  $r$  direction, so all the points in the same cylindrical surface in the adhesive layer will still keep in the same cylindrical surface.
- The concrete is much stiffer than the bulk adhesive materials, so the deformation of an anchor under a pullout load is mainly caused by the deformation of adhesive layer and the concrete is assumed to be rigid;
- When the adhesive anchor is in an appropriate service condition, the top of the anchor is bonded to the top of the concrete hole. When de-bonding occurs, the integrity of the anchor is destroyed. Therefore, the damage is determined by both the critical interfacial tensile strength at the top and the shear strength of the lateral adhesive layer.



Based on the assumption 1, we can write the displacement component  $u$  in the  $r$  direction (Yin et al., 2008b) as a

$$u(r, z) = 0. \quad (8)$$



Using Eq. (8), we can obtain the strain-displacement relation for this axisymmetric problem,

$$\varepsilon_{zz} = w_{,z}; \gamma_{zr} = w_{,r}; \text{ and } \varepsilon_{rr} = \varepsilon_{\theta\theta} = \gamma_{z\theta} = \gamma_{r\theta} = 0 \quad (9)$$



where  $u_{,z}$  is used. Using the constitutive law, we can write

$$\sigma_{zz} = \frac{E_a(1-\nu_a)}{(1+\nu_a)(1-2\nu_a)} \varepsilon_{zz} \quad (10)$$



$$\sigma_{rr} = \sigma_{\theta\theta} = \frac{E_a\nu_a}{(1+\nu_a)(1-2\nu_a)} \varepsilon_{zz} \quad (11)$$



and

$$\tau_{zr} = \frac{E_a}{2(1+\nu_a)} \gamma_{zr}; \tau_{z\theta} = \tau_{r\theta} = 0. \quad (12)$$



The equilibrium in the  $z$  direction can be written as

$$\sigma_{zz,z} + \tau_{zr,r} + \frac{\tau_{zr}}{r} = 0. \quad (13)$$



Substituting Eqs. (9) into (10) and (12), and then into Eq. (13), we can obtain

$$\frac{2(1-\nu_a)}{1-2\nu_a} w_{,zz} + w_{,rr} + \frac{w_{,r}}{r} = 0. \quad (14)$$



Using the method of separation of variables, we can write the displacement  $w$  in the following form as

$$w(r, z) = R(r)Z(z). \quad (15)$$



The substitution of Eq. (15) into Eq. (14) yields

$$-\frac{Z_{,zz}}{Z} = \frac{1-2\nu_a}{2(1-\nu_a)} \left( \frac{R_{,rr}}{R} + \frac{R_{,r}}{rR} \right) = c^2. \quad (16)$$



where  $c$  will be determined by boundary conditions. Then we obtain

$$Z_{,zz} + c^2 Z = 0. \quad (17)$$

and

 Equation

$$R_{,rr} + \frac{1}{r}R_{,r} - \frac{2(1-\nu_a)}{1-2\nu_a}c^2R = 0. \quad (18)$$

The general solution for Eq. (17) is written as

 Equation

$$Z = A\sin(cz) + B\cos(cz) \quad (19)$$

where  $A$  and  $B$  are to be determined by the boundary conditions as follows. Based on the assumption 2, at the top of the adhesive layer the displacement is zero, so we obtain

 Equation

$$B = 0 \quad (20)$$

At the bottom of the layer, the normal stress is zero, i.e.,

$$\sigma_{zz} \Big|_{z=L} = 0, \text{ or } Z_{,z} = 0. \quad (21)$$

Therefore, we obtain

 Equation

$$c_i = \frac{i\pi}{L} + \frac{\pi}{2L} \text{ with } i = 0, 1, 2, \dots, \quad (22)$$

so that a series form of solution for  $Z(z)$  is obtained as

 Equation

$$Z_i(z) = A_i \sin(c_i z). \quad (23)$$

The general solution for Eq. (18) can be written as

 Equation

$$R_i(r) = C_i I_0(d_i r) + D_i K_0(d_i r). \quad (24)$$

where  $I_0(d_i r)$  and  $K_0(d_i r)$  are the modified Bessel functions, and

 Equation

$$d_i = \sqrt{\frac{2(1-\nu_a)}{1-2\nu_a}} c_i. \quad (25)$$

Based on the assumption 2, along the inner lateral surface of the concrete hole, the displacement is zero, so we can write

 Equation

$$R \Big|_{r=b} = C_i I_0(d_i b) + D_i K_0(d_i b) = 0, \text{ or } C_i = -\frac{D_i K_0(d_i b)}{I_0(d_i b)}. \quad (26)$$

Therefore, the general solution in Eq. (15) can be written as

 Equation

$$w = \sum_{i=0}^{\infty} F_i \sin(c_i z) [K_0(d_i b) I_0(d_i r) - I_0(d_i b) K_0(d_i r)]. \quad (27)$$

If the coefficient  $F_i$  is determined, the solution can be obtained. Now there is another unused boundary condition at  $r = a$ , which is not explicitly given.

We can still consider the adhesive core as a 1D rod. The normal force will be balanced by the shear force, which is proportional to the displacement  $w$ . Therefore, Eq. (1) can be rewritten as

$$w_{zz} - \lambda^2 w = 0. \quad (28)$$

where  $\lambda$  depends on the effective shear stiffness of the adhesive layer. Notice that the above equation is applicable to the region  $r \leq a$ . Based on the assumption 3, we can write the boundary conditions

$$w = 0 \text{ for } z = 0. \quad (29)$$

and

$$E_c \pi a^2 w_z = P \text{ for } z = L. \quad (30)$$

Therefore, the solution of Eq. (28) can be written as

$$w = \frac{P}{E_c \pi a^2 \lambda} \frac{\sinh(\lambda z)}{\cosh(\lambda L)} \quad (31)$$

From the above equation, we can obtain normal stress at the top of the anchor as

$$\sigma_{zz} = \frac{P}{\pi a^2} \frac{1}{\cosh(\lambda L)} \leq \sigma_{max} \quad (32)$$

where  $\sigma_{max}$  is the interfacial tensile strength at the top of the anchor. When

$$P_c = \sigma_{max} \pi a^2 \cosh(\lambda L), \quad (33)$$

the anchor reaches its capacity and de-bonding may initiate at the top of the anchor. At this critical moment, the displacement in the adhesive core can be written as

$$w = \frac{\sigma_{max}}{E_c \lambda} \sinh(\lambda z). \quad (34)$$

Using Eq. (31), we can provide another boundary condition for Eq. (27) and then determine the coefficient  $F_i$  as

$$F_i = \frac{PL}{2E_c \pi a^2 \lambda \cosh(\lambda L) K_0(d_i b) I_0(d_i a) - I_0(d_i b) K_0(d_i a)} \int_0^L \sinh(\lambda z) \sin(c_i z) dz \quad (35)$$

 Equation

 Equation

 Equation

 Equation

 Equation

 Equation

 Equation

 Equation

Therefore, the displacement field is obtained in both the anchor as Eq. (31) and the adhesive layer as Eq. (27). Then the stress and strain can be obtained through Eqs. (9) – (12). Because  $\lambda$  in Eq. (28) depends on the effective shear stiffness of the adhesive layer, it will numerically determined by the force balance that the resultant shear force along the lateral surface is equal to the remaining tensile load, i.e.,

$$\sqrt{f} \text{ Equation } \quad - \int_0^L \frac{\pi a E_a}{1 + \nu_a} w_{,r} dz = P \left( 1 - \frac{1}{\cosh(\lambda L)} \right) \quad (36)$$

Although the series form solution may provide a higher accuracy of elastic stress and strain fields, a simplified closed form solution can be especially convenient and valuable for anchor design. Following, we only adopt the first term in the series form solution for simplification. In Eq. (22), let  $i = 0$ , i.e.,

$$\sqrt{f} \text{ Equation } \quad c_0 = \frac{\pi}{2L} \quad \text{and} \quad d_0 = \sqrt{\frac{1 - \nu_a}{2(1 - 2\nu_a)}} \frac{\pi}{L} \quad (37)$$

Eq. (27) can be simplified as

$$\sqrt{f} \text{ Equation } \quad w = F_0 \sin\left(\frac{\pi z}{2l}\right) [K_0(d_0 b) I_0(d_0 r) - I_0(d_0 b) K_0(d_0 r)]. \quad (38)$$

Due to the simplification of  $w$ , the displacement across the interface of the adhesive layer and the core at  $r = a$  cannot be continuous. However, we set the displacement at the bottom of the adhesive layer is equal to that of the core, and obtain

$$\sqrt{f} \text{ Equation } \quad F_0 = \frac{P \tanh(\lambda L)}{E_c \pi a^2 \lambda [K_0(d_0 b) I_0(d_0 a) - I_0(d_0 b) K_0(d_0 a)]} \quad (39)$$

To determine  $\lambda$ , we substitute Eq. (38) into Eq. (36) and obtain

$$\sqrt{f} \text{ Equation } \quad \frac{\lambda L}{2} \tanh\left(\frac{\lambda L}{2}\right) = \frac{E_a L^2 d_0 [K_0(d_0 b) I_1(d_0 a) + I_0(d_0 b) K_1(d_0 a)]}{E_c (1 + \nu_a) \pi a [I_0(d_0 b) K_0(d_0 a) - K_0(d_0 b) I_0(d_0 a)]} \quad (40)$$

If the right side of Eq. (40) is larger than 1, using  $\tanh\left(\frac{\lambda L}{2}\right) \cong 1$  we can estimate

$$\sqrt{f} \text{ Equation } \quad \lambda = \frac{2 E_a L d_0 [K_0(d_0 b) I_1(d_0 a) + I_0(d_0 b) K_1(d_0 a)]}{E_c (1 + \nu_a) \pi a [I_0(d_0 b) K_0(d_0 a) - K_0(d_0 b) I_0(d_0 a)]} \quad (41)$$

If the right side of Eq. (40) is much smaller than 1, using  $\tanh\left(\frac{\lambda L}{2}\right) \cong \frac{\lambda L}{2}$  we can approximately obtain

$$\sqrt{f} \text{ Equation } \quad \lambda = 2 \sqrt{\frac{E_a d_0 [K_0(d_0 b) I_1(d_0 a) + I_0(d_0 b) K_1(d_0 a)]}{E_c (1 + \nu_a) \pi a [I_0(d_0 b) K_0(d_0 a) - K_0(d_0 b) I_0(d_0 a)]}} \quad (42)$$

Otherwise, a numerical iteration algorithm is needed to calculate  $\lambda$ .

### 5.7.4 Results and discussion

To demonstrate the application of this model, adhesive anchors with a methylmethacrylate (MMA) bonded steel rods into concrete are considered (Colak, 2007). The material constants are:  $E_c = 210GPa$ ,  $E_a = 3.92GPa$ ,  $\nu_a = 0.4$ ,  $\tau_{max} = 6.2MPa$ , and  $\sigma_{max} = 15MPa$ . Only the simplified solution is used, i.e., only one term in the series form is considered.

First, the stress distribution for an anchor with  $a = 8mm$ ,  $b = 14mm$ , and  $L = 200mm$ : Eq. (41) is applicable and  $\lambda = 47.56 m^{-1}$ . When  $P = 1000N$  is applied, from Eq. (32), the tensile stress at the top of the rod is only 736Pa, which means that most tensile load is transferred through the lateral surface to the concrete. Figure 5-67 illustrates the shear stress distributions along  $r = a$  and  $b$ , i.e., the inner and outer surfaces of the adhesive layer. The shear stress in the thickness direction is not uniform: at the inner surface, the shear stress is significantly higher than that at the outer surface.

If the load keeps increasing, it is apparent that the shear stress at the bottom of the inner surface of the adhesive layer will first exceed the shear strength. The load capacity is found to be 40KN. At this point, lateral de-bonding will occur. Based on the existing uniform bond stress (UBS) model, we can obtain  $\lambda = 16.67 m^{-1}$  from Eq. (5). The shear stress is uniform in the thickness and can be calculated from Eq. (6) as 0.332MPa, which is higher than the result from the proposed model. It provides the load capacity as 19KN, which is significantly lower than the present prediction. Notice that in the application of UBS in the actual design (Cook, et al., 1993),  $\lambda$  needs to be calibrated with experiments so that the predicted load capacity will be different from the simplified prediction of 19 KN. Colak (2007) also observed the difference between the UBS prediction and the experimental results, and then introduced an adjustable parameter to fit  $\lambda$ .

Figure 5-68 compares the predictions of load capacity from the proposed model and the UBS model for different embedment depths  $L$  of anchor

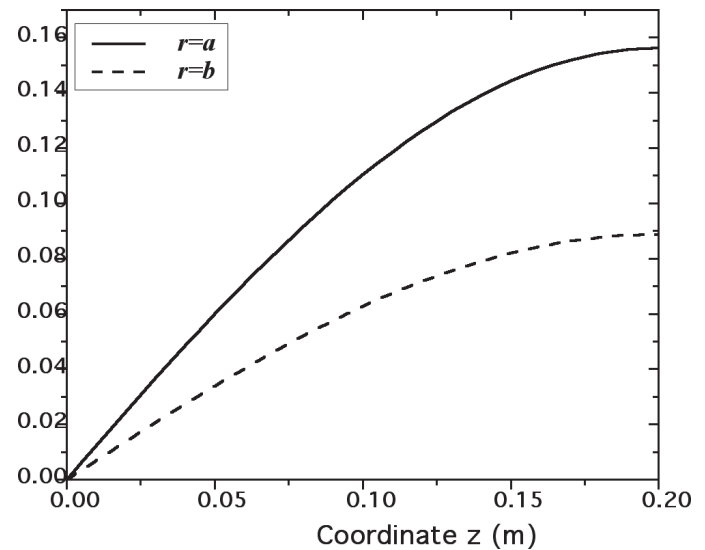

Figure 5-67: Shear stress distributions vs.  $z$  along the inner ( $r=a$ ) and outer ( $r=b$ ) surfaces

rod with  $a = 5\text{mm}$ , , and  $b = 6\text{mm}$  . Without any calibration, both models provide lower predictions than the experimental results. However, the proposed model provides a much closer prediction of the test results. With the increase of bond length, the load capacity considerably increases. However, the UBS model cannot capture this effect. Instead, its

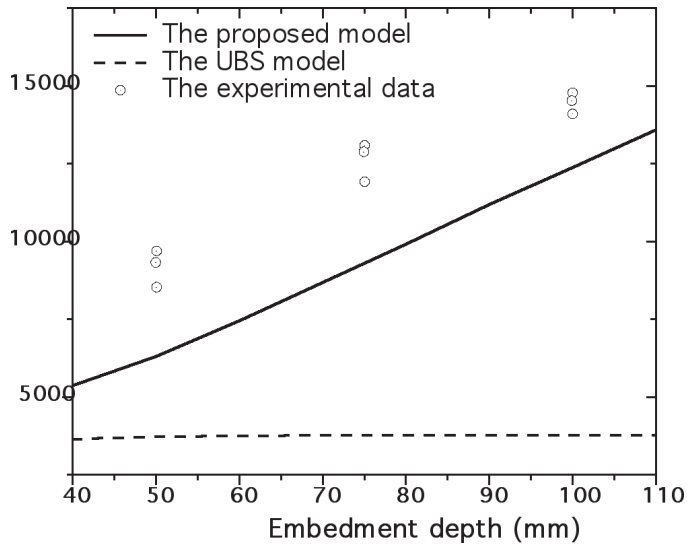

Figure 5-68:  
Effect of embedment depth on the load capacity of the anchor

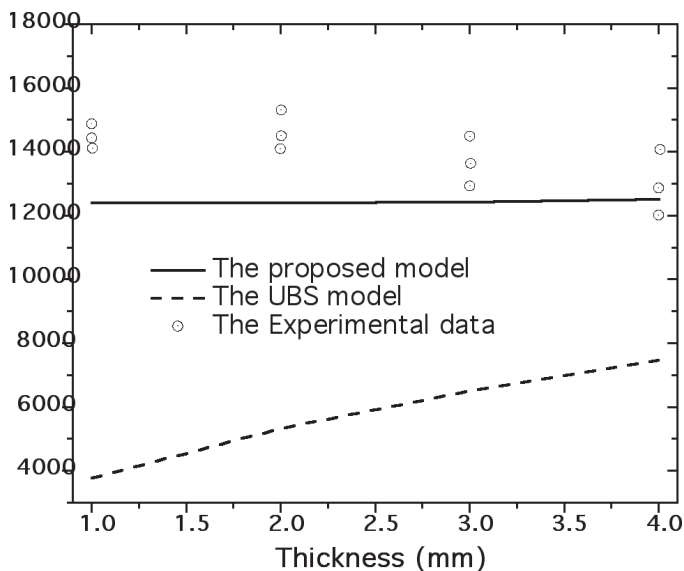

Figure 5-69:  
Effect of thickness of the adhesive layer on the load capacity of the anchor

of elastic analysis. In the actual design, the actual values should be used for different sizes of anchors.

prediction almost keeps constant with the increase of embedment depth. Therefore, the UBS model is not applicable to anchors with large embedment depth. Notice that because the proposed model is based on elastic material behavior, it is reasonable for it to provide a lower prediction due to the nonlinear inelastic material behavior when the load approaches to the load capacity during the tests.

Figure 5-69 compares the predictions of load capacity from the proposed model and the UBS model for different thickness  $t$  of adhesive layers with  $a = 5\text{mm}$  and  $L = 100\text{mm}$  . The thickness changes from 1 mm to 4 mm. In experiments, the load capacity decreases with the thickness of adhesive layers. Actually, it is also found that the shear strength of adhesive materials decreases with the thickness of adhesive layers as well. For simplicity, here we still use the constant shear strength. The proposed model provides almost constant prediction of the load capacity. When the embedment depth is not that long, the top de-bonding may be dominant, and then the load capacity will decrease along with the thickness. However, because the UBS model violates the force equilibrium in the thickness direction, it mistakenly predicts that load capacity increases along with the thickness.

Notice that the shear strength  $\tau_{max}$  and interfacial tensile strength  $\sigma_{max}$  may change with the dimensions and material types of the anchor components. The constant values used here are only for demonstration

The differences between the proposed model and UBS model can be summarized as follows:

- The proposed model captures the variation of shear stress along the thickness of adhesive layer; whereas the UBS model assumes it to be constant, which violates the force equilibrium principle.
- The proposed model determines the load capacity by the integrity of anchors, so both the top de-bonding and the lateral de-bonding are checked. However, the UBS model only considers the shear strength and disregards the load transfer at the top of the concrete hole.
- The proposed model considers axial symmetry rather than the very simplified 1D UBS model. Therefore, the present solution gives values in terms of fundamental material properties, whereas the UBS model requires some calibration tests.

However, the proposed model is still subject to some limitations: First, the model is based on elastic material assumption. However, the adhesive layer typically exhibits visco-elastic behavior (Yin et al., 2008a). It will affect the failure mechanisms in two respects: When the anchor is kept under a constant load, the shear stress relaxation will occur within the adhesive layer, so that a larger portion of load will be transferred to the top surface in tensile stress. If the tensile load is higher than the top interfacial adhesion strength, and the stress relaxation cannot be stabilized, i.e., adhesive layer behaves like a fluid and eventually top de-bonding will occur due to the increased tensile stress along the top interface. On the other hand, if the top interface is weak and the tensile load is transferred to the adhesive layer, the sustaining load will make the adhesive material keep deforming. The microstructure of the macromolecular network can be overly stretched. The anchor core may eventually lose its functionality because of either large deformation or mechanical failure. The clearly needed extension of this work to consider visco-elastic behavior of adhesive materials is underway.

Secondly, the simplified model does not consider the deformation of the concrete base material. Some adhesive anchor failures are caused by the concrete material failure, and this may become more important for aging and deteriorated structures. Full scale simulation/modeling of an adhesive anchor is valuable and needed to provide some insights on concrete cone failure, concrete-adhesive interfacial de-bonding, and failure of anchor core.

In addition, this model assumed constant material properties for each material. However, in applications, the material properties change with time due to aging effects and with location due to moisture and

temperature effects and also aging effects. To accurately predict the long-term performance of adhesive anchor system, further research in both materials and mechanics is needed. Especially, failures of adhesive anchors may be caused by several factors in a progressive manner. An accurate model is a most important need for structure health determination and restoration.

### 5.7.5 Conclusions

A series form solution has been derived for an axisymmetric problem considering an anchor bonded into a concrete hole with an adhesive layer. Using some approximations, a closed form elastic solution is obtained. The relation to the uniform bond stress model is discussed. The formulation and numerical results reveal that the existing design method, based on 1D approximation, violates the force equilibrium principle and may produce unreasonable and unsafe predictions of the load capacity of the adhesive anchor system. Without any calibration, the proposed model produces much better predictions of the load capacity compared with some experimental results. The elastic formulation presented here is the first step in developing a more realistic time dependent model for these anchor systems whose role can be vital in sustaining and restoring aging infrastructure as well as in new construction. Extension of the present model to include the visco-elastic behavior of adhesives is underway.

### 5.7.6 Acknowledgements

The author acknowledges the financial support from the University Transportation Research Center (UTRC). The results and opinions presented herein are those of the author and do not necessarily reflect those of the sponsoring agency.

### 5.7.7 References

- ACI Committee 503, (1992). Guide for the selection of polymer adhesives with concrete. *ACI Materials Journal* 89, 90-105.
- Colak, A. (2001). Parametric Study of Factors Affecting the Pull-out Strength of Steel Rods Bonded into Precast Concrete Panels. *International Journal of Adhesion and Adhesives* , 21, 487-493.
- Colak, A. (2007). Estimation of ultimate tension load of methylmethacrylate bonded steel. *International Journal of Adhesion & Adhesives* 27, 653-660.



Cook, R., & Konz, R. (2001). Factors Influencing Bond Strength of Adhesive Anchors. *ACI Structural Journal* , 98, 76-86.

Cook, R., Doerr, G., & Klingner, R. (1993). Bond stress model for design of adhesive anchors. *ACI Structural Journal* , 90, 514-524.

Cook, R., Kunz, J., Fuchs, W., & Konz, R. (1998). Behavior and Design of Single Adhesive Anchors under Tensile Load in Uncracked Concrete. *ACI Structural Journal* , 95, 9-26.

Doerr, R., & Klingner, R. (1989). Adhesive anchors: load-deflection behavior and spacing requirements. University of Texas at Austin: Center for Transportation Research.

Eligehausen, R., Cook, R., & Appl, J. (2006). Behavior and Design of Adhesive Bonded Anchors. *ACI Structural Journal* , 103, 822-831.

Ferry, J. (1980). *Visco-elastic properties of polymers* (3rd ed.). New York: Wiley.

ICC. (1995). Acceptance criteria for adhesive anchors in masonry elements. ICC Evaluation Service, Inc.

McVay, M., Cook, R., & Krishnamurthy, K. (1996). Pullout simulation of post installed chemically bonded anchors. *Journal of Structure Engineering*, 122, 1016-1024.

NTSB. (2007). Highway accident report: ceiling collapse in the Interstate 90 connector tunnel at Boston, MA, July 10, 2006. Washington, D.C.: National Transportation Safety Board.

Yin, H., Buttlar, W., Paulino, G., & Di Benedetto, H. (2008a). Assessment of existing micromechanical models for asphalt mastics considering visco-elastic effects. *Road Materials and Pavement Design* , 9, 31-57.

Yin, H., Paulino, G., & Buttlar, W. (2008b). An explicit elastic solution for a brittle film with periodic cracks. *International Journal of Fracture*, 153, 39-52.

## 5.8 A Stochastic Diagnostic Model for Subway Stations

*Nabil Semaan<sup>16</sup> and Tarek Zayed<sup>17</sup>*

### 5.8.1 Introduction

The goals of every subway transit authority are to augment the level of reliability, public safety, and achieve a better level of service. The goal behind these goals is to attract more users and to ensure their safety. The ‘Société de Transport de Montréal’ (STM) has estimated the replacement value of its network at 4.6 CAD Billion in 2002, out of which 2.6 (56.5%) CAD Billion are assigned solely to stations. Therefore, stations represent a major section of any subway transit network. A significant number of subway stations are aging and hence

surpassing their functional life. If stations are showing serious deterioration, they become unsafe to the public. The major problem that faces STM and most transit authorities is the lack of proper rehabilitation planning for their stations. This includes setting priorities, budget allocation, investment plans, and financing. The lack of proper rehabilitation planning is directly linked to the lack of assessment tools of stations’ performance. Previous research in this field has provided ranking

methods for the stations, prioritizing stations for rehabilitation but these methods fail to provide condition index (level of deterioration) to each station. Therefore, there is an urgent need to develop an index in order to diagnose the condition of subway stations and rank them according to a well-defined condition scale. A deterministic subway station condition assessment model was developed by Semaan (2006), entitled ‘Subway Station Diagnosis Index’ SSDI. This model uses specific data for its input, chiefly the criteria weights, criteria Tolerance Thresholds (TT), and the criteria Critical Thresholds (CT). These data were collected through questionnaires sent to transit authorities’ engineers and managers. The SSDI model inputs – in addition to the inspection scale of the criteria – use the average values of the criteria weights, CT and TT. Although the deterministic model generates satisfactory results, yet it fails to consider the uncertainties inherited in the problem parameters



The goals of every subway transit authority are to augment the level of reliability, public safety, and achieve a better level of service.

<sup>16</sup> Ph.D. student, Building, Civil, and Environmental Engineering department, Concordia University, Montreal, Quebec, Canada, H3G 1M7.

<sup>17</sup> Associate Professor, Building, Civil, and Environmental Engineering department, Concordia University, Montreal, Quebec, Canada, H3G 1M7.

and collected data. Therefore, these uncertainties should be considered using probabilistic modeling.

The objective of the research presented in this paper is to develop a stochastic performance model for subway stations: the stochastic Global Station Diagnosis Model (GSDM). The new developed model considers the uncertainties in the problem parameters and collected data. It has a key role in managing maintenance and repair activities for subway stations. It is developed in such a manner that it is easy and fast to implement.

### 5.8.2 Background

Although metro stations in major cities worldwide are aging, a unified performance model has not yet been developed (Semaan 2006). Each transit authority, depending on its need, developed preliminary rating methods according to their own management plans. The California (Cal) Train transit system, inaugurated in 1864, is one of the oldest systems in the United States. In the 1990's Cal Train had set objectives to improve its stations and thus initiate the station planning process. In 1994, Cal train has developed a specific system for the evaluation of stations and ranking from *excellent to poor*: (1) Excellent; (2) Good; (3) Average; (4) Below average; (5) Poor. The criteria used for the evaluation of the stations are: i) Ease of access to and from the station, ii) location of the station and proximity to amenities, iii) availability of parking capacities, iv) ability to use other modes of transportation, v) appearance and cleanliness of the stations, vi) physical and structural performance of the stations, vii) public information, signs, telephones, viii) ticket vending machines, ix) security, and x) safety. The evaluation method adopted was a weighted average of the criteria values (Abu-Mallouh, 2001).

In 1990, London Transit's main objective was to improve its system. It developed the Key Performance Indicator (KPI), which evaluates the performance of the station from the point of view of its customers (Tolliver, 1990). Surveys and interviews were performed in order to obtain a direct evaluation of customer satisfaction. Customers were asked to rate 23 items on a scale from 0 to 10, based on the following criteria: i) Cleanliness, ii) information services, iii) information on trains, i.e.,



Performance of subway stations is a critical problem that faces public transit authorities worldwide. Although replacing subway stations is costly, the Société de Transport de Montréal (STM) and most transit authorities lack planning strategies because performance models do not exist. The research presented in this paper assisted in developing a stochastic Global Station Diagnosis Model (GSDM). The GSDM identifies and evaluates the weights of different functional condition criteria for subway stations. It also utilizes the Preference Ranking Organization Method of Enrichment Evaluation (PROMETHEE) integrated with the Multi-Attribute Utility Theory (MAUT) and Monte Carlo simulation in order to determine a stochastic Global Diagnosis Index (GDI). Data were collected from experts through questionnaires and interviews. A case study from the STM subway station network was selected to implement the designed model. Results show that the GDI ranges from 5.6 to 7.8 with a 95% confidence.

**INFRASTRUCTURE TYPE:** Subway stations

station services (ticket gates, ease of access to platforms, buying a ticket and the degree of platform crowding, iv) safety and security, v) train services (crowding, journey time, smoothness of the ride...), and vi) staff helpfulness and availability. The KPI is calculated as an overall weighted average of the 23 measures of evaluation (Abu-Mallouh, 2001).

A deterministic Subway Station Diagnosis Index (SSDI) model was developed in order to diagnose the functional performance of subway stations (Semaan, 2006; Semaan and Zayed, 2008). The SSDI model is developed based on two of the *Multi-Criteria Decision Analysis* (MCDA) methods. The SSDI model is used to diagnose a specific subway station and assess its condition using an index (0 to 10). Based on the SSDI, the condition scale describes the station's condition state, its deterioration level (%), and the proposed consequent actions as illustrated in Table 5-27 (Semaan 2006).

### 5.8.3 Sources Of Uncertainty In The SsdI Model

Two main sources of uncertainties in the deterministic SSDI model exist, the criteria weights and thresholds. The weights of criteria are subjective in nature and depend on the decision maker's opinion. This subjectivity

Two main sources of uncertainties in the deterministic SSDI model exist, the criteria weights and thresholds.

generates uncertainty when decision makers evaluate these weights. On the other hand, the Critical Threshold (CT) and the Tolerance Threshold (TT) are two new concepts that are introduced to the field of infrastructure asset management (Semaan 2006). Thus, assigning values to these thresholds is one of the most difficult tasks for transit engineers. A structural engineer/designer can probably have a better estimate of the structural Critical Threshold

since he/she has a background in designing structural elements. While, it is very difficult for a mechanical engineer to assign a structural CT, although it is not impossible since he/she has maintenance and repair (M&R) experience. Hence, the method of assigning CT and TT for the criteria contains much uncertainties, errors, and lack of knowledge.

Thus, the sources of uncertainties in weights, CT, and TT could be as follow:

- Lack of clear specification, or characteristic of what is required.
- Lack of experience in evaluating the required criteria.
- Complexity in terms of the number of influencing factors and interdependencies among these factors. For example, for the structural CT and TT, the factors may include: corrosion rate, loading, fatigue,

moment capacity, shear capacity, materials factors of safety, loading factors of safety, concrete compressive strength, steel reinforcement yield stress, construction errors, etc.

- Limited analysis of the factors involved in this problem.
- Possible occurrence of particular events or conditions that could have some uncertain effect on the data assignment.
- Lack of understanding of what is involved.
- Subjective judgment of decision maker.

## 5.8.4 Stochastic Global Station Diagnosis Model (Gsdm)

### 5.8.4.1 The GSDM Methodology

Figure 5-70 illustrates the methodology of developing the stochastic Global Station Diagnosis Model (GSDM). The Global Station Diagnosis Model (GSDM) identifies and defines the different functional condition criteria, sets a hierarchy of the criteria, and then evaluates the weights of the criteria using the Analytical Hierarchy Process (Saaty, 1980). It also utilizes the Preference Ranking Organization Method of Enrichment Evaluation (PROMETHEE) (Brans et al., 1986) in order to aggregate the criteria, i.e., determine a multi-criteria preference index. Then it integrates the Multi-Attribute Utility Theory (MAUT) (Keeny and Raiffa, 1976) and Monte Carlo simulation in order to determine the stochastic Global Diagnosis Index GDI. Monte Carlo simulation is utilized in order to develop the GSDM considering CT, TT, and weights as random variables. The details of the stochastic model development are depicted in the following sections.

### 5.8.4.2 Criteria Definition

The GSDM criteria definitions, shown in Table 5-28, are as follows:

- Structural/Architectural function: (C1) Global structure, (C2) global architecture, and (C3) concrete stairs.
- Mechanical function: (C4) Mechanical stairs, (C5) pipes and mechanical equipments, (C6) ventilation system, and (C7) fire stand pipes.
- Electrical function: (C8) lighting, (C9) electric wires, and (C10) panels, transformers and breakers.
- Communication/Security function: (C11) Alarm, smoke detectors, and (C12) communication system (telemetry).

### 5.8.4.3 Criteria Weights

The criteria weights are evaluated using the AHP method. Considering the various weights of criteria that are generated using different experts, a population of weights for each criterion is developed. However, the sum of criteria weights  $f(W_{fj})$  shall equal one as shown in Equation (1):

 Equation

$$\sum_{j=1}^4 f(W_{fj}) = 1.0 \quad (1)$$

Where  $f(W_{fj})$  = the random variable of the cumulative distribution function of  $W_{fj}$

The sum of sub-criteria weights  $f(W_{ci})$  shall also be equal to one, as shown in Equation (2):

 Equation

$$\sum_{i=1}^n f(W_{ci}) = 1.0 \quad (2)$$

Where  $C_i$  = sub-criteria,  $i$  = to 12

$f(W_{ci})$  = the random variable of the cumulative distribution function of  $W_{ci}$

Therefore, the global weight  $f(W_{gi})$  of the criteria can be defined in Equation (3):

 Equation

$$f(W_{gi}) = f(W_{ci}) \cdot f(W_{fj}) \quad (3)$$

Where  $f(W_{gi})$  = global random variable of the cumulative distribution function of weight of sub-criterion  $C_i$

### 5.8.4.4 Multi-Criteria Aggregation

The multi-criteria aggregation is performed using the PROMETHEE method (Semaan, 2006). First of all, GSDM defines the Critical Threshold (CT) and the Tolerance Threshold. The Critical Threshold (CT) is the threshold beyond which a criterion is considered dangerous (or critical), whereas the Tolerance Threshold (TT) is the threshold below which a criterion is considered not dangerous at all (or tolerable). The Critical and Tolerance Thresholds (CT, TT) are represented by probability density functions. Hence,  $f(CT)$  would be the random variable of CT, and similarly  $f(TT)$  would be the random variable of TT. The definition of  $f(CT)$  and  $f(TT)$  is illustrated in Figure 5-71.

Second, GSDM compares every value of a criterion, taken from an inspection report, with the TT and CT. This is performed using Monte Carlo simulation. The Monte Carlo simulation starts with generating a random number, then, reads from the cumulative distribution functions of  $f(CT)$

and  $f(TT)$ , which compared with the value of the criterion  $V[C(S)]$  in a Generalized Preference Function (GPF), gives a probability distribution function of the Preference Index  $f(P)$  as shown in Figure 5-72. In a mathematical form, Equation (4) illustrates the mathematical definition of the GSDM Generalized Preference Function (GPF):

$$\left. \begin{cases} 0 & \text{if } V [C_i(S)] < f(TT) \\ 1 & \text{if } V [C_i(S)] > f(CT) \\ (V_i [C_i(S)] - f(TT) / (f(CT)-f(TT)) \text{ if } f(TT) \leq V [C_i(S)] \leq f(CT) \end{cases} \right\} \text{t) } \sqrt{f} \text{ Equation}$$

Where,

$i = 1$  to  $n$ ;  $n =$  total No. of sub- criteria;

$S =$  any given Station;

$f\{P[V(C)]\} =$  Sub-Criteria preferences random variate of the cumulative distribution function.

Then, starting from a single criterion preference index  $P[V]$ , PROMETHEE with Monte Carlo simulation evaluates a multi-criteria preference index. The multi-criteria preference index is defined as a probability distribution function  $P[S]$  as shown in Equation (5):

$$\left. \begin{cases} f(\Pi [S_k, S_0]) = \sum_{i=1}^n f(W_{ci}) \cdot f(P_i (S_k, S_0)) \\ f(\Pi [S_{100}, S_k]) = \sum_{i=1}^n f(W_{ci}) \cdot f(P_i (S_{100}, S_k)) \\ f(\Pi [S_{100}, S_0]) = \sum_{i=1}^n f(W_{ci}) \cdot f(P_i (S_{100}, S_0)) = 1 \end{cases} \right\} \text{(5) } \sqrt{f} \text{ Equation}$$

Where  $S_k =$  given station under study,

$S_0 =$  fictitious station that has all the criteria values as Zeros (0).

$S_{100} =$  fictitious station that has all the criteria values as Hundreds (100).

#### 5.8.4.5 Station Outranking

Using the multi-criteria preference index probability function, a stochastic station outranking is performed. The outranking is done using two measures, the strength and weakness of the station  $S_k$ .

The measure of strength of  $S_k$  is defined in Equation (6):

 Equation

$$f(\Phi^-(S_k)) = f(P[S_k, S_0]) + f(P[S_k, S_{100}]) + f(P[S_k, S_k]) \quad (6)$$

The measure of weakness of  $S_k$  is defined in Equation (7):

 Equation

$$f(\Phi^-(S_k)) = f(\Pi[S_0, S_k]) + f(\Pi[S_k, S_k]) + f(\Pi[S_{100}, S_k]) \quad (7)$$

The Net Flow is defined as the difference between the strength and weakness measures, as shown in Equation (8):

 Equation

$$f(\Phi^{\text{net}}(S_k)) = f(\Phi^+(S_k)) - f(\Phi^-(S_k)) \quad (8)$$

Stations can be ranked using the Net Flow. This ranking is not until now a cardinal index, but it can be utilized as an attribute of the station. Furthermore, the Net Flow can be calculated separately for every function in the station, i.e., a separate Net Flow for structural, mechanical, electrical and communications respectively.

### 5.8.5 SFI and GDI Development

The GSDM evaluates a Stochastic Functional Index (SFI) from the separate functional Net Flows using both the Multi-Attribute Utility Theory (MAUT) and Monte Carlo Simulation. The SFI measures a cardinal condition index for every function in a subway station.

The SFI is defined as a probability density function as shown in Equation (9):

 Equation

$$f(\text{SFI}(S_k)) = -5 \cdot f(\Phi^{\text{net}}(S_k)) + 5 \quad (9)$$

From the SFI, a stochastic Global Diagnosis Index (GDI) is evaluated, using the multiplicative form of MAUT and Monte Carlo simulation as well. The GDI is a probability distribution function as shown in Equation (10):

 Equation

$$f(\text{GDI}) = \prod_{j=1}^4 f(\text{SFI}_j \cdot f(W_{fj})) \quad (10)$$

Where  $j$  = Function



### 5.8.6 Data Collection

Data for the GSDM model were divided into two types. The first type comprised the AHP pair-wise matrices, which were used to calculate the criteria weights. And the second one included the criteria thresholds (CT and TT). Data were collected through questionnaires, interviews, inspection reports, and Maintenance and Repair (M&R) planning reports. The questionnaires targeted the subway stations practitioners (engineers, inspectors, and management). The inspection reports were provided by the STM rehabilitation team (engineering unit) and the M&R reports were provided by the STM planning unit. Each category of data was analyzed separately. A questionnaire was developed and distributed to engineers. Forty questionnaires were sent to the STM and ten for each of the New York City Transit (NYCT), Massachusetts Bay Transit Authority (MBTA), California Train Authority (Cal Train) and Chicago Transit Authority (GTA). In addition, questionnaires were sent to engineers directly linked to the inspection of subway stations in Montreal (STM provided the names). Only 24 questionnaires were received, 16 from the STM and engineers linked STM, 4 from NYCT, and 4 from MBTA.

BESTFIT software was used to fit the probability distribution of the criteria weights, the Critical Thresholds (CT), and the Tolerance Threshold (TT). The normal distribution was found amongst the best fitted distribution for most variables. Table 3 summarizes the statistical information of the normal distribution for criteria weights. The Chi-Sq test is used to check whether the fitted distributions are statistically sound. The normal distribution proved its robustness in representing the collected data.

#### 5.8.6.1 SDM Application To STM

The developed Global Station Diagnosis Model (GSDM) is applied to real stations in order to prove its concept and functionality. The STM has provided inspection reports for 7 out of the 24 oldest stations, which were built in the 1960s. The twenty four stations that comprise the Montreal metro system are:

- |                    |                    |                     |
|--------------------|--------------------|---------------------|
| 1. At Water        | 2. Frontenac       | 3. Rosemont         |
| 4. Guy-Concordia   | 5. Bonaventure     | 6. Beaubien         |
| 7. Peel            | 8. Square-Victoria | 9. Jarry            |
| 10. McGill         | 11. Place D'Armes  | 12. Cremazie        |
| 13. Place des Arts | 14. Champs de Mars | 15. Sauve           |
| 16. St. Laurent    | 17. Sherbrooke     | 18. Henri- Bourassa |
| 19. Beaudry        | 20. Mont-Royal     | 21- Jean-Drapeau    |
| 22. Papineau       | 23. Laurier        | 24. Longeuil        |

Due to confidentiality, the STM did not permit identifying the seven stations; hence, arbitrary names, i.e., S1 to S7, were assigned to these real stations. It should be noted that only the names are symbolic; however, the values used for the criteria performance are taken from the inspection reports of these stations (Semaan 2006).

The first step in GSDM is to identify the criteria and sub-criteria as shown in Table 5-28. The inspection reports provided assessment of structural, architectural, mechanical, and electrical conditions. The remaining criteria (communication and security) were taken from the ‘Réno-Systèmes’ report (Semaan 2006). The values related to criteria performance were taken directly from the inspection reports, except for the ‘mechanical stairs’ sub-criterion, and the communication/security criteria. The latter were taken from the ‘Réno-Système’ program report. This report specifies that, for all STM stations, mechanical stairs, security system, control system and communication system are labeled as in ‘Bad’ performance, and thus require ‘short-term’ intervention. The values of performance criteria for C4, C11, and C12 are assigned the scale of 2 as described in the ‘Réno-Système’ report. The inspection reports assess the performance of different elements using a field inspection scale, and then assign a global scale for some functions, such as architectural or structural only. Table 5-30 shows the criteria values for the seven stations.

#### 5.8.6.2 The GSDM Application

The hierarchical structure of the criteria allows the GSDM to use AHP for evaluating the weights of criteria/sub-criteria. The probability distributions of weights utilized in the GSDM are developed based upon the collected data from experts as depicted in the data collection section. Also, the probability distribution functions of both CT and TT are used in the GSDM as input variables. Based on the above-mentioned values provided from BESTFIT for the criteria weights, CT, and TT, the @RISK-4.5 software is used to run Monte Carlo simulation. Simulation generates the GDI value as a probability distribution. The developed GSDM methodology is applied to the seven stations, i.e., S1 to S7. As an example, the simulation results for station S1 are shown in Figure 5-76. This figure illustrates the probability distribution, histogram, and cumulative distribution of GDI values.

#### 5.8.6.3 Analysis of Results

The GSDM considers the uncertainties inherent in the SSDI model’s criteria/sub-criteria. Table 5-31 shows the statistical output of the stochastic GDI for the S1. Due to shortage of space in this paper, the rest of the stations are not shown. The percentile values shown in the Table 5-31 correspond to the cumulative distribution values of the output. For

example, the 50% value of 5.6 for S1 means that there is 50% chance the stochastic GDI value for S1 is 5.6. In other words, the GDI equals to 5.6 for a 50% probability. Thus, for a 95% probability, the stochastic GDI values are 5.6, 7.8, 6.0, 5.7, 6.3, 6.3, and 6.3 for S1 to S7, respectively. Hence, for a 95% probability, the STM stations are either ‘Deficient’ (i.e., S1 and S4) or ‘Medium’ for S2, S3, S5, S6, and S7. This type of analysis confirms that the GDI output considers the uncertainties inherited in the input parameters. Table 5-32 shows the output results from the application of the deterministic SSDI model (Semaan, 2006). It is noted from Table 5-32 that the stations are found ‘Deficient’, which is matching (to a certain minimal difference) the mean value of the stochastic GDI values. Figure 5-77 shows the plot of the difference between deterministic SDI and stochastic GDI values.

Furthermore, since the output of the GSDM is probabilistic, no single value of the stochastic GDI is determined, i.e., it is a probability distribution. The choice of the stochastic GDI value depends on the level of confidence of the decision maker. It has been observed that the stochastic GDI output follows a normal distribution. Hence, three levels of confidence can be attributed to a normal distribution, the 68% (or 70% in some references), 95%, and 99%. For a 68% level of confidence, the range of the GDI lies between the mean value  $m \pm$  the standard deviation  $s$ . While for a 95% confidence level the range of GDI lies between  $m \pm 2s$ . Similarly, for a 99% confidence level the range of GDI lies between  $m \pm 3s$ . Thus, no single value can be obtained from the GSDM output, but a range of values depending on the decision maker level of confidence. Figure 5-78 illustrates the range of values of the stochastic GDI for a 68% and 95% confidence levels. Therefore, the stochastic GDI value can be read either depending on the probability from the cumulative distribution function, or taken as a range of values depending on the confidence levels.

#### 5.8.6.4 Sensitivity Analysis

Sensitivity analysis is the next step in the GSDM analysis in order to see how the variation of input changes the GSDM result, to what degree, and which input is most effective to the results. The sensitivity analysis using @RISK simulation — which identifies significant inputs — is carried out with two different analytical techniques. The first technique utilized regression analysis in which a sampled input variable values is regressed against output values, leading to the measurement of sensitivity of input variables. The second technique utilized a rank correlation analysis. With this analysis, correlation coefficients are calculated between the output values and each set of sampled input values. The results of each form of sensitivity analysis can be displayed on a “tornado” type chart, with longer

bars at the top representing the most significant input variables. Figure 5-79 illustrates the “tornado graphs” of the sensitivity analysis from the @RISK Monte Carlo simulation for S1 station. It is clear from this figure that the ‘Alarm/Security’ criterion is the most important one where it is the most effective criterion to GSDM. The next in rank is the ‘Global Structure’ criterion. Another observation is that the GSDM is mostly affected by the weights of criteria. Hence, the AHP must be used with care, since the AHP decision method carries many areas of uncertainties.

### 5.8.7 Conclusions

A new stochastic model for diagnosing the performance of subway stations is developed, the Global Station Diagnosis Model GSDM. This model considers the uncertainties inherited in the input variables, mainly the criteria weights, Tolerance Thresholds, and Critical Thresholds. The input and output variables follow a normal probability distribution function. The stochastic GDI values lie in the range of 2.0 to 8.0 for a 95% confidence level and between 3.0 and 6.8 for a 68% confidence level. The sensitivity analysis shows that the criteria weights mostly affect the stochastic GDI values. The ‘Alarm/Security’ is the most sensitive criteria to the GSDM results. The wide range of the GDI values for a 95% confidence level, mean that more data are required. The GSDM has more advantages over the deterministic model, since it takes into account the errors, uncertainties, inconsistencies, and lack of knowledge in the input criteria, which makes the GSDM closer to real life.

### 5.8.8 References

- Abu-Mallouh M. (1999). *Model for Station Rehabilitation and Planning* (MSRP). PhD Thesis, Construction Eng. and Mgmt Department, Civil Eng, Polytechnic University, NY.
- Al-Barqawi H. and Zayed T. (2006) “Condition Rating for Underground Infrastructure Sustainable Water Mains” *Journal of Performance of Constructed Facilities*, ASCE, 20(2), pp. 126-135.
- Banks J. Carson II J.S. Nelson B.L. Nicol D. M. (2001) *Discrete-Event System Simulation*, 3rd Ed., Prentice Hall International Series in Industrial and Systems Engineering, W.J. Fabrycky and J.H. Mize Editors, Prentice Hall, Upper Saddle River, NJ 07458, USA.
- Brans J.P. Mareschal B. and Vincke P. (1986) “How to select and how to rank projects: the PROMETHEE method” *European journal of Operational Research*, Vol. 24, pp. 228-238.

Halpin D. and Riggs L. (1992) *Planning and analysis of Construction Operations*. John Wiley and sons, NY, USA.

Keeney R.L., and Raiffa H., (1976), *Decision with Multiple Objectives: Preferences and Value Tradeoffs*, John Wiley and Sons, N.Y., USA.

Metropolis, N. and Ulam, S., (1949). "The Monte Carlo Method," *J. Amer. Stat. Assoc.* 44, 335-341.

Palisade (2000) *@Risk Analysis Add-In for Microsoft Excel 4.0.5* (Student Version).

Paul Coddington. "Monte Carlo Simulation for Statistical Physics." Northeast Parallel Architectures Center at Syracuse University

Saaty T., (1980), *The Analytical Hierarchy Process*, McGraw Hill, New York, USA.

Semaan N. (2006) *Subway Station Diagnosis Index (SSDI): A Condition Assessment Model*, Master Thesis, Concordia University, Building, Civil and Environmental Engineering Department, Construction Management Program, Montreal, Canada.

Semaan N. and Zayed T. (2008) "An Infrastructure Condition Assessment Model," Proceedings of the Canadian Society of Civil Engineering Conference, CSCE, Quebec city, Canada, June 10-13.

Société de Transport de Montréal, Bureau de projets Réno-Stations (2005) "*Programme de Maintien des Stations Réno-Stations II*," Rapport Justificatif, Synthèse, Décembre.

Société de Transport de Montréal, Bureau de projets Réno-Système (2004) "*Programme de Maintien du Patrimoine des équipements fixes du métro Réno-Système*," Rapport Justificatif, Synthèse, Juillet.

Tolliver Heidi, (1996), *A Tail of Four Cities*, 'Transit Operation Massachusetts Transit', pp. 22-74, Boston, USA.

Zayed T. and Halpin D. (2004) "Quantitative Assessment for Piles Productivity Factors," *Journal of Construction Engineering and Management*, ASCE, 130(3), pp. 405-414.

Figure 5-70:  
The GSDM Methodology

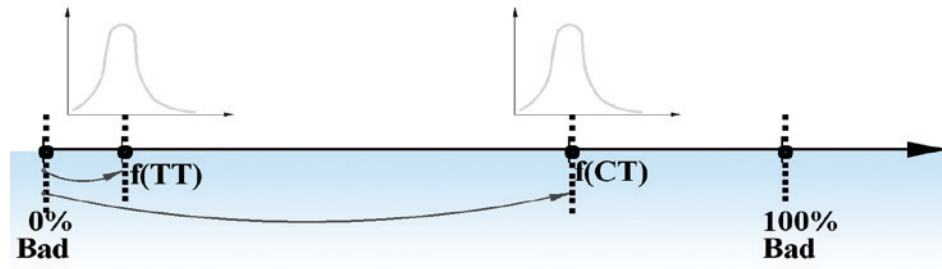

Figure 5-72:  
The GSDM GPF

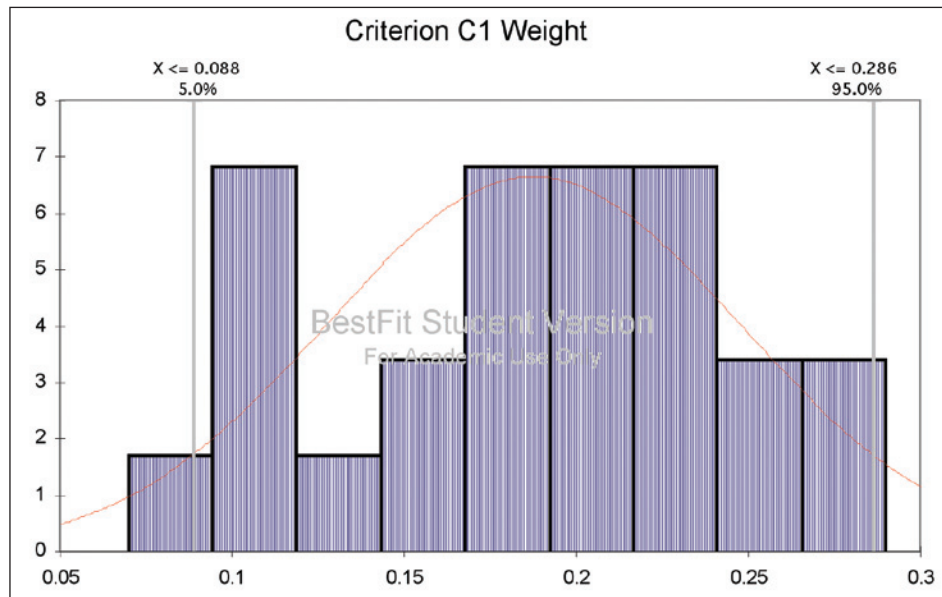
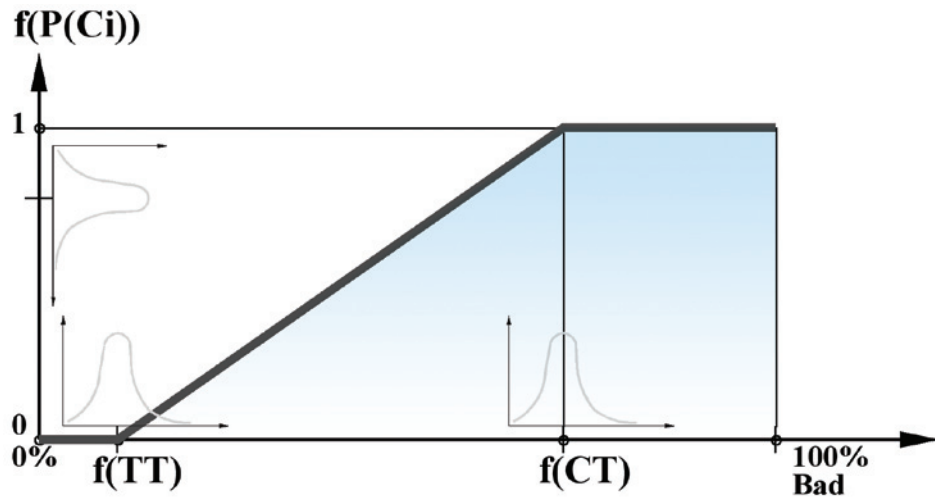

Figure 5-73: Criterion C1 Weight Histogram and Probability Distribution Function

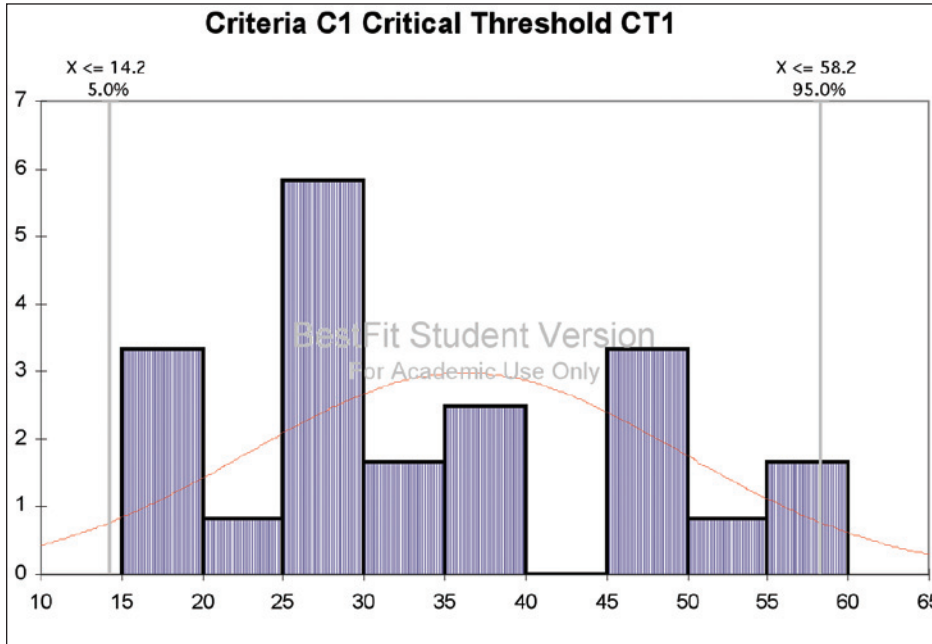

Figure 5-74: Criterion C1 Critical Threshold CT1 Histogram & Probability Distribution Function

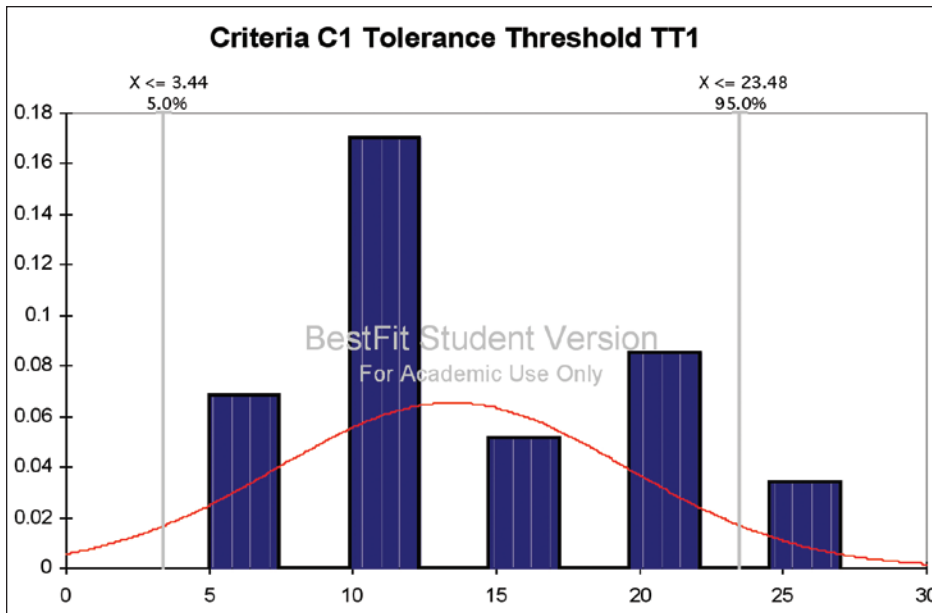

Figure 5-75: Criterion C1 Tolerance Threshold TT1 Histogram & Probability Distribution Function

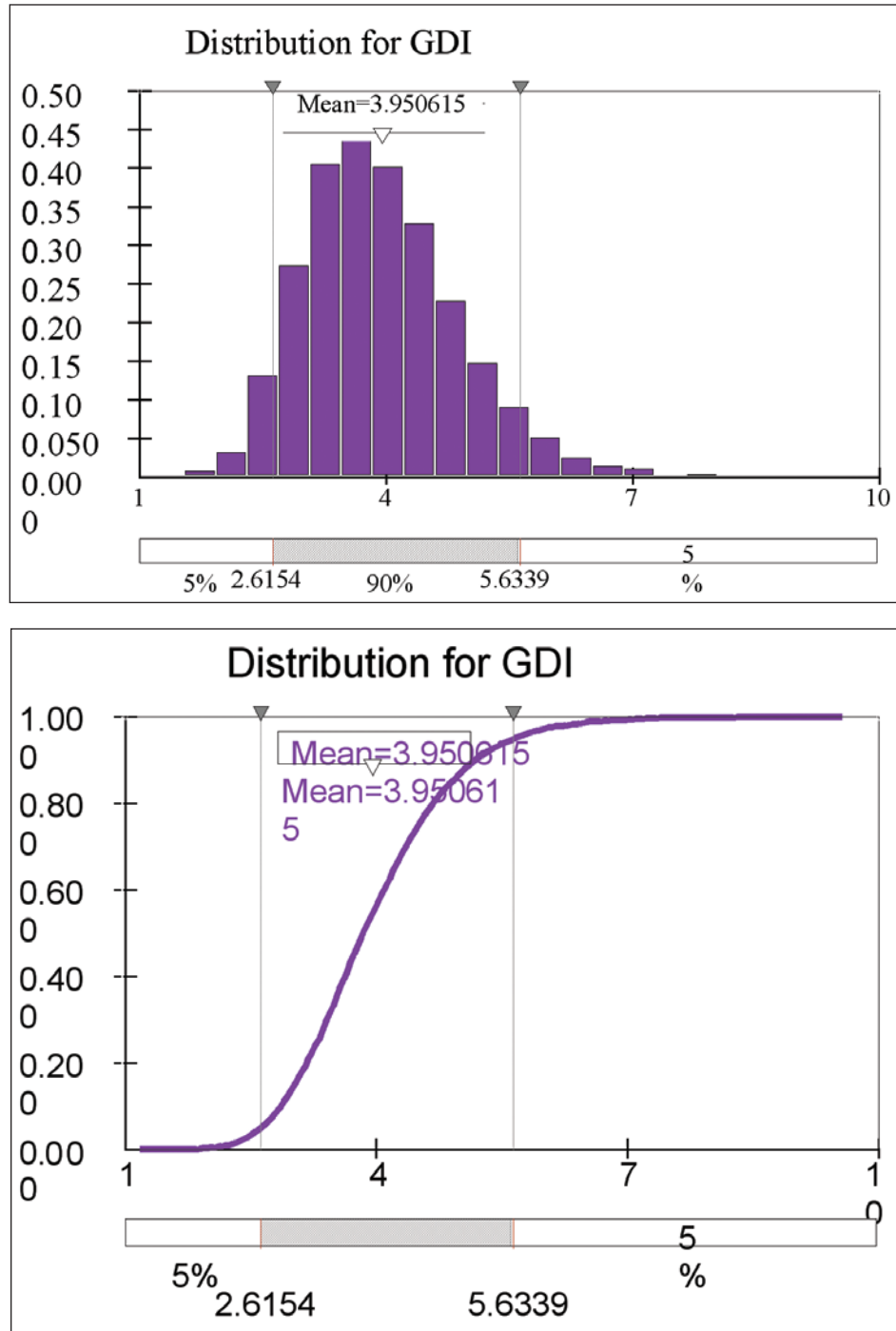

Figure 5-76: GDI output for Station S1



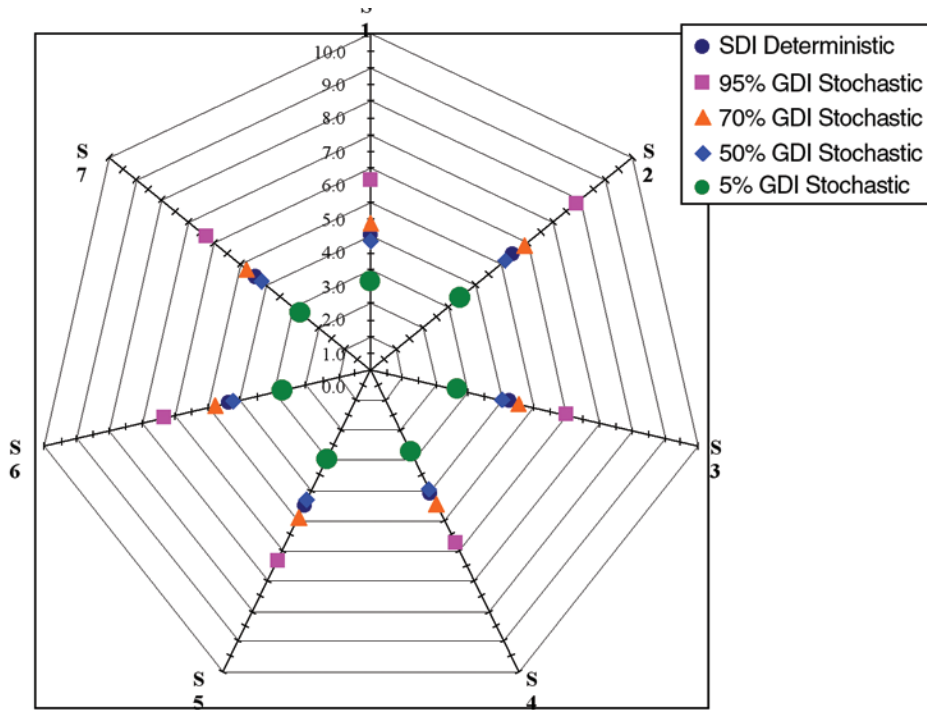

Figure 5-77: Stochastic GDI vs. Deterministic SDI outputs

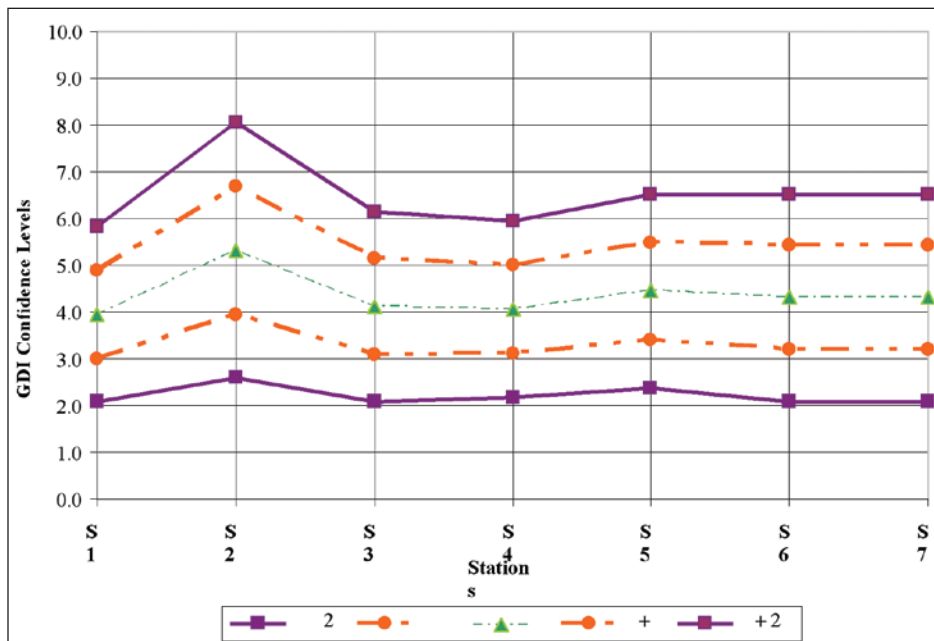

Figure 5-78: Stochastic GDI Confidence Levels

### Regression Sensitivity for GDI

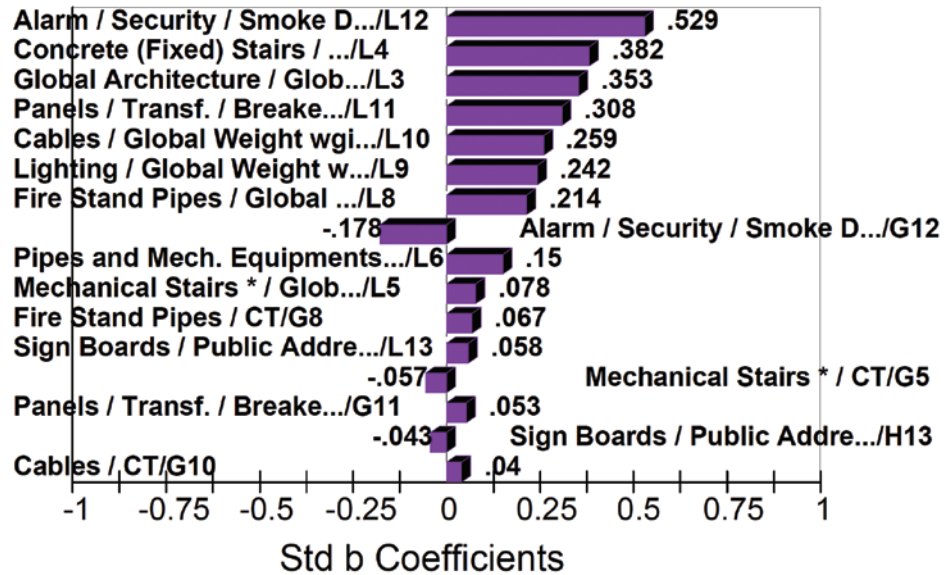

Figure 5-79: GDI sensitivity analysis tornado graph for station S1.

Table 5-27: The SSDI Condition Scale (adapted from Semaan, 2006)

SDI	Description	Deterioration Level (%)	Proposed Action
8 < SDI ≤ 10	Good	<17% Structural or,	Long Term:
		<12% Communications or,	* Expertise < 2 years
		<15% Electrical or,	* Physical < 5 years
		<14% Mechanical	Review in 2 years
6 < SDI ≤ 8	Medium	>17% & <23% Structural or,	Medium Term:
		>12% & <17% Communications or,	* Expertise < 1 year
		>15% & <21% Electrical or,	* Physical < 2 years
		>14% & <21% Mechanical	Review in 1 year
3 < SDI ≤ 6	Deficient	>23% & <35% Structural or,	Short Term:
		>17% & <26% Communications or,	* Expertise < 6 months
		>21% & <33% Electrical or,	* Physical < 1 year
		>21% & <34% Mechanical	Review in 6 months
0 ≤ SDI ≤ 3	Critical	>41% Structural or,	Immediate:
		>30% Communications or,	Physical intervention Now
		>38% Electrical or,	
		>40% Mechanical	

Table 5-28: The GSDM Criteria Definition

I.D.	Description	Function
C1	Global Structure	Structural Architectural
C2	Global Architecture	
C3	Concrete (Fixed) Stairs	
C4	Mechanical Stairs	Mechanical
C5	Pipes and Mech. Equipments	
C6	Ventilation, A/C, Heat	
C7	Fire Stand Pipes	
C8	Lighting	Electrical
C9	Cables	
C10	Panels / Transformers / Breakers	
C11	Alarm / Security / Smoke Detectors	Communication Security
C12	Sign Boards / Public Address Communication System (Telemetry)	

Table 5-29: Summary of Criteria Weights Statistical Analysis Results

Criteria Weights		C1	C2	C3	C4	C5	C6	C7	C8	C9	C10	C11	C12
Average	m (%)	18.8	5.1	12.2	3.9	4.1	5.4	5.0	6.3	7.6	21.2	6.0	4.4
Standard Deviation	s (%)	5.9	2.4	5.0	2.2	2.0	2.4	2.5	3.1	3.8	8.3	3.3	2.5
Standard Error	e (%)	1.2	0.5	1.0	0.5	0.4	0.5	0.5	0.6	0.8	1.7	0.7	0.5
68% Confidence Level	m-s/n <sup>†</sup> (%)	17.6	4.6	11.2	3.4	3.7	4.9	4.5	5.7	6.8	19.5	5.3	3.9
	m+s/n <sup>†</sup> (%)	20.0	5.6	13.2	4.3	4.5	5.9	5.5	7.0	8.4	22.9	6.7	4.9
95% Confidence Level	m-2s/n <sup>†</sup> (%)	16.4	4.1	10.2	3.0	3.2	4.4	3.9	5.1	6.0	17.9	4.7	3.4
	m+2s/n <sup>†</sup> (%)	21.2	6.1	14.2	4.8	4.9	6.4	6.0	7.6	9.1	24.6	7.4	5.4
Normal Distribution	Skewness	-0.24	0.55	0.70	0.20	0.18	0.19	0.005	-0.01	0.33	0.26	0.45	0.23
	Kurtosis	2.09	2.09	2.30	1.40	1.84	2.02	1.83	2.05	1.86	1.68	2.04	1.58
Chi-Sq Test <sup>††</sup>	Test Value	2.25	6.47	2.7	8.08	2.7	2.7	2.7	1.4	2.25	2.25	3.9	2.25
	P-Value	0.69	0.17	0.62	0.09	0.62	0.62	0.62	0.84	0.51	0.69	0.42	0.69
A-D Test <sup>†††</sup>	Test Value	0.26	0.72	0.94	1.19	0.41	0.32	0.37	0.17	0.25	0.65	0.54	0.77
	P-Value	0.25	0.1	0.03	0.005	0.25	0.25	0.25	0.25	0.13	0.1	0.25	0.05
K-S Test <sup>††††</sup>	Test Value	0.1	0.18	0.15	0.19	0.11	0.12	0.11	0.07	0.15	0.16	0.12	0.16
	P-Value	0.15	0.1	0.15	0.05	0.15	0.15	0.15	0.15	0.15	0.15	0.15	0.1

† n = Total No. of data, i.e., 24

†† Chi-Sq statistic test (for a normal distribution) = the Test Value should be close to 0, and the P-Value close to 1 to have the most confidence level that the data follow a normal distribution.

††† A-D (Anderson-Darling) statistic test (for a normal distribution) = the Test Value should be close to 0, and the P-Value close to 1 to have the most confidence level that the data follow a normal distribution.

†††† K-S (Kolmogorov-Smirnov) statistic test (for a normal distribution) = the Test Value should be close to 0, and the P-Value close to 1 to have the most confidence level that the data follow a normal distribution.

Table 5-30: The GSDM Criteria Values Input

Criteria	S1	S2	S3	S4	S5	S6	S7
C1	1	3	3	3	3	3	2
C2	4	4	3	4	3	4	4
C3	3	4	2	1	1	1	4
C4	2	2	2	2	2	2	2
C5	3	2	1	2	4	2	1
C6	1	3	4	1	3	3	3
C7	4	3	1	3	4	2	1
C8	5	5	5	5	5	5	5
C9	4	4	4	4	4	4	4
C10	4	4	4	4	4	4	4
C11	2	2	2	2	2	2	2
C12	2	2	2	2	2	2	2

Table 5-31: The statistical output of the stochastic GSDM for station S1.

S				
Statistic	Value		Percentile	Value
Minimum	1.17		5%	2.6
Maximum	9.57		10%	2.9
Mean	3.95		15%	3.0
Std. Dev.	0.94		20%	3.2
Variance	0.88		25%	3.3
Skewness	0.71		30%	3.4
Kurtosis	4.02		35%	3.5
Median	3.84		40%	3.6
Mode	2.89		45%	3.7
			50%	3.8
			55%	4.0
			60%	4.1
			65%	4.2
			70%	4.4
			75%	4.5
			80%	4.7
			85%	4.9
			90%	5.2
			95%	5.6

Table 5-32: Deterministic SDI values for S1 to S7.

Station	SDI <sub>DETERMINISTIC</sub>
S1	4.0
S2	5.4
S3	4.2
S4	4.1
S5	4.5
S6	4.3
S7	4



# Economic and Social Issues and Impacts



## In this chapter:

The papers in this chapter are focused primarily on the technological aspects of infrastructure design, construction, and management, with some emphasis on advanced and innovative methods of solving technical problems. Looming behind the technological issues, which are difficult enough to solve, are longer-term aspects of an economic and social nature. These relate to the investment in infrastructure, which is already huge, though criticized as insufficient, as compared to major investment issues of health, welfare, and national security to name a few.

The papers in this publication are focused primarily on the technological aspects of infrastructure design, construction, and management, with some emphasis on advanced and innovative methods of solving technical problems. Looming behind the technological issues, which are difficult enough to solve, are longer-term aspects of an economic and social nature. These relate to the investment in infrastructure, which is already huge, though criticized as insufficient, as compared to major investment issues of health, welfare, and national security to name a few.



The papers in this publication are focused primarily on the technological aspects of infrastructure design, construction, and management, with some emphasis on advanced and innovative methods of solving technical problems.

Some of the technical papers in this chapter stress the economic and social importance of infrastructure investment and its present shortcomings:

America's infrastructure has been ignored for decades, is deteriorating, and is inadequate to support the population growth in the near future. The current economic crisis has underscored these issues, stimulating significant outlays of taxpayer dollars

to generate employment in the near term. There is, however, no established decision-support technology to guide the valuation and selection of the optimal portfolio of projects to capture the full benefits of the spending (J. Reese Messinger).

The two papers in this chapter deal specifically with the need to establish infrastructure investment policy from an economic and social viewpoint. While recognizing its value, Richard Cooper casts a critical eye on the present government's stimulus-package approach to the infrastructure problem. The stimulus packages focus on job development and short-term measures, which is understandable in view of the current economic situation:

We continue to spend first, ignore maintenance and return to infrastructure components only when it becomes necessary. This is shocking, considering the amount of money we spend on infrastructure. It might seem laughable if it weren't so troubling...the fundamental lack of a comprehensive national infrastructure strategy only ensures that the existing behavior will continue unless practitioners call for and enact change (Richard Cooper).

In the second paper, Brashear and Creel introduce an important study initiated by the Innovative Technologies Institute (ITI) of the American Society of Mechanical Engineers (ASME), which convened a Working Group made up of distinguished engineers, economists, and risk analysis



and infrastructure experts to define the problems involved in infrastructure investment and develop an approach to solving them.

The initial scope specified a risk/resilience management process for aging infrastructure. Early in the project, however, this scope was recognized as being too narrow: Examining aging infrastructure alone could result in re-building the 20th century infrastructure instead of providing for the needs of the 21st century. Accordingly, the scope was broadened to designing broadly and determining the feasibility of an objective, transparent methodology for valuing and selecting investments in both new and renewed infrastructure that would rationalize and optimize the infrastructure portfolio. To support decision-making at the general executive levels, the methodology must apply to and permit direct comparisons among virtually any infrastructure facility or system, permitting holistic optimization (ASME-ITI, Brashear and Creel).

This paper presents the executive summary of the study and an excerpt describing a key element of the methodology. A reference is provided for the complete report.

### **6.1 State of the Stimulus: The Impact on Infrastructure Protection and a Way Forward**

*Rich Cooper, Principal, Catalyst Partners, LLC*

### **6.2 Optimizing America's Infrastructure Portfolio For the 21st Century**

*Jerry P. Brashear, Ph.D., and James T. Creel*



Papers

## 6.1 State of the Stimulus: The Impact on Infrastructure Protection and a Way Forward

*Rich Cooper, Principal, Catalyst Partners, LLC*

*Disclaimer: The views, opinions, findings, conclusions, or recommendations expressed in this article are those of the author and do not necessarily reflect the official policy or position of the Department of Homeland Security (DHS).*

**F**or all of the ideological, policy and programmatic differences that separated then-candidates John McCain and Barack Obama during the 2008 presidential race, there was one area where both men were in agreement: the reinvestment and rebuilding of America's aging infrastructure. With President Obama now in office, the plan to make this possible is underway.

Shortly after beginning his term, the Obama Administration and the U.S. Congress enacted one of the largest ever spending packages designed to restart a faltering U.S. economy. At \$787 billion, the American Recovery and Reinvestment Act, or the Stimulus Bill as it has subsequently been called, had three primary goals:

- Create new jobs and save existing ones;
- Spur economic activity and invest in long-term economic growth
- Foster unprecedented levels of accountability and transparency in government spending.

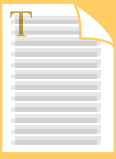

In the last 15 years, U.S. infrastructure has faced terrible challenges to its resiliency. There were the terrorist attacks in Oklahoma City, New York City (World Trade Center), and Virginia (Pentagon), as well as myriad threats made against other U.S. facilities and infrastructure (such as the Golden Gate Bridge and financial institutions). There have also been the cascading effects of natural disasters (e.g., Hurricanes Katrina, Rita, and Gustav). From these experiences, the U.S. must consider its infrastructure in a way dramatically different from days past.

### 6.1.1 Ineffective Infrastructure Projects and Spending

When it was passed, comparisons were quickly made between this economic and infrastructure reinvestment package and FDR's New Deal Programs. Such a comparison is fair given the difficult times in which they were enacted, but it should be noted that the Obama Administration's proposed spending and investments have the potential to eclipse those made during the Great Depression.

Such a large Administration-driven infrastructure reinvestment package is certainly a departure from infrastructure funding efforts in decades past. The overwhelming majority of infrastructure

projects have largely been funded through a number of congressionally driven instruments, such as the Intermodal Surface Transportation Efficiency Act (ISTEA) and its successors: the Highway Trust Fund, various appropriations bills, supplemental funding bills, and Congressional earmarks.

These instruments and others have long been criticized by spending watchdogs and media interests as Congressional “pork-barrel spending,” bringing projects “back home” for powerful members such as former Sen. Ted Stevens (R-AK) and Sen. Robert Byrd (D-WV). A number of these projects have been discovered to have little to no real national infrastructure value, significance, or return on investment.

Because these projects have had such politically powerful champions, there is little an administration could do to stop directed spending, short of a Presidential veto of a full total spending bill. Presidents of both political parties have avoided doing so because the timing of most bills coincidentally coincides with mid-term elections. Furthermore, every administration wants to be seen investing in communities around the Nation, which also contributes to the President’s own electoral fortunes.

### 6.1.2 The Same Old Game

Just as the Obama Administration took ownership of the Executive Branch in January 2009, the ASCE (American Society of Civil Engineers) released their report card on America’s infrastructure. We got a big fat D.

Congress and the Administration had in its hands a credible analysis of the state of the American infrastructure. Years of neglect, inattention, overuse, lack of resources, and more have left us sailing along in a leaky boat with a semi-operable engine in stormy economic seas. This isn’t the first lousy report card our Nation’s infrastructure has received from ASCE. In fact, it seems to be the latest grade in a consistent pattern of underachievement.

In 1998, our infrastructure was graded to be a D. In 2005, ASCE released another Infrastructure Report Card where we also received a D. This was actually a decline from the previous report card issued in 2001 which graded our infrastructure as a D+.

It should also be noted that there are often congressionally mandated studies, NGO wish lists, and other think tank recommendations that provide cover or reinforce the arguments and decisions for some of these individual infrastructure expenditures. A significant number of projects, however, are driven solely by individual Congressional members or State/Regional Congressional delegations. In short, politics has won out over real facts and needs. This is a bold statement, but the facts support it.

We continue to use the same formulas and mechanisms that the U.S. Department of Transportation, the Federal Highway Administration, and others have used for decades when it comes to allocating funding to our roads, bridges, and transportation systems. We also continue to examine our infrastructures through stovepipes rather than looking at them holistically, and as the interdependent systems they have become in our lives and economies.

This is not so much a trend as it is an indictment of the ongoing behavior when it comes to our Nation's infrastructure investment strategies. That is what is so bewildering about the current infrastructure reinvestment effort.

Because of ASCE's admirable efforts, we have a good understanding of our Nation's weaknesses and challenges in a multitude of infrastructure areas. Additionally, in just about any American community, we can see firsthand the poor and overburdened conditions for our roads, bridges, schools, power structures and utilities, and more.

We also know that if we want to remain the world's leading economy, we have to address this incredible national challenge, and do so with efficiency and expediency.

The tragic fact is that under the 2009 Recovery Act, we are shoveling billions more dollars through the same processes that have failed to improve our infrastructure grade for more than a decade. For all the campaign rhetoric about "change," it is not happening.

While there is much to applaud about the Obama Administration's efforts at stimulus spending, transparency, and fiscal accountability, it is important to remember that the goal of the recovery package was job creation and preservation, not new, improved, and resilient infrastructure as many people think.

### 6.1.3 Stimulus Impact on Infrastructure Development

The President put himself politically on the line when he said the stimulus package would create 3.2 million jobs by 2010. Unfortunately this laudable metric has fallen victim to an even more dreadful economy, which has bled more jobs than it has created.

While his opponents use that self-imposed measure to pummel the President for their own political purposes, it is important to note that the only job metric that matters to the American public is a lower unemployment rate—not the arbitrary numerical measure generated by the White House, its campaign staff, or Congress. The family pocketbook wins every time in these measures.

At no time did the President (or those close to him) mention any other metric or measure associated with infrastructure development or

restoration. The only related measure that might reveal infrastructure performance is the Recovery.gov Web site, which allows the public to examine the expenditures made with the Stimulus Bill.

This too has proven to be a challenge, as reporters, GAO auditors, and Congressional Members and staff have found the reporting to be riddled with errors and inaccuracies. These include miscounting jobs created, awarding projects and jobs in Congressional districts that do not exist, and other discrepancies, all welcomed as manna from heaven by the Daily Show's Jon Stewart and other late night comedians.

Describing a "usual" infrastructure project is not really possible either. A typical project is a hodgepodge of smaller projects, as well as funding for road and bridge projects that were already on the books or underway prior to the Stimulus. What we do know according to the GAO's Oct. 30th report on the Stimulus Act is that we have spent \$160 billion and created or saved 640,000 jobs.

As one Congressional staffer described it, "Money from the Stimulus Bill was designed to keep States and locals afloat and prevent them and other businesses from going under."

That does not mean infrastructure projects are not receiving their share of the money. In just about any state and community in the country, signs near road or bridge construction declare that the project's funding came from the 2009 Recovery Act. Here again, it is important to remember that the goal was to create and preserve jobs, not improve the overall health of the Nation's infrastructure.

In measuring the impact of the Recovery Act upon our infrastructure, we are left with a big question mark.

The President's critics and defenders don't agree on much, but both can agree that it takes time for appropriated funds to reach construction zones. Infrastructure does not grow on trees, nor does it appear overnight, and as such, our performance measures cannot be made in the 11 months since the Recovery Act was implemented.

#### **6.1.4 A National Infrastructure Strategy**

The lack of a national strategy to lead to success should not be underestimated, especially in light of President Obama's recent remarks to officers and cadets at West Point.

While trillions of dollars have already been spent over the past several decades on roads, bridges, utilities, and other infrastructure projects, a larger national strategy for infrastructure rebuilding and reinvestment has been missing. As a Nation, we continue to fail to prioritize our needs, and as a result, politics and power (rather than need and development) have been central driving forces for infrastructure reinvestment and rebuilding.

As many Americans watched on December 1st, the President shared that over the past 3 plus month, he has consulted with our Nation's military leaders, Members of Congress, his Cabinet, international allies, the Afghan government, military families, and more in shaping his new strategy for Afghanistan. Regardless of how one views the decision, the President took the time to formulate a path he believes will lead to securing America's interests, a free-Afghan people, and a terror-free world.

But as cautious and deliberative as his approach has been on this issue, the same cannot be said for our Nation's approach to infrastructure investment.

We continue to spend first, ignore maintenance, and return to infrastructure components only when it becomes necessary. This is shocking, considering the amount of money we spend on infrastructure. It might seem laughable if it weren't so troubling.

The fundamental lack of a comprehensive national infrastructure strategy only ensures that the existing behavior will continue unless practitioners call for and enact change. There are three things we can and should be doing to make this change.

### 6.1.5 Push for the Formation of a National Infrastructure Strategy

Those associated with the formation of the National Infrastructure Protection Plan (NIPP) know it is entirely possible to get all necessary Cabinet departments and independent agencies to sign off on a plan. It has been done before as we were all called upon to mobilize how we would protect our national critical infrastructure in the days following 9/11 and Katrina. The same reasoning and urgency that applied to shaping the NIPP should also apply to a national strategy for infrastructure, construction, and maintenance.

It is worth noting that some months ago, the Administration demanded GM, Chrysler, and other taxpayer bailout recipients detail to the Administration the plans for how money would be spent to get each enterprise back on track. Shouldn't the same behavior also apply when making infrastructure investments?

Whether led by a national commission of public and private sector experts, or taken from the existing Federal and Congressional mechanisms, it is essential that the Nation conduct a holistic examination of our national needs to support our economy and security if we want to remain the world's economic powerhouse.

### **6.1.6 Enact and Constitute a National Infrastructure Bank**

The concept of a national, cross-infrastructure body to provide investment capital for critical infrastructures is not new. Such a resource would be a tremendous asset for our ability to provide power, transportation, water, and other needs. In fact, the then-Obama campaign and Obama Transition Team made specific mention of it and the good it could do for helping the Nation address its infrastructure investment needs.

There are several proposed formats for the Infrastructure Bank. Some see it constituted as a Base Realignment and Closure Commission (BRAC)-like structure, led and staffed by non-political subject matter experts operating independently of the Executive and Legislative Branches. Such a model is not without peril or controversy. As history has shown us, every time a BRAC commission meets and makes decisions, there are public rallies and campaigns to save bases and military installations from closing or being changed. Truth be told though, BRAC has offered one of the most holistic, fact- and reality-based approaches to decisionmaking.

Another proposed format is to charter the National Infrastructure Bank as an actual bank or as a Government corporation that State and local governments could approach for loans to support infrastructure projects back home. State and local governments would apply to the bank and be required to justify the infrastructure need, petition for the requested funds, and demonstrate a feasible method for repaying the loan.

To date though, the Administration has done nothing with the Infrastructure Bank concept. However, Sen. Chris Dodd (D-CT) and Rep. Rosa DeLauro (D-CT) have introduced measures in the Senate and House to make the Bank a reality. From discussions with Congressional staff, some type of action is anticipated in 2010.

### **6.1.7 Make Resilience a Part of the Infrastructure Design from the Beginning**

Today is not unusual to hear the term “resilience” bandied about in presentations, reports, or press releases. It has, sadly enough, become a check-the-box word that must be included in any commentary or analysis on homeland security and infrastructure. While the word may be mentioned often enough, there are still people and audiences that don’t understand what it means. Plainly put, resilience is the ability to take a punch, recover quickly, and stay in the ring to come back swinging.

It has been my own experience and observation that the private sector and military are far more adept at this than Government planners. Why? Very simply, it comes down to survival and having the skills, resources, and wherewithal to be able to make it another day.

Businesses have to do this to keep the lights on and cash flowing. If not, they go out of business.

The military also has to do this because it can literally mean the difference between life and death, whether in planning, training, or combat operations. In Government, few worry about these consequences.

Take Hurricane Katrina as an example. Whereas private sector and military resources were able to adapt, react, and recover more quickly, Federal, State, and local governments were unable to adjust to the enormity of the situation until they became overrun by it.

Thanks to the Oak Ridge National Laboratory's SERRI Program and its Community and Regional Resilience Initiative (CARRI), we are now getting a clearer picture of what it takes to have a more resilient community. By examining a range of disasters and misfortunes that have struck the U.S., CARRI has been able to begin defining metrics that make resilience less a buzz word and more an applicable set of processes and methods. Although still in its infancy, CARRI's work is already garnering the attention of the National Security staff at the White House and elsewhere. Indeed, resilience is a theme and concept this Administration is starting to weave into strategy documents, policies, and programs. In 2010, expect to see that much more overtly.

As people who believe in the promise and return of quality infrastructure, it would also behoove us to ask Congress and the Administration how appropriated dollars will provide a more resilient infrastructure. The mechanisms of old, still in-use, to fund, plan, and build our infrastructure, do not take resilience into account. Thus, we must ask: "How will this structure be resilient? What are the metrics and interdependencies to assess performance before an emergency? What 'all-hazard' considerations have been included in planning and operations?" There is a litany of questions to ask; we just have to be bold enough to ask them.

### **6.1.8 Infrastructure Development and a Way Forward**

It is unrealistic to think politics can be removed from infrastructure funding. There will always be earmarks and markups. These will be at play as the Obama Administration moves forward on its Stimulus II plans in early 2010, but the conditions in which this package is shaped are far more



dynamic than those held by the President's predecessors. With a flailing economy and continuing unemployment, there is tremendous pressure and high expectations for the Obama Administration and Congress to get the Nation's financial and employment figures moving in a positive direction.

Furthermore, citizens, communities, and economies are far more dependent on, and interdependent with, our infrastructure. In communities across America, single points of failure (e.g., power blackouts) can cause tremendous impacts and costs that can have long-term consequences to lives, structures, security, and economies.

It should also not go unrecognized that investment decisions are further challenged today because over 80 percent of the Nation's infrastructure is privately owned or operated—something never envisioned when the New Deal and the Interstate Highway system were making their initial investments 50 and 60 years ago. Today, the private sector has greater control over our lives, and its central role in the ownership and operation of our infrastructure cannot be ignored.

History has shown that governments have no problem spending money. Administering, overseeing, and accounting for those expenditures have always been the habitual challenges left to generations of taxpayers. It will be up to the Obama Administration, the Congress, various stakeholders (other public and private sector members), interest groups, and citizens to break this cycle of behavior.

The investment decisions that they make will impact our economy, security, and way of life in unforeseeable ways for several generations. Investing wisely is critical, not only to the short-term recovery of the Nation's economy and employment problems but also to its long-term health and sustainability, our security, and prosperity as well.

A watchful eye will be required to keep politics and carelessness in check if the Nation is to retain its position as global leader in innovation, entrepreneurship, and prosperity. Without the infrastructure to support these three elements, security and sustainability will be out of reach for our children—something no generation of Americans wants its heirs to inherit.

Regardless of the subject area, every step into the infrastructure issue reveals a series of questions and challenges. While answers and responsible authorities remain amorphous to most, if not to all of the infrastructure issues, one thing is certain: billions of dollars are going to be spent over the next several years, and there is no overall road map or strategy to guide those investments.



A watchful eye will be required to keep politics and carelessness in check if the Nation is to retain its position as global leader in innovation, entrepreneurship, and prosperity.

## 6.2 Optimizing America's Infrastructure Portfolio For the 21st Century

*Jerry P. Brashear, Ph.D., and James T. Creel*



It has taken tragedy to bring public and political attention to the deterioration of America's critical infrastructure and the crying need for new systems for the 21st century.

Federal, state and local capital outlays for infrastructure as a percentage of Gross National Product have declined steadily since 1959.

### 6.2.1 The Challenge

**H**urricane Katrina (1800 deaths; \$150 billion in economic losses), Minneapolis's I-35 bridge collapse (killing 13; disrupting the local economy for a year) and the Northeast Blackout of 2003 (denying power to 1/7th of the U.S. population and 1/3rd of all Canadians; with a loss of at least 11 lives and more than \$6 billion)

represent catastrophes that must be avoided in the future.

**Too little invested.** Federal, state and local capital outlays for infrastructure as a percentage of Gross National Product have declined steadily since 1959. The U.S. currently ranks 15th among members of the Organization for Economic Cooperation and Development (plus India and China) in the portion of GNP invested in infrastructure. The Obama Administration's "Stimulus Package," the American Recovery and Reinvestment Act, will add a meaningful increment to the recent level of federal investment, but even with the stimulus, significantly greater amounts will be required to meet the requirements of the 21st century.

**Poorly allocated.** In addition to spending too little, however, the nation is investing too much on the wrong assets, exacerbating the underinvestment. The nation is simply poorly prepared to prioritize and select investment options in a way that optimizes the benefits of the coming historic outlays of taxpayer and ratepayer monies. Myriad bureaucratic and political schemes have evolved for distributing appropriated funds, bond proceeds and capital budgets that individually and collectively fall well short of rational allocation of public resources. The result is a massive opportunity loss as tens of billions of dollars are potentially misspent.

### 6.2.2 The "Clients" for a Solution.

A central impediment to optimal investment in infrastructure is the "stovepiped" nature of the U.S. system for allocating infrastructure

investment: from Congressional authorizing and appropriating committees through to the spade point, infrastructures are never examined as a holistic, interdependent whole.

**Trade-offs across stovepipes can only be made by the “general executives”** – CEOs in industry, governors and mayors, and, of course, the President through their capital budgeting staffs and, by extension through the application/allocation process, the capital improvements planners who propose infrastructure investments. The “infrastructure bank” proposals being considered by Congress and the emerging regional public-private resilience partnerships could potentially add other cross-cutting infrastructure investment perspective. These considerations defined the “general executives” as primary clients for the process.

Trade-offs across stovepipes can only be made by the “general executives”

### 6.2.3 Project Objective and Scope.

ASME Innovative Technologies Institute convened a distinguished Working Group on Infrastructure Investment to design and assess the feasibility of a methodology to address the investment decision-making aspect of the challenge. ASME provided a seed-money grant for a project.

The initial scope specified a risk/resilience management process for aging infrastructure. Early in the project, however, this scope was recognized as being too narrow: Examining aging infrastructure alone could result in re-building the 20th century infrastructure instead of providing for the needs of the 21st century. Accordingly, the scope was broadened to designing and determining the feasibility of an objective, transparent methodology for valuing and selecting investments in both new and renewed infrastructure that would rationalize and optimize the infrastructure portfolio. To support decision-making at the general executive levels, the methodology must apply to and permit direct comparisons among virtually any infrastructure facility or system, permitting holistic optimization.

### 6.2.4 A Feasible, Transparent Solution.

Feasibility of the methodology is demonstrated by defining a series of essential design specifications and outlining a comprehensive analytic process that integrates existing techniques – requiring no major methodological discovery or invention – into a holistic, transparent, objective and defensible approach that meets all the specifications.

**Financial vs. infrastructure portfolio optimization.** The methodology is defined by analogy to financial portfolio optimization. Table 6-1 shows the

conventional financial portfolio approach, the approach adapted for infrastructure investments and the analytic tools required. Financial portfolio optimization must be adjusted for application to real (non-financial) critical infrastructures, e.g.:

- Assuring objectivity and direct comparability of investment options regardless of type, by establishing a common set of definitions, metrics, scenarios, analyses and selection processes – and using these as accountability metrics over time;
- Defining infrastructure value more broadly than most financial portfolios, as a multi-attribute objective that includes not only cost-effective provision of needed infrastructure services, but also the investments’ contribution to other major challenges facing the nation, i.e., global competitiveness, energy independence, sustainability, safety and resilience to disruptions, and national security;
- Conducting the analysis from the respective perspectives of both the infrastructure owner and the public to identify when the business case alone justifies the investment and when major issues of externalities and public goods call for greater public involvement;
- Analyzing explicitly the dependencies and interdependencies in which the investment will operate, especially in the metropolitan regional context, to contribute to the resilience of the entire infrastructure system;
- Including risk and resilience analysis as an integral part of the assessment, thereby addressing the issue of aging infrastructure as well as encouraging security-by-design and resilience-by-design at the most cost-effective stages of infrastructure life-cycle, initial design of new facilities or re-design of existing facilities; and
- Keeping the general approach relatively simple, direct and credible enough to be applied by engineering, analytic and planning staffs and the decision-makers they support – whether private sector, state and local governments infrastructure owners or regional public-private partnerships – with a minimum of outside expertise or training, using data that are readily available.

**Decision-maker flexibility.** The approach is not a “black box” that churns out inflexible “right” solutions. It recognizes that decision-makers operate amidst a variety of very real and changing constraints. Flexibility is provided to the decision-maker in several ways, including:

- Establishing the goals, objectives, criteria and their relative priorities – highest level policy decisions – as the definition of value in the initial step;

- Setting overall budgets levels and basic “pools” within the budget for specific purposes;
- Setting minimum levels of outlay for any proposed project or project type;
- Defining logical relationships among the candidate projects – e.g., if A is selected, B must (or must not) be selected;
- Including “distributional” constraints, e.g., a minimum levels to certain areas, jurisdictions or types of projects; and
- Making final adjustments in the selection among investment options within the selected portfolio to assure support needed for acceptance of the overall program.

Table 6-1. Summary of the Financial vs. Infrastructure Portfolio Optimization Processes

Process for Financial Assets	Process for Infrastructure Assets	Required Tools
<p>Develop strategic goals and plan. Define:</p> <p>a. Strategic and operational objectives &amp; their relative priorities;</p> <p>b. Constraints, e.g., budget total, geographic “balance,” product lines, etc.</p> <p>c. Valuation metrics to measure objectives and constraints.</p>	1. Same	Analytic Hierarchy Process (AHP)
2. Value existing portfolio relative to strategic and operational objectives – gap analysis of value, risk: existing dependencies – from owner’s perspective	2. Same, except from both owner’s and public’s perspectives “dual perspective,” below.	Regional Input-Output Model OR Regional Systems/ Economics Model
3. Assess new financial investment opportunities individually – full value, risk, performance relative to objectives	3. Same, but dual perspective with full multi-attribute value, risk, resilience, etc. – public and owner	Engineering-Economics Model
4. Estimate correlations among existing & new assets or with market as whole (covariance or “beta”)	4. Same, but estimate physical interdependencies among existing & new assets – unintended consequences, cascades & systemic failures	Regional Input-Output Model OR Regional Systems/ Economics Model
5. Optimize investment portfolio – efficient frontier; maximize value at acceptable risk level, within budget & other private constraints (performance, “balance,” lines of business, etc.)	5. Same, but set aside investments private investors will make; then maximize multi-attribute value at acceptable risk level, within budget & other constraints (distributional balance, equity, etc.)	Portfolio Optimizer, either integrated with AHP  OR Specially adapted to examine virtually all investment combinations
6. Examine constrained, optimal portfolios – owner’s perspective only – Select portfolio, invest, manage & evaluate performance for next iteration.	6. Same, but examine constrained optimal portfolios – public’s perspective only – Select portfolio, invest, manage & evaluate performance for next iteration.	Sensitivity analysis using any or all of the above tools

This flexibility does not detract from the method’s objectivity or usefulness, but enhances it by making compatible with the processes in which it must be embedded. These capabilities make it truly useful to the decision-makers, enabling the coalitions necessary to assure passage while optimizing within the constraints makes it the best of all practical and feasible solutions.

### 6.2.5 Outcomes

Introduction of a process that supports rational, transparent infrastructure investment and accountability decision-making will bring the needed discipline to the jumble of processes by which America now makes these vital investments. It will reject “bridges to nowhere” early in the process, expose self-serving proposals and highlight those that are sound. It will elevate emerging values of safety, security, resilience, sustainability, and social equity to their rightful position as decision criteria.

The quality, transparency and consistency of infrastructure investment proposals, selections, plans and capital budgets will rise.

**In the near term.** The quality, transparency and consistency of infrastructure investment proposals, selections, plans and capital budgets will rise. Both selection and implementation will become more accountable. The reality of interdependencies and the logic connecting investment to the social benefits will be clearly defined, options will be

compared, and strategic portfolios will be implemented on regional and national scales.

**Over the longer term.** The outcomes will be measured by the quality and reliability of infrastructure services provided, the resilience in times of duress, the spread of new infrastructure services to growing population, reduction in the number and duration of service denials, and reduction of unit costs of services as new, more efficient assets replace worn and obsolete ones.

**The primary outcome.** Use of this new approach will be a marked increase in the true value of investment in new and renewal infrastructures. Regional economies will expand in sustainable, equitable ways; safety, security and resilience relative to man-made and natural events will be materially enhanced; cascading infrastructure failures will be less likely, less frequent and less widespread; and fewer “wrong” projects will absorb scarce resources. The results will vastly increase the efficiency and global competitiveness of American industry and contribute to the quality of life of all our citizens.

In brief, such an approach would bring “more bridge for the buck, more dam for the dollar, more levee for the levy.” It would delineate the difference between investing hundreds of billions of taxpayer and ratepayer dollars well and spending them poorly, between a significantly higher quality American infrastructure base and risking economic and social stagnation over the rest of the present century.

### 6.2.6 Next Steps

The opportunity to capture the benefits of enhanced infrastructure investment could quickly pass, giving rise to wasted investments, unnecessary projects and unmet needs. This report suggests a two-pronged approach for realizing these benefits:

**Intellectual advocacy.** The first line of development is to join the coalition being developed by the Board on Infrastructure and the Constructed Environment of the National Research Council/National Academies of Science, several professional societies (including ASME), and other groups concerned about America’s infrastructure crisis. This coalition will conduct meetings and studies to advance the understanding of the nation’s infrastructure needs and to educate both the public and those in positions to begin to meet these needs.

**R&D and demonstration.** The second line is to conduct a program of research and development to refine, detail and integrate the defined tools, pilot-testing, then demonstrating them in one or more regions, and transferring the demonstrated methodology as a regional resilience template, essential to any program of reform of the infrastructure investment process.

### 6.2.7 Time Is of the Essence.

Significant investments are being made, and more hundreds of billions of dollars will continue to be spent, regardless of the caliber of supporting analysis or the wasted opportunities to optimize these massive investments. For the United States to capture the full benefit of these outlays, the approach advocated in this study must be completed quickly and correctly – the first time – or the opportunity will be lost. If the challenge is taken up, the decision-support methodology described here will transform the critical infrastructure base and the resilience of individual regions and the American economy for decades to come.

Significant investments are being made, and more hundreds of billions of dollars will continue to be spent, regardless of the caliber of supporting analysis or the wasted opportunities to optimize these massive investments.





# Observations and Conclusions



## In this chapter:

This chapter presents in detail, observations and recommendations from workshop attendees. Participants deliberated on the main issues that pertain to aging infrastructure and the general attributes and needs of infrastructure of the future.

Workshop attendees deliberated on the main issues that pertain to aging infrastructures and the general attributes and needs of infrastructures of the future. Figure 7-1 shows the workshop composition and deliberation issues. Workshop attendee observations and recommendations are presented in detail in this section.

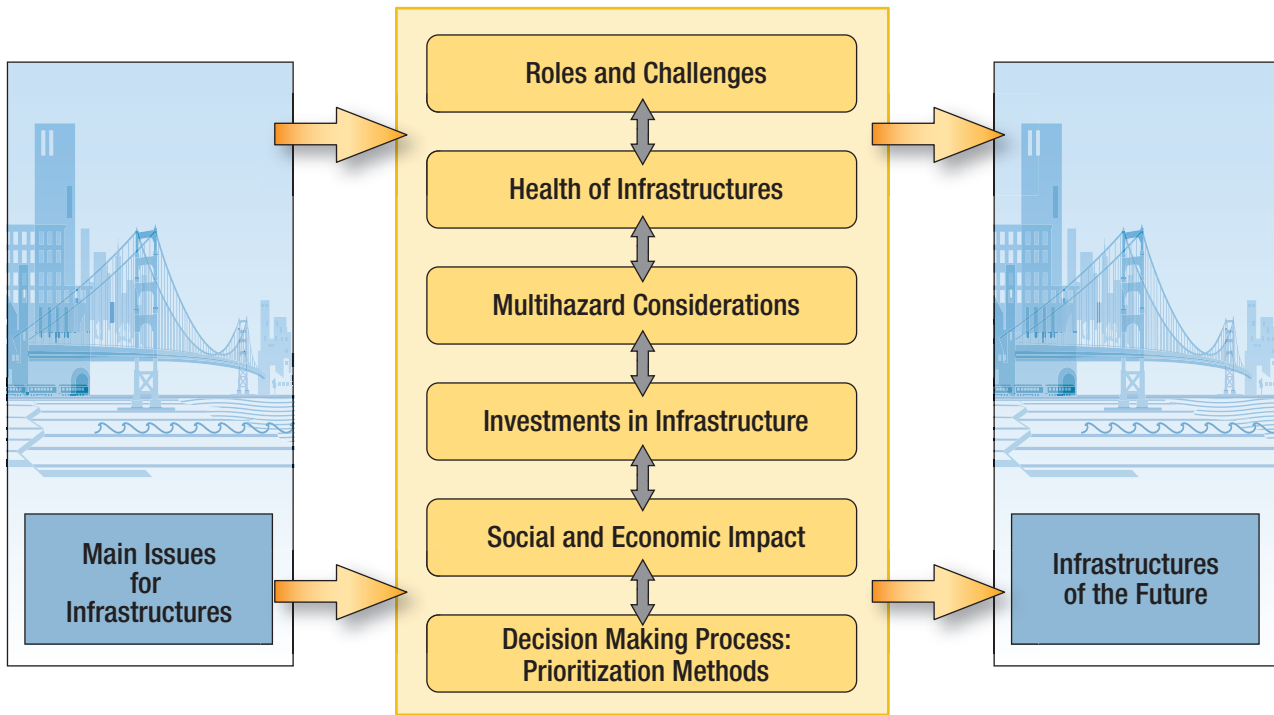

Figure 7-1: Composition of the workshop

## 7.1 Roles, Challenges, and Recommended Solutions

The many stakeholders of infrastructures have varying responsibilities, techniques, operations, goals, and objectives. However, the objectives and goals of all stakeholders are usually the same: operate infrastructures in a safe, functionally efficient, and cost-effective manner.

Given the multitude of stakeholders and their different practices, the workshop tried to address how different roles can be streamlined to ensure consistent goals.

Given the multitude of stakeholders and their different practices, the workshop tried to address how different roles can be streamlined to ensure consistent goals.

Workshop attendees observed that all stakeholders face certain common challenges, such as:



All stakeholders face certain common challenges,

1. Potential inconsistencies among the plethora of potential solutions to similar problems (deterioration, investment needs, security, management techniques, etc.). The stakeholders need to communicate potential solutions and utilize similar approaches, while avoiding redundancy whenever possible.
2. Inconsistent methods and techniques to accommodate interdependencies. Stakeholders should remove any inconsistencies in operations and improve on similarities. For example, lack of expertise/equipment/resources in one stakeholder might be overcome by the resources of another stakeholder.
3. Defining the risks that infrastructures are facing. There is a need to ensure that these risks are being addressed consistently and efficiently by all stakeholders.

Workshop attendees came up with several recommendations to meet the above challenges:

1. Clearly identify who the stakeholders are for different infrastructures.
2. Standardize the process and language across agencies.
3. Set funding priorities. Such priorities need to be consistent among the stakeholders to ensure maximum efficiency.
4. Develop consistent manner for disseminating information.
5. Build consensus among stakeholders. This can be achieved by designing a dedicated outreach program to gain consensus and encourage thinking outside the box.

### 7.1.1 Short-Term Challenges

Short-term challenges identified by workshop attendees include:

1. Increasing interaction among stakeholders and their awareness of decisionmakers' techniques
2. Lack of informed leadership
3. Assessment and prioritization of current environment
4. Lack of funding/sufficient resources
5. Lack of quality information
6. Lack of coordinated initiatives

### 7.1.2 Long-Term Challenges

Long-term challenges identified by workshop attendees include:

1. Lack of funding/sufficient resources
2. Developing a long-term vision
3. Deciding what is critical/necessary/optimal
4. Increasing interaction among stakeholders and their awareness of decisionmakers' techniques
5. Lack of informed leadership
6. Lack of information among industry leaders
7. Lack of coordinated initiatives
8. Lack of sustainable solutions

### 7.1.3 Improving Multidisciplinary Cooperation

Finally, workshop attendees recommended specific methods to improve stakeholder/multidisciplinary cooperation in:

1. Using consistent simulation and exercises across different disciplines
2. Identifying all potential common denominators
3. Coordinating planning among different stakeholders
4. Developing objective methodologies across disciplines and stakeholders
5. Providing a clearinghouse of best practices
6. Linking the practices and basic sciences through entities like DHS
7. Organizing workshops and symposia to bring all disciplines together and continue interaction among them

The methods are illustrated in Figure 7-2.

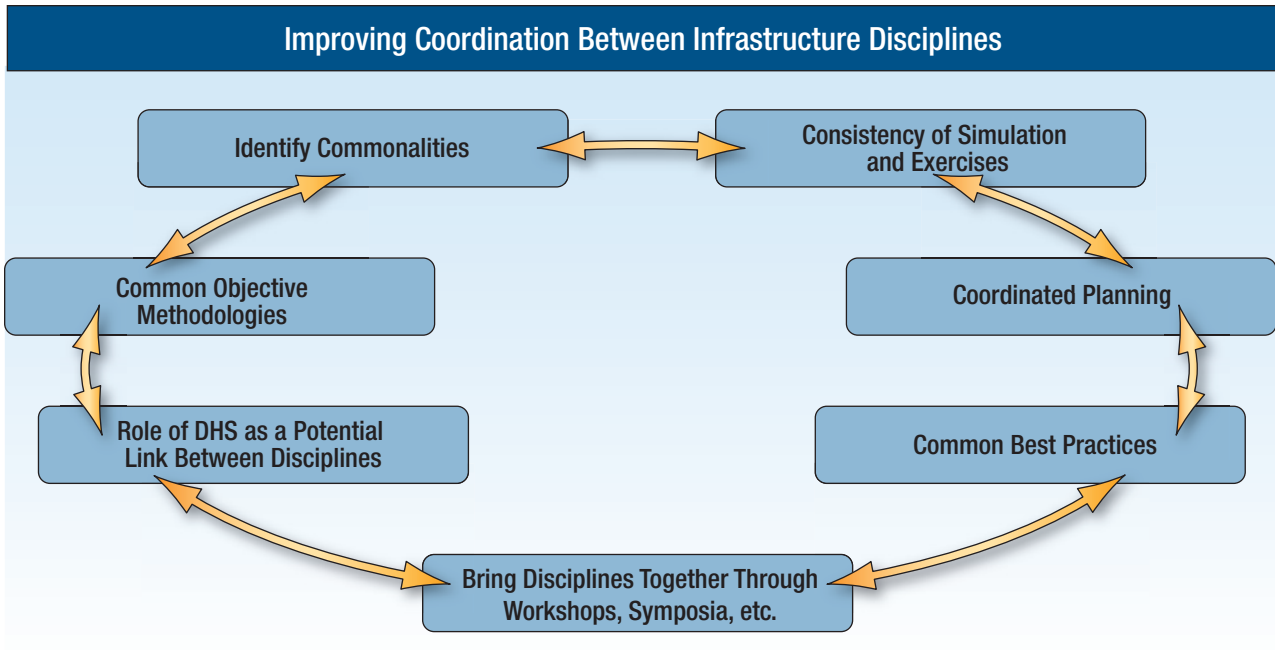

Figure 7-2 – Methods of improving coordination

## 7.2 Infrastructure Health

If we consider infrastructures as organisms, protecting their health is one way of providing solutions to their aging problems. As such, infrastructure health involves many interrelated issues, including hazard definition and mitigation, monitoring damage and behavior, asset management techniques as they relate to optimizing infrastructure health, decisionmaking processes, and methods that reduce operational (inspection, maintenance, rehabilitation, and replacement) costs while maximizing functional benefits of infrastructures.



If we consider infrastructures as organisms, protecting their health is one way of providing solutions to their aging problems.

Workshop attendees agreed that the infrastructure health issues are too complex and wide-ranging to be covered in such a short time; however, they agreed on some of the main principles that would improve infrastructure health, thus helping in addressing the problem of infrastructure aging:

1. Decisionmakers should consider using a risk-based approach to infrastructure investments (including health of infrastructure) and focus on better defining methodology components (threat/hazard, vulnerability, consequences). Some workshop

attendees noted that emerging engineering paradigms, such as performance-based design, are good steps toward using risk-based methodologies in the infrastructure health field.

2. Attendees observed that as infrastructures age, their engineering capabilities deteriorate. This might result in reduction of resilience in response to a terrorist attack. The community needs more information and research about terrorist threats related to infrastructure aging and other natural hazards (both disasters such as earthquakes, wind, and flood, and environmental, such as corrosion, wear and tear, and fatigue).
3. Fatigue and corrosion are important hazards that affect aging infrastructures. However, these two hazards are only part of the problem; accidents and other natural hazards are very important causes for loss of service of many infrastructures.
4. Aging process is a balance between capacity and demands of the infrastructure. Accurate knowledge of both is essential to an accurate decisionmaking process. Technology tends to measure capacity and generally ignore demand. Modern and advanced sensor technology should measure demand. Thus, there is a need to correlate damage detection to capacity and the demands to the expected use of the infrastructure.
5. Awareness, education, and outreach are important. The ASCE report card is successful in raising awareness of the infrastructure aging problems.
6. Taking a long view in managing infrastructures is essential. There is a need for stakeholders to focus on life-cycle analysis. Life-cycle cost considerations are only part of the process. Life-cycle benefit considerations are also essential, but more difficult to consider. Infrastructure owners must be educated on how the incremental costs of enhanced infrastructure designs will yield a cost savings and other benefits in the long term.

### 7.2.1 Specific Critical Infrastructures Health Issues

In addition to the general infrastructure health issues above, workshop attendees provided the following specific critical infrastructures health issues:

1. Critical infrastructures must be inventoried and quantified.
2. The condition of critical infrastructure must be accurately assessed. An assessment should include their exposure to different hazards as well as their vulnerabilities to such hazards.

3. The interdependency and resiliency of critical infrastructures must be accurately understood and recorded.
4. Funding for bridge, and other types of infrastructures, inspections must increase. Efforts should include more time on site, as well as better training and advanced technologies for the inspectors. Inspection programs for infrastructures, especially bridges, should drive preventative maintenance programs. Bridge inspectors and bridge designers should be working together to maximize efficiency.
5. Reactive maintenance, which is the current norm in infrastructure management, is not enough. Investment in increasing awareness and prevention management are needed. This could be achieved through reliance on life-cycle management processes.

### 7.2.2 Short-Term Priorities to Improve Infrastructure Health

Workshop attendees devised the following as short-term priorities for improving infrastructure health:

1. Advanced decisionmaking techniques, such as cost-benefit paradigms, need to be considered in infrastructure management. Methods to prioritize investments are also part of advanced decisionmaking processes and must be integrated within the infrastructure health community. These methods should focus on balancing the investments in retrofits versus new construction.
2. Advanced materials must be created based on projected demands of the critical infrastructure. The current efforts by DHS to create an advanced materials database should promote awareness and encourage the utilization of advanced materials for both aging and new infrastructures.
3. A gap exists between efforts to collect infrastructure health data and the decisionmaking process on how to best use the data. Research is needed on how to apply collected data to the decisionmaking process.
4. Research should consider what is causing the infrastructure to fail or deteriorate, not just measure its failure or deterioration.



Advanced decisionmaking techniques, such as cost-benefit paradigms, need to be considered in infrastructure management.

### 7.3 Role and Importance of Multihazards Considerations

**M**ultihazards considerations have gained importance lately because of the increasing costs of hazards (earthquakes, floods, hurricane, tornadoes, etc.). The main premise of multihazards considerations is that different hazards can affect given infrastructures in one of two manners: a beneficial manner or an inconsistent manner. If the stakeholders accommodate the beneficial effects of different hazards, cost savings can be realized. If the stakeholders accommodate the inconsistent effects of different hazards, safer designs can be realized.

Multihazards considerations have gained importance lately because of the increasing costs of hazards (earthquakes, floods, hurricane, tornadoes, etc.).

Workshop attendees deliberated on the roles and importance of multihazards considerations as they affect aging infrastructures. Attendees observed that there was too much breakdown of stakeholders into “stovepipes.” DHS can take a leadership position in bringing Federal groups together. Considerable work being done in the private sector is not being shared across country. Bringing together all stakeholders and seek consensus in the priorities, roles, and responsibilities is critically important. The Federal Government can have an important role in encouraging development and sharing of baseline metrics, e.g. in award; similar to the IRB process. Also, some attendees noted the need for discussions to clarify the roles and responsibilities of all stakeholders and find ways to work together. In addition, top-down and bottom-up approaches should be pursued simultaneously to fully integrate local stakeholders: institutional processes are needed.

Attendees suggested re-consideration of regulatory policy as an area for research. So as not to be coercive, also look at areas where insufficient data are available for decisions so regulatory agencies might play a role. During the discussion of multihazards research, attendees noted that private industry/research entities are VERY reluctant to receive risk assessments due to potential liabilities. Attendees suggested that this is a real impediment to fulfilling the promise of multihazards considerations. Another area of potential research is multihazard risk modeling. While success has been achieved in integrating security methods with risk assessment methodology, it has not been done for multihazards. Multihazard risks need to be modeled, including multi-failure mechanisms.

Attendees observed a lack of accepted risk assessment methodology across infrastructures. Sector interdependencies need to be modeled and better understood. Some attendees mentioned a need for valid performance metrics and standards to design, build, assess, and test systems for higher degrees of performance. This need includes agreement



among stakeholders on the scientific basis of standards and work toward establishing more performance standards.

Several additional factors emerged during workshop discussions, including structural aspects of infrastructure and functional obsolescence. Functional obsolescence is probably a growing issue; i.e., consider de-prioritizing efforts to extend life of soon to be obsolescent systems. In this regard, DHS can play a role in developing guidelines to avoid committing time and money to obsolescent systems (e.g., transportation, energy).

Another recommendation by attendees in the field of multihazards is the development of a means of information sharing, e.g., an integrated database (although there are logistic issues). The complex challenges of multihazards require access to many more kinds of information (in addition to security issues). An excellent example of a challenge is how to expand the National Bridge Inventory (NBI) by explicitly incorporating aging. Building similar databases for other infrastructures was also suggested.

## 7.4 Investments In Infrastructures

Improving the conditions of aging infrastructures and building newer and healthier infrastructures require investment. Workshop attendees deliberated on the importance of investing for healthy infrastructures. General guidelines recommended by the workshop body include:

Improving the conditions of aging infrastructures and building newer and healthier infrastructures require investment.

1. Base investment decisions on technical, social, and economic information. Politics should be kept out of funding decisions.
2. Risk communication is important to infrastructure investment and requires obtaining effective buy-in from the general public.
3. Given the limited resources, balance resources to provide basic services. Such a balance can be achieved by various decision-making processes.
4. In the short term, improve inspection and maintenance. In the long term, develop new technologies and deploy new materials and new types of structures with better performance characteristics (higher redundancies, for example).
5. Develop better condition assessment techniques for both existing and new construction. Advanced technologies and prioritization methods can be of help in achieving this important task.

6. The extra focus on bridges as an infrastructure may be warranted due to the multimodal and bottleneck nature of bridges, and the possibility of serious casualties.
7. Maintain current systems in optimal condition by optimizing the allocation of resources. For the long term, collaborative transition planning (e.g., design build perspective) with public buy-in is possible solution.
8. Caution is needed when executing shovel-ready projects. Such projects can be obsolete and not beneficial in the short and long terms. (These are projects that otherwise wouldn't have been executed because of scarce funding.)
9. Because many stakeholders may be hesitant to adopt new technologies, encourage adoption by:
  - Federal Government taking the risk
  - State or Federal governments mandating adoption
  - Considering out of the box methods for collaboration of the public and private sectors
  - Providing incentives

Workshop attendees went on to explore specific priorities for short- and long-term investments, as follows.

### 7.4.2 Infrastructure Short-Term Priorities

The dilemma with short-term investments is that it requires balancing immediate needs with a long-term view. Achieving such a balance is not an easy task. Workshop attendees offered these specific short-term investment priorities:

1. Perhaps the most important priority in the short term is to keep the current systems running, starting with basic services that are offered by each infrastructure.
2. Use stimulus funding to jump start new technology for industries that may not want to undertake the risk.
3. Improve inspection techniques to incorporate, among other things, structural health monitoring and nondestructive testing.
4. Balance short- vs. long-term investment considerations using life-cycle analysis, cost-benefit considerations, and resiliency considerations.

### 7.4.2 Infrastructure Long-Term Priorities

Long-term investments offer the key to resolving infrastructure aging problems and ensuring their health in the long term. Workshop attendees offered the following specific long-term investment priorities:

1. Newer materials are a basic need for the long-term infrastructures health. Investments in finding such materials are essential. Materials should be multifunctional, environment friendly, and energy efficient, and should offer superior engineering properties such as resistance to deterioration and corrosion. They must also be cost effective, self sensing, and self healing.
2. Investment in new methods to design, conduct analyses, and perform inspections. This includes shift design paradigms to build infrastructures with maintenance in mind. An example of an investment that has the potential of reaching such a goal is the Federal Highway Administration (FHWA)-sponsored long-term bridge program (LTBP).
3. When designing new infrastructures, plan for future expansion, alternative use, or demolition. An example of successful expansion is expanding George Washington Bridge in New York / New Jersey to have a second level.
4. Utilize Building Information Modeling (BIM) for other infrastructures. BIM is a successful new technique being used in the building community. It offers the promise of efficient future maintenance/rehabilitation and restoring of buildings.
5. Develop and invest in infrastructures that perform self diagnostics and are self-healing.

### 7.5 Social And Economic Impacts

The social and economic issues of aging infrastructures are closely related. Given the essential functions and costs of infrastructures (e.g., bridges), these relationships are not surprising. Workshop attendees discussed these relationships and various methods to accommodate social and economic impacts of aging infrastructures. Attendees drew the following conclusions:

1. More comprehensive cost-benefit analyses are needed to better communicate different needs to decisionmakers and the public (risk communication). The resulting information must be

The social and economic issues of aging infrastructures are closely related.

simple, accurate, and comprehensive. The methods must also include environmental, energy, and security issues, in addition to social, economic, and cost/benefit aspects.

2. In general, the public must be better educated and kept in the loop during the decisionmaking process. Educating the public on the true value of infrastructure could increase infrastructure investments.
3. Research is needed to demonstrate the relationships between improving infrastructure and improvements to local, regional, and national businesses and communities.
4. Investments in public education should include education of students and future decisionmakers is especially important.
5. Civil Engineering education has become a commodity with no innovative thinking. Civil engineering education must be improved to teach thinking “out of the box.”
6. Appropriate documentation of infrastructure projects is needed (1 percent of all project costs was suggested as a goal for documentation cost). Such documentation will allow for a better understanding of the infrastructure’s future performance. BIM can be used to achieve such a goal.
7. The interaction of new and old construction materials should be researched. In many situations, interconnections of newer materials with older materials have not performed well in the long run. Neglecting this important issue can result in negative safety and cost implications.

### **7.5.1 Important Social and Economical Issues with the Largest Impacts That Should Be Maximized**

Workshop attendees provided specific important social and economic issues that would impact aging infrastructures most:

1. Educating the public and decisionmakers regarding the value of infrastructures, and the need for continued and improved investment opportunities, will have the greatest impact on improving aging infrastructures. Abnormal hazards occurrences, such as hurricanes or earthquakes, might provide opportunities to demonstrate the importance of healthy and resilient infrastructures.
2. A holistic community approach to infrastructure security is needed to optimize the social and economic performance of

- infrastructures. Such an approach will require some changes in the culture and attitude towards infrastructure management (inspection, maintenance, rehabilitation, etc.). This is also a risk communication issue.
3. The essential and close relationships between investment and healthy and resilient infrastructures must be communicated to stakeholders. Also, for optimal improvements of infrastructures (cost and function), competitive practices will naturally result.
  4. Research is needed to study connections between aging infrastructure and the green movement (sustainability and energy efficiency), as well as security. A pioneering activity in this direction is the upcoming (December 2009) summit for Security, Energy and Environment being coordinated by National Institute of Building Sciences (NIBS) for DHS S&T/IDD.

### 7.5.2 Investments That Would Maximize Those Issues

Among potential solutions that workshop attendees suggest in this regard:

1. Develop and build tools that tie infrastructure to investment and competitiveness. These tools can be based on decision-making processes. Validation of these tools is paramount so that decisionmakers can comfortably make the right decision, even if such a decision is not popular.
2. Change the public attitude towards infrastructure. One possible way to achieve this goal is market infrastructure in a way that the public sees value. This is another use for risk communication methodologies.

## 7.6 Decisionmaking Processes: Prioritization Methods

**G**iven the large number of infrastructures and the even larger number of maintenance, rehabilitation, and retrofit projects needed for aging infrastructures, as well as the limited funding for such projects, they must be prioritized. To accurately prioritize infrastructure projects, metrics must be defined. The workshop assembly deliberated on the metrics issue. Attendees discussed three specific topics regarding metrics of infrastructure prioritization methods:



To accurately prioritize infrastructure projects, metrics must be defined.

### 7.6.1 Performance Requirements for Metrics

Workshop attendees came up with the following performance requirements for prioritization metrics:

1. Metrics should be different for different types of investments. For example, metrics used to prioritize retrofit projects should be different from metrics to prioritize new construction.
2. Several metrics should be used; no single evaluation system is sufficient or practical. For example, the National Bridge Inventory (NBI) uses condition rating, serviceability rating, etc. for metrics, while the NY State Bridge management uses structural condition, potential hazards, and vulnerability as metrics.
3. If resiliency is used as a metric, a consensus definition of the 2-Rs (or 4-Rs) must be established.
4. Differentiate between disaster recovery and business continuity approaches to assets. An example is mission critical networks (resiliency of processes vs. resiliency of structural systems). Also, the quality of procedures in place to shut down and bring back service in orderly fashion must to consider the variability of those systems.
5. Consider weighting measures for interdependent assets.
6. Functional/impending obsolescence should be a weighting/ranking factor.
7. Metrics, codes, and standards may not be applicable across the Nation; adapt to regional/sector-specific issues.
8. Metrics must be “living,” flexible, and adaptable.
9. Metrics must be standardized.

### 7.6.2 Workshop Suggestions for Metrics (using resiliency as an example):

Workshop attendees provided the following suggestions for infrastructures prioritization metrics:

1. The 4 Rs can be used as metrics, but they need standardized definitions.
2. Resiliency is an emerging important decisionmaking concept and should be used. As a metric it can be defined in terms of length of time until service is restored:

3. A combination of criticality and vulnerability of assets can be used as prioritization metric.
4. The probability of events might be a useful metric in certain conditions.
5. Single points of failure should be accounted for in establishing metric.
6. Risk is a popular metric that should be used and is generally defined as:
7. When used as a prioritization metric, consequence should be considered as loss of asset or denial of service, and should be based on public health/safety, socioeconomic impact, and environmental impact.
8. For a financial value/cost-benefit analysis approach, investment and returns on investment could be the basis for a metric.
9. Use metrics that are used by engineering network reliability professionals in designing networks. This will help in developing optimal reliability metrics.
10. No reliability analysis is available for infrastructure needs, so a method would need to be determined.
11. Probabilistic tools such as Bayesian network analysis with many nodes for resilience and sensitivity analyses are especially good for increasing data points.
12. DHS IP has successfully developed and applied risk analysis tools that can be adapted to infrastructure prioritization metrics.
13. Use current national code standards to develop pertinent metrics. Those codes were developed based on rigorous engineering criteria; they can be valuable and accurate prioritization metrics.

### 7.6.3 Role of Private Sector in Adopting Metrics

Private sector investments in infrastructures can be a major source of funding. A major step in achieving this important goal is to encourage the private sector to adopt standardized infrastructures prioritization metrics. Workshop attendees deliberated on different methods of encouraging the private sector to adopt prioritization metrics and produced the following ideas:



A major step in achieving private sector funding is to encourage the private sector to adopt standardized infrastructures prioritization metrics.

1. DHS can help private sector develop metrics.
2. DHS can provide metrics and strongly recommend that the private sector use these metrics.
3. Develop strong standards and prioritization methods that are perceived to be rigorous.
4. Encourage the private sector to participate in developing prioritization metrics.

## 7.7 Infrastructures Of The Future

### 7.7.1 General Issues

The workshop defined many general issues that relate to infrastructures of the future. Some of these issues are:

1. Build for renewal and ease of replacement into original design.
2. Be much more modular looking forward—infrastructure must be inexpensive and temporary, have mid-life service, and be longer lasting—and have a menu of options.
3. Infrastructure of the future should have a lower level of maintenance. This means improving awareness of lifetime maintenance needs.
4. Need to build funding to maintain and replace the infrastructure we build today.
5. Short-term sacrifices for owner/operators may be needed to yield long-term dividends. Need to also focus on multihazards approach.
6. Need a specific list of priorities, more than the ASCE report card offers. How do we go from infrastructures with a “D” grade to a “B” grade?
7. Need to focus on future demands (how much water? how much traffic? etc.), then look at ways of providing it that fit the standards, objectives, and key metrics.
8. Need a national initiative with buy-in from the public—we need public outreach to gain support => Risk communication.
9. Need an attractive vision. Governments at all levels need to put together this story and make a business case as to how to create this infrastructure of the future. We will need a public campaign, starting with the youngest generation.



10. Need to deal with political realities and constraints.
11. Need to consider population trends, not just population growth (i.e., where is the growth).
12. Need national leadership for replacement vehicle to generate funding.

### 7.7.2 Characteristics of Infrastructures of the Future

When asked to describe the attributes of infrastructures of the future, the workshop assembly offered the following attributes:

1. **Flexibility:** Future infrastructures need to provide services, be sustainable, and accommodate future capacity and uncertain needs.
2. **Maintainability:** Maintenance efforts need to be built-in from the ground up. These efforts might include the utilization of self-healing and self-sensing materials. Newer structural systems that incorporate features of advanced materials need to be developed.
3. **Inspectability and access to power:** Future infrastructures need to be inspection-friendly, which could involve using advanced materials with built in sensing mechanisms.
4. **Rapid Assessments:** Tools are needed to allow rapid assessment of infrastructure.
5. **Sustainability.**
6. **Visibility:** Infrastructures need to connect with the public.
7. **High social capital:** Designing infrastructure with high social capital will help to increase resiliency.
8. **Broad applicability:** Infrastructures should serve many goals and objectives—sustainability, serviceability, and security.
9. **Green:** Infrastructures should use recyclable materials and new materials that minimize human health issues.
10. **Multi-functionality:** Future infrastructures should consider the effects of decisions on other systems.
11. **Clear Metrics:** The standards, objectives, and definitions of key metrics (environmental, social-health-safety) should be clear.
12. **Holistic:** Need a holistic approach to designing new infrastructures.

### 7.7.3 Investments for Infrastructures of the Future

Workshop attendees focused their attention on the issue of investments for the infrastructures of the future. Given the safety and cost needs of infrastructures, attendees felt that one way to showcase new designs, materials, and concepts is to invest in pilot projects. The infrastructures



Given the safety and cost needs of infrastructures, one way to showcase new designs, materials, and concepts is to invest in pilot projects.

owners must be convinced not to repeat existing designs, and to take bolder steps to incorporate more advanced concepts. Funding from Federal, State, and local levels should have “strings attached” to mandate new approaches and concepts. Finally, creative and “out of the box” models are needed for funding and investments.

A

# Workshop Breakout Sessions: Topic Matrices

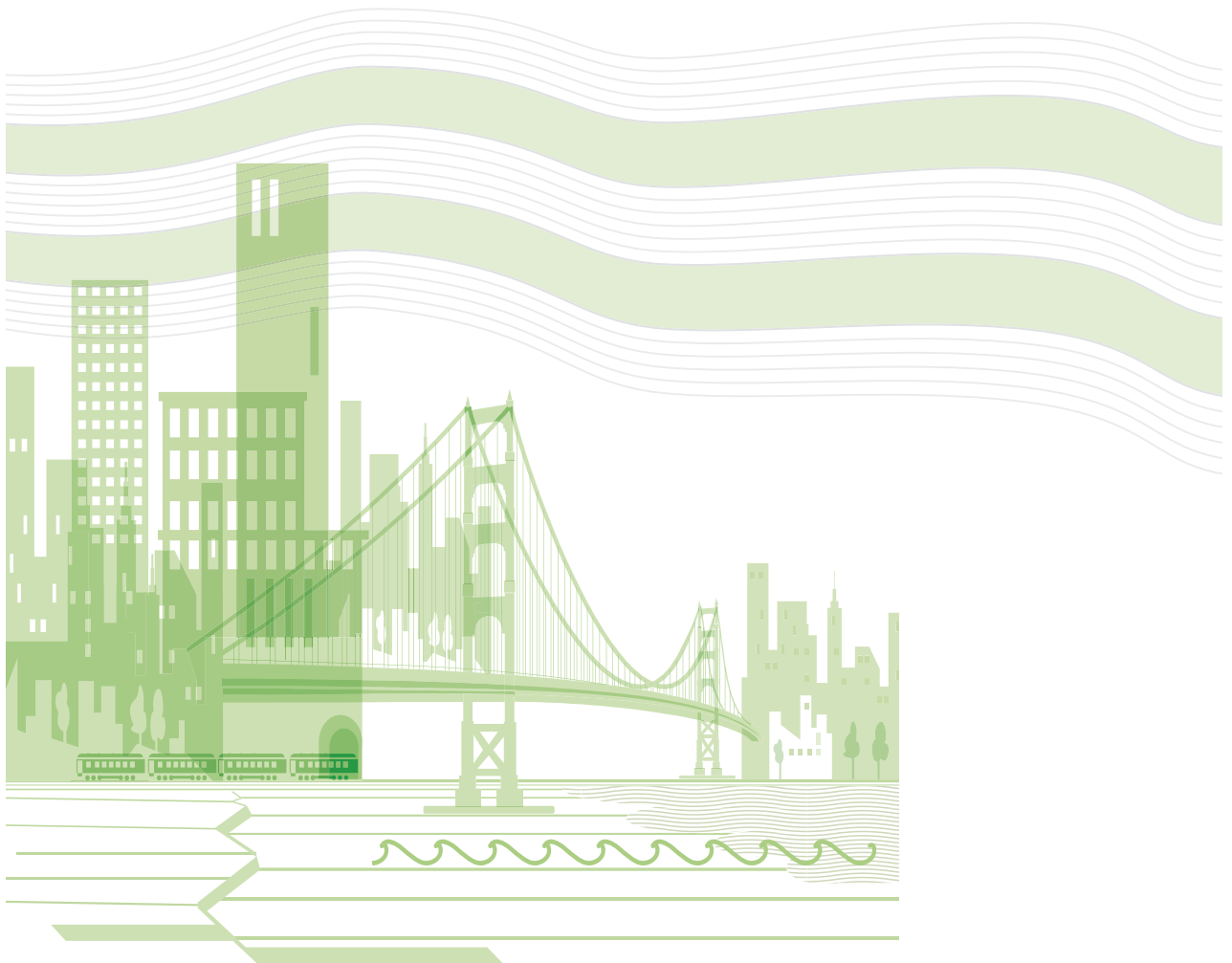

Aging Infrastructure Workshop Breakout 1: Roles and Challenges – Overall							
Day 1: Challenges							
Roles and Challenges: Stakeholders	Infrastructure Age, Current and Near Future Condition, Performance	Risk of Failure – Partial, Catastrophic	Uncertainty and Unpredictability of Threat and Consequences (Including Cascading Effects)	Lack of Funding	Lack of Leadership	Lack of Priorities and Longer-Term Vision – and of Decision Tools and Means of Setting Priorities	Interaction Between Stakeholders
Government – Local-State-Federal (Public Sector)	<p>What are the challenges today from different perspectives?</p> <p>Do the definitions of the challenges vary depending on the roles of the stakeholders?</p> <p>How do the different stakeholders impact the challenges?</p>						
Managers, Operators, Owners (Private), Vendors, Manufacturers							
Experts, Consultants, Professional Organizations							
Academic-Research Entities and Individuals	<p style="text-align: center;"><b>Key Discussion Points</b></p> <ul style="list-style-type: none"> <li>■ Standardizing the process and language across agencies</li> <li>■ Setting funding priorities</li> <li>■ What are the risks that infrastructures are facing and/or what risks are being addressed?</li> <li>■ Uncertainties of interdependencies</li> <li>■ Dissemination of information</li> <li>■ Lack of expertise/equipment/resources and the need to leverage more</li> <li>■ Building consensus among stakeholders                             <ul style="list-style-type: none"> <li>Dedicated outreach program to reach consensus</li> <li>Catalyst for change for all agencies/sectors—“thinking outside the box”</li> <li>Identify stakeholders</li> </ul> </li> <li>■ Interdisciplinary cooperation                             <ul style="list-style-type: none"> <li>Use of simulation and exercises that help in identifying the common denominator</li> <li>Coordinated planning</li> <li>Objective methodologies across disciplines</li> <li>Clearinghouse of best practices</li> <li>Link the practice and basic science through entities like DHS</li> <li>Workshops to bring all disciplines together and continue interaction</li> <li>Outreach effort to those not present at workshops</li> </ul> </li> </ul>						
Civil Society Groups and Entities							



Aging Infrastructure Workshop Breakout 1: Roles and Challenges – Overall		
Day 1: Challenges		
Which two specific challenges are the most important to address in the short term and longer term?		
Challenges: Priority	Short-Term “Top Priority” (1-3 years)	Longer-Term “Top Priority” (4-7 years)
Infrastructure age, current and near future condition, performance	<ol style="list-style-type: none"> <li>1. Interaction among stakeholders and increased awareness of decision-makers</li> <li>2. Lack of informed leadership</li> <li>3. Assessment and prioritization of current environment</li> <li>4. Lack of funding/sufficient resources</li> <li>5. Lack of quality information</li> <li>6. Lack of coordinated initiatives</li> </ol>	<ol style="list-style-type: none"> <li>1. Lack of funding/sufficient resources.</li> <li>2. Long-term vision</li> <li>3. Deciding what is critical/necessary/optimal</li> <li>4. Interaction among stakeholders and increased awareness of decision-makers</li> <li>5. Lack of informed leadership</li> <li>6. Lack of information among industry leaders</li> <li>7. Lack of coordinated initiatives</li> <li>8. Lack of sustainable solutions</li> </ol>
Risk of failure – partial, catastrophic		
Uncertainty and unpredictability of threat and consequences (including cascading effects)		
Lack of funding		
Lack of leadership		
Lack of priorities and longer-term vision – and of decision tools and means of setting priorities		
Interaction between stakeholders		
Increase the level of awareness of issues		

Aging Infrastructure Workshop Breakout 2: Health of the Infrastructure										
Day 1: Challenges										
Roles and Challenges: Stakeholders	Infrastructure vulnerability and security	Infrastructure Performance, Resiliency, and functionality	Cost-Benefit Analysis	Effective Inspection, Maintenance, and Rehabilitation	Energy Use, Sustainability, and Environmental Impacts	Use of State-of-the-Art Technologies, Materials, Concepts, Regulations	Effective Integration: Among Sectors	Effective Integration: Among Local, Regional, and National Entities	Effective Integration: A Among Stakeholders and Disciplines	Other
<p>Aviation</p> <p>Wastewater</p>	<p>What is the health of the infrastructure? Do you agree with the ASCE assessment? How do different parts of the infrastructure compare in terms of some of more specific metrics, e.g., security, regular maintenance needs, energy use, integration? Which metrics are most important for dealing with aging problems?</p>									
	<p style="text-align: center;"><b>Key Discussion Points</b></p> <ul style="list-style-type: none"> <li>■ Consider using a risk-based approach to infrastructure investments (including health of infrastructure) and focusing on better defining its components (threat, vulnerability, consequences).</li> <li>■ We need more information about terrorist threats vs. aging and natural hazards.</li> <li>■ Fatigue and corrosion are only part of the problem; accidents and natural hazards are very important.</li> <li>■ Technology tends to measure capacity and not just demand; advanced sensor technology should measure demand.</li> <li>■ Need to correlate damage detection to capacity and expected use of the infrastructure.</li> <li>■ Awareness, education and outreach are important. In this respect, the ASCE report card is a success.</li> <li>■ We need to focus on life-cycle costs and educating infrastructure owners of how the incremental costs of enhanced infrastructure designs will yield a cost savings in the long term.</li> </ul>									



Aging Infrastructure Workshop Breakout 2: Health of the Infrastructure		
Day 1: Challenges		
Regarding the overall health of the infrastructure, what do you believe are the two most important issues to address now?		
Challenges: Priority	Critical Infrastructure Health Issues	Short-Term "Top Priority" (1-3 years)
Infrastructure Vulnerability and Security	<ol style="list-style-type: none"> <li>1. Need an inventory and condition assessment of critical infrastructure.</li> <li>2. Need to better address interdependency and resiliency of infrastructure.</li> <li>3. Funding and effort on bridge inspections needs to increase and more "time on site" should occur. Bridge inspection programs should drive preventative maintenance programs. Bridge inspectors and bridge designers should be working together.</li> <li>4. We need to move away from reactive maintenance and invest in awareness and prevention.</li> </ol>	<ol style="list-style-type: none"> <li>1. Need to address the cost-benefit balance and create a method to prioritize investments. This should include a focus on balancing the investments in retrofits versus new construction.</li> <li>2. Need to create advanced materials based on projected demands of the critical infrastructure.</li> <li>3. Need to bridge the gap between collecting infrastructure health data and the decision-making process on how to apply the data properly.</li> <li>4. Need to research what is causing the infrastructure to fail, not just measuring its failure.</li> </ol>
Infrastructure Performance, Resiliency, and Functionality		
Cost-Benefit Balance		
Effective Inspection, Maintenance, and Rehabilitation		
Energy Use, Sustainability, and Environmental Impacts		
Use of State-of-the-Art Technologies, Materials, Concepts, and Regulations		
Effective Integration Among Sectors		
Effective Integration Among Local, Regional, and National Entities		
Effective Integration Among Stakeholders and Disciplines		

**Aging Infrastructure Workshop Breakout 3: Multi-Hazards**  
**Day 1: Challenges, Option 1**

<b>Infrastructure Area:</b> Multi-Hazards	
Deterioration And Aging	<p>How do we move from a one-hazard-at-a-time approach to a true multi-hazard approach?</p> <p>Which multi-hazard challenges do we understand best? Least? Are we best prepared to deal with? Least prepared to deal with?</p> <p>Where have we made the most progress in recent years? Least? Why?</p>
Natural Disasters	
Localized Accidents	
Region-Wide Failures	
System-Wide Failures	
Cascading Infrastructures Failures	
Terrorism – Explosives	
Terrorism – Cbrn	

**Aging Infrastructure Workshop Breakout 3: Multi-Hazards**  
**Day 1: Challenges, Option 2**

Infrastructure Metrics: Multi-Hazards	Infrastructure Vulnerability and Security	Infrastructure Performance, Resiliency, and Functionality	Cost-Benefit Analysis	Effective Inspection, Maintenance, and Rehabilitation	Energy Use, Sustainability, and Environmental Impacts	Use of State-of-the-Art Technologies, Materials, Concepts, Regulations	Effective Integration: Among Sectors	Effective Integration: Among Local, Regional, and National Entities	Effective Integration: A Among Stakeholders and Disciplines	Other
Deterioration And Aging	<p>How do we move from a one-hazard-at-a-time approach to a true multi-hazard approach?</p> <p>Which multi-hazard challenges do we understand best? Least? Are we best prepared to deal with? Least prepared to deal with?</p> <p>Where have we made the most progress in recent years? Least? Why?</p>									
Natural Disasters										
Localized Accidents										
Region-Wide Failures										
System-Wide Failures										
Cascading Infrastructures Failures										
Terrorism – Explosives										
Terrorism – Cbrn										



**Aging Infrastructure Workshop Breakout 4: Infrastructure Investment**  
**Day 2: Economics, Investment, Prioritization**

Infrastructure Investment Area: Allocation factors	Existing Traditional Infrastructure Area, e.g., water, rail, electric	Enhance Management Practices, e.g., inspection, maintenance, retrofit, rehabilitation, renewal	Infrastructure investment models and tools, e.g., impacts of funding in response to aging on community economy	New technologies, materials, concepts, approaches, e.g., construction technologies, structural health solutions (sensors, continuous monitoring, decision making)	Information technology infrastructure	Tools, techniques, approaches for enhanced interaction among stakeholders	Other
Current Practices	<p>How would you allocate investment dollars among possible investment areas – by area of infrastructure? Relative investment in fixing traditional infrastructure versus investment in new tools, technologies, areas?</p> <p>Are current practices sufficient?</p> <p>What has been the impact of the stimulus package?</p> <p>Do investment priorities vary depending on the stakeholder?</p>						
Stimulus Package							
Short-Term Emphasis							
Longer-Term Emphasis							
Stakeholder Perspective							
Cascading Infrastructures Failures							
<b>Key Discussion Points</b>							
<ul style="list-style-type: none"> <li>■ Remove the politicization of funding decisions</li> <li>■ Obtain effective buy-in from general public</li> <li>■ Balance resources to provide basic services</li> <li>■ Maintain highways, bridges, and existing structures (short term)</li> <li>■ Develop new tech, deployment of new materials, and new structures (long term)</li> <li>■ Develop better condition assessment techniques using advanced technology</li> <li>■ Focus on bridges because of their multimodal and bottleneck nature</li> <li>■ Optimize the allocation of maintaining current system (long term may not be wanted)</li> <li>■ Keep current system functioning but can't keep in long run                         <ul style="list-style-type: none"> <li>Collaborative transition planning (design build perspective) with public buy-in</li> <li>Shovel-ready could be obsolete (projects that otherwise wouldn't have been executed because of scarce funding)</li> <li>Forcing new technology</li> <li>Risk is taken by the Federal Government</li> <li>Private sector does not mandate itself so it needs to be mandated from State or Federal</li> <li>Balance from private sector and public sector has shifted so we need to figure out a way to collaborate</li> </ul> </li> <li>Through incentives                         <ul style="list-style-type: none"> <li>■ No stimulus, strategic planning would be in place                                 <ul style="list-style-type: none"> <li>Current system is dynamic, optimization would be best fit by addressing cutting next generation technology</li> <li>Research for next generation technology</li> </ul> </li> <li>■ Stimulus is not right way because of its sudden nature</li> </ul> </li> </ul>							

**Aging Infrastructure Workshop Breakout 4: Infrastructure Investment**

**Day 2: Economics, Investment, Prioritization**

In light of our discussion, write in your two top-priority infrastructure investments – in the short term? In the longer term?

Investment Area: Priorities	Most important economic and social impacts – to be maximized	Longer-Term “Top Priority” (4-7 years)
Existing Traditional Infrastructure Area	<ol style="list-style-type: none"> <li>1. Maintain current system running, starting with basic services</li> <li>2. Use stimulus to jump start new technology where industries may not want to undertake the risk</li> <li>3. Improve inspection techniques that incorporate among other things structural health monitoring and non-destructive testing</li> </ol>	1. New advances in new materials
Enhanced Management Practices		2. New ways to design, conduct analysis and inspections
Infrastructure Investment Models and Tools		3. Shift design paradigm to build infrastructure with maintenance in mind (use results of FHWA-sponsored long-term bridge program, LTBP)
New Technologies, Materials, Concepts, Approaches		4. Plan for future expansion, alternative use, or demolition (for ex. Expanding GW to have a second level)
Information Technology Infrastructure		5. Use BIM style modeling for other infrastructures
Tools, Techniques, Approaches for Enhanced Interaction Among Stakeholders		6. Develops infrastructures that perform self-diagnostics and are self-healing



Aging Infrastructure Workshop Breakout 5: Economic and Social Impacts										
Day 2: Economics, Investment, Prioritization										
Infrastructure Investment Area: Economic and Social Impacts	Enhanced Protection From Man-Made Attack	Enhanced Performance, Resiliency, Functionality	Better Cost-Benefit Balance	Preventive Maintenance And Rehabilitation	More Effective Energy Use	Lessened Environmental Impact	Effective Integration – Between Sectors	Effective Integration – Local-Regional-National	Effective Integration – Among Stakeholders And Disciplines	Other
Economic Recovery Payoff	<p>What are the relative economic and social impacts of different types of infrastructure investments?</p> <p>How should we be thinking about those impacts in the early 21st century – new ways? Old ways?</p>									
Longer-Term Economic Growth										
Transformational Impact – More “Green” Economy										
Transformational Impact – Meeting 21st-Century Social Challenges	<b>Key Discussion Points</b>									
Ability To Accommodate Growth	<ul style="list-style-type: none"> <li>■ Change cost/benefit methods of infrastructure evaluation to a matrix that gives the type of information that is actually needed. Needs to include environmental, social, economic and cost/benefit aspects.</li> <li>■ Need to educate the public and keep them in the loop during the decision-making process.</li> <li>■ Educate the public on the true value of infrastructure.</li> <li>■ Need to show how improving an infrastructure in an area can attract business.</li> <li>■ Need to find out what the next generation thinks is needed in the area of infrastructure.</li> <li>■ Bring time back into civil engineering design - keep civil engineering from becoming a commodity.</li> <li>■ 1% of all project costs should be used to document the project so that its performance can be better studied in the future.</li> <li>■ Need to understand that new materials don't always work with old materials. New materials don't always work in an old system. How do we use new materials well?</li> </ul>									
Public Safety And Security										
Other										

**Aging Infrastructure Workshop Breakout 5: Economic and Social Impacts**

**Day 2: Economics, Investment, Prioritization**

In light of our discussion, write in what you consider to be the two most important economic-social impacts for judging infrastructure investments. In turn, what are the most important specific infrastructure investments to make to maximize those impacts?

Infrastructure Impacts: Priorities	Most important economic and social impacts – to be maximized	Top priority specific infrastructure investments (in light of posited most important impacts)
Economic Recovery Payoff	<ol style="list-style-type: none"> <li>1. Education – use disasters as opportunities to demonstrate the importance of infrastructures.</li> <li>2. Change the culture and attitude towards infrastructure to maintenance – need a holistic community approach to infrastructure security.</li> <li>3. Tie infrastructure to investment and competitiveness.</li> <li>4. Connect aging infrastructure to the green movement (sustainability and energy efficiency) and security</li> </ol>	<ol style="list-style-type: none"> <li>1. Build tools that tie infrastructure to investment and competitiveness.</li> <li>2. Create and validate the tools so that decision makers can make the right decision and still get re-elected.</li> <li>3. Change public attitude towards infrastructure - market infrastructure in a way that the public sees value.</li> </ol>
Longer-Term Economic Growth		
Transformational Impact – More “Green” Economy		
Transformational Impact – Meeting 21st-Century Social Challenges		
Ability To Accommodate Growth		
Public Safety And Security		



**Aging Infrastructure Workshop Breakout 6: Prioritization Methods, Risk, and Decision**  
**Day 2: Economics, Investment, Prioritization**

Infrastructure Investment Prioritization Methods: Key Stakeholders	Minimize hi-consequence failures-events (even if lower probability)	Manage hi-probability failures-events (even if lower consequences)	Enhance robustness and resiliency – overall, of critical infrastructure areas	Rely on decision-making methodologies, e.g., risk, resilience, performance-based	Transformational -- pursue 21st- century "new" infrastructure approaches – "green" infrastructure	Tools, techniques, approaches for enhanced interaction among stakeholders	Other
--	---	--	---	--	--	---	-------

Government – Local-State-Federal (Public Sector)	<p>What metrics should we be using to make decisions about infrastructure investment priorities? Should they be relative? Absolute? Short term? Long term?</p> <p>Do we need to invest in new methodologies for making choices?</p> <p>How do perceptions of priorities vary across stakeholders?</p>
Managers, Operators, Owners (Private), Vendors, Manufacturers	
Experts, Consultants, Professional Organizations	
Academic-Research Entities and Individuals	
Civil Society Groups and Entities	

	Key Discussion Points
	<p>What metrics should we be using to make infrastructure investment priorities?</p> <p>Performance requirements for metrics:</p> <ul style="list-style-type: none"> <li>■ Different metrics for different kinds of investment (e.g., retrofit v. new design)</li> <li>■ There may be several metrics: no single evaluation system may be sufficient or practical (e.g., NBI uses condition rating, serviceability rating; NY State Bridge management uses structural condition, potential hazards, and vulnerability)</li> <li>■ Resiliency: Need to derive consensus definition of (2-4 Rs)</li> <li>■ Differentiate between disaster recovery or business continuity approach to assets – e.g., mission critical networks (resiliency of processes v. of structure); quality of procedures in place to shut down and bring back service in orderly fashion . . .</li> <li>■ Consider weighting measures for interdependent assets</li> <li>■ Functional/impending obsolescence may be a weighting/ranking factor</li> <li>■ Metrics, codes and standards may not be applicable across whole nation; may need to adapt to regional/sector-specific issues</li> <li>■ Metric will need to be "living," flexible and adaptable</li> <li>■ Metric must be standardized</li> </ul>

## Aging Infrastructure Workshop Breakout 6: Prioritization Methods, Risk, and Decision

### Day 2: Economics, Investment, Prioritization

Infrastructure Investment Prioritization Methods: Key Stakeholders	Minimize hi-consequence failures-events (even if lower probability)	Manage hi-probability failures-events (even if lower consequences)	Enhance robustness and resiliency – overall, of critical infrastructure areas	Rely on decision-making methodologies, e.g., risk, resiliency, performance-based	Transformational -- pursue 21st-century "new" infrastructure approaches – "green" infrastructure	Tools, techniques, approaches for enhanced interaction among stakeholders	Other
Government – Local-State-Federal (Public Sector)	<b>Key Discussion Points</b>						
Managers, Operators, Owners (Private), Vendors, Manufacturers	<p>Suggestions for metrics (using resiliency as example):</p> <ul style="list-style-type: none"> <li>■ 4 Rs, but needs standardization of definitions</li> <li>■ Resiliency could be defined in terms of length of time until service restored (DoS x Ndays)</li> <li>■ Matrix of "critical" and "vulnerability" e.g., critical 0, vulnerable 0 = no investment; critical 1, vulnerable 1 = lots of investment; critical 1, vulnerable 0 = some investment</li> <li>■ Probability of event</li> <li>■ Identifying single points of failure should be part of metric</li> <li>■ Hazard = Vulnerability x Exposure x Consequence [std engineering definition]</li> <li>■ Measure consequence as loss of asset or denial of service, and should be based on public health/safety, socioeconomic impact, &amp; environmental impact</li> <li>■ Financial value/cost benefit analysis approach: general meaning of "investment" and returns on could be basis for metric</li> <li>■ Consult engineering/network [?] 'reliability experts' on their network design approaches to help develop optimal 'reliability' metric</li> <li>■ Reliability analysis – no reliability analysis available for infrastructure needs so would need R&amp;D to figure out how to apply</li> <li>■ Probabilistic/reliability analysis not only when not enough info! Also good for increasing data</li> <li>■ Bayesian network analysis with many nodes for resilience and sensitivity analyses; such probabilistic tools especially good for increasing data</li> <li>■ DHS IP has successfully developed and applied risk analysis tools that can be adapted</li> <li>■ Use current national code standards – based on rigorous engineering criteria</li> </ul>						
Experts, Consultants, Professional Organizations							
Academic-Research Entities and Individuals							
Civil Society Groups and Entities							



Aging Infrastructure Workshop Breakout 6: Prioritization Methods, Risk, and Decision		
Day 2: Economics, Investment, Prioritization		
In light of our discussion, write in what you consider to be the two most important “tests” for making judgments about infrastructure investment priorities? Short term? Longer term?		
Prioritization Methods: Priorities	Short-Term “Top Priority” (1-3 years)	Longer-Term “Top Priority” (4-7 years)
Minimize high-consequence failures-events (even if lower probability)	How can we convince the private sector to invest its money in improving its infrastructure?	
Manage high-probability failures-events (even if lower consequences)	Role of private sector in adopting metric:	
Enhance robustness and resiliency – overall, of critical infrastructure areas	DHS can help private sector develop metrics or DHS can provide metrics and can strongly recommend to private sector	
Rely on decision-making methodologies, e.g., risk, resilience, performance-based	Will depend on standardization, perceived rigor and usefulness of metric(s) – may need to seek some consensus with private sector on metrics	
Transformation impact -- pursue 21st-century “new” infrastructure approaches – “green” infrastructure		
Monetary – something for every area within absolute funding limit		
Political – something for every State		

## Aging Infrastructure Workshop Breakout 7: Infrastructure of the Future

### Day 3: Infrastructure of the Future

Infrastructure Investment Prioritization Methods: Key Stakeholders	Robust, resilient, adaptive, and highly functional	Reduced vulnerability to terrorist threats	Resistant to unexpected future challenges, e.g., multi-hazard, cascading effects, climate change	"Green" infrastructure – sound for environment	"Smart" infrastructure – self-monitoring, self-regulating, self-assessing, self-healing	Financially sustainable	Politically sustainable	Other
Government – Local-State-Federal (Public Sector)	What should be our time horizon in planning for future infrastructure?							
Managers, Operators, Owners (Private), Vendors, Manufacturers	What should the infrastructure of the future look like – key features, characteristics, defining elements?							
Experts, Consultants, Professional Organizations	Would all the stakeholders agree? How can we get there from here?							
Academic-Research Entities and Individuals								
Civil Society Groups and Entitie	<b>Key Discussion Points</b>							
	<ul style="list-style-type: none"> <li>■ Build for renewal and ease of replacement into original design.</li> <li>■ Need to be much more modular looking forward – need infrastructure that is inexpensive and temporary, has mid-life service, and longer lasting =&gt; need to have a menu of options.</li> <li>■ nrastructure that has a lower level of maintenance, need to minimize in design in the forward</li> <li>■ Better awareness of lifetime maintenance needs.</li> <li>■ Key Features: <ul style="list-style-type: none"> <li>Infrastructure should serve many goals and objectives (sustainability, serviceability, security) – there are connection points. That is what we need to focus on.</li> <li>Recyclable materials, human health issues with new materials.</li> <li>Multifunctionality – (what effects would decisions have on other systems).</li> <li>Need standards, objectives and key metrics (environmental, social-health-safety) – need a holistic approach.</li> </ul> </li> <li>■ Need to build funding to maintain and replace the infrastructure we build today.</li> <li>■ There may some short-term sacrifices for owner/operators to yield long-term dividends. Need to also focus on all-hazards approach.</li> <li>■ We need a specific list of priorities, more than the ASCE report card. How do we go from a "D" to a "B"?</li> <li>■ Need to focus on the future demands (how much water?, etc), then look at ways of providing it that fit the standards, objectives and key metrics.</li> <li>■ Need a national initiative with buy-in from the public – we need proper public outreach to gain support =&gt; Risk communication.</li> <li>■ Need an attractive vision. Government at all levels needs to put together this story – make a business case as to how we will create this infrastructure of the future. We will need a public campaign. To accomplish this we need to start with the youngest generation.</li> <li>■ Need to deal with political reality.</li> <li>■ Need to consider population trends, not just population growth (where is the growth).</li> <li>■ Need national leadership for replacement vehicle to generate funding</li> </ul>							





Aging Infrastructure Workshop Breakout 7: Infrastructure of the Future		
Day 3: Infrastructure of the Future		
In light of our discussion, write in what you consider to be the two most important characteristics of infrastructure of the future. Write in what you consider to be the two most important infrastructure investments to pursue that infrastructure		
	Top priority characteristics of “infrastructure of the future”	Longer-Term “Top Priority” (4-7 years)
Robust, Resilient, Adaptive, And Highly Functional	1. Flexibility – needs to provide services, be sustainable, accommodate future capacity 2. Maintainability 3. Inspectability and access to power 4. Need tools to allow rapid assessment of infrastructure 5. Sustainability 6. Need to make new infrastructure visible – connect with the public 7. Designing infrastructure that has high social capital – will help to increase resiliency	8. Pilot projects to showcase new designs, materials to convince owners to not repeat existing designs 9. Need funding with “strings attached” to mandate new approaches 10. New ways of financing need to be explored – we need some creativity
Reduced Vulnerability To Terrorist Threats		
Resistant To Future Challenges, E.G., Multi-Hazard, Cascading Effects, Climate Change, Safety		
“Green” Infrastructure – Sound For Environment		
“Smart” Infrastructure – Self-Monitoring, Self-Regulating, Self-Assessing, Self-Healing		
Financially Sustainable		
Politically Sustainable		





