



of the National Institute of Building Sciences

*Program on
Improved Seismic Safety
Provisions*

2003 Edition

Note: The June 6, 2006 ERRATA has been incorporated into this document.

NEHRP RECOMMENDED PROVISIONS FOR SEISMIC REGULATIONS FOR NEW BUILDINGS AND OTHER STRUCTURES (FEMA 450)

Part 1: Provisions

The **Building Seismic Safety Council (BSSC)** was established in 1979 under the auspices of the National Institute of Building Sciences as an entirely new type of instrument for dealing with the complex regulatory, technical, social, and economic issues involved in developing and promulgating building earthquake hazard mitigation regulatory provisions that are national in scope. By bringing together in the BSSC all of the needed expertise and all relevant public and private interests, it was believed that issues related to the seismic safety of the built environment could be resolved and jurisdictional problems overcome through authoritative guidance and assistance backed by a broad consensus.

The BSSC is an independent, voluntary membership body representing a wide variety of building community interests. Its fundamental purpose is to enhance public safety by providing a national forum that fosters improved seismic safety provisions for use by the building community in the planning, design, construction, regulation, and utilization of buildings.

See the back of the *Commentary* volume for a full description of BSSC activities.

2003 BSSC BOARD OF DIRECTION

Chairman	Charles Thornton, Chairman/Principal, Thornton-Tomasetti Group, Inc., New York, New York
Vice Chairman	David Bonneville, Degenkolb Engineers, San Francisco, California
Secretary	Charles Carter, Chief Structural Engineer, American Institute of Steel Construction, Chicago, Illinois
Ex-Officio	William W. Stewart, Stewart-Schaberg Architects, Clayton, Missouri (representing the American Institute of Architects)
Members	J. Gregg Borchelt, Vice President, Brick Industry Association, Reston, Virginia Edwin Dean, Nishkian Dean, Portland, Oregon Bradford K. Douglas, Director of Engineering, American Forest and Paper Association, Washington, D.C. Henry Green, Executive Director, Bureau of Construction Codes and Fire Safety, State of Michigan, Department of Labor and Economic Growth, Lansing, Michigan (representing the National Institute of Building Sciences) H.S. Lew, Senior Research Engineer, National Institute of Standards and Technology, Gaithersburg, Maryland (representing Interagency Committee on Seismic Safety in Construction) Joseph Messersmith, Coordinating Manager, Regional Code Services, Portland Cement Association, Rockville, Virginia (representing the Portland Cement Association) Jim Rinner, Project Manager II, Kitchell CEM, Sacramento, California James Rossberg, Manager, Technical Activities for the Structural Engineering Institute, American Society of Civil Engineers, Reston Virginia Jeffery Sciadone, Associate Director, of Engineering, Institute of Business and Home Safety, Tampa, Florida W. Lee Shoemaker, Director, Engineering and Research, Metal Building Manufacturers Association, Cleveland, Ohio Howard Simpson, Simpson Gumpertz and Heger, Arlington, Massachusetts (representing National Council of Structural Engineers Associations) Charles A. Spitz, Architect/Planner/Code Consultant, Wall New Jersey (representing the American Institute of Architects)
BSSC STAFF	Claret M. Heider, Vice President for BSSC Programs Bernard F. Murphy, Director, Special Projects Carita Tanner, Communications/Public Relations Manager Patricia Blasi, Administrative Assistant

NEHRP RECOMMENDED PROVISIONS
(National Earthquake Hazards Reduction Program)
FOR SEISMIC REGULATIONS
FOR NEW BUILDINGS AND
OTHER STRUCTURES (FEMA 450)

2003 EDITION

Part 1: PROVISIONS

Prepared by the
Building Seismic Safety Council
for the
Federal Emergency Management Agency

BUILDING SEISMIC SAFETY COUNCIL
NATIONAL INSTITUTE OF BUILDING SCIENCES
Washington, D.C.
2004

NOTICE: Any opinions, findings, conclusions, or recommendations expressed in this publication do not necessarily reflect the views of the Federal Emergency Management Agency. Additionally, neither FEMA nor any of its employees make any warranty, expressed or implied, nor assume any legal liability or responsibility for the accuracy, completeness, or usefulness of any information, product, or process included in this publication.

This report was prepared under Contract EMW-2001-CO-0269 between the Federal Emergency Management Agency and the National Institute of Building Sciences.

Building Seismic Safety Council activities and products are described at the end of this report. For further information, see the Council's website (www.bssconline.org) or contact the Building Seismic Safety Council, 1090 Vermont Avenue, N.W., Suite 700, Washington, D.C. 20005; phone 202-289-7800; fax 202-289-1092; e-mail bssc@nibs.org.

Copies of this report on CD Rom may be obtained from the FEMA Publication Distribution Facility at 1-800-480-2520. Limited paper copies also will be available. The report can also be downloaded in pdf form from the BSSC website at www.bssconline.org.

The National Institute of Building Sciences and its Building Seismic Safety Council caution users of these *Provisions* documents to be alert to patent and copyright concerns especially when applying prescriptive requirements

PREFACE

One of the goals of the Department of Homeland Security's Federal Emergency Management Agency (FEMA) and the National Earthquake Hazards Reduction Program (NEHRP) is to encourage design and building practices that address the earthquake hazard and minimize the resulting risk of damage and injury. Publication of the 2003 edition of the *NEHRP Recommended Provisions for Seismic Regulation of New Buildings and Other Structures* and its *Commentary* is a fitting end to the 25th year of the NEHRP and reaffirms FEMA's ongoing support to improve the seismic safety of construction in this country. Its publication marks the sixth edition in an ongoing series of updating of both the *NEHRP Recommended Provisions* and several complementary publications. FEMA was proud to sponsor the Building Seismic Safety Council for this project and we encourage the widespread dissemination and voluntary use of this state-of-the-art consensus resource document.

The 2003 edition of the *NEHRP Recommended Provisions* contains several significant changes, including: a reformatting to improve its usability; introduction of a simplified design procedure, an updating of the seismic design maps and how they are presented; a modification in the redundancy factor; the addition of ultimate strength design provisions for foundations; the addition of several new structural systems, including buckling restrained braced frames and steel plate shear walls; structures with damping systems has been moved from an appendix to a new chapter; and inclusion of new or updated material industry reference standards for steel, concrete, masonry, and wood.

The above changes are but a few of the 138 ballots submitted to the BSSC member organizations. The number of changes continues to be significant and is a testament to the level of attention being paid to this publication. This is due in large part to the role that the *NEHRP Recommended Provisions* has in the seismic requirements in the ASCE-7 Standard *Minimum Design Loads for Buildings and Other Structures* as well as both the *International Building Code* and *NFPA 5000 Code*. FEMA welcomes this increased scrutiny and the chance to work with these code organizations.

Looking ahead, FEMA is contracting with BSSC for the update process that will lead to the 2008 edition of the *NEHRP Recommended Provisions*. As is evidenced by the proposed date, this next update cycle will be expanded to a five-year effort to conclude in time to input into the next update of the ASCE-7 standard. This update will include referencing of the ASCE-7 standard to avoid duplication of effort and a significant update and revision to the *Commentary* along with the normal update of current material and the inclusion of new, state-of-the-art seismic design research results.

Finally, FEMA wishes to express its deepest gratitude for the significant efforts of the over 200 volunteer experts as well as the BSSC Board of Directors and staff who made possible the 2003 *NEHRP Provisions* documents. It is truly their efforts that make these publications a reality. Americans unfortunate enough to experience the earthquakes that will inevitably occur in this country will owe much, perhaps even their very lives, to the contributions and dedication of these individuals to the seismic safety of new buildings. Without the dedication and hard work of these men and women, this document and all it represents with respect to earthquake risk mitigation would not have been possible.

*Department of Homeland Security/
Federal Emergency Management Agency*

INTRODUCTION and ACKNOWLEDGEMENTS

Since its creation in 1978, the National Earthquake Hazard Reduction Program (NEHRP) has provided a framework for efforts to reduce the risk from earthquakes. The Building Seismic Safety Council (BSSC) is extremely proud to have been selected by the Federal Emergency Management Agency (FEMA), the lead NEHRP agency, to play a role under NEHRP in improving the seismic resistance of the built environment. Further, the BSSC is pleased to mark the occasion of its twenty-fifth anniversary with delivery to FEMA of the consensus-approved 2003 *NEHRP Recommended Provisions for Seismic Regulations for New Buildings and other Structures*, the seventh edition of this landmark publication. The *Provisions* and its accompanying *Commentary* have developed over the past quarter century into widely available, trusted, state-of-the-art seismic design resource documents with requirements that have been adapted for use in nation's model building codes and standards.

Work on the 2003 *Provisions* began in September 2001 when NIBS entered into a contract with FEMA for initiation of the BSSC 2003 *Provisions* update effort. In mid-2001, the BSSC member organization representatives and alternate representatives and the BSSC Board of Direction were asked to identify individuals to serve on the 2003 Provisions Update Committee (PUC) and its Technical Subcommittees (TSs).

The 2003 PUC and its 13 Technical Subcommittees (TS) were then established and addressed the following topics during the update effort: design criteria and analysis, foundations and geotechnical considerations, cast-in-place/precast concrete structures, masonry structures, steel structures, wood structures, mechanical-electrical systems and building equipment and architectural elements, quality assurance, low rise and residential structures, composite steel and concrete structures, energy dissipation and base isolation, and nonbuilding structures.

Early in the update effort, a series of editorial/organizational changes were made to the 2000 version of the *Provisions* to improve the document's usability and eliminate inconsistencies and duplications that had crept in over the years; this edited document was submitted to the BSSC membership for ballot in October 2001 and was then adopted as the document to which further update changes would be proposed. All draft TS and PUC proposals for change were finalized in June 2003 and approved by the BSSC Board of Direction for balloting by the BSSC member organizations. Because of time limitations, there would be no second ballot; therefore, the BSSC Board authorized the PUC to resolve, to the extent possible, comments submitted by the membership and to defer for reconsideration during the next update cycle any comments that could not be resolved in the limited time available.

Of the 138 proposals submitted to the members for ballot, 137 received the required two-thirds affirmative vote. Of those, 3 were withdrawn for reconsideration during the next update cycle and 83 required some revision in response to comments. A summary of the results of the ballot and comment resolution process are available from the BSSC upon request and will be posted on the BSSC website (www.bssconline.org).

As in the past, the 2003 *Provisions* would not now be available without the expertise, dedication, and countless hours of effort of the more than 200 dedicated volunteers who participated in the update process. The American people benefit immeasurably from their commitment to improving the seismic-

resistance of the nation's buildings. These seismic design professionals are identified in Appendix B of the *Provisions* volume with list of BSSC Board members and member organizations.

I would like to acknowledge a few individuals and groups who deserve special thanks for their contributions to this effort. As Chairman of the BSSC Board of Direction, it is my pleasure to express heartfelt appreciation to the members of the BSSC Provisions Update Committee, especially Chairman Ronald Hamburger, and to Michael Mahoney, the FEMA Project Officer. Special thanks also are due to the BSSC staff who work untiringly behind the scenes to support all the groups mentioned above and who bring the finished product forward for acceptance. Finally, I wish to thank the members of the BSSC Board of Direction who recognize the importance of this effort and provided sage advice throughout the update cycle. We are all proud of the *2003 NEHRP Recommended Provisions* and it is my pleasure to introduce them.

Charles Thornton
Chairman, BSSC Board of Direction 2001-2003

CONTENTS

Chapter 1 GENERAL PROVISIONS	1
1.1 GENERAL.....	1
1.1.1 Purpose.....	1
1.1.2 Scope and application	1
1.1.3 References.....	2
1.1.4 Definitions	3
1.1.5 Notation	3
1.2 SEISMIC USE GROUPS	4
1.2.1 Seismic Use Group III	4
1.2.2 Seismic Use Group II.....	4
1.2.3 Seismic Use Group I.....	4
1.2.4 Multiple use	4
1.2.5 Seismic Use Group III structure access protection	5
1.3 OCCUPANCY IMPORTANCE FACTOR.....	5
1.4 SEISMIC DESIGN CATEGORY	5
1.4.1 Determination of Seismic Design Category.....	5
1.4.2 Site limitation for Seismic Design Categories E and F.....	6
1.5 SEISMIC DESIGN CATEGORY A	6
1.5.1 Lateral forces	6
1.5.2 Connections	7
1.5.3 Anchorage of concrete or masonry walls.....	7
1.5.4 Tanks assigned to Seismic Use Group III.....	7
Chapter 2 QUALITY ASSURANCE	9
2.1 GENERAL	9
2.1.1 Scope.....	9
2.1.2 References.....	9
2.1.3 Definitions	9
2.1.4 Notation	11
2.2 GENERAL REQUIREMENTS.....	11
2.2.1 Details of quality assurance plan	11
2.2.2 Contractor responsibility.....	12
2.3 SPECIAL INSPECTION.....	12
2.3.1 Piers, piles, and caissons	12
2.3.2 Reinforcing steel	12
2.3.3 Structural concrete	12
2.3.4 Prestressed concrete	12
2.3.5 Structural masonry	12
2.3.6 Structural steel	12
2.3.7 Structural wood.....	13
2.3.8 Cold-formed steel	13
2.3.9 Architectural components	13
2.3.10 Mechanical and electrical components	13
2.3.11 Seismic isolation systems	14
2.4 TESTING	14
2.4.1 Reinforcing and prestressing steel	14

2.4.2 Structural concrete	14
2.4.3 Structural masonry	14
2.4.4 Structural steel	14
2.4.5 Mechanical and electrical equipment.....	14
2.4.6 Seismically isolated structures	14
2.5 STRUCTURAL OBSERVATIONS.....	15
2.6 REPORTING AND COMPLIANCE PROCEDURES	15
 Chapter 3 GROUND MOTION.....	 17
3.1 GENERAL.....	17
3.1.1 Scope.....	17
3.1.2 References	17
3.1.3 Definitions	17
3.1.4 Notation	17
3.2 GENERAL REQUIREMENTS.....	19
3.2.1 Site class	19
3.2.2 Procedure selection	19
3.3 GENERAL PROCEDURE.....	19
3.3.1 Mapped acceleration parameters.....	19
3.3.2 Site coefficients and adjusted acceleration parameters.....	19
3.3.3 Design acceleration parameters	38
3.3.4 Design response spectrum.....	38
3.4 SITE SPECIFIC PROCEDURE.....	46
3.4.1 Probabilistic maximum considered earthquake	46
3.4.2 Deterministic maximum considered earthquake.....	46
3.4.3 Site-specific maximum considered earthquake	46
3.4.4 Design response spectrum.....	47
3.5 SITE CLASSIFICATION FOR SEISMIC DESIGN	47
3.5.1 Site class definitions	47
3.5.2 Steps for classifying a site.....	49
 Chapter 4 STRUCTURAL DESIGN CRITERIA.....	 51
4.1 GENERAL.....	51
4.1.1 Scope.....	51
4.1.2 References	51
4.1.3 Definitions	51
4.1.4 Notation	53
4.2 GENERAL REQUIREMENTS.....	54
4.2.1 Design basis	54
4.2.2 Combination of load effects.....	54
4.3 SEISMIC-FORCE-RESISTING SYSTEM.....	55
4.3.1 Selection and limitations.....	55
4.3.2 Configuration	62
4.3.3 Redundancy	65
4.4 STRUCTURAL ANALYSIS	66
4.4.1 Procedure selection	66
4.4.2 Application of loading	67
4.5 DEFORMATION REQUIREMENTS	68
4.5.1 Deflection and drift limits	68
4.5.2 Seismic Design Categories B and C	68
4.5.3 Seismic Design Categories D, E, and F	68

4.6 DESIGN AND DETAILING REQUIREMENTS	69
4.6.1 Seismic design Category B	69
4.6.2 Seismic design Category C	70
4.6.3 Seismic Design Category D, E, and F.....	71
ALTERNATIVE SIMPLIFIED CHAPTER 4.....	73
Chapter 5 STRUCTURAL ANALYSIS PROCEDURES	83
5.1 GENERAL.....	83
5.1.1 Scope.....	83
5.1.2 Definitions	83
5.1.3 Notation	84
5.2 EQUIVALENT LATERAL FORCE PROCEDURE	86
5.2.1 Seismic base shear	86
5.2.2 Period determination.....	88
5.2.3 Vertical distribution of seismic forces	89
5.2.4 Horizontal shear distribution.....	90
5.2.5 Overturning.....	91
5.2.6 Drift determination and P-delta effects.....	91
5.3 RESPONSE SPECTRUM PROCEDURE.....	92
5.3.1 Modeling.....	92
5.3.2 Modes.....	92
5.3.3 Modal properties	92
5.3.4 Modal base shear.....	92
5.3.5 Modal forces, deflections and drifts.....	94
5.3.6 Modal story shears and moments.....	94
5.3.7 Design values	94
5.3.8 Horizontal shear distribution.....	95
5.3.9 Foundation overturning.....	95
5.3.10 P-delta effects.....	95
5.4 LINEAR RESPONSE HISTORY PROCEDURE.....	95
5.4.1 Modeling.....	95
5.4.2 Ground motion	95
5.4.3 Response parameters.....	96
5.5 NONLINEAR RESPONSE HISTORY PROCEDURE	96
5.5.1 Modeling.....	96
5.5.2 Ground motion and other loading	97
5.5.3 Response parameters.....	97
5.5.4 Design review	97
5.6 SOIL-STRUCTURE INTERACTION EFFECTS	98
5.6.1 General.....	98
5.6.2 Equivalent lateral force procedure	98
5.6.3 Response spectrum procedure.....	102
APPENDIX to Chapter 5, NONLINEAR STATIC PROCEDURE	105
Chapter 6, ARCHITECTURAL, MECHANICAL, AND ELECTRICAL COMPONENT DESIGN REQUIREMENTS	111
6.1 GENERAL.....	111
6.1.1 Scope.....	111
6.1.2 References	111

6.1.3	Definitions	113
6.1.4	Notation	114
6.2	GENERAL DESIGN REQUIREMENTS	115
6.2.1	Seismic Design Category	115
6.2.2	Component importance factor.....	115
6.2.3	Consequential damage	116
6.2.4	Flexibility.....	116
6.2.5	Component force transfer	116
6.2.6	Seismic forces	116
6.2.7	Seismic relative displacements	117
6.2.8	Component anchorage	117
6.2.9	Construction documents.....	118
6.3	ARCHITECTURAL COMPONENTS	118
6.3.1	Forces and displacements	119
6.3.2	Exterior nonstructural wall elements and connections.....	119
6.3.3	Out-of-plane bending	120
6.3.4	Suspended ceilings.....	120
6.3.5	Access floors.....	121
6.3.6	Partitions	121
6.3.7	General.....	122
6.3.8	Seismic drift limits for glass components	122
6.4	MECHANICAL AND ELECTRICAL COMPONENTS.....	122
6.4.1	Component period.....	124
6.4.2	Mechanical components.....	124
6.4.3	Electrical components.....	124
6.4.4	Supports and attachments	125
6.4.5	Utility and service lines	126
6.4.6	HVAC ductwork	126
6.4.7	Piping systems	126
6.4.8	Boilers and pressure vessels.....	127
6.4.9	Elevators	127
Appendix to Chapter 6, ALTERNATIVE PROVISIONS FOR THE DESIGN OF PIPING SYSTEMS.....		129
Chapter 7 FOUNDATION DESIGN REQUIREMENTS.....		133
7.1	GENERAL.....	133
7.1.1	Scope.....	133
7.1.2	References.....	133
7.1.3	Definitions	133
7.1.4	Notation	133
7.2	GENERAL DESIGN REQUIREMENTS	134
7.2.1	Foundation components	134
7.2.2	Soil capacities	134
7.2.3	Foundation load-deformation characteristics.....	134
7.3	SEISMIC DESIGN CATEGORY B.....	134
7.4	SEISMIC DESIGN CATEGORY C.....	134
7.4.1	Investigation.....	134
7.4.2	Pole-type structures.....	135
7.4.3	Foundation ties.....	135
7.4.4	Special pile requirements	135

9.4 SEISMIC DESIGN CATEGORY C.....	164
9.4.1 Classification of shear walls	164
9.4.2 Plain concrete.....	164
9.5 SEISMIC DESIGN CATEGORIES D, E, AND F.....	165
9.6 ACCEPTANCE CRITERIA FOR SPECIAL PRECAST STRUCTURAL WALLS BASED ON VALIDATION TESTING	165
9.6.1 Notation	165
9.6.2 Definitions	165
9.6.3 Scope and general requirements	166
9.6.4 Design procedure	166
9.6.5 Test modules	167
9.6.6 Testing agency	167
9.6.7 Test method.....	167
9.6.8 Test report	168
9.6.9 Test module acceptance criteria.....	169
9.6.10 Reference	169
Appendix to Chapter 9, UNTOPPED PRECAST DIAPHRAGMS	171
Chapter 10, COMPOSITE STEEL AND CONCRETE STRUCTURE DESIGN REQUIREMENTS.....	175
10.1 GENERAL	175
10.1.1 Scope.....	175
10.1.2 References.....	175
10.1.3 Definitions	175
10.1.4 Notation	175
10.2 GENERAL DESIGN REQUIREMENTS	175
10.3 SEISMIC DESIGN CATEGORIES B AND C	175
10.4 SEISMIC DESIGN CATEGORIES D, E, AND F.....	175
10.5 MODIFICATIONS TO AISC SEISMIC, PART II.....	175
10.5.1 Changes to nomenclature	175
10.5.2 Changes to definitions in the AISC Glossary	176
10.5.3 Changes to section 1-Scope	176
10.5.4 Changes to Section 2 – Referenced Specifications, Codes and Standards.....	176
10.5.5 Changes to Section 3 – Seismic Design Categories.....	176
10.5.6 Changes to Section 4 – Loads, Load Combinations and Nominal Strengths	176
10.5.7 Changes to Section 5.2 – Concrete and steel reinforcement.....	176
10.5.8 Changes to Section 6.3 – Composite Beams.....	176
10.5.9 Changes to Section 6.4 – Reinforced-Concrete-Encased Composite Columns.....	176
10.5.10 Changes to Section 6.4a – Ordinary Seismic System Requirements	177
10.5.11 Changes to Section 6.5 – Concrete-Filled Composite Columns	177
10.5.12 Changes to Section 6.5a – Concrete-Filled Composite Columns	177
10.5.13 Changes to Section 7.3 – Nominal Strength of Connections	178
10.5.14 Changes to Section 8.2 – Columns	179
10.5.15 Changes to Section 8.3 – Composite Beams	179
10.5.16 Changes to Section 8.4 – Partially Restrained (PR) Moment Connections	179

10.5.17 Changes to Section 9.3 – Beams.....	179
10.5.18 Changes to Section 9.4 – Moment Connections	179
10.5.19 Changes to Section 9.5 – Column-Beam Moment Ratio	180
10.5.20 Changes to Section 10.2 – Columns	180
10.5.21 Changes to Section 10.4 – Moment Connections	180
10.5.22 Changes to Section 11.4 – Moment Connections	180
10.5.23 Changes to Section 12.4 – Braces.....	180
10.5.24 Changes Title for Section 15.3.....	181
10.5.25 Changes Title for Section 16.3	181
10.5.26 Add New Section 15.4.....	181
10.5.27 Add New Section 16.4	181
Chapter 11 MASONRY STRUCTURE DESIGN REQUIREMENTS	183
11.1 GENERAL.....	183
11.1.1 Scope.....	183
11.1.2 References	183
11.2 GENERAL DESIGN REQUIREMENTS	183
11.2.1 Classification of shear walls	183
11.2.2 Modifications to ACI 530/ADCE 5/TMS 402 and ACI 530.1/ASCE 5/TMS 602.....	184
11.3 SPECIAL MOMENT FRAMES OF MASONRY	187
11.3.1 Calculation of required strength.....	187
11.3.2 Flexural yielding	187
11.3.3 Materials	187
11.3.4 Reinforcement.....	187
11.3.5 Beams.....	188
11.3.6 Columns	188
11.3.7 Beam-column intersections.....	189
11.4 GLASS-UNIT MASONRY AND MASONRY VENEER.....	192
11.4.1 Design lateral forces and displacements	191
11.4.2 Glass-unit masonry design	191
11.4.3 Masonry veneer design	191
11.5 PRESTRESSED MASONRY	191
11.5.1	191
Chapter 12 WOOD STRUCTURE DESIGN REQUIREMENTS	193
12.1 GENERAL.....	193
12.1.1 Scope.....	193
12.1.2 References.....	193
12.1.3 Definitions	194
12.1.4 Notation	195
12.2 DESIGN METHODS	195
12.2.1 Seismic Design Categories B, C, and D.....	195
12.2.2 Seismic Design Categories E and F	195
12.2.3 Modifications to AF&PA SDPWS for Seismic Design Categories B, C, and D	195
12.2.4 Modifications to AF&PA SDPWS for Seismic Design Categories E, and F.....	198
12.3 GENERAL DESIGN REQUIREMENTS FOR ENGINEERED WOOD CONSTRUCTION	203
12.3.1 Framing.....	203

12.4 CONVENTIONAL LIGHT-FRAME CONSTRUCTION	203
12.4.1 Limitations	203
12.4.2 Braced walls.....	209
12.4.3 Detailing requirements.....	211
 Chapter 13 SEISMICALLY ISOLATED STRUCTURE DESIGN	
REQUIREMENTS	215
13.1 GENERAL	215
13.1.1 Scope.....	215
13.1.2 Definitions	215
13.1.3 Notation	216
13.2 GENERAL DESIGN REQUIREMENTS	218
13.2.1 Occupancy importance factor	218
13.2.2 Configuration	218
13.2.3 Ground motion.....	218
13.2.4 Procedure selection.....	219
13.2.5 Isolation system	220
13.2.6 Structural system.....	221
13.2.7 Elements of structures and nonstructural components.....	221
13.3 EQUIVALENT LATERAL FORCE PROCEDURE	222
13.3.1 Deformational characteristics of the isolation system	222
13.3.2 Minimum lateral displacements.....	222
13.3.3 Minimum distribution of forces	224
13.3.4 Vertical distribution of forces	225
13.3.5 Drift limits.....	225
13.4 DYNAMIC PROCEDURES	225
13.4.1 Modeling.....	225
13.4.2 Description of procedures	226
13.4.3 Minimum lateral displacements and forces	227
13.4.4 Drift limits.....	228
13.5 DESIGN REVIEW	228
13.6 TESTING.....	228
13.6.1 Prototype tests.....	228
13.6.2 Determination of force-deflection characteristics.....	230
13.6.3 Test specimen adequacy	230
13.6.4 Design properties of the isolation system	230
 Chapter 14 NONBUILDING STRUCTURE DESIGN REQUIREMENTS.....	233
14.1 GENERAL.....	233
14.1.1 Scope.....	233
14.1.2 References.....	233
14.1.3 Definitions	234
14.1.4 Notation	235
14.1.5 Nonbuilding structures supported by other structures	237
14.2 GENERAL DESIGN REQUIREMENTS	237
14.2.1 Seismic Use Groups and importance factors	237
14.2.2 Ground motion	238
14.2.3 Design basis	238
14.2.4 Seismic-force-resisting system selection and limitations	238
14.2.5 Structural analysis procedure selection	241
14.2.6 Seismic weight.....	241

14.2.7 Rigid nonbuilding structures.....	241
14.2.8 Minimum base shear	241
14.2.9 Fundamental period	241
14.2.10 Vertical distribution of seismic forces	242
14.2.11 Deformation requirements	242
14.2.12 Nonbuilding structure classification	242
14.3 NONBUILDING STRUCTURES SIMILAR TO BUILDINGS	242
14.3.1 Electrical power generating facilities.....	242
14.3.2 Structural towers for tanks and vessels	242
14.3.3 Piers and wharves	243
14.3.4 Pipe racks	243
14.3.5 Steel storage tanks.....	243
14.4 NONBUILDING STRUCTURES NOT SIMILAR TO BUILDINGS.....	244
14.4.1 General.....	244
14.4.2 Earth retaining structures	244
14.4.3 Stacks and chimneys	244
14.4.4 Amusement structures.....	244
14.4.5 Special hydraulic structures	245
14.4.6 Secondary containment systems	245
14.4.7 Tanks and vessels.....	245
Appendix to Chapter 14 OTHER NONBUILDING STRUCTURES	261
Chapter 15 STRUCTURES WITH DAMPING SYSTEMS	263
15.1 GENERAL.....	263
15.1.1 Scope.....	263
15.1.2 Definitions	263
15.1.3 Notation	264
15.2 GENERAL DESIGN REQUIREMENTS	267
15.2.1 Seismic Design Category A	267
15.2.2 System requirements.....	268
15.2.3 Ground motion	278
15.2.4 Procedure selection	269
15.2.5 Damping system.....	269
15.3 NONLINEAR PROCEDURES	270
15.3.1 Nonlinear response history procedure.....	270
15.3.2 Nonlinear static procedure	271
15.4 RESPONSE SPECTRUM PROCEDURE.....	271
15.4.1 Modeling.....	271
15.4.2 Seismic-force-resisting system	271
15.4.3 Damping system	273
15.5 EQUIVALENT LATERAL FORCE PROCEDURE	274
15.5.1 Modeling.....	274
15.5.2 Seismic-force-resisting system	274
15.5.3 Damping system	277
15.6 DAMPED RESPONSE MODIFICATION	279
15.6.1 Damping coefficient	279
15.6.2 Effective damping	279
15.6.3 Effective ductility demand	281
15.6.4 Maximum effective ductility demand	282
15.7 SEISMIC LOAD CONDITIONS AND ACCEPTANCE CRITERIA	282

15.7.1 Nonlinear procedures	282
15.7.2 Seismic-force-resisting system	283
15.7.3 Damping system.....	283
15.8 DESIGN REVIEW	286
15.9 TESTING.....	286
15.9.1 Prototype tests.....	286
15.9.2 Production testing	288
Appendix A DIFFERENCES BETWEEN THE 2000 AND THE 2003 EDITIONS OF THE <i>NEHRP RECOMMENDED PROVISIONS</i>	289
Appendix B PARTICIPANTS IN THE BSSC 2003 <i>PROVISIONS</i> UPDATE PROGRAM.....	309

Chapter 1

GENERAL PROVISIONS

1.1 GENERAL

1.1.1 Purpose. The *NEHRP Recommended Provisions for Seismic Regulations for New Buildings and Other Structures* (referred to hereinafter as the *Provisions*) present criteria for the design and construction of structures to resist earthquake ground motions. The purposes of these *Provisions* are as follows:

1. To provide minimum design criteria for structures appropriate to their primary function and use considering the need to protect the health, safety, and welfare of the general public by minimizing the earthquake-related risk to life and
2. To improve the capability of essential facilities and structures containing substantial quantities of hazardous materials to function during and after design earthquakes.

The design earthquake ground motion levels specified herein could result in both structural and nonstructural damage. For most structures designed and constructed according to these *Provisions*, structural damage from the design earthquake ground motion would be repairable although perhaps not economically so. For essential facilities, it is expected that the damage from the design earthquake ground motion would not be so severe as to preclude continued occupancy and function of the facility. The actual ability to accomplish these goals depends upon a number of factors including the structural framing type, configuration, materials, and as-built details of construction. For ground motions larger than the design levels, the intent of these *Provisions* is that there be a low likelihood of structural collapse.

1.1.2 Scope and application

1.1.2.1 Scope. These *Provisions* shall apply to the design and construction of structures—including additions, changes of use, and alterations—to resist the effects of earthquake motions. Every structure, and portion thereof, shall be designed and constructed to resist the effects of earthquake motions as prescribed by these *Provisions*.

Exceptions:

1. Detached one- and two-family dwellings in Seismic Design Category A, B, or C (as defined in Sec. 1.4) are exempt from all requirements of these *Provisions*.
2. Detached one- and two-family wood-frame dwellings that are designed and constructed in accordance with the conventional light-frame construction requirements in Sec. 12.5 are exempt from all other requirements of these *Provisions*.
3. Agricultural storage structures intended only for incidental human occupancy are exempt from all requirements of these *Provisions*.
4. Structures located within those regions of Figures 3.3-1 through 3.3-14 of these *Provisions* having S_S less than or equal to 0.15 and S_I less than or equal to 0.04 and structures assigned to Seismic Design Category A shall only be required to comply with Sec. 1.5 of these *Provisions*.

1.1.2.2 Additions. Additions shall be designed and constructed in accordance with the following:

1.1.2.2.1. An addition that is structurally independent from an existing structure shall be designed and constructed as required for a new structure in accordance with Sec. 1.1.2.1.

1.1.2.2.2. An addition that is not structurally independent from an existing structure shall be designed and constructed such that the entire structure complies with the seismic-force-resistance requirements for new structures unless all of the following conditions are satisfied:

1. The addition complies with the requirements for new structures, and
2. The addition does not increase the seismic forces in any structural element of the existing structure by more than 5 percent, unless the capacity of the element subject to the increased forces is still in compliance with these *Provisions*, and
3. The addition does not decrease the seismic resistance of any structural element of the existing structure to less than that required for a new structure.

1.1.2.3 Change of use. Where a change of use results in a structure being reclassified to a higher Seismic Use Group, the structure shall comply with the requirements of Section 1.1.2.1 for a new structure.

Exception: Where a change of use results in a structure being reclassified from Seismic Use Group I to Seismic Use Group II, compliance with these *Provisions* is not required if the structure is located where S_{DS} is less than 0.3.

1.1.2.4 Alterations. Alterations are permitted to be made to any structure without requiring the structure to comply with these *Provisions* provided the alterations comply with the requirements for a new structure. Alterations that increase the seismic force in any existing structural element by more than 5 percent or decrease the design strength of any existing structural element to resist seismic forces by more than 5 percent shall not be permitted unless the entire seismic-force-resisting system is determined to comply with these *Provisions* for a new structure. All alterations shall comply with these *Provisions* for a new structure.

Exception: Alterations to existing structural elements or additions of new structural elements that are not required by these *Provisions* and are initiated for the purpose of increasing the strength or stiffness of the seismic-force-resisting system of an existing structure need not be designed for forces in accordance with these *Provisions* provided that an engineering analysis is submitted indicating the following:

1. The design strengths of existing structural elements required to resist seismic forces is not reduced,
2. The seismic force to required existing structural elements is not increased beyond their design strength,
3. New structural elements are detailed and connected to the existing structural elements as required by these *Provisions*, and
4. New or relocated nonstructural elements are detailed and connected to existing or new structural elements as required by these *Provisions*.

1.1.2.5 Alternate materials and alternate means and methods of construction. Alternate materials and alternate means and methods of construction to those prescribed in these *Provisions* are permitted if approved by the authority having jurisdiction. Substantiating evidence shall be submitted demonstrating that the proposed alternate, for the purpose intended, will be at least equal in strength, durability, and seismic resistance.

1.1.3 References. The following reference document shall be used for loads other than earthquakes and for combinations of loads as indicated in this chapter:

ASCE 7 *Minimum Design Loads for Buildings and Other Structures*, American Society of Civil Engineers, 1998.

1.1.4 Definitions

Addition: An increase in the building area, aggregate floor area, height, or number of stories of a structure.

Alteration: Any construction or renovation to an existing structure other than an addition.

Component: A part or element of an architectural, electrical, mechanical, or structural system.

Dead load: See Sec. 4.1.3.

Design earthquake ground motion: The earthquake effects that structures are specifically proportioned to resist as defined in Chapter 3.

Essential facility: A facility or structure required for post-earthquake recovery.

Hazardous material: A material that is highly toxic or potentially explosive and in sufficient quantity to pose a significant life-safety threat to the general public if an uncontrolled release were to occur.

Live load: See Sec. 4.1.3.

Occupancy importance factor: A factor assigned to each structure according to its Seismic Use Group as prescribed in Sec. 1.3.

Owner: Any person, agent, firm, or corporation having a legal or equitable interest in the property.

Seismic Design Category: A classification assigned to a structure based on its Seismic Use Group and the severity of the design earthquake ground motion at the site.

Seismic-force-resisting system: That part of the structural system that has been considered in the design to provide the required resistance to the shear prescribed herein.

Seismic forces: The assumed forces prescribed herein, related to the response of the structure to earthquake motions, to be used in the design of the structure and its components.

Seismic Use Group: A classification assigned to the structure based on its use as defined in Sec. 1.2.

Structure: That which is built or constructed.

1.1.5 Notation

F_x The design lateral force applied at level x .

I The occupancy importance factor as defined in Sec. 1.3.

S_I See Sec. 3.1.4.

S_{DI} See Sec. 3.1.4.

S_{DS} See Sec. 3.1.4.

S_S See Sec. 3.1.4.

T See Sec. 4.1.4.

W The seismic weight, including the total dead load and applicable portions of other loads as required by these *Provisions*.

w_x The portion of the seismic weight, W , located or assigned to Level x .

Level x The level under consideration; $x = 1$ designates the first level above the base.

1.2 SEISMIC USE GROUPS

All structures shall be assigned to one of the following Seismic Use Groups:

1.2.1 Seismic Use Group III. Seismic Use Group III structures are those having essential facilities that are required for post-earthquake recovery and those containing substantial quantities of hazardous substances including:

1. Fire, rescue, and police stations
2. Hospitals
3. Designated medical facilities having emergency treatment facilities
4. Designated emergency preparedness centers
5. Designated emergency operation centers
6. Designated emergency shelters
7. Power generating stations or other utilities required as emergency back-up facilities for Seismic Use Group III facilities
8. Emergency vehicle garages and emergency aircraft hangars
9. Designated communication centers
10. Aviation control towers and air traffic control centers
11. Structures containing sufficient quantities of toxic or explosive substances deemed to be hazardous to the public
12. Water treatment facilities required to maintain water pressure for fire suppression.

1.2.2 Seismic Use Group II. Seismic Use Group II structures are those that have a substantial public hazard due to occupancy or use including:

1. Covered structures whose primary occupancy is public assembly with a capacity greater than 300 persons
2. Educational structures through the 12th grade with a capacity greater than 250 persons
3. Day care centers with a capacity greater than 150 persons
4. Medical facilities with greater than 50 resident incapacitated patients not otherwise designated a Seismic Use Group III structure
5. Jails and detention facilities
6. All structures with a capacity greater than 5,000 persons
7. Power generating stations and other public utility facilities not included in Seismic Use Group III and required for continued operation
8. Water treatment facilities required for primary treatment and disinfection for potable water
9. Waste water treatment facilities required for primary treatment.

1.2.3 Seismic Use Group I. Seismic Use Group I structures are those not assigned to Seismic Use Groups III or II.

1.2.4 Multiple use. Structures having multiple uses shall be assigned the classification of the use having the highest Seismic Use Group except that in structures having two or more portions which are structurally separated in accordance with Sec. 4.5.1, each portion shall be separately classified. Where a structurally separated portion of a structure provides access to, egress from, or shares life safety

components with another portion having a higher Seismic Use Group, the lower portion shall be assigned the same rating as the higher.

1.2.5 Seismic Use Group III structure access protection. Where operational access to a Seismic Use Group III structure is required through an adjacent structure, the adjacent structure shall comply with the requirements for Seismic Use Group III structures. Where operational access is less than 10 ft (3 m) from an interior lot line or less than 10 ft (3 m) from another structure, access protection from potential falling debris shall be provided by the owner of the Seismic Use Group III structure.

1.3 OCCUPANCY IMPORTANCE FACTOR

An occupancy importance factor, *I*, shall be assigned to each structure in accordance with Table 1.3-1.

Table 1.3-1 Occupancy Importance Factors

Seismic Use Group	<i>I</i>
I	1.0
II	1.25
III	1.5

1.4 SEISMIC DESIGN CATEGORY

Each structure shall be assigned to a Seismic Design Category in accordance with Sec. 1.4.1. Seismic Design Categories are used in these *Provisions* to determine permissible structural systems, limitations on height and irregularity, those components of the structure that must be designed for seismic resistance, and the types of lateral force analysis that must be performed.

1.4.1 Determination of Seismic Design Category. All structures shall be assigned to a Seismic Design Category based on their Seismic Use Group and the design spectral response acceleration parameters, S_{DS} and S_{DI} , determined in accordance with Chapter 3 of these *Provisions*. Each structure shall be assigned to the more severe Seismic Design Category determined in accordance with Tables 1.4-1 and 1.4-2, irrespective of the fundamental period of vibration of the structure, *T*. If the alternate design procedure of Alternative Simplified Chapter 4 is used, the Seismic Design Category shall be determined from Table 1.4-1 alone, and the value of S_{DS} shall be that determined in Sec Alt. 4.6.1.

Exception: The Seismic Design Category is permitted to be determined from Table 1.4-1 alone when all of the following apply:

1. In each of the two orthogonal directions, the approximate fundamental period of the structure, T_a , determined in accordance with Section 5.2.2.1, is less than $0.8T_s$, where T_s is determined in accordance with Section 3.3.4 and
2. In each of the two orthogonal directions, the fundamental period of the structure used to calculate the story drift is less than T_s and
3. Equation 5.2-2 is used to determine the seismic response coefficient, C_s and
4. The diaphragms are rigid or for diaphragms that are flexible, the distance between vertical elements of the seismic force-resisting system does not exceed 40 feet.

Table 1.4-1 Seismic Design Category Based on S_{DS}

Value of S_{DS}	Seismic Use Group		
	I	II	III
$S_{DS} < 0.167$	A	A	A
$0.167 \leq S_{DS} < 0.33$	B	B	C
$0.33 \leq S_{DS} < 0.50$	C	C	D
$0.50 \leq S_{DS}$	D ^a	D ^a	D ^a

^a See footnote to Table 1.4-2.

Table 1.4-2 Seismic Design Category Based on S_{DI}

Value of S_{DI}	Seismic Use Group		
	I	II	III
$S_{DI} < 0.067$	A	A	A
$0.067 \leq S_{DI} < 0.133$	B	B	C
$0.133 \leq S_{DI} < 0.20$	C	C	D
$0.20 \leq S_{DI}$	D ^a	D ^a	D ^a

^a Seismic Use Group I and II structures located on sites with S_I greater than or equal to 0.75 shall be assigned to Seismic Design Category E and Seismic Use Group III structures located on such sites shall be assigned to Seismic Design Category F.

1.4.2 Site limitation for Seismic Design Categories E and F. A structure assigned to Seismic Design Category E or F shall not be sited where there is the potential for an active fault to cause rupture of the ground surface at the structure.

Exception: Detached one- and two-family dwellings of light-frame construction.

1.5 REQUIREMENTS FOR SEISMIC DESIGN CATEGORY A

Structures assigned to Seismic Design Category A shall satisfy the requirements of this section.

The effects on the structure and its components due to the forces prescribed in this section shall be taken as E and combined with the effects of other loads in accordance with the load combinations of ASCE 7.

1.5.1 Lateral forces. Each structure shall be analyzed for the effects of static lateral forces applied independently in each of two orthogonal directions. In each direction, the static lateral forces at all levels shall be applied simultaneously. The force at each level shall be determined using Eq. 1.5-1 as follows:

$$F_x = 0.01w_x \quad (1.5-1)$$

where:

F_x = the design lateral force applied at Level x ,

w_x = the portion of the seismic weight, W , located or assigned to Level x , and

W = the seismic weight, including the total dead load and applicable portions of other loads listed below:

1. In areas used for storage, a minimum of 25 percent of the floor live load shall be applicable. Floor live load in public garages and open parking structures is not applicable.
2. Where an allowance for partition load is included in the floor load design, the actual partition weight or a minimum weight of 10 psf (500 Pa/m²) of floor area, whichever is greater, shall be applicable.
3. Total operating weight of permanent equipment.
4. In areas where the design flat roof snow load does not exceed 30 pounds per square foot, the effective snow load is permitted to be taken as zero. In areas where the design snow load is greater than 30 pounds per square foot and where siting and load duration conditions warrant and where approved by the authority having jurisdiction, the effective snow load is permitted to be reduced to not less than 20 percent of the design snow load.

1.5.2 Connections. All parts of the structure between separation joints shall be interconnected, and the connections shall be capable of transmitting the seismic forces induced by the parts being connected. Any smaller portion of the structure shall be tied to the remainder of the structure with elements having a strength of not less than 5 percent of the portion's weight.

A positive connection for resisting a horizontal force acting parallel to the member shall be provided for each beam, girder, or truss to its support. The connection shall have a minimum strength of 5 percent of the reaction due to dead load and live load.

1.5.3 Anchorage of concrete or masonry walls. Concrete or masonry walls shall be connected, using reinforcement or anchors, to the roof and all floors and members that provide lateral support for the wall or that are supported by the wall. The connection shall be capable of resisting a seismic lateral force induced by the wall of 100 pounds per lineal foot (1500 N/m). Walls shall be designed to resist bending between connections where the spacing exceeds 4 ft (1.2 m).

1.5.4 Tanks assigned to Seismic Use Group III. Tanks assigned to Seismic Use Group III, according to Table 14.2-2, shall comply with the freeboard requirements of Sec. 14.4.7.5.3. For tanks in Seismic Design Category A it shall be permitted to take S_{DS} equal to 0.166 and S_{DI} equal to 0.066 without determining the site class.

This page intentionally left blank.

Chapter 2

QUALITY ASSURANCE

2.1 GENERAL

2.1.1 Scope. This chapter provides minimum requirements for quality assurance for seismic-force-resisting systems and designated seismic systems. These requirements supplement the testing and inspection requirements contained in the reference standards given elsewhere in these *Provisions*.

2.1.2 References. The following documents shall be used as specified in this chapter.

- ACI 318 *Building Code Requirements for Structural Concrete*, American Concrete Institute, 1999.
- ACI 530 *Building Code Requirements for Masonry Structures* (ACI 530-99/ASCE 5-99/TMS 402-99), American Concrete Institute/American Society of Civil Engineers/The Masonry Society, 1999.
- ACI 530.1 *Specifications for Masonry Structures* (ACI 530.1-99/ASCE 6-99/TMS 602-99), American Concrete Institute/American Society of Civil Engineers/The Masonry Society, 1999.
- AISC LRFD *Load and Resistance Factor Design Specification for Structural Steel Buildings*, American Institute of Steel Construction, 1993.
- AISC Seismic *Seismic Provisions for Structural Steel Buildings*, Part I, American Institute of Steel Construction, 1997, including Supplement No. 2 (2000).
- ASTM A 435 *Standard Specification for Straight Beam Ultrasound Examination of Steel Plates* (A 435-90), American Society for Testing and Materials, 1996.
- ASTM A 615 *Standard Specification for Deformed and Plain Billet-steel Bars for Concrete Reinforcement* (A 615/A 615M-96a), American Society for Testing and Materials, 1996.
- ASTM A 898 *Standard Specification for Straight Beam Ultrasound Examination for Rolled Steel Structural Shapes* (A 898/A 898M-91), American Society for Testing and Materials, 1996.

2.1.3 Definitions

Approval: The written acceptance by the authority having jurisdiction of documentation that establishes the qualification of a material, system, component, procedure, or person to fulfill the requirements of these *Provisions* for the intended use.

Boundary elements:

In wood construction, members at the boundaries of diaphragms and shear walls to which sheathing transfers forces. Such elements include chords and drag struts at diaphragm and shear wall perimeters, interior openings, discontinuities, and re-entrant corners.

In concrete and masonry construction, portions along wall and diaphragm edges strengthened by longitudinal and transverse reinforcement and/or structural steel members.

Component: See Sec. 1.1.4.

Construction documents: The written, graphic, electronic, and pictorial documents describing the design, locations, and physical characteristics of the project required to verify compliance with these *Provisions*.

Continuous special inspection: A full-time observation of the work by an approved special inspector who is present in the area where work is being performed.

Designated seismic system: Those architectural, mechanical, and electrical systems and their components that require design in accordance with Sec. 6.1 and that have a component importance factor, I_p , greater than 1.

Design strength: See Sec. 4.1.3.

Diaphragm: See Sec. 4.1.3.

Drag strut: See Sec. 4.1.3.

Glazed curtain wall: See Sec. 6.1.3.

Glazed storefront: See Sec. 6.1.3.

Intermediate moment frame: See Sec. 4.1.3.

Isolation system: See Sec. 13.1.2.

Isolator unit: See Sec. 13.1.2.

Moment frame: See Sec. 4.1.3.

Partition: See Sec. 5.1.2.

Periodic special inspection: The part-time or intermittent observation of the work by an approved special inspector who is present in the area where work has been or is being performed.

Quality Assurance: The systematic program of special inspections, structural observations, testing and reporting which provides the independent documentation that the project is constructed in accordance with the construction documents.

Quality Assurance Plan: A detailed, written procedural document, prepared by one or more registered design professionals, that establishes the systems and components subject to special inspection and testing.

Quality Control: The operational procedures provided by contractors to ensure compliance with the construction documents and regulatory requirements.

Registered design professional: An architect or engineer, registered or licensed to practice professional architecture or engineering, as defined by statutory requirements of the professional registrations laws of the state in which the project is to be constructed.

Seismic Design Category: See Sec. 1.1.4.

Seismic-force-resisting system: See Sec. 1.1.4.

Seismic Use Group: See Sec. 1.1.4.

Shear panel: See Sec. 4.1.3.

Shear wall: See Sec. 4.1.3.

Special inspection: The observation of the work by the special inspector to determine compliance with the approved construction documents and these *Provisions*.

Special inspector: A person or persons approved by the authority having jurisdiction as being qualified to perform special inspection required by the approved quality assurance plan. The quality assurance personnel of a fabricator are permitted to be approved by the authority having jurisdiction as a special inspector.

Special moment frame: See Sec. 4.1.3.

Story: See Sec. 4.1.3.

Structural observations: The visual observations performed by the registered design professional in responsible charge (or another registered design professional) to determine that the seismic-force-resisting system is constructed in general conformance with the construction documents.

Structure: See Sec. 1.1.4.

Testing agency: A company or corporation that provides testing and/or inspection services. The person in responsible charge of the special inspector and the testing services shall be a registered design professional.

Tie-down: See Sec. 12.1.3.

Veneer: Facing or ornamentation of brick, concrete, stone, tile, or similar materials attached to a backing.

2.1.4 Notation

S_{DS} See Sec. 3.1.4.

2.2 GENERAL REQUIREMENTS

As required in this section, a quality assurance plan shall be submitted to the authority having jurisdiction. A quality assurance plan, special inspection, and testing as set forth in this chapter shall be provided for the following:

1. The seismic-force-resisting systems in structures assigned to Seismic Design Category C, D, E, or F.
2. Designated seismic systems in structures assigned to Seismic Design Category D, E, or F.

Exception: Structures that comply with item a and item b and with either item c or item d of the following criteria are exempt from the preparation of a quality assurance plan but are not exempt from special inspection or testing requirements:

- a. The structure is assigned to Seismic Use Group I.
- b. The structure does not have any of the following irregularities as defined in Tables 4.3-2 and 4.3-3:
 - i. Torsional irregularity,
 - ii. Extreme torsional irregularity,
 - iii. Nonparallel systems,
 - iv. Stiffness irregularity—soft story,
 - v. Stiffness irregularity—extreme soft story,
 - vi. Discontinuity in capacity—weak story.
- c. The structure is constructed of light wood framing or light gauge cold-formed steel framing, S_{DS} does not exceed 0.5, and the height of the structure does not exceed 35 ft above grade.
- d. The structure is constructed using a reinforced masonry structural system or reinforced concrete structural system, S_{DS} does not exceed 0.5, and the height of the structure does not exceed 25 ft above grade.

2.2.1 Details of quality assurance plan. The registered design professional in responsible charge of the design of a seismic-force-resisting system or a designated seismic system shall be responsible for the portion of the quality assurance plan applicable to that system. The quality assurance plan shall include:

1. A listing of the seismic-force-resisting systems and designated seismic systems that are subject to quality assurance in accordance with this chapter.
2. The required special inspection and testing.
3. The type and frequency of testing.

4. The type and frequency of special inspection.
5. The frequency and distribution of testing and special inspection reports.
6. The structural observations to be performed.
7. The frequency and distribution of structural observation reports.

2.2.2 Contractor responsibility. Each contractor responsible for the construction of a seismic-force-resisting system, designated seismic system, or component listed in the quality assurance plan shall submit a written contractor's statement of responsibility to the authority having jurisdiction and to the owner prior to the commencement of work on the system or component. The contractor's statement of responsibility shall contain the following:

1. Acknowledgment of awareness of the requirements contained in the quality assurance plan;
2. Acknowledgment that control will be exercised to obtain conformance with the construction documents approved by the authority having jurisdiction;
3. Procedures for exercising control within the contractor's organization, the method and frequency of reporting, and the distribution of the reports; and
4. Identification and qualifications of the person(s) exercising such control and their position(s) in the organization.

2.3 SPECIAL INSPECTION

The owner shall employ a special inspector who, at a minimum, shall perform the following inspections:

2.3.1 Piers, piles, and caissons. Continuous special inspection during driving of piles and placement of concrete in piers, piles, and caissons. Periodic special inspection during construction of drilled piles, piers, and caissons including the placement of reinforcing steel.

2.3.2 Reinforcing steel

2.3.2.1. Periodic special inspection during and upon completion of the placement of reinforcing steel in intermediate moment frames, in special moment frames, and in shear walls.

2.3.2.2. Continuous special inspection during the welding of reinforcing steel resisting flexural and axial forces in intermediate moment frames and special moment frames, in boundary elements of concrete shear walls, and during welding of shear reinforcement.

2.3.3 Structural concrete. Periodic special inspection during and on completion of the placement of concrete in intermediate moment frames, in special moment frames, and in boundary elements of shear walls.

2.3.4 Prestressed concrete. Periodic special inspection during the placement and after completion of placement of prestressing steel and continuous special inspection during all stressing and grouting operations and during the placement of concrete.

2.3.5 Structural masonry

2.3.5.1. Periodic special inspection during the preparation of mortar, the laying of masonry units, and placement of reinforcement, and prior to placement of grout.

2.3.5.2. Continuous special inspection during the welding of reinforcement, grouting, consolidation, reconsolidation, and placement of bent-bar anchors as required by Sec. 11.6.4.1.

2.3.6 Structural steel

2.3.6.1. Continuous special inspection for all structural welding.

Exception: Periodic special inspection is permitted for single-pass fillet or resistance welds and welds loaded to less than 50 percent of their design strength provided the qualifications of the

welder and the welding electrodes are inspected at the beginning of the work and all welds are inspected for compliance with the approved construction documents at the completion of welding.

2.3.6.2. Periodic special inspection in accordance with AISC LRFD for installation and tightening of fully tensioned high-strength bolts in slip-critical connections and in connections subject to direct tension. Bolts in connections identified as not being slip-critical or subject to direct tension need not be inspected for bolt tension other than to ensure that the plies of the connected elements have been brought into snug contact.

2.3.7 Structural wood

2.3.7.1. Continuous special inspection during all field gluing operations of elements of the seismic-force-resisting system.

2.3.7.2. Periodic special inspection for nailing, bolting, anchoring, and other fastening of components within the seismic-force-resisting system including drag struts, braces, and tie-downs.

2.3.7.3. Periodic special inspection for wood shear walls, shear panels, and diaphragms that are included in the seismic-force-resisting system and for which the *Provisions* require the spacing of nails, screws, or fasteners for wood sheathing to be 4 in. or less on center.

2.3.8 Cold-formed steel framing

2.3.8.1. Periodic special inspections during all welding operations of elements of the seismic-force-resisting system.

2.3.8.2. Periodic special inspections for screw attachment, bolting, anchoring, and other fastening of components within the seismic-force-resisting system, including struts, braces, and tie-downs.

2.3.9 Architectural components. Special inspection for architectural components shall be as follows:

1. Periodic special inspection during the erection and fastening of exterior cladding, interior and exterior nonbearing walls, and interior and exterior veneer in Seismic Design Category D, E, or F.

Exceptions:

- a. Architectural components less than 30 ft (9 m) above grade or walking surface
 - b. Cladding and veneer weighing 5 lb/ft² (24.5 N/m²) or less
 - c. Interior nonbearing walls weighing 15 lb/ft² (73.5 N/m²) or less.
2. Periodic special inspection during erection of glass 30 ft (9 m) or more above an adjacent grade or walking surface in glazed curtain walls, glazed storefronts, and interior glazed partitions in Seismic Design Category D, E, or F.
 3. Periodic special inspection during the anchorage of access floors, suspended ceiling grids, and storage racks 8 ft (2.4 m) or more in height in Seismic Design Category D, E, or F.

2.3.10 Mechanical and electrical components. Special inspection for mechanical and electrical components shall be as follows:

1. Periodic special inspection during the anchorage of electrical equipment for emergency or standby power systems in Seismic Design Category C, D, E, or F;
2. Periodic special inspection during the installation of anchorage of all other electrical equipment in Seismic Design Category E or F;
3. Periodic special inspection during installation for flammable, combustible, or highly toxic piping systems and their associated mechanical units in Seismic Design Category C, D, E, or F;

4. Periodic special inspection during the installation of HVAC ductwork that will contain hazardous materials in Seismic Design Category C, D, E, or F; and
5. Periodic special inspection during the installation of vibration isolation systems where the construction documents call for a nominal clearance (air gap) between the equipment support frame and restraint less than or equal to 0.25 inches.

2.3.11 Seismic isolation system. Periodic special inspection during the fabrication and installation of isolator units and energy dissipation devices if used as part of the seismic isolation system.

2.4 TESTING

The special inspector shall be responsible for verifying that the testing requirements are performed by an approved testing agency for compliance with the following:

2.4.1 Reinforcing and prestressing steel. Special testing of reinforcing and prestressing steel shall be as follows:

2.4.1.1. Examine certified mill test reports for each shipment of reinforcing steel used to resist flexural and axial forces in reinforced concrete intermediate frames, special moment frames, and boundary elements of reinforced concrete shear walls or reinforced masonry shear walls and determine conformance with the construction documents.

2.4.1.2. Where ASTM A 615 reinforcing steel is used to resist earthquake-induced flexural and axial forces in special moment frames and in wall boundary elements of shear walls in structures assigned to Seismic Design Category D, E, or F, verify that the requirements of Sec. 21.2.5 of ACI 318 have been satisfied.

2.4.1.3. Where ASTM A 615 reinforcing steel is to be welded, verify that chemical tests have been performed to determine weldability in accordance with Sec. 3.5.2 of ACI 318.

2.4.2 Structural concrete. Samples of structural concrete shall be obtained at the project site and tested in accordance with requirements of ACI 318.

2.4.3 Structural masonry. Quality assurance testing of structural masonry shall be in accordance with the requirements of ACI 530 and ACI 530.1.

2.4.4 Structural steel. The testing needed to establish that the construction is in conformance with these *Provisions* shall be included in a quality assurance plan. The minimum testing contained in the quality assurance plan shall be as required in AISC Seismic and the following requirements:

2.4.4.1 Base metal testing. Base metal thicker than 1.5 in. (38 mm), where subject to through-thickness weld shrinkage strains, shall be ultrasonically tested for discontinuities behind and adjacent to such welds after joint completion. Any material discontinuities shall be accepted or rejected on the basis of ASTM A 435 or ASTM A 898 (Level 1 Criteria) and criteria as established by the registered design professional in responsible charge and the construction documents.

2.4.5 Mechanical and electrical equipment. As required to ensure compliance with the seismic design requirements herein, the registered design professional in responsible charge shall clearly state the applicable requirements on the construction documents. Each manufacturer of designated seismic system components shall test or analyze the component and its mounting system or anchorage as required and shall submit evidence of compliance for review and acceptance by the registered design professional in responsible charge of the designated seismic system and for approval by the authority having jurisdiction. The evidence of compliance shall be by actual test on a shake table, by three-dimensional shock tests, by an analytical method using dynamic characteristics and forces, by the use of experience data (i.e., historical data demonstrating acceptable seismic performance), or by more rigorous analysis providing for equivalent safety. The special inspector shall examine the designated seismic system and shall determine whether the anchorages and label conform with the evidence of compliance.

2.4.6 Seismically isolated structures. Isolation system components shall be tested in accordance with Sec 13.6.

2.5 STRUCTURAL OBSERVATIONS

Structural observations shall be provided for those structures assigned to Seismic Design Category D, E, or F where one or more of the following conditions exist:

1. The structure is included in Seismic Use Group II or Seismic Use Group III or
2. The height of the structure is greater than 75 ft above the base or
3. The structure is in Seismic Design Category E or F and Seismic Use Group I and is greater than two stories in height.

Observed deficiencies shall be reported in writing to the owner and the authority having jurisdiction.

2.6 REPORTING AND COMPLIANCE PROCEDURES

Each special inspector shall furnish copies of inspection reports, noting any work not in compliance with the approved construction documents and corrections made to previously reported work to the authority having jurisdiction, registered design professional in responsible charge, the owner, the registered design professional preparing the quality assurance plan, and the contractor. All deficiencies shall be brought to the immediate attention of the contractor for correction.

At completion of construction, each special inspector shall submit a report certifying that all inspected work was completed substantially in compliance with the approved construction documents. Work not in compliance with the approved construction documents shall be described in the report.

At completion of construction, the contractor shall submit a final report to the authority having jurisdiction certifying that all construction work incorporated into the seismic-force-resisting system and other designated seismic systems was constructed substantially in compliance with the approved construction documents.

This page is intentionally left blank.

Chapter 3

GROUND MOTION

3.1 GENERAL

3.1.1 Scope. All structures shall be designed for the earthquake ground motions prescribed in this chapter. If the alternate design procedure of Alternative Simplified Chapter 4 is used, the values of F_a , S_{MS} , and S_{DS} shall be as determined in that Alternate Chapter, and values for F_v , S_{MI} , and S_{DI} need not be determined.

3.1.2 References. The following documents shall be used as specified in this chapter.

ASTM D 1586 *Standard Test Method for Penetration Test and Split-barrel Sampling of Soils* (D 1586-99), American Society for Testing and Materials, 2003.

ASTM D 2166 *Standard Test Method for Unconfined Compressive Strength of Cohesive Soil* (D 2166-00), American Society for Testing and Materials, 2003.

ASTM D 2216 *Standard Test Method for Laboratory Determination of Water (Moisture) Content of Soil and Rock by Mass* (D 2216-98), American Society for Testing and Materials, 2003.

ASTM D 2850 *Standard Test Method for Unconsolidated-Undrained Triaxial Compression Test on Cohesive Soils in* (D 2850-03), American Society for Testing and Materials, 2003.

ASTM D 4318 *Standard Test Methods for Liquid Limit, Plastic Limit, and Plasticity Index of Soils* (D 4318-00), American Society for Testing and Materials, 2003.

3.1.3 Definitions

Active fault: A fault for which there is an average historic slip rate of 1 mm per year or more and geographic evidence of seismic activity within Holocene times (past 11,000 years).

Characteristic earthquake: An earthquake assessed for an active fault having a magnitude equal to the best-estimate of the maximum magnitude capable of occurring on the fault, but not less than the largest magnitude that has occurred historically on the fault.

Design earthquake ground motion: See Sec. 1.1.4.

Maximum considered earthquake ground motion: The most severe earthquake effects considered by these *Provisions* as defined in this chapter.

Seismic Design Category: See Sec. 1.1.4.

Site Class: A classification assigned to a site based on the types of soils present and their properties as defined in Sec. 3.5.1.

Site coefficients: The values of F_a and F_v indicated in Tables 3.3-1 and 3.3-2, respectively.

Structure: See Sec. 1.1.4.

3.1.4 Notation

d_c The total thickness of cohesive soil layers in the top 100 ft (30 m); see Sec. 3.5.1.

d_i The thickness of any soil or rock layer i (between 0 and 100 ft [30 m]); see Sec. 3.5.1.

d_s The total thickness of cohesionless soil layers in the top 100 ft (30 m); see Sec. 3.5.1.

F_a Short-period site coefficient (at 0.2 sec period); see Sec. 3.3.2.

F_v	Long-period site coefficient (at 1.0 second period); see Sec. 3.3.2.
H	Thickness of soil.
N	Standard penetration resistance, ASTM D1586-99.
N_i	Standard penetration resistance of any soil or rock layer i (between 0 and 100 ft (30m)); see Sec.3.5.1.
\bar{N}	Average standard penetration resistance for the top 100 ft (30 m); see Sec. 3.5.1.
\bar{N}_{ch}	Average standard penetration resistance of cohesionless soil layers for the top 100 ft (30 m); see Sec. 3.5.1.
PI	Plasticity index, ASTM D4318.
S_I	The mapped, maximum considered earthquake, 5-percent-damped, spectral response acceleration parameter at a period of one second as determined in Sec. 3.3.1.
S_a	The design spectral response acceleration at any period as defined in this chapter.
S_{aM}	The maximum considered earthquake spectral response acceleration at any period as defined in this chapter.
S_{DI}	The design, 5-percent-damped, spectral response acceleration parameter at a period of one second as defined in Sec. 3.3.3.
S_{DS}	The design, 5-percent-damped, spectral response acceleration parameter at short periods as defined in Sec. 3.3.3.
S_{MI}	The maximum considered earthquake, 5-percent-damped, spectral response acceleration parameter at a period of one second adjusted for site class effects as defined in Sec. 3.3.2.
S_{MS}	The maximum considered earthquake, 5-percent-damped, spectral response acceleration parameter at short periods adjusted for site class effects as defined in Sec. 3.3.2.
S_S	The mapped, maximum considered earthquake, 5-percent-damped, spectral response acceleration parameter at short periods as determined in Sec. 3.3.1.
s_u	Undrained shear strength, ASTM D2166 or ASTM D2850.
s_{ui}	Undrained shear strength of any cohesive soil layer i (between 0 and 100 ft (30 m)); see Sec. 3.5.1.
\bar{s}_u	Average undrained shear strength in top 100 ft. (30 m); see Sec. 3.5.1.
T	See Sec. 4.1.4.
T_0	$0.2S_{DI}/S_{DS}$
T_L	Long-period transition period as defined in Sec. 3.3.4.
T_S	S_{DI}/S_{DS} .
v_s	The shear wave velocity at small shear strains (equal to 10-3 percent strain or less).
v_{si}	The shear wave velocity of any soil or rock layer i (between 0 and 100 ft (30m)); see Sec. 3.5.1.
\bar{v}_s	The average shear wave velocity at small shear strains in the top 100 ft (30 m); see Sec. 3.5.1.
w	Moisture content (in percent), ASTM D2216.

3.2 GENERAL REQUIREMENTS

As used in these *Provisions*, spectral acceleration parameters are coefficients corresponding to spectral accelerations in terms of g , the acceleration due to gravity.

3.2.1 Site Class. For all structures, the site shall be classified in accordance with Sec. 3.5.

3.2.2 Procedure selection

Ground motions, represented by response spectra and parameters associated with those spectra, shall be determined in accordance with the general procedure of Sec. 3.3 or the site-specific procedure of Sec. 3.4. Ground motions for structures on class F sites and for seismically isolated structures on sites with S_I greater than 0.6 shall be determined using the site-specific procedure of Sec. 3.4.

3.3 GENERAL PROCEDURE

3.3.1 Mapped acceleration parameters. The parameters S_S and S_I shall be determined from the respective 0.2 sec and 1.0 sec spectral response accelerations shown on Figures 3.3-1 through Figures 3.3-14.

3.3.2 Site coefficients and adjusted acceleration parameters. The maximum considered earthquake (MCE) spectral response acceleration parameters S_{MS} and S_{MI} , adjusted for site class effects, shall be determined using Eq. 3.3-1 and 3.3-2, respectively:

$$S_{MS} = F_a S_S \quad (3.3-1)$$

and

$$S_{MI} = F_v S_I \quad (3.3-2)$$

where F_a and F_v are defined in Tables 3.3-1 and 3.3-2, respectively.

Table 3.3-1 Values of Site Coefficient F_a

Site Class	Mapped MCE Spectral Response Acceleration Parameter at 0.2 Second Period ^a				
	$S_S \leq 0.25$	$S_S = 0.50$	$S_S = 0.75$	$S_S = 1.00$	$S_S \geq 1.25$
A	0.8	0.8	0.8	0.8	0.8
B	1.0	1.0	1.0	1.0	1.0
C	1.2	1.2	1.1	1.0	1.0
D	1.6	1.4	1.2	1.1	1.0
E	2.5	1.7	1.2	0.9	0.9
F	— ^b	— ^b	— ^b	— ^b	— ^b

^a Use straight line interpolation for intermediate values of S_S .

^b Site-specific geotechnical investigation and dynamic site response analyses shall be performed.

FIGURE 3.3-1 MAXIMUM CONSIDERED EARTHQUAKE GROUND MOTION FOR THE CONTERMINOUS UNITED STATES OF 0.2 SEC SPECTRAL RESPONSE ACCELERATION (5% OF CRITICAL DAMPING), SITE CLASS B

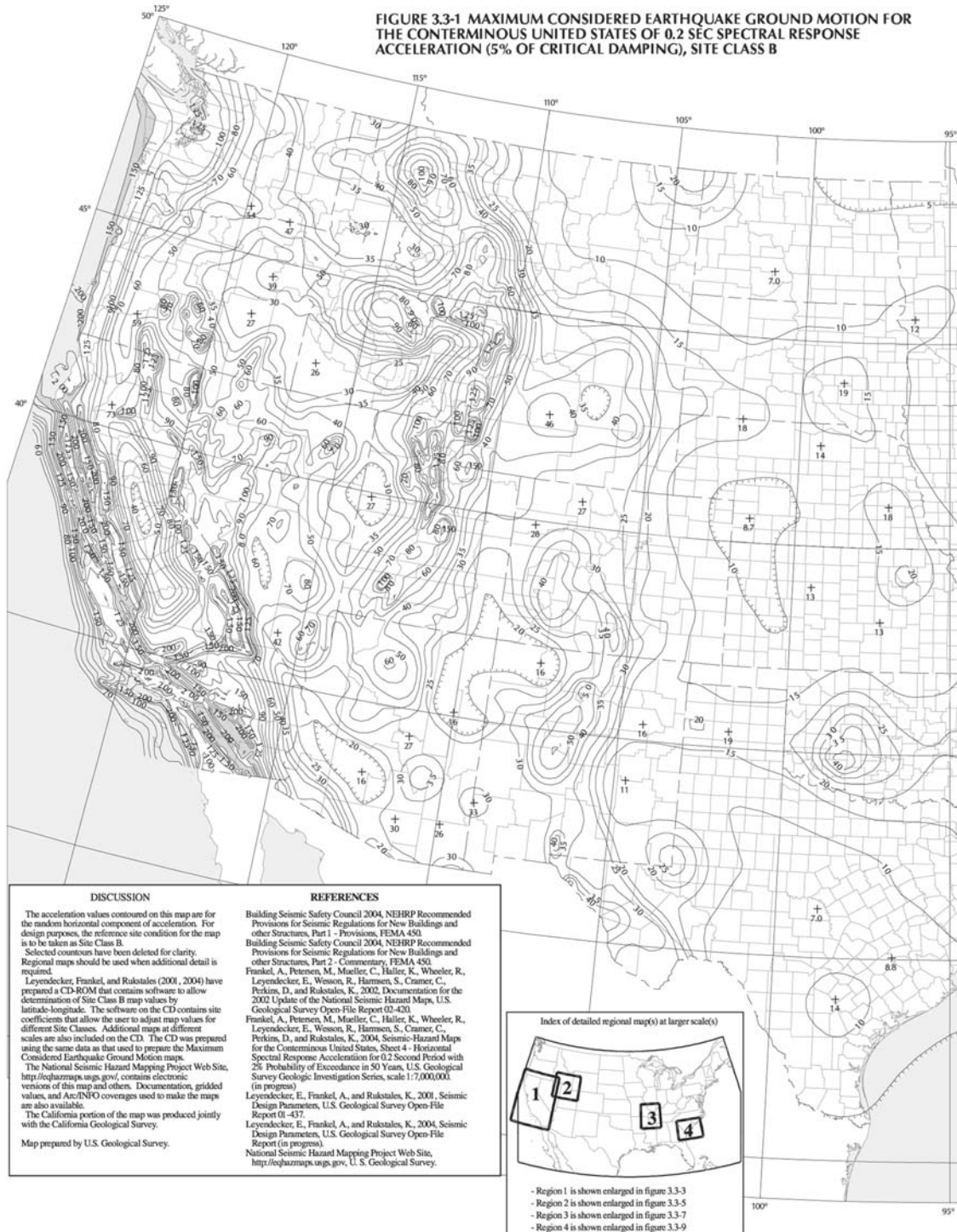

DISCUSSION

The acceleration values contoured on this map are for the random horizontal component of acceleration. For design purposes, the reference site condition for the map is to be taken as Site Class B.
 Selected contours have been deleted for clarity. Regional maps should be used when additional detail is required.
 Leyendecker, Frankel, and Rukstales (2004, 2004) have prepared a CD-ROM that contains software to allow determination of Site Class B map values by latitude-longitude. The software on the CD contains site coefficients that allow the user to adjust map values for different Site Classes. Additional maps at different scales are also included on the CD. The CD was prepared using the same data as that used to prepare the Maximum Considered Earthquake Ground Motion maps.
 The National Seismic Hazard Mapping Project Web Site, <http://eqhazmaps.usgs.gov>, contains electronic versions of this map and others. Documentation, gridded values, and Arc/INFO coverages used to make the maps are also available.
 The California portion of the map was produced jointly with the California Geological Survey.
 Map prepared by U.S. Geological Survey.

REFERENCES

Building Seismic Safety Council 2004, NEHRP Recommended Provisions for Seismic Regulations for New Buildings and other Structures, Part 1 - Provisions, FEMA 450.
 Building Seismic Safety Council 2004, NEHRP Recommended Provisions for Seismic Regulations for New Buildings and other Structures, Part 2 - Commentary, FEMA 450.
 Frankel, A., Petersen, M., Mueller, C., Haller, K., Wheeler, R., Leyendecker, E., Wesson, R., Harmsen, S., Cramer, C., Perkins, D., and Rukstales, K., 2002. Documentation for the 2002 Update of the National Seismic Hazard Maps, U.S. Geological Survey Open-File Report 02-420.
 Frankel, A., Petersen, M., Mueller, C., Haller, K., Wheeler, R., Leyendecker, E., Wesson, R., Harmsen, S., Cramer, C., Perkins, D., and Rukstales, K., 2004. Seismic-Hazard Maps for the Conterminous United States, Sheet 4 - Horizontal Spectral Response Acceleration for 0.2 Second Period with 2% Probability of Exceedance in 50 Years, U.S. Geological Survey Geologic Investigation Series, scale 1:7,000,000. (in progress)
 Leyendecker, E., Frankel, A., and Rukstales, K., 2001. Seismic Design Parameters, U.S. Geological Survey Open-File Report 01-437.
 Leyendecker, E., Frankel, A., and Rukstales, K., 2004. Seismic Design Parameters, U.S. Geological Survey Open-File Report (in progress).
 National Seismic Hazard Mapping Project Web Site, <http://eqhazmaps.usgs.gov>, U. S. Geological Survey.

Index of detailed regional map(s) at larger scale(s)

- Region 1 is shown enlarged in figure 3.3-3
- Region 2 is shown enlarged in figure 3.3-5
- Region 3 is shown enlarged in figure 3.3-7
- Region 4 is shown enlarged in figure 3.3-9

FIGURE 3.3-1 (continued) MAXIMUM CONSIDERED EARTHQUAKE GROUND MOTION FOR THE CONTERMINOUS UNITED STATES OF 0.2 SEC SPECTRAL RESPONSE ACCELERATION (5% OF CRITICAL DAMPING), SITE CLASS B



FIGURE 3.3-2 MAXIMUM CONSIDERED EARTHQUAKE GROUND MOTION FOR THE CONTERMINOUS UNITED STATES OF 1.0 SEC SPECTRAL RESPONSE ACCELERATION (5% OF CRITICAL DAMPING), SITE CLASS B

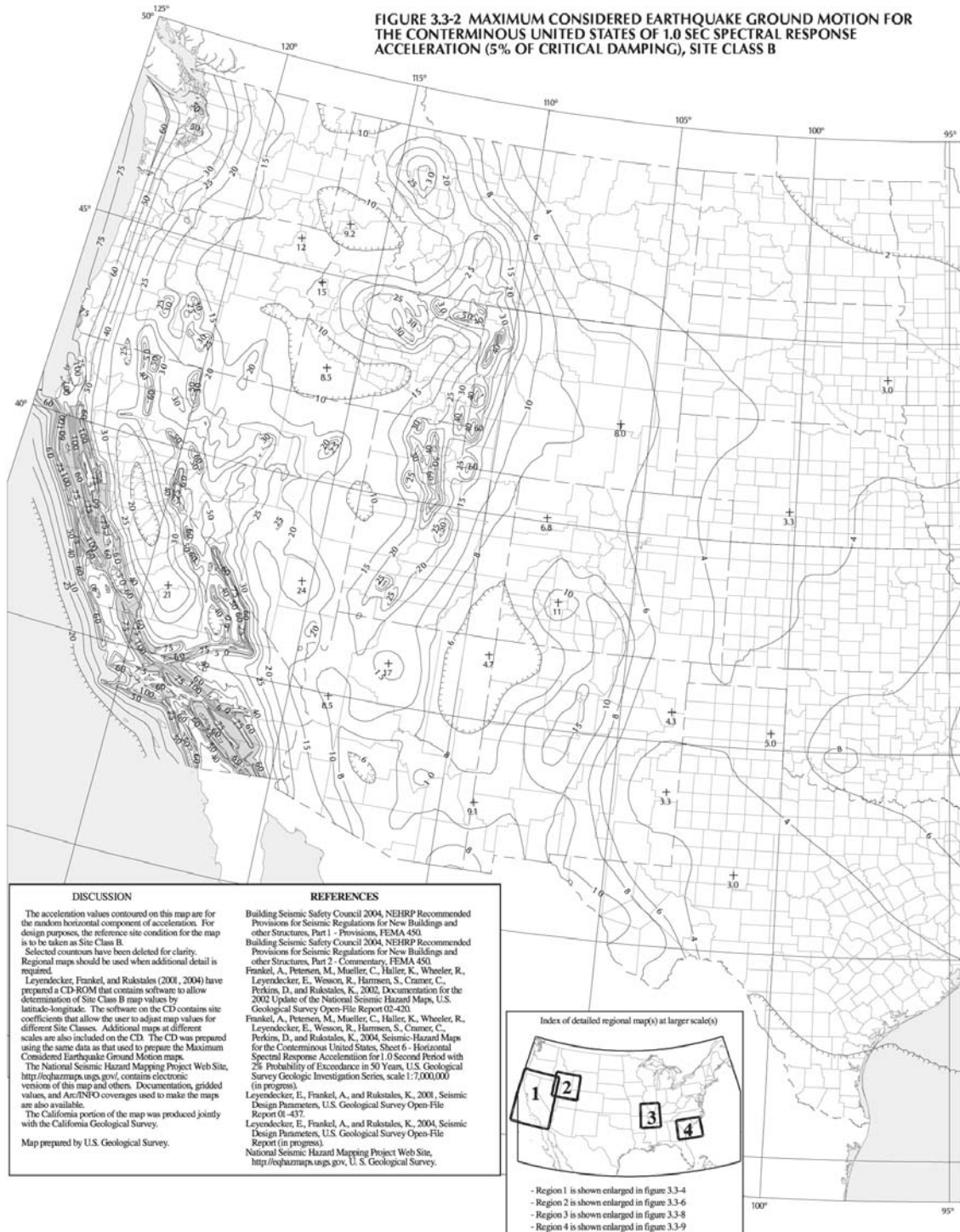

DISCUSSION

The acceleration values contoured on this map are for the random horizontal component of acceleration. For design purposes, the reference site condition for the map is to be taken as Site Class B.

Selected contours have been deleted for clarity. Regional maps should be used when additional detail is required.

Leyendecker, Frankel, and Rukstales (2008, 2004) have prepared a CD-ROM that contains software to allow determination of Site Class B map values by latitude-longitude. The software on the CD contains site coefficients that allow the user to adjust map values for different Site Classes. Additional maps at different scales are also included on the CD. The CD was prepared using the same data as that used to prepare the Maximum Considered Earthquake Ground Motion maps.

The National Seismic Hazard Mapping Project Web Site, <http://eqhazmaps.usgs.gov>, contains electronic versions of this map and others. Documentations, gridded values, and Arc/INFO coverages used to make the maps are also available.

The California portion of the map was produced jointly with the California Geological Survey.

Map prepared by U.S. Geological Survey.

REFERENCES

Building Seismic Safety Council 2004, NEHRP Recommended Provisions for Seismic Regulations for New Buildings and other Structures, Part 1 - Provisions, FEMA 450.

Building Seismic Safety Council 2004, NEHRP Recommended Provisions for Seismic Regulations for New Buildings and other Structures, Part 2 - Commentary, FEMA 450.

Frankel, A., Petersen, M., Mueller, C., Haller, K., Wheeler, R., Leyendecker, E., Wesson, R., Harmsen, S., Cramer, C., Perkins, D., and Rukstales, K., 2002, Documentation for the 2002 Update of the National Seismic Hazard Maps, U.S. Geological Survey Open-File Report 02-420.

Frankel, A., Petersen, M., Mueller, C., Haller, K., Wheeler, R., Leyendecker, E., Wesson, R., Harmsen, S., Cramer, C., Perkins, D., and Rukstales, K., 2004, Seismic Hazard Maps for the Conterminous United States, Sheet 6 - Horizontal Spectral Response Acceleration for 1.0 Second Period with 2% Probability of Exceedence in 50 Years, U.S. Geological Survey Geologic Investigation Series, scale 1:7,000,000 (in progress).

Leyendecker, E., Frankel, A., and Rukstales, K., 2001, Seismic Design Parameters, U.S. Geological Survey Open-File Report 01-437.

Leyendecker, E., Frankel, A., and Rukstales, K., 2004, Seismic Design Parameters, U.S. Geological Survey Open-File Report (in progress).

National Seismic Hazard Mapping Project Web Site, <http://eqhazmaps.usgs.gov>, U. S. Geological Survey.

Index of detailed regional map(s) at larger scale(s)

- Region 1 is shown enlarged in figure 3.3-4
- Region 2 is shown enlarged in figure 3.3-6
- Region 3 is shown enlarged in figure 3.3-8
- Region 4 is shown enlarged in figure 3.3-9

FIGURE 3.3-2 (continued) MAXIMUM CONSIDERED EARTHQUAKE GROUND MOTION FOR THE CONTERMINOUS UNITED STATES OF 1.0 SEC SPECTRAL RESPONSE ACCELERATION (5% OF CRITICAL DAMPING), SITE CLASS B

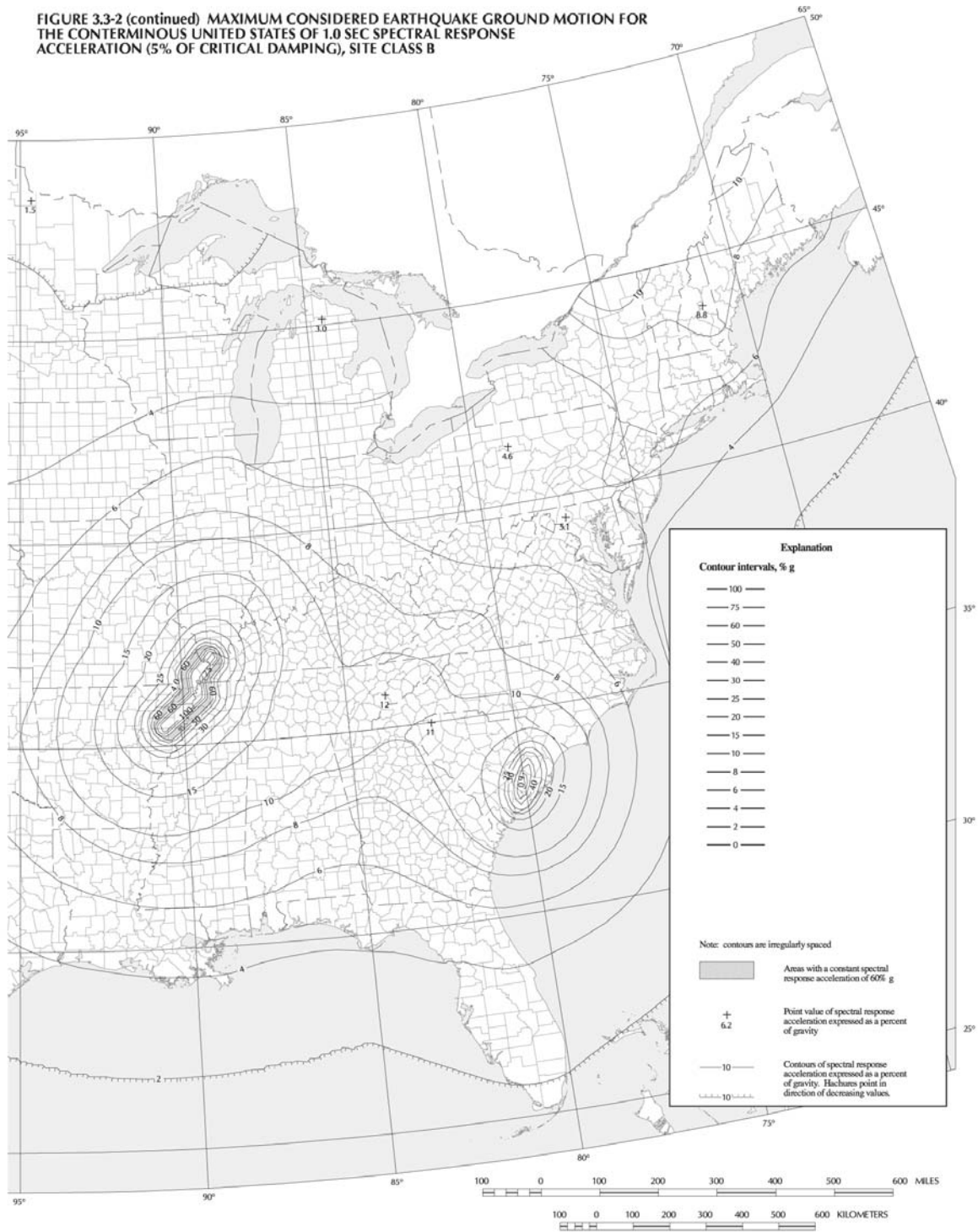
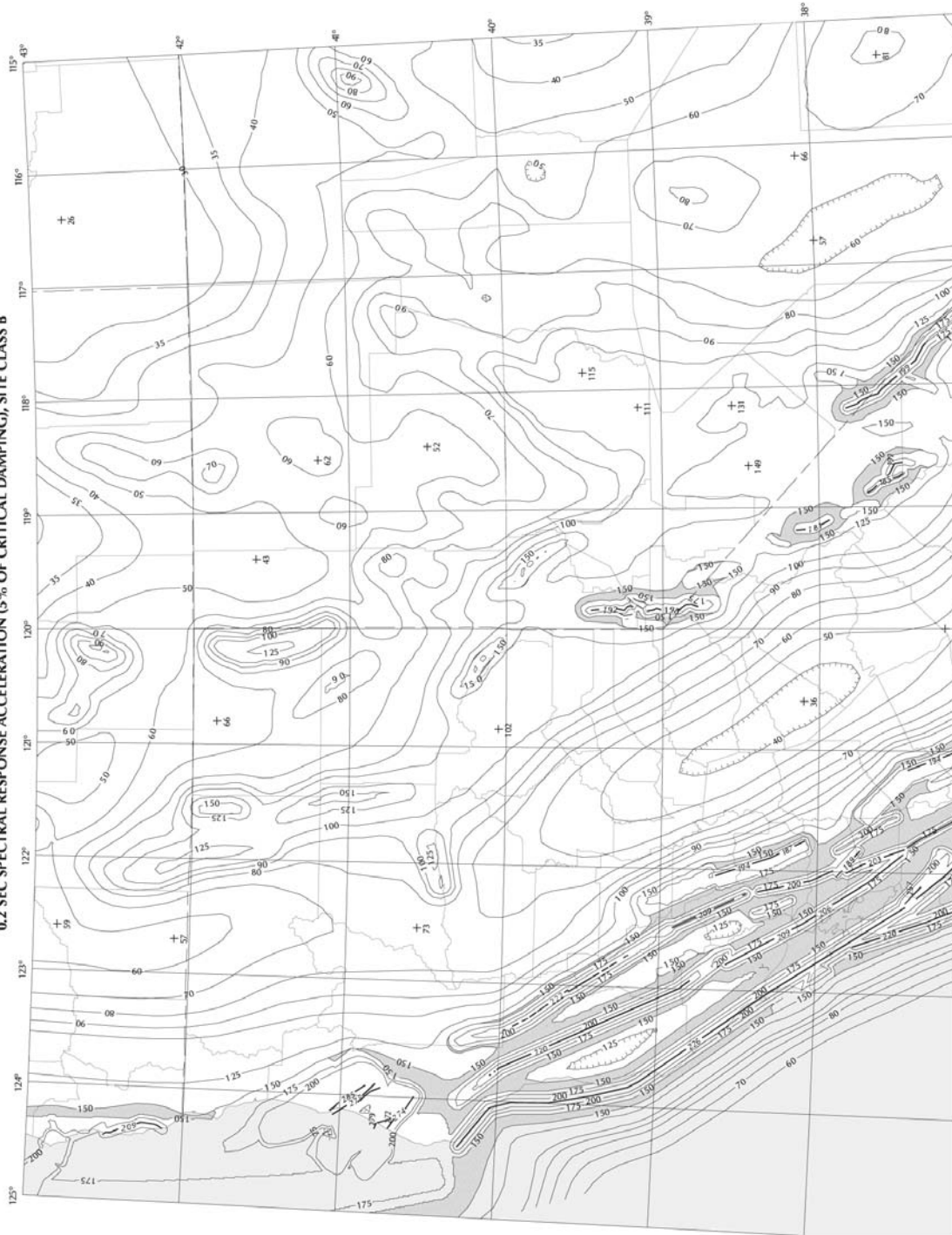

FIGURE 3.3-3. MAXIMUM CONSIDERED EARTHQUAKE GROUND MOTION FOR REGION 1 OF 0.2 SEC SPECTRAL RESPONSE ACCELERATION (5% OF CRITICAL DAMPING), SITE CLASS B



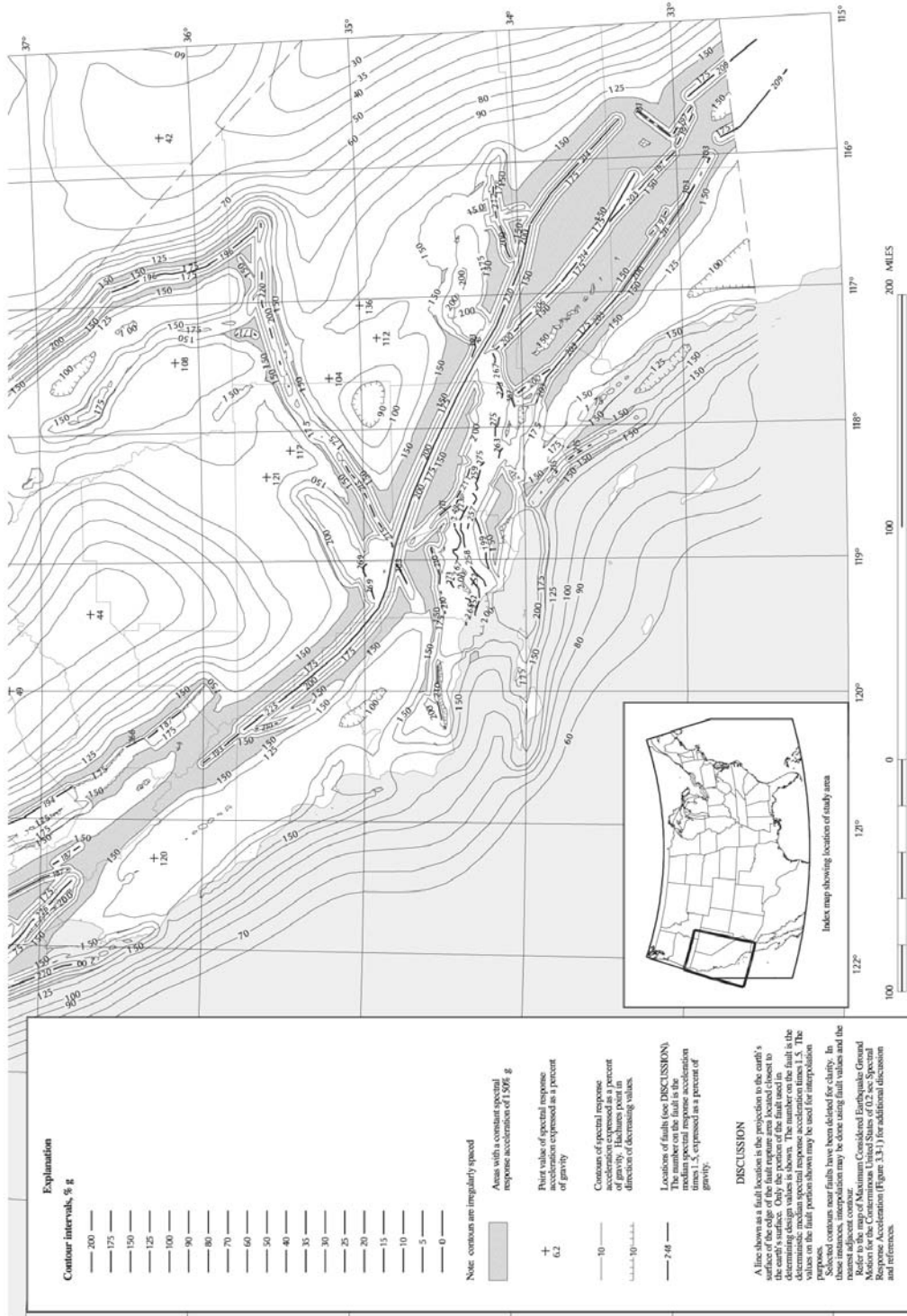
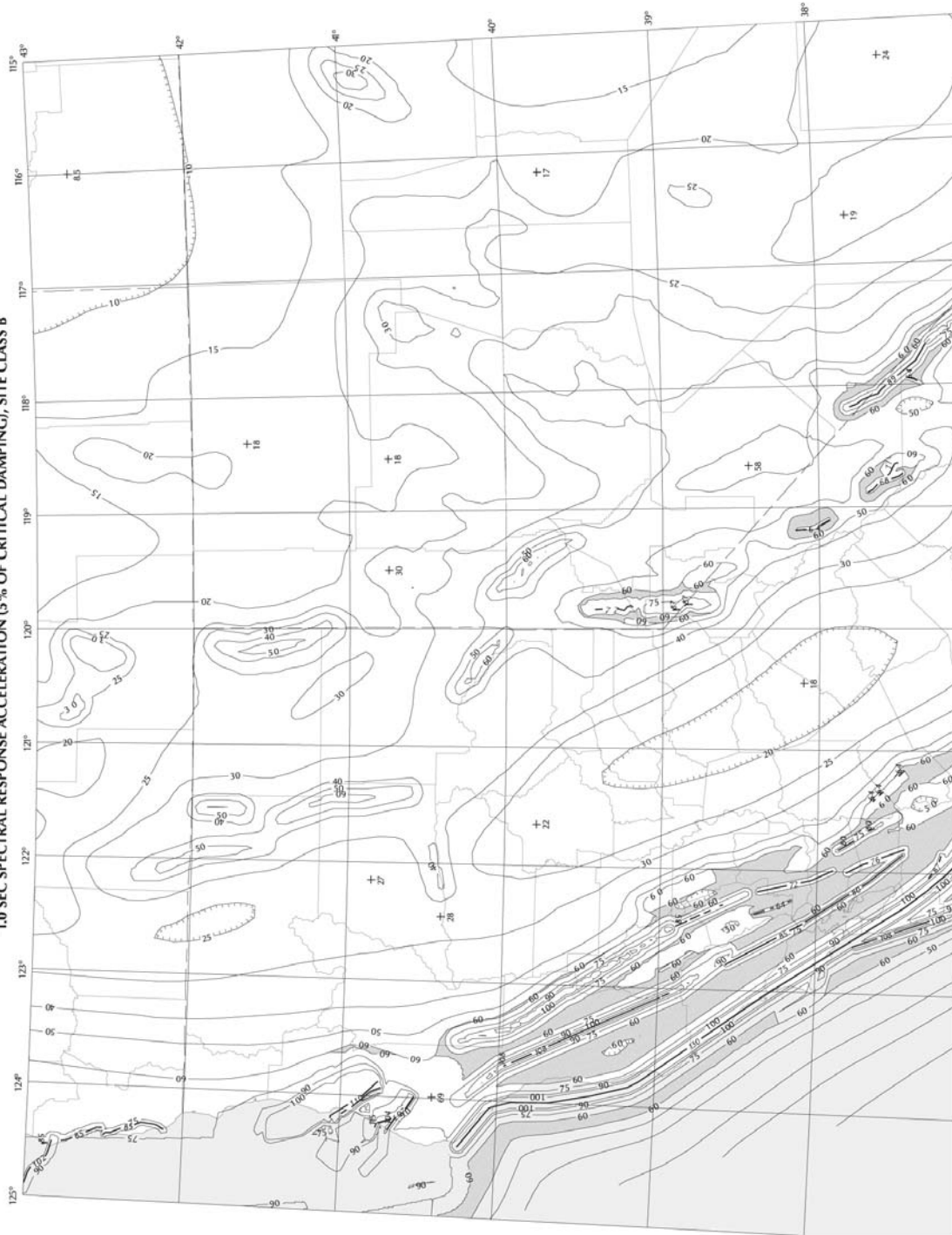

FIGURE 3.3-3 (continued) MAXIMUM CONSIDERED EARTHQUAKE GROUND MOTION FOR REGION 1 OF 0.2 SEC SPECTRAL RESPONSE ACCELERATION (5% OF CRITICAL DAMPING), SITE CLASS B

FIGURE 3.3-4. MAXIMUM CONSIDERED EARTHQUAKE GROUND MOTION FOR REGION 1 OF 1.0 SEC SPECTRAL RESPONSE ACCELERATION (5% OF CRITICAL DAMPING), SITE CLASS B



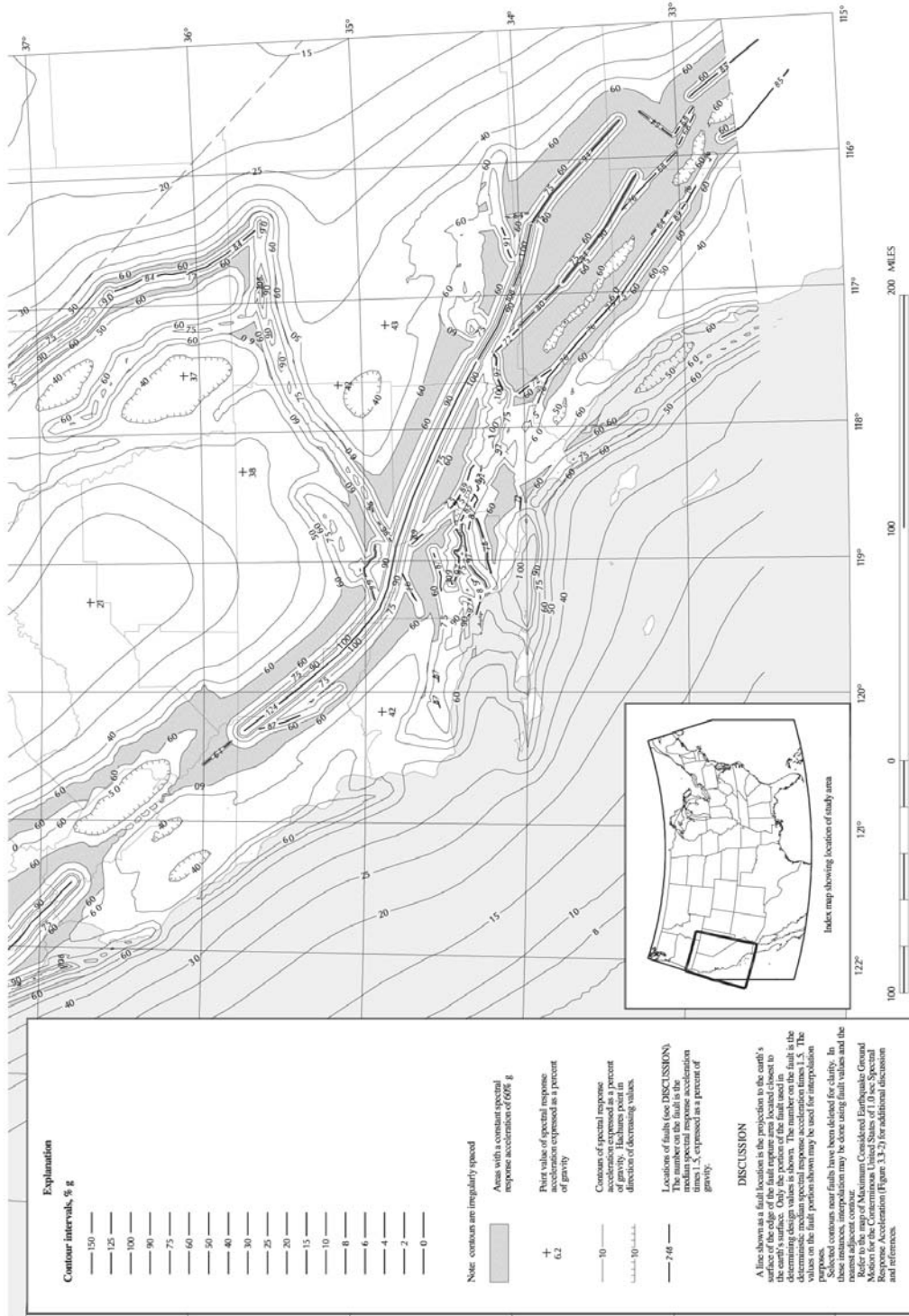

FIGURE 3.3-4 (continued) MAXIMUM CONSIDERED EARTHQUAKE GROUND MOTION FOR REGION 1 OF 1.0 SEC SPECTRAL RESPONSE ACCELERATION (5% OF CRITICAL DAMPING), SITE CLASS B

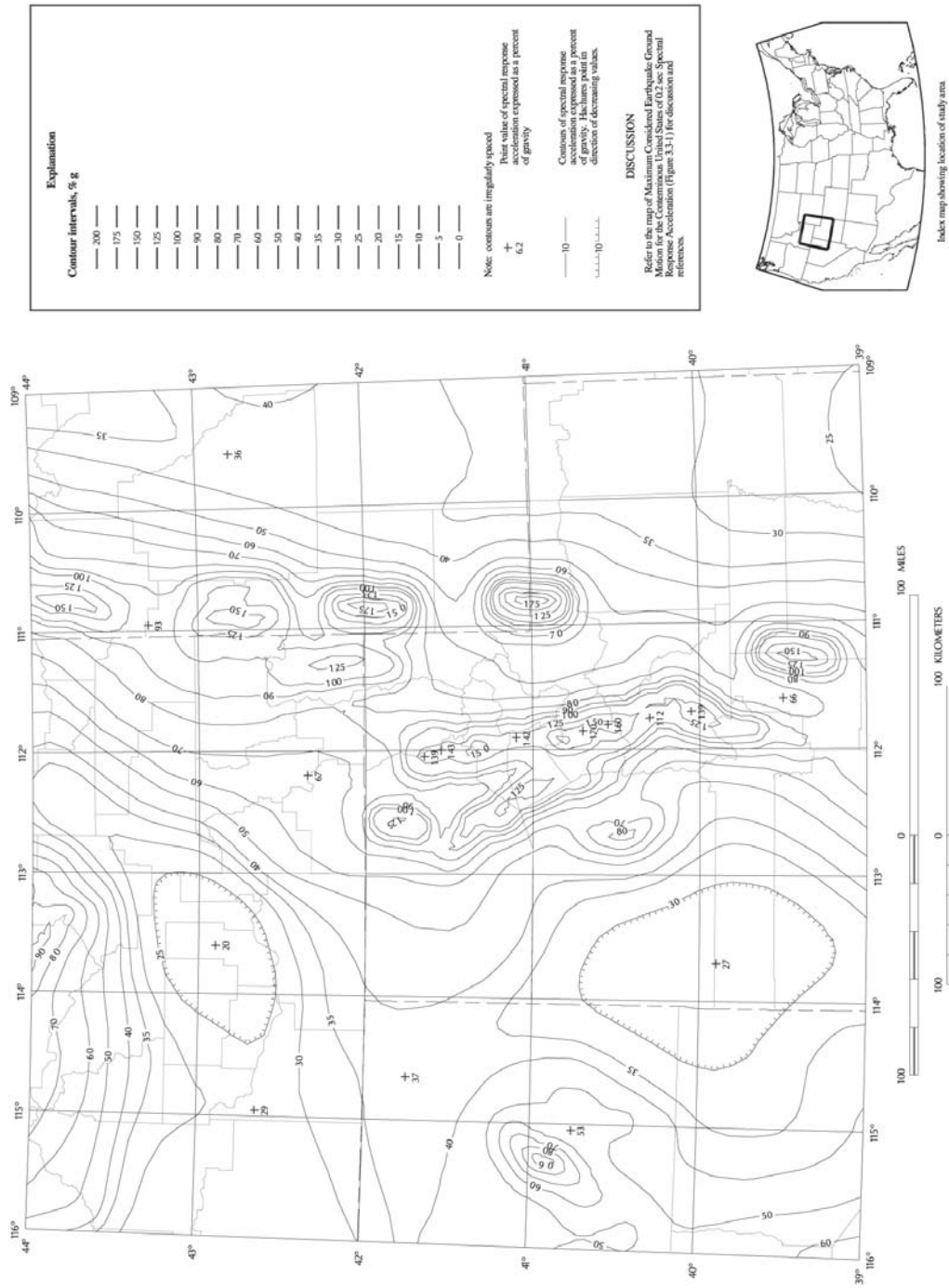

FIGURE 3.3-5 MAXIMUM CONSIDERED EARTHQUAKE GROUND MOTION FOR REGION 2 OF 0.2 SEC SPECTRAL RESPONSE ACCELERATION (5% OF CRITICAL DAMPING), SITE CLASS B

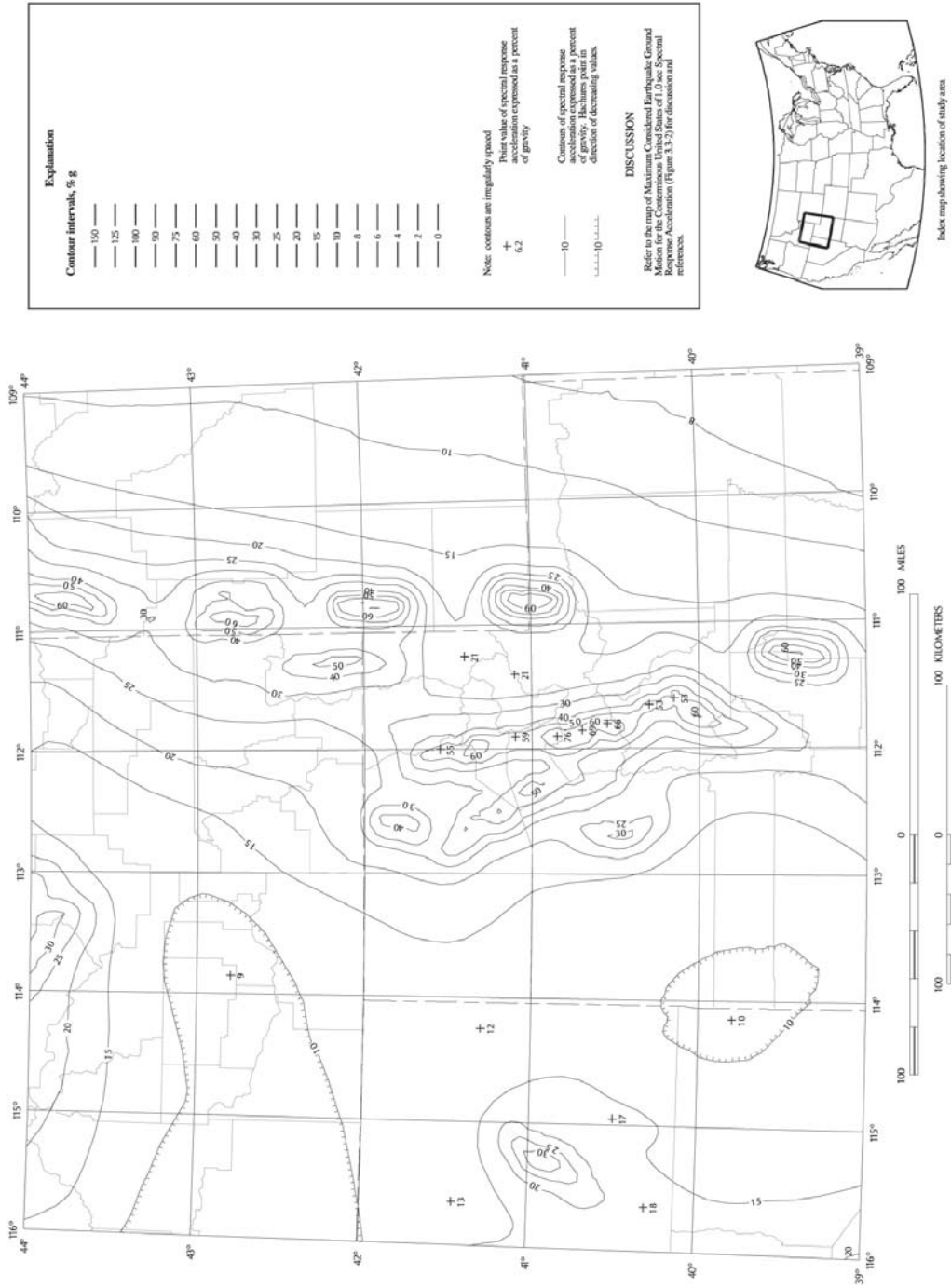

FIGURE 3.3-6 MAXIMUM CONSIDERED EARTHQUAKE GROUND MOTION FOR REGION 2 OF 1.0 SEC SPECTRAL RESPONSE ACCELERATION (5% OF CRITICAL DAMPING), SITE CLASS B

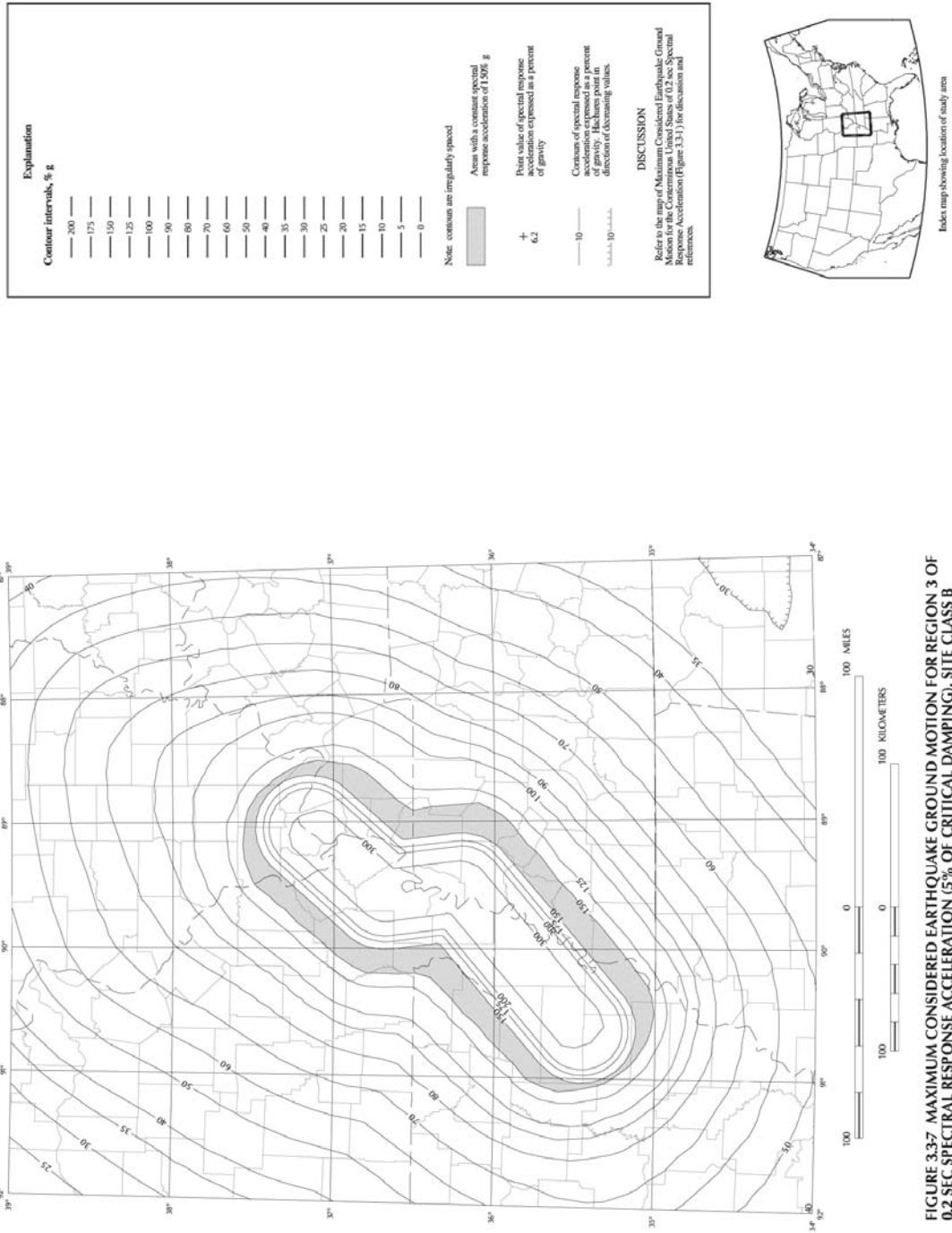

FIGURE 3.3.7 MAXIMUM CONSIDERED EARTHQUAKE GROUND MOTION FOR REGION 3 OF 0.2 SEC SPECTRAL RESPONSE ACCELERATION (5% OF CRITICAL DAMPING), SITE CLASS B

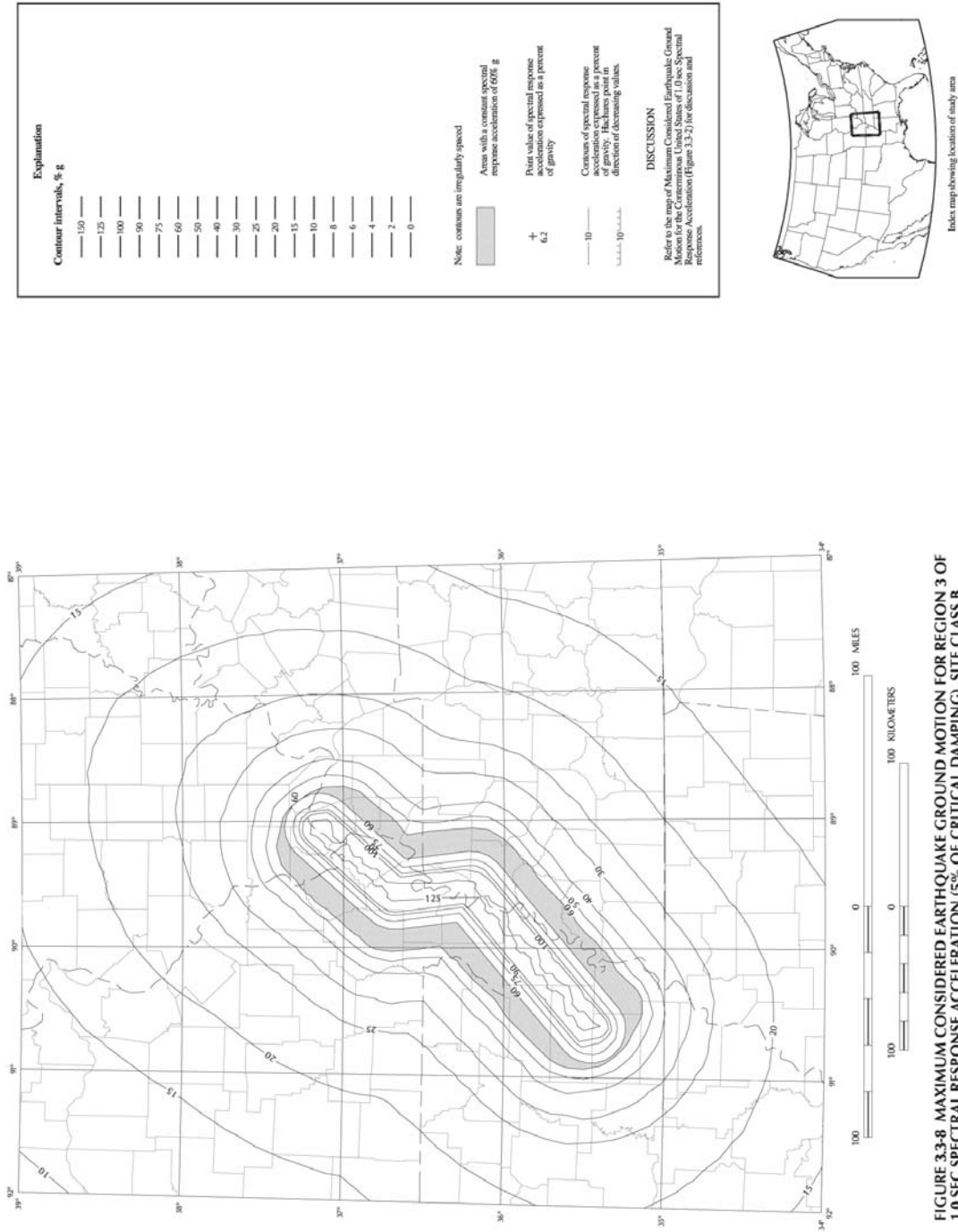

FIGURE 3.3-8 MAXIMUM CONSIDERED EARTHQUAKE GROUND MOTION FOR REGION 3 OF 1.0 SEC SPECTRAL RESPONSE ACCELERATION (5% OF CRITICAL DAMPING), SITE CLASS B

FIGURE 3.3-9 MAXIMUM CONSIDERED EARTHQUAKE GROUND MOTION FOR REGION 4 OF 0.2 AND 1.0 SEC SPECTRAL RESPONSE ACCELERATION (5% OF CRITICAL DAMPING), SITE CLASS B

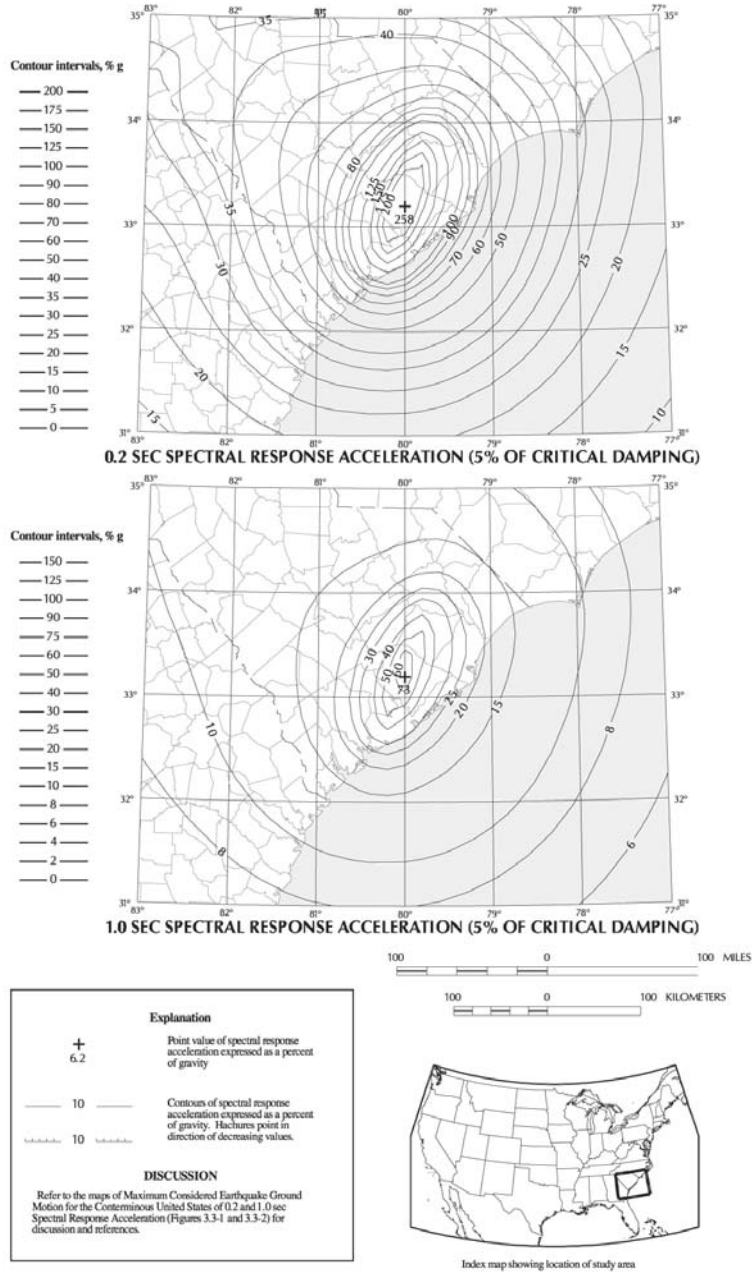
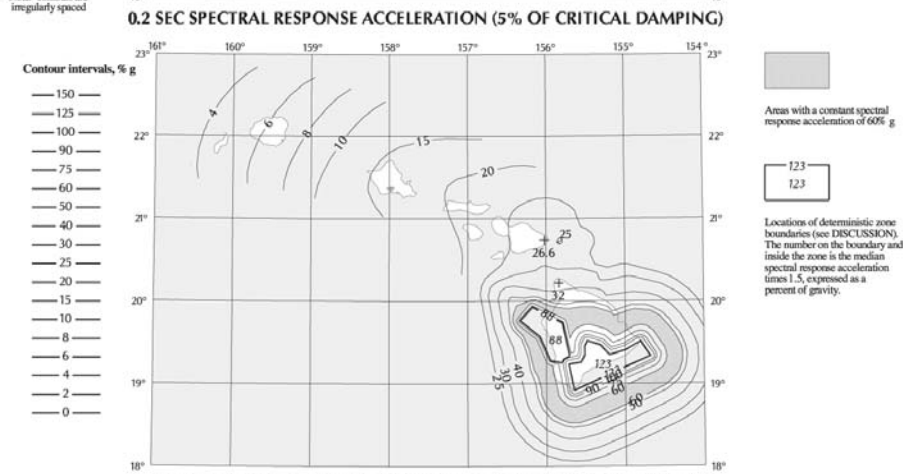

FIGURE 3.3-10 MAXIMUM CONSIDERED EARTHQUAKE GROUND MOTION FOR HAWAII OF 0.2 AND 1.0 SEC SPECTRAL RESPONSE ACCELERATION (5% OF CRITICAL DAMPING), SITE CLASS B



Explanation

+ 6.2 Point value of spectral response acceleration expressed as a percent of gravity

— 10 — Contours of spectral response acceleration expressed as a percent of gravity. Hatchures point in direction of decreasing values.

DISCUSSION

The acceleration values contoured on this map are for the random horizontal component of acceleration. For design purposes, the reference site condition for the map is to be taken as Site Class B.

The two areas shown as zone boundaries are the projection to the earth's surface of horizontal rupture planes at 9 km depth. Spectral accelerations are constant within the boundaries of the zones. The number on the boundary and inside the zone is the median spectral response acceleration times 1.5.

Leyendecker, Frankel, and Rukstales (2001, 2004) have prepared a CD-ROM that contains software to allow determination of Site Class B map values by latitude-longitude. The software on the CD contains site coefficients that allow the user to adjust map values for different Site Classes. Additional maps at different scales are also included on the CD. The CD was prepared using the same data as that used to prepare the Maximum Considered Earthquake Ground Motion maps.

The National Seismic Hazard Mapping Project Web Site, <http://qazmaps.usgs.gov>, contains electronic versions of this map and others. Documentation, gridded values, and Arc/INFO coverages used to make the maps are also available.

Map prepared by U.S. Geological Survey.

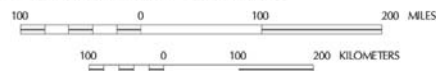

REFERENCES

Building Seismic Safety Council 2004, NEHRP Recommended Provisions for Seismic Regulations for New Buildings and other Structures, Part 1 - Provisions, FEMA 450

Building Seismic Safety Council 2004, NEHRP Recommended Provisions for Seismic Regulations for New Buildings and other Structures, Part 2 - Commentary, FEMA 450

Klein, F., Frankel, A., Mueller, C., Wesson, R. and Okubo, P., 2001, Seismic hazard in Hawaii: high rate of large earthquakes and probabilistic ground-motion maps, *Bull. Seism. Soc. Am.*, v. 91, pp. 479-498.

Klein, F., Frankel, A., Mueller, C., Wesson, R. and Okubo, P., 1998, Seismic-Hazard Maps for Hawaii, Sheet 2 - 2% Probability of Exceedance in 50 Years for Peak Horizontal Acceleration and Horizontal Spectral Response Acceleration for 0.2, 0.3, and 1.0 Second Periods U.S. Geological Survey Geologic Investigation Series F-2724, scale 1:2,000,000.

Leyendecker, E., Frankel, A., and Rukstales, K., 2001, Seismic Design Parameters, U.S. Geological Survey Open-File Report 01-437.

Leyendecker, E., Frankel, A., and Rukstales, K., 2004, Seismic Design Parameters, U.S. Geological Survey Open-File Report (in progress).

National Seismic Hazard Mapping Project Web Site, <http://qazmaps.usgs.gov>, U.S. Geological Survey.

FIGURE 3.3-13 MAXIMUM CONSIDERED EARTHQUAKE GROUND MOTION FOR PUERTO RICO, CULEBRA, VIEQUES, ST. THOMAS, ST. JOHN, AND ST. CROIX OF 0.2 AND 1.0 SEC SPECTRAL RESPONSE ACCELERATION (5% OF CRITICAL DAMPING), SITE CLASS B

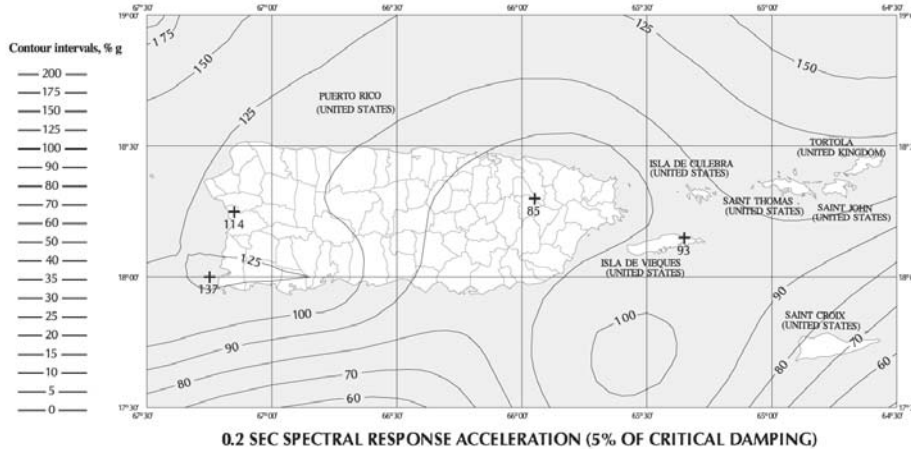

0.2 SEC SPECTRAL RESPONSE ACCELERATION (5% OF CRITICAL DAMPING)

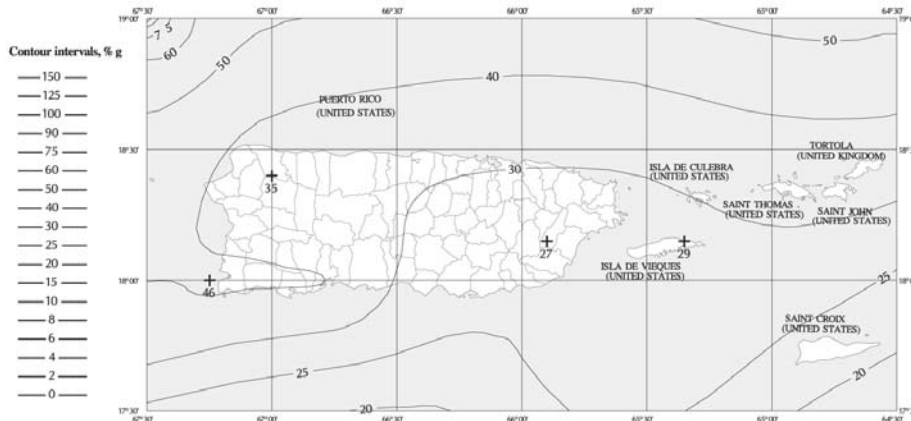

1.0 SEC SPECTRAL RESPONSE ACCELERATION (5% OF CRITICAL DAMPING)

Explanation	
+	Point value of spectral response acceleration expressed as a percent of gravity
—	Contours of spectral response acceleration expressed as a percent of gravity
.....	Contours of spectral response acceleration expressed as a percent of gravity. Hashes point in direction of decreasing values.

DISCUSSION

The acceleration values contoured on this map are for the random horizontal component of acceleration. For design purposes, the reference site condition for the map is to be taken as Site Class B.

Leyendecker, Frankel, and Rukstales (2001, 2004) have prepared a CD-ROM that contains software to allow determination of Site Class B map values by latitude-longitude. The software on the CD contains site coefficients that allow the user to adjust map values for different Site Classes. Additional maps at different scales are also included on the CD. The CD was prepared using the same data as that used to prepare the Maximum Considered Earthquake Ground Motion maps.

The National Seismic Hazard Mapping Project Web Site, <http://eqhazmaps.usgs.gov>, contains electronic versions of this map and others. Documentation, gridded values, and Arc/INFO coverages used to make the maps are also available.

Map prepared by U.S. Geological Survey.



REFERENCES

Building Seismic Safety Council 2004, NEHRP Recommended Provisions for Seismic Regulations for New Buildings and other Structures, Part 1 - Provisions, FEMA 450.

Building Seismic Safety Council 2004, NEHRP Recommended Provisions for Seismic Regulations for New Buildings and other Structures, Part 2 - Commentary, FEMA 450.

Leyendecker, E., Frankel, A., and Rukstales, K., 2001, Seismic Design Parameters, U.S. Geological Survey Open-File Report 01-437.

Leyendecker, E., Frankel, A., and Rukstales, K., 2004, Seismic Design Parameters, U.S. Geological Survey Open-File Report (in progress).

Mueller, C., Frankel, A., Petersen, M., and Leyendecker, E., 2003, Documentation for 2003 USGS Seismic Hazard Maps for Puerto Rico and the U.S. Virgin Islands, U.S. Geological Survey Open-File Report 03-379.

Mueller, C., Frankel, A., Petersen, M., and Leyendecker, E., 2004, Seismic-Hazard Maps for Puerto Rico and the U.S. Virgin Islands, Sheet 2 - 2% Probability of Exceedance in 50 Years for Peak Horizontal Acceleration and Horizontal Spectral Response Acceleration for 0.2, 0.3, and 1.0 Second Periods, U.S. Geological Survey Geologic Investigation Series (in progress).

National Seismic Hazard Mapping Project Web Site, <http://eqhazmaps.usgs.gov>, U.S. Geological Survey.

FIGURE 3.3-14 MAXIMUM CONSIDERED EARTHQUAKE GROUND MOTION FOR GUAM AND TUTUILA OF 0.2 AND 1.0 SEC SPECTRAL RESPONSE ACCELERATION (5% OF CRITICAL DAMPING), SITE CLASS B

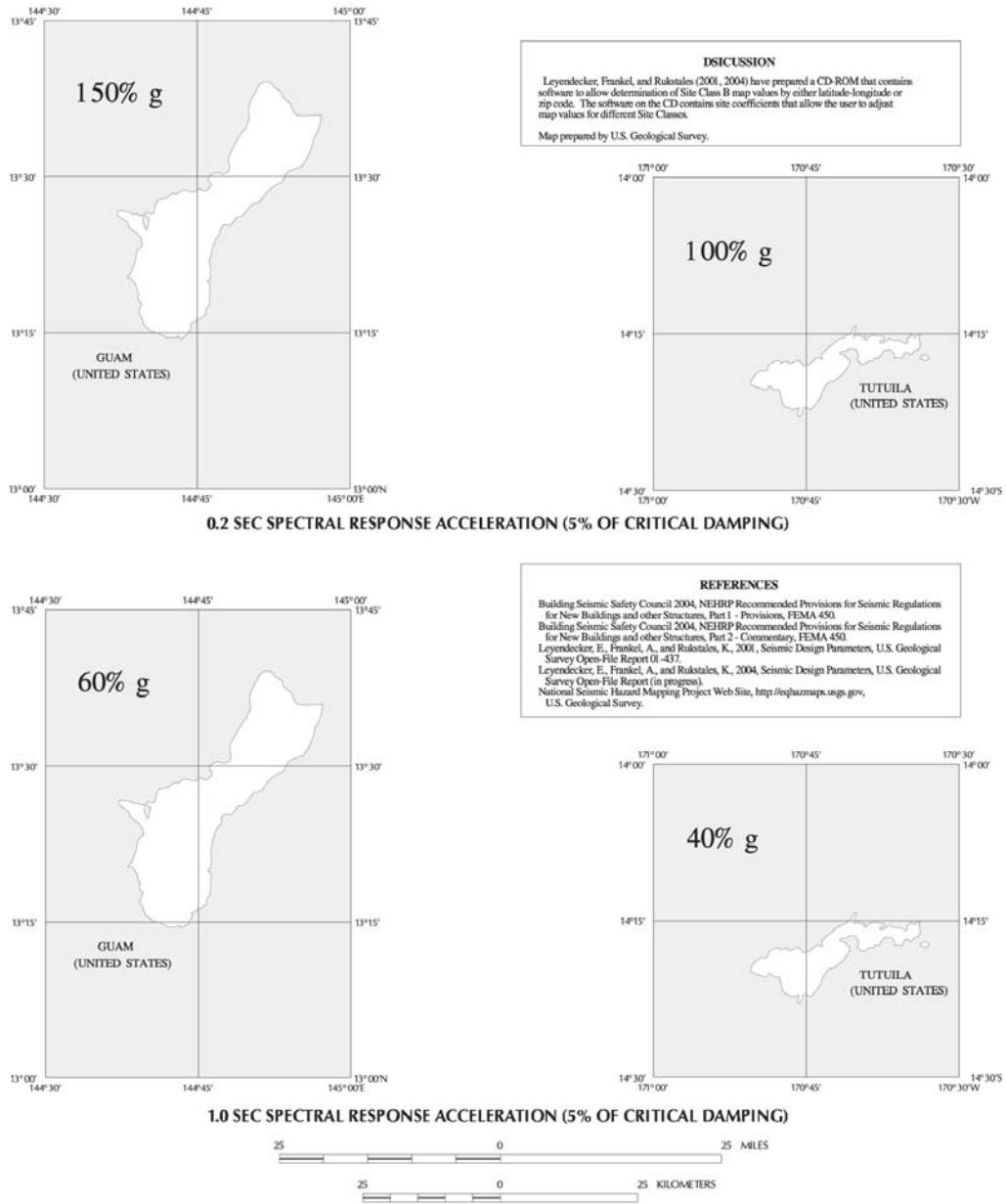

Table 3.3-2 Values of Site Coefficient F_v

Site Class	Mapped MCE Spectral Response Acceleration Parameter at 1 Second Period ^a				
	$S_I \leq 0.1$	$S_I = 0.2$	$S_I = 0.3$	$S_I = 0.4$	$S_I \geq 0.5$
A	0.8	0.8	0.8	0.8	0.8
B	1.0	1.0	1.0	1.0	1.0
C	1.7	1.6	1.5	1.4	1.3
D	2.4	2.0	1.8	1.6	1.5
E	3.5	3.2	2.8	2.4	2.4
F	— ^b	— ^b	— ^b	— ^b	— ^b

^a Use straight line interpolation for intermediate values of S_I .
^b Site-specific geotechnical investigation and dynamic site response analyses shall be performed.

3.3.3 Design acceleration parameters. The parameters S_{DS} and S_{DI} shall be determined from Eq. 3.3-3 and 3.3-4, respectively:

$$S_{DS} = \frac{2}{3} S_{MS} \quad (3.3-3)$$

and

$$S_{DI} = \frac{2}{3} S_{MI} \quad (3.3-4)$$

3.3.4 Design response spectrum. Where a design response spectrum is required by these *Provisions* and site-specific procedures are not used, the design response spectrum shall be developed as indicated in Figure 3.3-15 and as follows:

1. For periods less than or equal to T_0 , S_a shall be taken as given by Eq. 3.3-5:

$$S_a = 0.6 \frac{S_{DS}}{T_0} T + 0.4 S_{DS} \quad (3.3-5)$$

2. For periods greater than or equal to T_0 and less than or equal to T_S , S_a shall be taken as equal to S_{DS} .
3. For periods greater than T_S and less than or equal to T_L , S_a shall be taken as given by Eq. 3.3-6:

$$S_a = \frac{S_{DI}}{T} \quad (3.3-6)$$

4. For periods greater than T_L , S_a shall be taken as given by Eq. 3.3-7.

$$S_a = \frac{S_{DI} T_L}{T^2} \quad (3.3-7)$$

where:

S_{DS} = the design spectral response acceleration parameter at short periods

S_{DI} = the design spectral response acceleration parameter at 1 second period

T = the fundamental period of the structure (sec)

T_0 = $0.2 S_{DI} / S_{DS}$

T_S = S_{DI} / S_{DS}

T_L = Long-period transition period shown in Figure 3.3-16 (conterminous U.S. except California), Figure 3.3-17 (California), Figure 3.3-18 (Alaska), Figure 3.3-19 (Hawaii), Figure 3.3-20 (Puerto Rico), and Figure 3.3-21 (Guam and Tutuila).

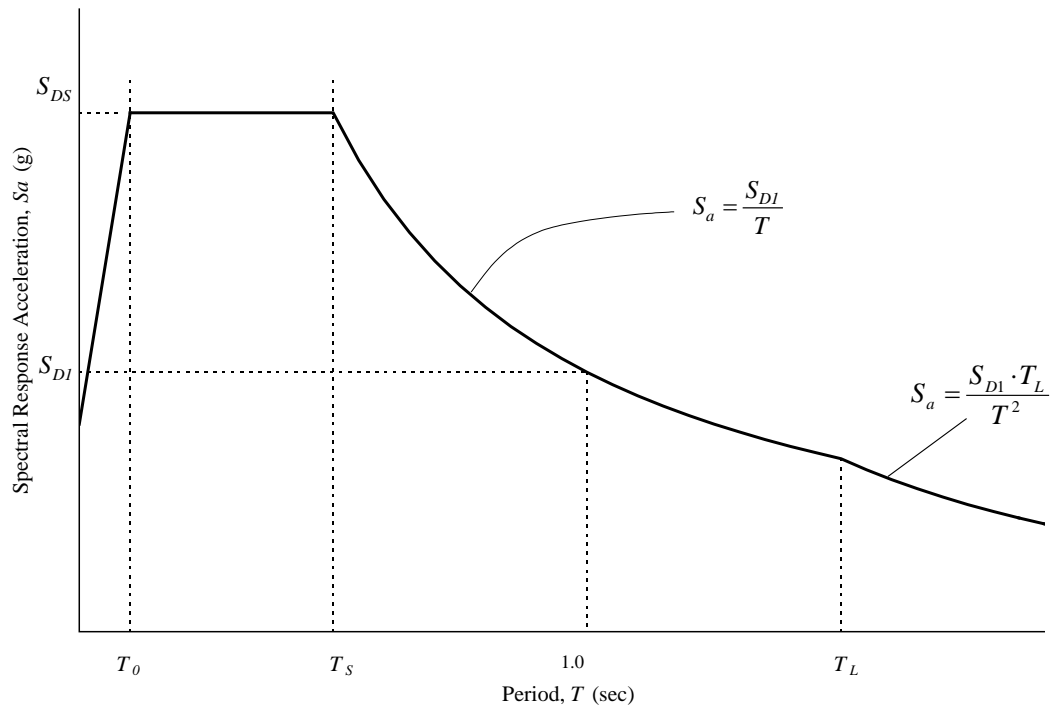

Figure 3.3-15 Long-Period transition Period.

FIGURE 3.3-16 LONG-PERIOD TRANSITION PERIOD, T_L (sec),
FOR THE CONTERMINOUS UNITED STATES

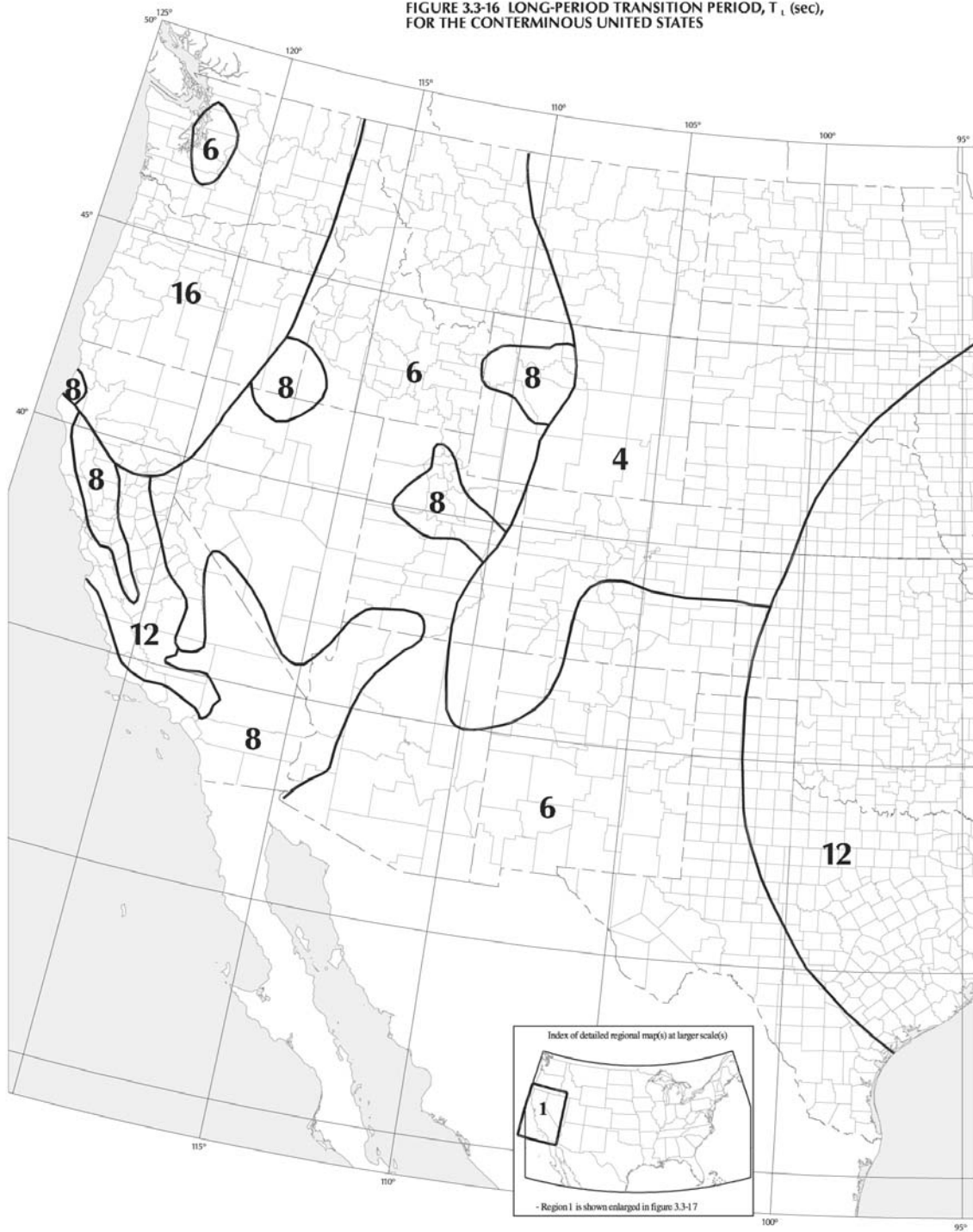
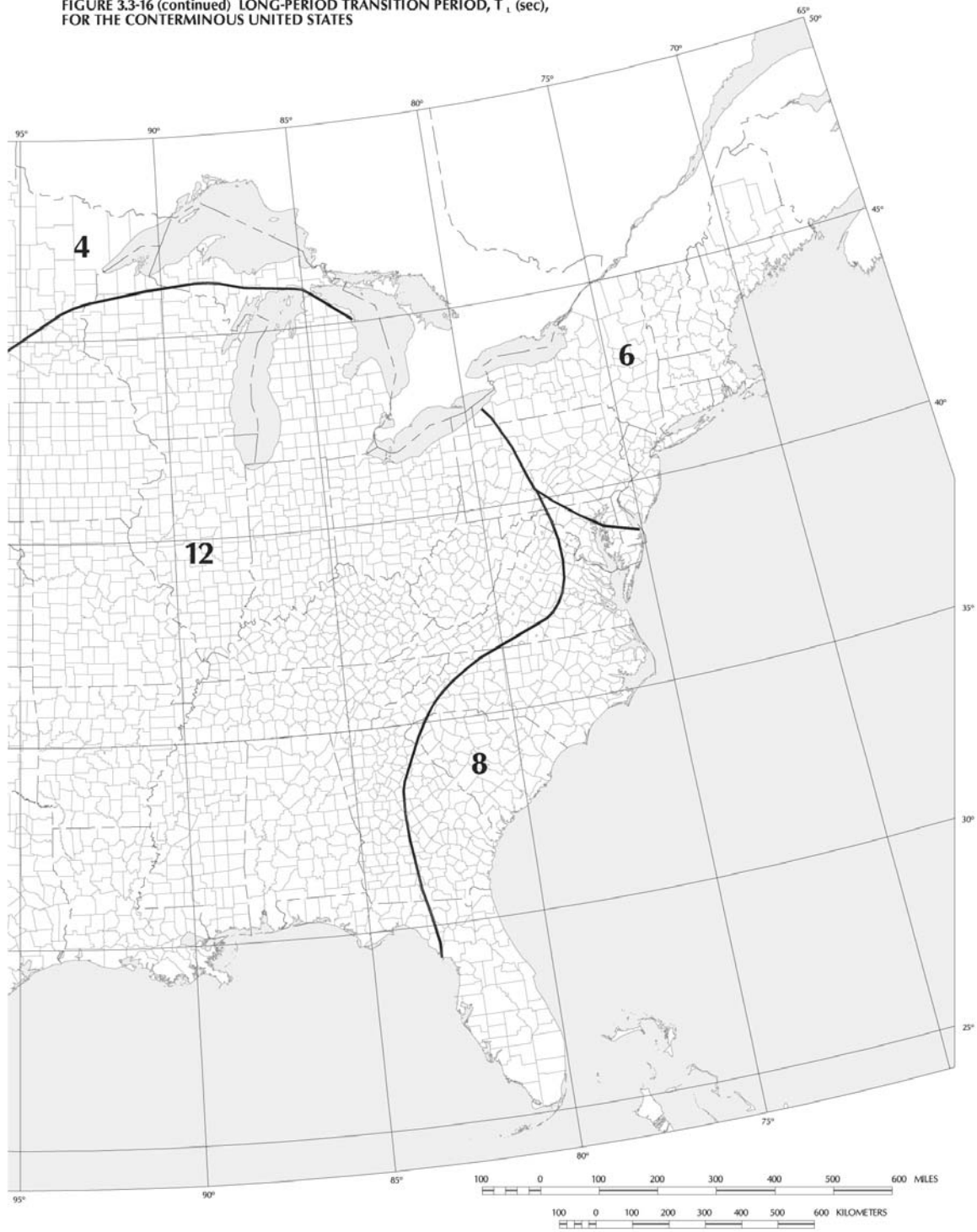
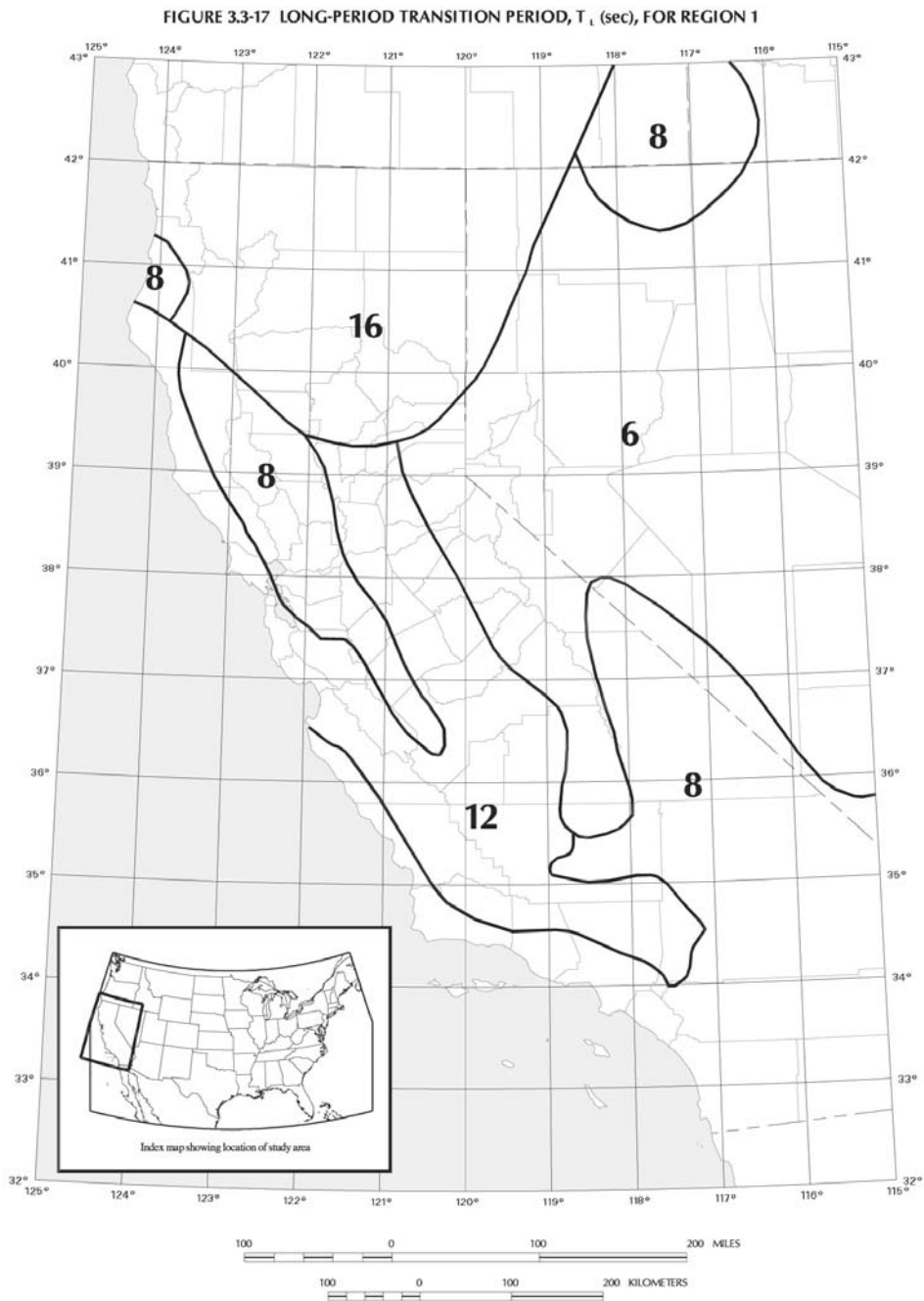
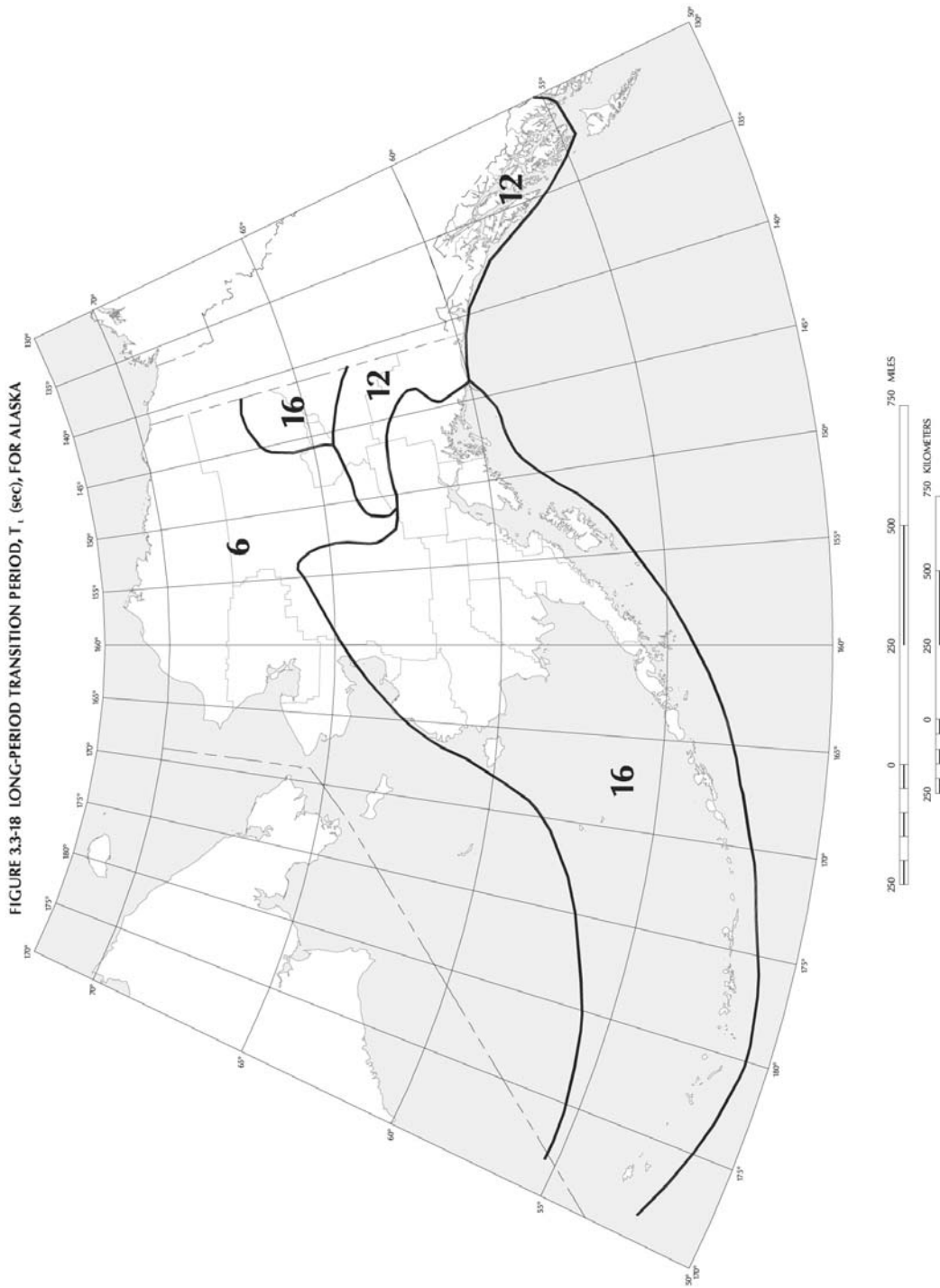

FIGURE 3.3-16 (continued) LONG-PERIOD TRANSITION PERIOD, T_L (sec),
FOR THE CONTERMINOUS UNITED STATES







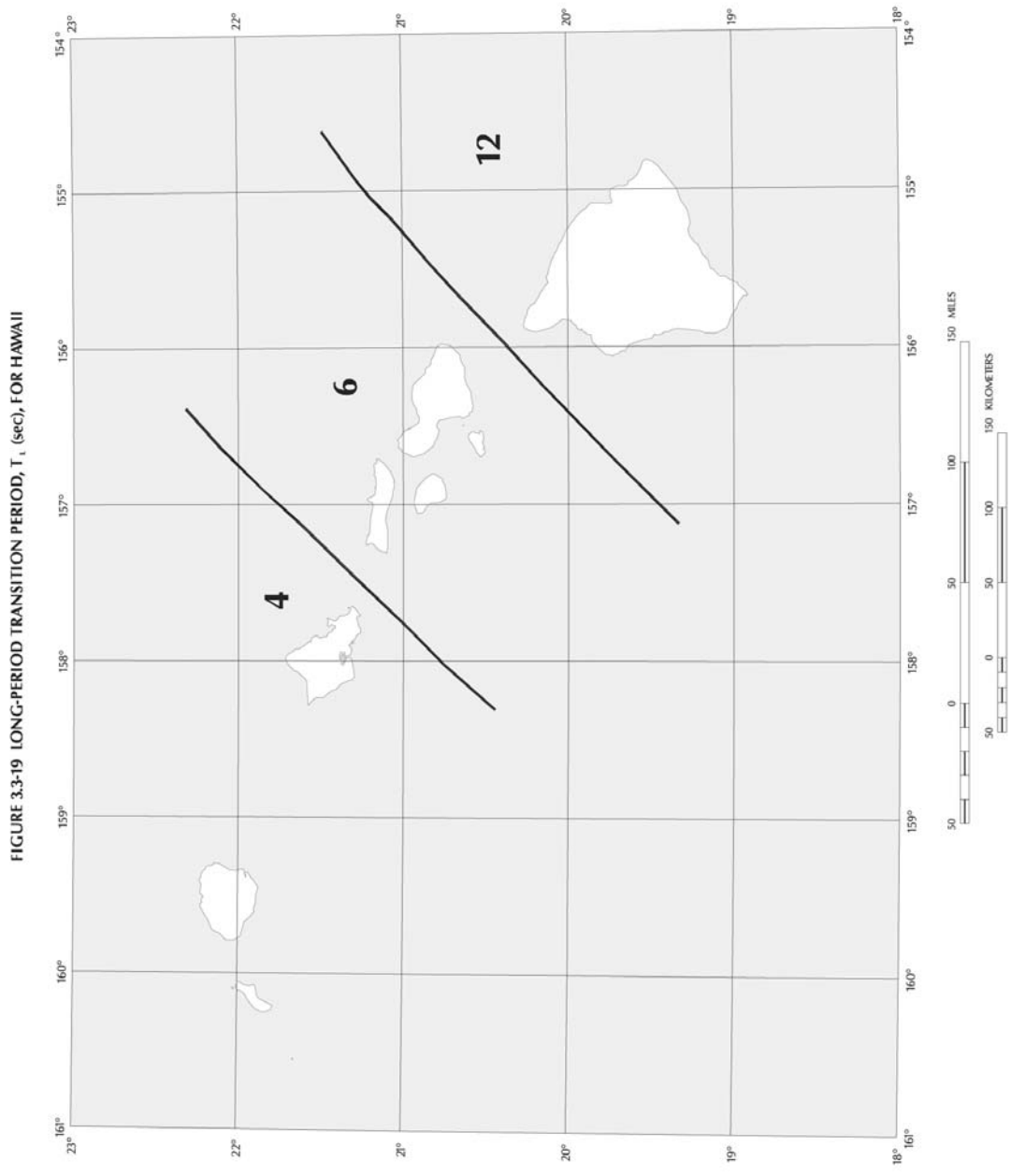

FIGURE 3.3-20 LONG-PERIOD TRANSITION PERIOD, T_i (sec), FOR PUERTO RICO, CULEBRA, VIEQUES, ST. THOMAS, ST. JOHN, AND ST. CROIX

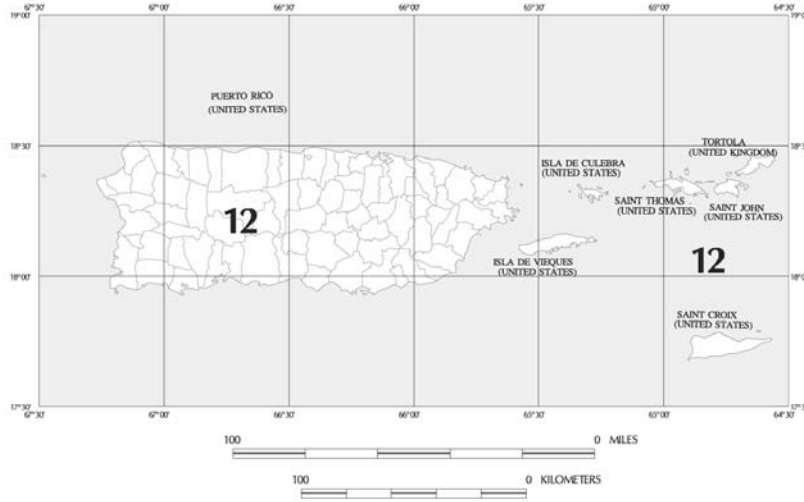
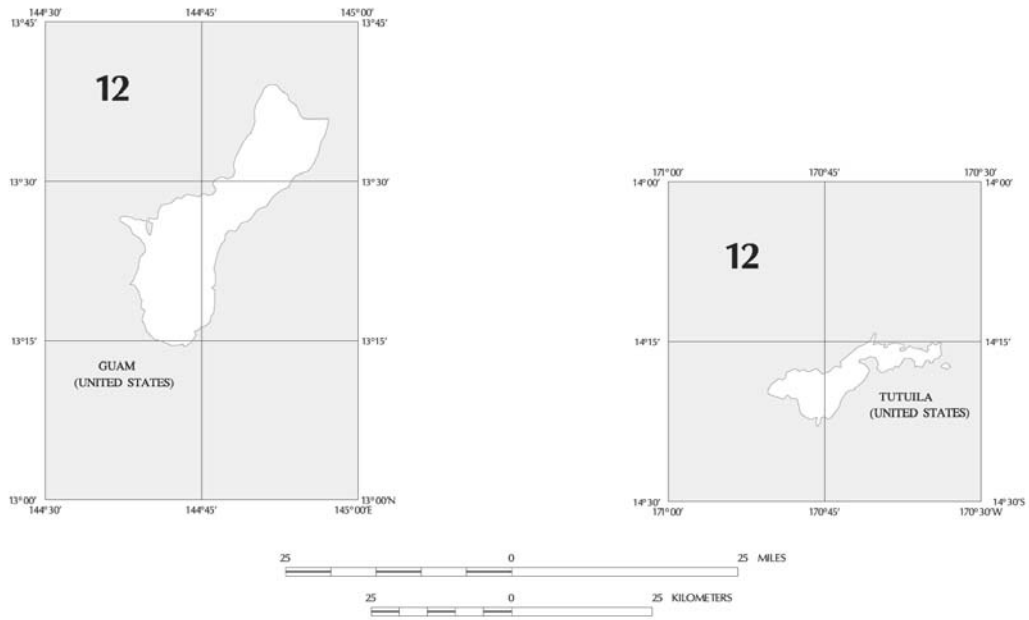

FIGURE 3.3-21 LONG-PERIOD TRANSITION PERIOD, T_i (sec), FOR GUAM AND TUTUILA



3.4 SITE-SPECIFIC PROCEDURE

A site-specific study shall account for the regional tectonic setting, geology, and seismicity, the expected recurrence rates and maximum magnitudes of earthquakes on known faults and source zones, the characteristics of ground motion attenuation, near-fault effects if any on ground motions, and the effects of subsurface site conditions on ground motions. The study shall incorporate current scientific interpretations, including uncertainties, for models and parameter values for seismic sources and ground motions. The study shall be documented in a report.

3.4.1 Probabilistic maximum considered earthquake. Where site-specific procedures are utilized, the probabilistic maximum considered earthquake ground motion shall be taken as that motion represented by a 5-percent-damped acceleration response spectrum having a 2 percent probability of exceedance in a 50 year period.

3.4.2 Deterministic maximum considered earthquake. The deterministic maximum considered earthquake spectral response acceleration at each period shall be taken as 150 percent of the largest median 5-percent-damped spectral response acceleration computed at that period for characteristic earthquakes on all known active faults within the region. For the purposes of these *Provisions*, the ordinates of the deterministic maximum considered earthquake ground motion response spectrum shall not be taken lower than the corresponding ordinates of the response spectrum determined in accordance with Figure 3.4-1, where F_a and F_v are determined using Tables 3.3-1 and 3.3-2, with the value of S_S taken as 1.5 and the value of S_I taken as 0.6.

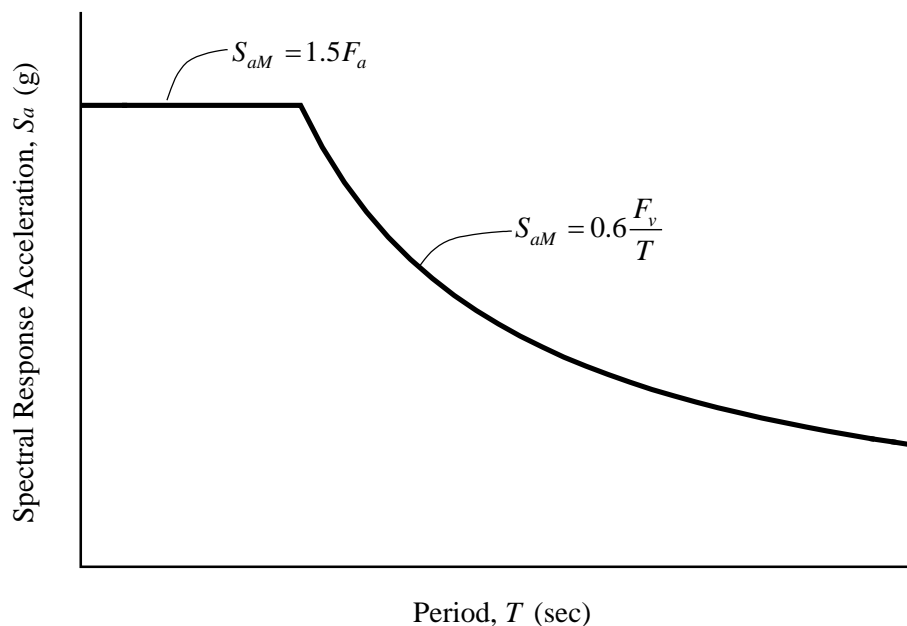

Figure 3.4-1 Deterministic Lower Limit on Maximum Considered Earthquake

3.4.3 Site-specific maximum considered earthquake. The site-specific maximum considered earthquake spectral response acceleration at any period, S_{aM} , shall be taken as the lesser of the spectral response accelerations from the probabilistic maximum considered earthquake ground motion of Sec. 3.4.1 and the deterministic maximum considered earthquake ground motion of Sec. 3.4.2.

3.4.4 Design response spectrum. Where site-specific procedures are used to determine the maximum considered earthquake ground motion, the design spectral response acceleration at any period shall be determined from Eq. 3.4-1:

$$S_a = \frac{2}{3} S_{aM} \quad (3.4-1)$$

and shall be greater than or equal to 80 percent of S_a determined in accordance with Sec. 3.3.4. For sites classified as Site Class F requiring site-specific evaluations (Note b to Tables 3.3-1 and 3.3-2 and Sec. 3.5.1), the design spectral response acceleration at any period shall be greater than or equal to 80 percent of S_a determined for Site Class E in accordance with Sec. 3.3.4.

3.4.5 Design acceleration parameters. Where the site-specific procedure is used to determine the design response spectrum in accordance with Section 3.4.4, the parameter S_{DS} shall be taken as the spectral acceleration, S_a , obtained from the site-specific spectrum at a period of 0.2 second, except that it shall not be taken as less than 90 percent of the peak spectral acceleration, S_a , at any period larger than 0.2 second. The parameter S_{DI} shall be taken as the greater of the spectral acceleration, S_a , at a period of 1 second or two times the spectral acceleration, S_a , at a period 2 seconds. The parameters S_{MS} and S_{MI} shall be taken as 1.5 times S_{DS} and S_{DI} , respectively. The values so obtained shall not be taken as less than 80 percent of the values obtained from the general procedure of Section 3.3.

3.5 SITE CLASSIFICATION FOR SEISMIC DESIGN

Where the soil properties are not known in sufficient detail to determine the Site Class in accordance with Sec. 3.5.1, it shall be permitted to assume Site Class D unless the authority having jurisdiction determines that Site Class E or F could apply at the site or in the event that Site Class E or F is established by geotechnical data.

3.5.1 Site Class definitions. The Site Classes are defined as follows:

- A Hard rock with measured shear wave velocity, $\bar{v}_s > 5,000$ ft/sec (1500 m/s)
- B Rock with $2,500$ ft/sec $< \bar{v}_s \leq 5,000$ ft/sec (760 m/s $< \bar{v}_s \leq 1500$ m/s)
- C Very dense soil and soft rock with $1,200$ ft/sec $< \bar{v}_s \leq 2,500$ ft/sec (360 m/s $< \bar{v}_s \leq 760$ m/s) or with either $\bar{N} > 50$ or $\bar{s}_u > 2,000$ psf (100 kPa)
- D Stiff soil with 600 ft/sec $\leq \bar{v}_s \leq 1,200$ ft/sec (180 m/s $\leq \bar{v}_s \leq 360$ m/s) or with either $15 \leq \bar{N} \leq 50$ or $1,000$ psf $\leq \bar{s}_u \leq 2,000$ psf (50 kPa $\leq \bar{s}_u \leq 100$ kPa)
- E A soil profile with $\bar{v}_s < 600$ ft/sec (180 m/s) or with either $\bar{N} < 15$, $\bar{s}_u < 1,000$ psf, or any profile with more than 10 ft (3 m) of soft clay defined as soil with $PI > 20$, $w \geq 40$ percent, and $s_u < 500$ psf (25 kPa)
- F Soils requiring site-specific evaluations:
 1. Soils vulnerable to potential failure or collapse under seismic loading such as liquefiable soils, quick and highly sensitive clays, collapsible weakly cemented soils.

Exception: For structures having fundamental periods of vibration less than or equal to 0.5 second, site-specific evaluations are not required to determine spectral accelerations for liquefiable soils. Rather, the Site Class may be determined in accordance with Sec. 3.5.2, assuming liquefaction does not occur, and the corresponding values of F_a and F_v determined from Tables 3.3-1 and 3.3-2.
 2. Peat and/or highly organic clays ($H > 10$ ft [3 m] of peat and/or highly organic clay, where H = thickness of soil)
 3. Very high plasticity clays ($H > 25$ ft [8 m] with $PI > 75$)
 4. Very thick, soft/medium stiff clays ($H > 120$ ft [36 m]) with $s_u < 1,000$ psf (50 kPa)

The parameters used to define the Site Class are based on the upper 100 ft (30 m) of the site profile. Profiles containing distinctly different soil and rock layers shall be subdivided into those layers

designated by a number that ranges from 1 to n at the bottom where there are a total of n distinct layers in the upper 100 ft (30 m). The symbol i then refers to any one of the layers between 1 and n .

where:

v_{si} = the shear wave velocity in ft/sec (m/s).

d_i = the *thickness* of any layer (between 0 and 100 ft [30 m]).

$$\bar{v}_s = \frac{\sum_{i=1}^n d_i}{\sum_{i=1}^n \frac{d_i}{v_{si}}} \quad (3.5-1)$$

where $\sum_{i=1}^n d_i$ is equal to 100 ft (30 m).

N_i = the Standard Penetration Resistance determined in accordance with ASTM D 1586, as directly measured in the field without corrections, and shall not be taken greater than 100 blows/ft. Where refusal is met for a rock layer, N_i shall be taken as 100 blows/ft.

$$\bar{N} = \frac{\sum_{i=1}^n d_i}{\sum_{i=1}^n \frac{d_i}{N_i}} \quad (3.5-2)$$

where N_i and d_i in Eq. 3.5-2 are for cohesionless soil, cohesive soil, and rock layers.

$$\bar{N}_{ch} = \frac{d_s}{\sum_{i=1}^m \frac{d_i}{N_i}} \quad (3.5-3)$$

where N_i and d_i in Eq. 3.5-3 are for cohesionless soil layers only,

$$\text{and } \sum_{i=1}^m d_i = d_s$$

d_s = the total thickness of cohesionless soil layers in the top 100 ft (30 m).

s_{ui} = the undrained shear strength in psf (kPa), determined in accordance with ASTM D 2166 or D 2850, and shall not be taken greater than 5,000 psf (250 kPa).

$$\bar{s}_u = \frac{d_c}{\sum_{i=1}^k \frac{d_i}{s_{ui}}} \quad (3.5-4)$$

where $\sum_{i=1}^k d_i = d_c$.

d_c = the total thickness of cohesive soil layers in the top 100 ft (30 m).

PI = the plasticity index, determined in accordance with ASTM D 4318.

w = the moisture content in percent, determined in accordance with ASTM D 2216.

3.5.2 Steps for classifying a site

Step 1: Check for the four categories of Site Class F requiring site-specific evaluation. If the site corresponds to any of these categories, classify the site as Site Class F and conduct a site-specific evaluation.

Step 2: Check for the existence of a total thickness of soft clay > 10 ft (3 m) where a soft clay layer is defined by: $s_u < 500$ psf (25 kPa), $w \geq 40$ percent, and $PI > 20$. If these criteria are satisfied, classify the site as Site Class E.

Step 3: Categorize the site using one of the following three methods with \bar{v}_s , \bar{N} and \bar{s}_u computed in all cases as specified in Sec. 3.5.1:

- \bar{v}_s for the top 100 ft (30 m) (\bar{v}_s method)
- \bar{N} for the top 100 ft (30 m) (\bar{N} method)
- \bar{N}_{ch} for cohesionless soil layers ($PI < 20$) in the top 100 ft (30 m) and average \bar{s}_u for cohesive soil layers ($PI > 20$) in the top 100 ft (30 m) (\bar{s}_u method)

Table 3.5-1 Site Classification

Site Class	\bar{v}_s	\bar{N} or \bar{N}_{ch}	\bar{s}_u^a
E	< 600 fps (< 180 m/s)	< 15	$< 1,000$ psf (< 50 kPa)
D	600 to 1,200 fps (180 to 360 m/s)	15 to 50	1,000 to 2,000 psf (50 to 100 kPa)
C	$> 1,200$ to 2,500 fps (360 to 760 m/s)	> 50	$> 2,000$ (> 100 kPa)

^a If the \bar{s}_u method is used and the \bar{N}_{ch} and \bar{s}_u criteria differ, select the category with the softer soils (for example, use Site Class E instead of D).

Assignment of Site Class B shall be based on the shear wave velocity for rock. For competent rock with moderate fracturing and weathering, estimation of this shear wave velocity shall be permitted. For more highly fractured and weathered rock, the shear wave velocity shall be directly measured or the site shall be assigned to Site Class C.

Assignment of Site Class A shall be supported by either shear wave velocity measurements on site or shear wave velocity measurements on profiles of the same rock type in the same formation with an equal or greater degree of weathering and fracturing. Where hard rock conditions are known to be continuous to a depth of 100 ft (30 m), surficial shear wave velocity measurements may be extrapolated to assess \bar{v}_s .

Site Classes A and B shall not be used where there is more than 10 ft (3 m) of soil between the rock surface and the bottom of the spread footing or mat foundation.

This page is intentionally left blank.

Chapter 4

STRUCTURAL DESIGN CRITERIA

4.1 GENERAL

4.1.1 Scope. The structural design criteria to be used in the design of buildings and other structures and their components shall be as prescribed in this chapter. As an alternative, the seismic analysis and design procedures of Alternative Simplified Chapter 4 shall be permitted to be used in lieu of the requirements of this chapter, subject to all of the limitations contained in the Alternate Chapter 4.

4.1.2 References. The following reference documents shall be used as indicated in this chapter.

- ACI 318 *Building Code Requirements for Structural Concrete*, American Concrete Institute, 1999, excluding Appendix A.
- AISC ASD *Allowable Stress Design and Plastic Design Specification for Structural Steel Buildings*, American Institute of Steel Construction, 1989.
- AISC LRFD *Load and Resistance Factor Design Specification for Structural Steel Buildings*, American Institute of Steel Construction, 1993.
- AISC Seismic *Seismic Provisions for Structural Steel Buildings, Part I*, American Institute of Steel Construction, 1997, including Supplement No. 2 (2000).
- AISI *Specification for the Design of Cold-formed Steel Structural Members*, American Iron and Steel Institute, 1996, including Supplement No. 1 (2000).
- ASCE 7 *Minimum Design Loads for Buildings and Other Structures*, American Society of Civil Engineers, 1998.

4.1.3 Definitions

Base: The level at which the horizontal seismic ground motions are considered to be imparted to the structure.

Base shear: Total design lateral force at the base.

Bearing wall: An exterior or interior wall providing support for vertical loads.

Bearing wall system: A structural system with bearing walls providing support for all or major portions of the vertical loads. Shear walls or braced frames provide seismic-force resistance.

Braced frame: An essentially vertical truss that is provided to resist the effects of horizontal loads.

Building: Any structure whose use could include shelter of human occupants.

Building frame system: A structural system with an essentially complete space frame system providing support for vertical loads. Seismic-force resistance is provided by shear walls or braced frames.

Cantilevered column system: A seismic-force-resisting system in which lateral forces are resisted entirely by columns acting as cantilevers from the foundation.

Collector: See drag strut.

Component: See Sec. 1.1.4.

Concentrically braced frame (CBF): A braced frame in which the members are subjected primarily to axial forces.

Dead load: The gravity load due to the weight of all permanent structural and nonstructural components such as walls, floors, roofs, and the operating weight of fixed service equipment.

Design strength: Nominal strength multiplied by the strength reduction factor, ϕ .

Diaphragm: A roof, floor, or other membrane system acting to transfer lateral forces to the vertical resisting elements. Diaphragms are classified as either flexible or rigid according to the requirements of Sec. 4.3.2.1 and 12.4.1.1.

Drag strut: A diaphragm or shear wall boundary element parallel to the applied load that collects and transfers diaphragm shear forces to the vertical force-resisting elements or distributes forces within the diaphragm or shear wall.

Dual frame system: A structural system with an essentially complete space frame system providing support for vertical loads. Seismic force resistance is provided by a moment resisting frame and shear walls or braced frames as prescribed in Sec. 4.3.1.1

Eccentrically braced frame (EBF): A braced frame in which at least one end of each diagonal connects to a beam a short distance from a beam-column joint or from another diagonal.

Height: Distance measured from the base of the structure as defined in sec. 4.1.3 to the roof level.

Intermediate moment frame: A moment frame of reinforced concrete satisfying the detailing requirements of ACI 318, of structural steel satisfying the detailing requirements of AISC Seismic, or of composite construction satisfying the requirements of AISC Seismic.

Inverted pendulum-type structure: Structures that have a large portion of their mass concentrated near the top and, thus, have essentially one degree of freedom in horizontal translation. The structures are usually T-shaped with a single column supporting the beams or framing at the top.

Joint: See Sec. 9.1.3.

Live load: The load superimposed by the use and/or occupancy of the structure not including the wind load, earthquake load, or dead load.

Moment frame: A frame provided with restrained connections between the beams and columns to permit the frame to resist lateral forces through the flexural rigidity and strength of its members.

Nominal strength: Strength of a member or cross section calculated in accordance with the requirements and assumptions of the strength design methods of these *Provisions* (or the reference standards) before application of any strength reduction factors.

Ordinary concentrically braced frame (OCBF): A steel concentrically braced frame in which members and connections are designed in accordance with the provisions of Ref. 8-3 without modification.

Ordinary moment frame: A moment frame of reinforced concrete conforming to the requirements of ACI 318 exclusive of Chapter 21, of structural steel satisfying the detailing requirements of AISC Seismic, or of composite construction satisfying the requirements of AISC Seismic.

Plain concrete: See Sec. 9.1.3.

Reinforced concrete: See Sec. 9.1.3.

Required strength: Strength of a member, cross section, or connection required to resist factored loads or related internal moments and forces in such combinations as stipulated by these *Provisions*.

Seismic Design Category: See Sec. 1.1.4.

Seismic-force-resisting system: See Sec. 1.1.4.

Seismic forces: See Sec. 1.1.4.

Seismic Use Group: See Sec. 1.1.4.

Shear panel: A floor, roof, or wall component sheathed to act as a shear wall or diaphragm.

Shear wall: A wall designed to resist lateral forces parallel to the plane of the wall.

Space frame system: A structural system composed of interconnected members, other than bearing walls, that is capable of supporting vertical loads and that also may provide resistance to shear.

Special concentrically braced frame (SCBF): A steel or composite steel and concrete concentrically braced frame in which members and connections are designed for ductile behavior

Special moment frame: A moment frame of reinforced concrete satisfying the detailing requirements of ACI 318, of structural steel satisfying the detailing requirements of AISC Seismic, of composite construction satisfying the requirements of AISC Seismic, or of masonry construction satisfying the requirements of Sec. 11.7.

Special Shear plate steel wall: A shear wall composed of steel webs and structural steel boundary elements.

Story: The portion of a structure between the tops of two successive finished floor surfaces or, for the topmost story, between the finished floor surface and the top of the roof structural element.

Story drift ratio: The story drift, as determined in Sec. 5.2.6, 5.3.5, or 5.4.3, divided by the story height.

Structure: See Sec. 1.1.4.

Subdiaphragm: A portion of a diaphragm used to transfer wall anchorage forces to the diaphragm cross ties.

Wall: A component that is used to enclose or divide space and is inclined at an angle of at least 60 degrees from the horizontal plane.

4.1.4 Notation

C_d The deflection amplification factor as given in Table 4.3-1.

D The effect of dead load.

E The effect of horizontal and vertical earthquake-induced forces.

F_i The portion of the seismic base shear, V , induced at Level i .

F_p The seismic design force applicable to a particular structural component.

F_{px} The diaphragm design force at Level x .

h_{sx} The story height below Level $x = h_x - h_{x-i}$.

I See Sec. 1.1.5.

Level i The building level referred to by the subscript i ; $i = 1$ designates the first level above the base.

Level n The level that is uppermost in the main portion of the of the building.

Q_E The effect of horizontal seismic forces.

R The response modification coefficient as given in Table 4.3-1.

S_{DI} See Sec. 3.1.4.

S_{DS} See Sec. 3.1.4.

T	The period of the fundamental mode of vibration of the structure in the direction of interest as determined in Sec. 5.2.2.
V_x	See Sec. 5.1.3.
W_c	Weight of wall.
W_p	Weight of structural component.
w_i	The portion of the seismic weight, W , located at or assigned to Level i .
w_{px}	The weight tributary to the diaphragm at Level x . Level x See Sec. 1.1.5.
Δ	The design story drift as determined in Sec. 5.2.6, 5.3.5, or 5.4.3.
Δ_a	The allowable story drift as specified in Sec. 4.5.1.
δ_x	The deflection of Level x at the center of the mass at and above Level x .
ρ	The redundancy factor as defined in Sec. 4.3.3.
Ω_0	Overstrength factor as given in Table 4.3-1.

4.2 GENERAL REQUIREMENTS

4.2.1 Design basis. The structure shall include complete lateral and vertical-force-resisting systems capable of providing adequate strength, stiffness, and energy dissipation capacity to withstand the design ground motions within the prescribed limits of deformation and strength demand. The design ground motions shall be assumed to occur along any direction of the structure. The adequacy of the structural systems shall be demonstrated through construction of a mathematical model and evaluation of this model for the effects of the design ground motions. This evaluation shall be based on analysis in which design seismic forces are distributed and applied throughout the height of the structure in accordance with Sec. 4.4. The corresponding structural deformations and internal forces in all members of the structure shall be determined and evaluated against acceptance criteria contained in these *Provisions*. Approved alternative procedures based on general principles of engineering mechanics and dynamics are permitted to be used to establish the seismic forces and their distribution. If an alternative procedure is used, the corresponding internal forces and deformations in the members shall be determined using a model consistent with the procedure adopted.

Individual members shall be provided with adequate strength at all sections to resist the shears, axial forces, and moments determined in accordance with these *Provisions*, and connections shall develop the strength of the connected members or the forces indicated above. The deformation of the structure shall not exceed the prescribed limits.

A continuous load path, or paths, with adequate strength and stiffness shall be provided to transfer all forces from the point of application to the final point of resistance. The foundation shall be designed to accommodate the forces developed or the movements imparted to the structure by the design ground motions. In the determination of the foundation design criteria, special recognition shall be given to the dynamic nature of the forces, the expected ground motions, and the design basis for strength and energy dissipation capacity of the structure.

The design of a structure shall consider the potentially adverse effect that the failure of a single member, connection, or component of the seismic-force-resisting system would have on the stability of the structure.

4.2.2 Combination of load effects. The effects on the structure and its components due to gravity loads and seismic forces shall be combined in accordance with the factored load combinations as presented in ASCE 7 except that the effect of seismic loads, E , shall be as defined in this section.

4.2.2.1 Seismic load effect. The effect of seismic load, E , shall be defined by Eq. 4.2-1 as follows for load combinations in which the effects of gravity loads and seismic loads are additive:

$$E = \rho Q_E + 0.2 S_{DS} D \quad (4.2-1)$$

where:

- E = the effect of horizontal and vertical earthquake-induced forces,
- ρ = the redundancy factor,
- Q_E = the effect of horizontal seismic forces,
- S_{DS} = the design spectral response acceleration parameter at short periods as defined in Sec. 3.3.3, and
- D = the effect of dead load.

The effect of seismic load, E , shall be defined by Eq. 4.2-2 as follows for load combinations in which the effects of gravity counteract seismic load:

$$E = \rho Q_E - 0.2 S_{DS} D \quad (4.2-2)$$

where E , ρ , Q_E , S_{DS} , and D are as defined above.

4.2.2.2 Seismic load effect with overstrength. Where specifically required by these *Provisions*, the design seismic force on components sensitive to the effects of structural overstrength shall be as defined by Eq. 4.2-3 and 4.2-4 for load combinations in which the effects of gravity are respectively additive with or counteractive to the effect of seismic loads:

$$E = \Omega_0 Q_E + 0.2 S_{DS} D \quad (4.2-3)$$

$$E = \Omega_0 Q_E - 0.2 S_{DS} D \quad (4.2-4)$$

where E , Q_E , S_{DS} , and D are as defined above and Ω_0 is the system overstrength factor as given in Table 4.3-1.

The term $\Omega_0 Q_E$ calculated in accordance with Eq. 4.2-3 and 4.2-4 need not exceed the maximum force that can develop in the element as determined by a rational, plastic mechanism analysis or nonlinear response analysis utilizing realistic expected values of material strengths.

4.3 SEISMIC-FORCE-RESISTING SYSTEM

4.3.1 Selection and limitations. The basic lateral and vertical seismic-force-resisting system shall conform to one of the types indicated in Table 4.3-1 subject to the system limitations and height limits, based on Seismic Design Category, indicated in the table. Each type is subdivided based on types of vertical elements used to resist lateral seismic forces. The appropriate values of R , Ω_0 , and C_d indicated in Table 4.3-1 shall be used in determining the base shear, element design forces, and design story drift as indicated in these *Provisions*.

Seismic-force-resisting systems that are not contained in Table 4.3-1 shall be permitted if analytical and test data are submitted that establish the dynamic characteristics and demonstrate the lateral force resistance and energy dissipation capacity to be equivalent to the structural systems listed in Table 4.3-1 for equivalent values of R , Ω_0 , and C_d .

Additional limitations and framing requirements are indicated in this chapter and in elsewhere in these *Provisions* for structures assigned to the various Seismic Design Categories.

Table 4.3-1 Design Coefficients and Factors for Basic Seismic-Force-Resisting Systems

Basic Seismic-Force-Resisting System	Detailing Reference Section	R^a	Ω_0^b	C_d^c	System Limitations and Height Limits (ft) by Seismic Design Category ^d					
					B	C	D^e	E^e	F^f	
Bearing Wall Systems										
Special reinforced concrete shear walls	9.2.1.6	5	2½	5	NL	NL	160	160	100	
Ordinary reinforced concrete shear walls	9.2.1.4	4	2½	4	NL	NL	NP	NP	NP	
Detailed plain concrete shear walls	9.2.1.2	2	2½	2	NL	NP	NP	NP	NP	
Ordinary plain concrete shear walls	9.2.1.1	1½	2½	1½	NL	NP	NP	NP	NP	
Intermediate precast shear walls	9.2.1.5	4	2½	4	NL	NL	40 ^k	40 ^k	40 ^k	
Ordinary precast shear walls	9.2.1.3	3	2½	3	NL	NP	NP	NP	NP	
Special reinforced masonry shear walls	11.5.6.3	3½	2½	3½	NL	NL	160	160	100	
Intermediate reinforced masonry shear walls	11.5.6.2	2½	2½	2¼	NL	NL	NP	NP	NP	
Ordinary reinforced masonry shear walls	11.5.6.1	2	2½	1¾	NL	NP	NP	NP	NP	
Detailed plain masonry shear walls	11.4.4.2	2	2½	1¾	NL	NP	NP	NP	NP	
Ordinary plain masonry shear walls	11.4.4.1	1½	2½	1¼	NL	NP	NP	NP	NP	
Prestressed masonry shear walls	11.9	1½	2½	1¾	NL	NP	NP	NP	NP	
Light-frame walls with shear panels	8.4, 12.3.3, 12.4	6½	3	4	NL	NL	65	65	65	
Light-frame walls with diagonal braces	8.4.2	4	2	3½	NL	NL	65	65	65	
Building Frame Systems										
Steel eccentrically braced frames with moment-resisting connections at columns away from links	AISC Seismic, Part I, Sec. 15	8	2	4	NL	NL	160	160	100	

Basic Seismic-Force-Resisting System	Detailing Reference Section	R^a	Ω_0^b	C_d^c	System Limitations and Height Limits (ft) by Seismic Design Category ^d				
					B	C	D^e	E^e	F^f
Steel eccentrically braced frames with non-moment-resisting connections at columns away from links	AISC Seismic, Part I, Sec. 15	7	2	4	NL	NL	160	160	100
Buckling-Restrained Braced Frames, non-moment-resisting beam-column connections		7	2	5½	NL	NL	160	160	100
Buckling-Restrained Braced Frames, moment-resisting Beam-column connections		8	2½	5	NL	NL	160	160	100
Special steel concentrically braced frames	AISC Seismic, Part I, Sec. 13	6	2	5	NL	NL	160	160	100
Ordinary steel concentrically braced frames	AISC Seismic, Part I, Sec. 14	5	2	4½	NL	NL	35 ^g	35 ^g	NP ^g
Special reinforced concrete shear walls	9.2.1.6	6	2½	5	NL	NL	160	160	100
Ordinary reinforced concrete shear walls	9.2.1.4	5	2½	4½	NL	NL	NP	NP	NP
Detailed plain concrete shear walls	9.2.1.2	2½	2½	2½	NL	NP	NP	NP	NP
Ordinary plain concrete shear walls	9.2.1.1	1½	2½	1½	NL	NP	NP	NP	NP
Intermediate precast shear walls	9.2.1.5	5	2½	4½	NL	NL	40 ^k	40 ^k	40 ^k
Ordinary precast shear walls	9.2.1.3	4	2½	4	NL	NP	NP	NP	NP
Composite eccentrically braced frames	AISC Seismic, Part II, Sec. 14	8	2½	4	NL	NL	160	160	100
Composite concentrically braced frames	AISC Seismic, Part II, Sec. 12	5	2	4½	NL	NL	160	160	100
Ordinary composite braced frames	AISC Seismic, Part II, Sec. 13	3	2	3	NL	NL	NP	NP	NP
Composite steel plate shear walls	AISC Seismic, Part II, Sec. 17	6½	2½	5½	NL	NL	160	160	100
Special steel plate shear walls		7	2	6	NL	NL	160	160	100
Special composite reinforced concrete shear walls with steel elements	AISC Seismic, Part II, Sec. 16	6	2½	5	NL	NL	160	160	100
Ordinary composite reinforced concrete shear walls with steel elements	AISC Seismic, Part II, Sec. 15	5	2½	4½	NL	NL	NP	NP	NP

Basic Seismic-Force-Resisting System	Detailing Reference Section	R^a	Ω_0^b	C_d^c	System Limitations and Height Limits (ft) by Seismic Design Category ^d					
					B	C	D ^e	E ^e	F ^f	
Special reinforced masonry shear walls	11.5.6.3	4½	2½	4	NL	NL	160	160	100	
Intermediate reinforced masonry shear walls	11.5.6.2	3	2½	2½	NL	NL	NP	NP	NP	
Ordinary reinforced masonry shear walls	11.5.6.1	2	2½	2	NL	NP	NP	NP	NP	
Detailed plain masonry shear walls	11.4.4.2	2	2½	2	NL	NP	Np	NP	NP	
Ordinary plain masonry shear walls	11.4.4.1	1½	2½	1¼	NL	NP	NP	NP	NP	
Prestressed masonry shear walls	11.9	1½	2½	1¾	NL	NP	NP	NP	NP	
Light-frame walls with shear panels	8.4, 12.3.3, 12.4	7	2½	4½	NL	NL	160	160	160	
Moment Resisting Frame Systems										
Special steel moment frames	AISC Seismic, Part I, Sec. 9	8	3	5½	NL	NL	NL	NL	NL	
Special steel truss moment frames	AISC Seismic, Part I, Sec. 12	7	3	5½	NL	NL	160	100	NP	
Intermediate steel moment frames	AISC Seismic, Part I, Sec. 10	4½	3	4	NL	NL	35 ^h	NP ^h	NP ⁱ	
Ordinary steel moment frames	AISC Seismic, Part I, Sec. 11	3½	3	3	NL	NL	NP ^h	NP ^h	NP ⁱ	
Special reinforced concrete moment frames	9.2.2.2 & ACI 318, Chapter 21	8	3	5½	NL	NL	NL	NL	NL	
Intermediate reinforced concrete moment frames	9.2.2.3 & ACI 318, Chapter 21	5	3	4½	NL	NL	NP	NP	NP	
Ordinary reinforced concrete moment frames	9.3.1 & ACI 318, Chapter 21	3	3	2½	NL	NP	NP	NP	NP	
Special composite moment frames	AISC Seismic, Part II, Sec. 9	8	3	5½	NL	NL	NL	NL	NL	
Intermediate composite moment frames	AISC Seismic, Part II, Sec. 10	5	3	4½	NL	NL	NP	NP	NP	
Composite partially restrained moment frames	AISC Seismic, Part II, Sec. 8	6	3	5½	160	160	100	NP	NP	
Ordinary composite moment frames	AISC Seismic, Part II, Sec. 11	3	3	2½	NL	NP	NP	NP	NP	

Basic Seismic-Force-Resisting System	Detailing Reference Section	R^a	Ω_0^b	C_d^c	System Limitations and Height Limits (ft) by Seismic Design Category d				
					B	C	D^e	E^e	F^f
Special masonry moment frames	11.7	5½	3	5	NL	NL	160	160	100
Dual Systems with Special Moment Frames (See Sec. 4.3.1.1.)									
Steel eccentrically braced frames	AISC Seismic, Part I, Sec. 15	8	2½	4	NL	NL	NL	NL	NL
Buckling-Restrained Braced Frame		8	2½	5	NL	NL	NL	NL	NL
Special steel concentrically braced frames	AISC Seismic, Part I, Sec. 13	7	2½	5½	NL	NL	NL	NL	NL
Special reinforced concrete shear walls	9.2.1.4	8	2½	6½	NL	NL	NL	NL	NL
Ordinary reinforced concrete shear walls	9.2.1.3	6	2½	5	NL	NL	NP	NP	NP
Composite eccentrically braced frames	AISC Seismic, Part II, Sec. 14	8	2½	4	NL	NL	NL	NL	NL
Composite concentrically braced frames	AISC Seismic, Part II, Sec. 12	6	2	5	NL	NL	NL	NL	NL
Special steel plate shear walls		8	2½	6½	NL	NL	NL	NL	NL
Composite steel plate shear walls	AISC Seismic, Part II, Sec. 17	7½	2½	6	NL	NL	NL	NL	NL
Special composite reinforced concrete shear walls with steel elements	AISC Seismic, Part II, Sec. 16	7	2½	6	NL	NL	NL	NL	NL
Ordinary composite reinforced concrete shear walls with steel elements	AISC Seismic, Part II, Sec. 15	6	2½	5	NL	NL	NP	NP	NP
Special reinforced masonry shear walls	11.5.6.3	5½	3	5	NL	NL	NL	NL	NL
Intermediate reinforced masonry shear walls	11.5.6.2	4	3	3½	NL	NL	NL	NP	NP
Dual Systems with Intermediate Moment Frames (See Sec. 4.3.1.1.)									
Special steel concentrically braced frames j	AISC Seismic, Part I, Sec. 13	6	2½	5	NL	NL	35 h	NP $^h, i$	NP $^h, i$

Basic Seismic-Force-Resisting System	Detailing Reference Section	R^a	Ω_0^b	C_d^c	System Limitations and Height Limits (ft) by Seismic Design Category ^d					
					B	C	D^e	E^e	F^f	
Special reinforced concrete shear walls	9.2.1.4	6½	2½	5	NL	NL	160	100	100	
Ordinary reinforced concrete shear walls	9.2.1.3	5½	2½	4½	NL	NL	NP	NP	NP	
Ordinary reinforced masonry shear walls	11.5.6.1	3	3	2½	NL	160	NP	NP	NP	
Intermediate reinforced masonry shear walls	11.5.6.2	3½	3	3	NL	NL	160	NP	NP	
Composite concentrically braced frames	AISC Seismic, Part II, Sec. 12	5½	2½	4½	NL	NL	160	100	NP	
Ordinary composite braced frames	AISC Seismic, Part II, Sec. 13	3½	2½	3	NL	NL	NP	NP	NP	
Ordinary composite reinforced concrete shear walls with steel elements	AISC Seismic, Part II, Sec. 15	5½	2½	4½	NL	NL	NP	NP	NP	
Inverted Pendulum Systems and Cantilevered Column Systems										
Special steel moment frames	AISC Seismic, Part I, Sec. 9	2½	2	2½	NL	NL	NL	NL	NL	
Ordinary steel moment frames	AISC Seismic, Part I, Sec. 11	1¼	2	1¼	NL	NL	NP	NP	NP	
Special reinforced concrete moment frames	ACI 318, Chapter 21	2½	2	2½	NL	NL	NL	NL	NL	
Steel Systems Not Specifically Detailed for Seismic Resistance	AISC ASD, AISC LRFD, AISI	3	3	3	NL	NL	NP	NP	NP	

^a Response modification coefficient, R , for use throughout these Provisions.

^b The tabulated value of Ω_0 may be reduced by subtracting ½ for structures with flexible diaphragms, but shall not be taken as less than 2.0 for any structure.

^c Deflection amplification factor, C_d , for use throughout these Provisions.

^d NL = not limited and NP = not permitted. If using metric units, 100 ft approximately equals 30 m and 160 ft approximately equals 50 m.

^e See Sec. 4.3.1.4.1 for a description of building systems limited to buildings with a height of 240 ft (70 m) or less.

^f See Sec. 4.3.1.6 for building systems limited to buildings with a height of 160 ft (50 m) or less.

^g Steel ordinary braced frames are permitted in single story buildings up to a height of 65 ft when the dead load of the roof does not exceed 20 psf and in penthouse structures.

^h See limitations in Section Nos. 4.3.1.4.4, 4.3.1.4.5, and 4.3.1.5.2.

ⁱ See limitations in Section Nos. 4.3.1.6.1 and 4.3.1.6.2.

^j Ordinary moment frame is permitted to be used in lieu of intermediate moment frame in Seismic Design Categories B and C.

^k For intermediate precast shear wall buildings the dead load of the roof system shall not exceed 20 psf.

4.3.1.1 Dual system. For a dual system, the moment frame shall be capable of resisting at least 25 percent of the design forces. The total seismic force resistance is to be provided by the combination of the moment frame and the shear walls or braced frames in proportion to their rigidities.

4.3.1.2 Combinations of framing systems. Different seismic-force-resisting systems are permitted along the two orthogonal axes of the structure. Combinations of seismic-force-resisting systems shall comply with the requirements of this section.

4.3.1.2.1 R and Ω_0 factors. In any given direction, the value of R at any story shall not exceed the lowest value of R in the same direction above that story excluding penthouses. For other than dual systems, where a combination of different structural systems is utilized to resist lateral forces in the same direction, the value of R used in that direction shall not be greater than the least value of any of the systems utilized in the same direction. If a system, other than a dual system, with a value of R less than 5 is used as part of the seismic-force-resisting system in any direction of the structure, the lowest such value shall be used for the entire structure. The system overstrength factor, Ω_0 , in the direction under consideration at any story shall not be less than the largest value of this factor for the seismic-force-resisting system in the same direction considered above that story.

Exceptions: The requirements of this section need not be applied where one of the following conditions is satisfied:

1. Supported structural systems with a weight equal to or less than 10 percent of the weight of the structure.
2. Detached one- and two-family dwellings of light-frame construction.

4.3.1.2.2 Detailing of common components. The detailing requirements for the higher response modification coefficient, R , shall be used for structural components common to systems having different response modification coefficients.

4.3.1.3 Seismic Design Categories B and C. The structural framing system for structures assigned to Seismic Design Category B or C shall comply with the system limitations and building height limits in Table 4.3-1.

4.3.1.4 Seismic Design Category D. The structural framing system for structures assigned to Seismic Design Category D shall comply with Sec. 4.3.1.3 and the additional requirements of this section.

4.3.1.4.1 Building height limits. The height limits in Table 4.3-1 are permitted to be increased to 240 ft (70 m) in buildings that have steel braced frames or concrete cast-in-place shear walls if such buildings are configured such that the braced frames or shear walls arranged in any one plane conform to the following:

1. The braced frames or cast-in-place special reinforced concrete shear walls in any one plane shall resist no more than 60 percent of the total seismic forces in each direction, neglecting torsional effects, and
2. The seismic force in any braced frame or shear wall resulting from torsional effects shall not exceed 20 percent of the total seismic force in that braced frame or shear wall.

4.3.1.4.2 Interaction effects. Moment resisting frames that are enclosed or adjoined by more rigid elements not considered to be part of the seismic-force-resisting system shall be designed so that the action or failure of those elements will not impair the vertical load and seismic force resisting capability of the frame. The design shall consider and provide for the effect of these rigid elements on the structural system at structure deformations corresponding to the design story drift, Δ , as determined in Sec. 5.2.6.1. In addition, the effects of these elements shall be considered where determining whether a structure has one or more of the irregularities defined in Sec. 4.3.2.

4.3.1.4.3 Special moment frames. A special moment frame that is used but not required by Table 4.3-1 is permitted to be discontinued and supported by a more rigid system with a lower response

modification coefficient, R , provided the requirements of Sec. 4.6.1.6 and 4.6.3.2 are met. Where a special moment frame is required by Table 4.3-1 as part of a dual system, the frame shall be continuous to the foundation.

For structures with seismic-force-resisting systems in any direction comprised solely of special moment frames, the seismic-force-resisting system shall be configured such that the value of ρ is 1.0

4.3.1.4.4 Single Story Steel Ordinary and Intermediate Moment Frame Limitations.

Single story steel OMF and IMF are permitted up to a height of 65ft. (19.8 m) where the dead load supported by and tributary to the roof does not exceed 20 psf. In addition the dead loads, tributary to the moment frame, of the exterior wall more than 35 ft. (10.8 m) above the base shall not exceed 20 psf.

4.3.1.4.5 Other Steel Ordinary and Intermediate Moment Frame Limitations. Steel OMF not meeting the limitations in Sec. 4.3.1.4.4 are permitted within light frame construction up to a height of 35 ft. (10.8m) where neither the roof nor the floor dead load supported by and tributary to the moment frames exceeds 35 psf. In addition the dead load of the exterior walls tributary to the moment frame shall not exceed 20 psf.

Steel IMF not meeting the limitations in Sec. 4.3.1.4.4 are permitted to a height of 35ft. (10.8m)

4.3.1.5 Seismic Design Category E. The structural framing system for a structure assigned to Seismic Design Category E shall comply with Sec. 4.3.1.4 and the additional requirements of this section.

4.3.1.5.1 Plan or vertical irregularities. Structures having plan irregularity Type 1b of Table 4.3-2 or vertical irregularities Type 1b or 5 of Table 4.3-3 shall not be permitted.

4.3.1.5.2 Steel Intermediate Moment Frame Limitations.

Steel IMF not meeting the limitations in Section 4.3.1.4.4 are permitted to a height of 35 ft. (10.8 m) providing neither the roof nor the floor dead load supported by and tributary to the moment frames exceeds 35 psf. In addition the dead load of the exterior walls tributary to the moment frame shall not exceed 20 psf.

4.3.1.6 Seismic Design Category F. The structural framing system for a structure assigned to Seismic Design Category F shall comply with Sec. 4.3.1.5 and the additional requirements of this section. The height limits given in Sec. 4.3.1.4.1 shall be reduced from 240 ft to 160 ft (70 to 50 m).

4.3.1.6.1 Single Story Steel Ordinary and Intermediate Moment Frame Limitations.

Single story steel OMF and IMF are permitted up to a height of 65' where the dead load supported by and tributary to the roof does not exceed 20 psf. In addition the dead load of the exterior walls tributary to the moment frame shall not exceed 20 psf.

4.3.1.6.2 Other Steel Intermediate Moment Frame Limitations.

Steel IMF not meeting the limitations in Sec. 4.3.1.4.4 are permitted in light frame construction to a height of 35 ft. (10.8 m) providing neither the roof nor the floor dead load supported by and tributary to the moment frames exceeds 35 psf. In addition the dead load of the exterior walls tributary to the moment frame shall not exceed 20 psf.

4.3.2 Configuration. Diaphragm behavior shall be classified as indicated in this section. Structures shall be classified as regular or irregular, based on the plan and vertical configuration, in accordance with this section.

4.3.2.1 Diaphragm flexibility. A diaphragm shall be considered flexible for determining distribution of horizontal forces when the computed maximum in-plane deflection of the diaphragm itself under lateral load is more than two times the average deflection of adjoining vertical elements of the lateral force-resisting system of the associated story under equivalent tributary lateral load. The loadings used for this calculation shall be those prescribed by Sec. 5.2.

Exception: Diaphragms constructed of untopped steel decking, wood structural panels, or similar panelized construction shall be considered flexible in structures having concrete or masonry shear walls.

4.3.2.2 Plan irregularity. Structures having one or more of the features listed in Table 4.3-2 shall be designated as having plan structural irregularity and shall comply with the requirements in the sections referenced in Table 4.3-2.

4.3.2.3 Vertical irregularity. Structures having one or more of the features listed in Table 4.3-3 shall be designated as having vertical irregularity and shall comply with the requirements in the sections referenced in Table 4.3-3.

Exceptions:

1. Structural irregularities of Types 1a, 1b, or 2 in Table 4.3-3 do not apply where no story drift ratio under design lateral load is greater than 130 percent of the story drift ratio of the next story above. Torsional effects need not be considered in the calculation of story drifts for the purpose of this determination. The story drift ratio relationship for the top 2 stories of the structure are not required to be evaluated.
2. Irregularity Types 1a, 1b, and 2 of Table 4.3-3 are not required to be considered for 1-story structures or for 2-story structures assigned to Seismic Design Category B, C, or D.

Table 4.3-2 Plan Structural Irregularities

Irregularity Type and Description		Reference Section	Seismic Design Category Application
1a	Torsional Irregularity—to be considered when diaphragms are not flexible Torsional irregularity shall be considered to exist when the maximum story drift, computed including accidental torsion, at one end of the structure transverse to an axis is more than 1.2 times the average of the story drifts at the two ends of the structure.	4.4.1	D, E, and F
		4.6.3.2	D, E, and F
		5.2.4.3 and 5.2.6.1	C, D, E, and F
1b	Extreme Torsional Irregularity—to be considered when diaphragms are not flexible Extreme torsional irregularity shall be considered to exist when the maximum story drift, computed including accidental torsion, at one end of the structure transverse to an axis is more than 1.4 times the average of the story drifts at the two ends of the structure.	4.3.1.5.1	E and F
		4.4.1	D
		4.6.3.2	D
2	Re-entrant Corners Plan configurations of a structure and its lateral force-resisting system contain re-entrant corners, where both projections of the structure beyond a re-entrant corner are greater than 15 percent of the plan dimension of the structure in the given direction.	5.2.4.3 and 5.2.6.1	C, D, E, and F
		4.6.3.2	D, E, and F
3	Diaphragm Discontinuity Diaphragms with abrupt discontinuities or variations in stiffness, including those having cutout or open areas greater than 50 percent of the gross enclosed diaphragm area, or changes in effective diaphragm stiffness of more than 50 percent from one story to the next.	4.6.3.2	D, E, and F
4	Out-of-Plane Offsets Discontinuities in a lateral force resistance path, such as out-of-plane offsets of the vertical elements.	4.6.1.7	B, C, D, E, and F
		4.6.3.2	D, E, and F
5	Nonparallel Systems The vertical lateral force-resisting elements are not parallel to or symmetric about the major orthogonal axes of the seismic-force-resisting system.	4.4.2.2	C, D, E, and F

Table 4.3-3 Vertical Structural Irregularities

Irregularity Type and Description		Reference Section	Seismic Design Category Application
1a	Stiffness Irregularity—Soft Story A soft story is one in which the lateral stiffness is less than 70 percent of that in the story above or less than 80 percent of the average stiffness of the three stories above.	4.4.1	D, E, and F
1b	Stiffness Irregularity—Extreme Soft Story An extreme soft story is one in which the lateral stiffness is less than 60 percent of that in the story above or less than 70 percent of the average stiffness of the three stories above.	4.3.1.5.1 4.4.1	E and F D
2	Weight (Mass) Irregularity Mass irregularity shall be considered to exist where the effective mass of any story is more than 150 percent of the effective mass of an adjacent story. A roof that is lighter than the floor below need not be considered.	4.4.1	D, E, and F
3	Vertical Geometric Irregularity Vertical geometric irregularity shall be considered to exist where the horizontal dimension of the lateral force-resisting system in any story is more than 130 percent of that in an adjacent story.	4.4.1	D, E, and F
4	In-Plane Discontinuity in Vertical Lateral Force Resisting Elements An in-plane offset of the lateral force-resisting elements greater than the length of those elements or a reduction in stiffness of the resisting element in the story below.	4.6.1.7 4.6.3.2	B, C, D, E, and F D, E, and F
5	Discontinuity in Capacity—Weak Story A weak story is one in which the story lateral strength is less than 80 percent of that in the story above. The story strength is the total strength of all seismic-resisting elements sharing the story shear for the direction under consideration.	4.3.1.5.1 4.6.1.6	E and F B, C, and D

4.3.3 Redundancy. A redundancy factor, ρ , shall be assigned to the seismic force-resisting system in each of two orthogonal directions for all structures in accordance with this section, based on the extent of structural redundancy inherent in the seismic-force-resisting system.

4.3.3.1 Seismic Design Categories B, and C. For structures assigned to Seismic Design Category B or C, the value of ρ may be taken as 1.0.

4.3.3.2 Seismic Design Categories D, E, and F. For structures assigned to Seismic Design Category D, E, or F, ρ shall be permitted to be taken as 1.0, provided that at each story resisting more than 35 percent of the base shear in the direction of interest the seismic-force-resisting system meets the following redundancy requirements:

1. Systems with braced frames: Removal of an individual brace, or connection thereto, would not result in more than a 33 percent reduction in story strength, nor create an extreme torsional irregularity (plan structural irregularity Type 1b).
2. Systems with moment frames: Loss of moment resistance at the beam-to-column connections at both ends of a single beam would not result in more than a 33 percent reduction in story strength, nor create an extreme torsional irregularity (plan structural irregularity Type 1b).
3. Systems with shear walls or wall piers: Removal of a shear wall or wall pier with a height-to-length-ratio greater than 1.0 within any story, or collector connections thereto, would not result in more than a 33 percent reduction in story strength, nor create an extreme torsional irregularity (plan structural irregularity Type 1b).
4. All other systems: No requirements.

For structures not meeting items 1,2,3, and 4 above permitting ρ equal to 1.0, ρ shall be taken as 1.3.

Exception: The structure shall be permitted to be designed using a ρ taken as 1.0, provided that at each story that resists more than 35 percent of the base shear the seismic force-resisting system is regular in plan with at least two bays of primary seismic force-resisting elements located at the perimeter framing on each side of the structure in each orthogonal direction. The number of bays for a shear wall shall be calculated as the length of wall divided by the story height.

4.4 STRUCTURAL ANALYSIS

A structural analysis in accordance with the requirements of this section shall be made for all structures. All members of the structure's seismic-force-resisting system and their connections shall have adequate strength to resist the forces, Q_E , predicted by the analysis, in combination with other loads as required by Sec. 4.2.2.

4.4.1 Procedure selection. The structural analysis required by Sec. 4.4 shall consist of one of the types permitted in Table 4.4-1, based on the assigned Seismic Design Category and the structural characteristics (seismic-force-resisting system, fundamental period of vibration, and configuration). With the approval of the authority having jurisdiction, use of an alternative, generally accepted procedure shall be permitted.

Table 4.4-1 Analysis Procedures

Seismic Design Category	Structural Characteristics	Equivalent Lateral Force Procedure, Sec. 5.2	Response Spectrum Procedure, Sec. 5.3	Linear Response History Procedure, Sec. 5.4	Nonlinear Response History Procedure, Sec. 5.5
B, C	Regular or irregular	P	P	P	P
D, E, F	All structures of light-frame construction; and structures with $T < 3.5T_s$ that are regular or have only plan irregularities Type 2, 3, 4, or 5 of Table 4.3-2 or vertical irregularities Type 4 or 5 of Table 4.3-3	P	P	P	P
	All other structures	NP	P	P	P
P indicates permitted; NP indicates not permitted.					

4.4.2 Application of loading. The directions of application of seismic forces used in the design shall be those that will produce the most critical load effects. The procedures indicated in this section for various Seismic Design Categories shall be deemed to satisfy this requirement.

4.4.2.1 Seismic Design Category B. For structures assigned to Seismic Design Category B, the design seismic forces are permitted to be applied separately in each of two orthogonal directions and orthogonal interaction effects may be neglected.

4.4.2.2 Seismic Design Category C. Loading applied to structures assigned to Seismic Design Category C shall, as a minimum, conform to the requirements of Sec. 4.4.2.1 and the requirements of this section. Structures that have plan irregularity Type 5 in Table 4.3-2 shall be analyzed for seismic forces using a three-dimensional representation and either of the following procedures:

1. The structure shall be analyzed using the equivalent lateral force procedure of Sec. 5.2, the response spectrum procedure of Sec. 5.3, or the linear response history procedure of Sec. 5.4 as permitted under Sec. 4.4.1 with the loading applied independently in any two orthogonal directions and the most critical load effect due to direction of application of seismic forces on the structure may be assumed to be satisfied if components and their foundations are designed for the following combination of prescribed loads: 100 percent of the forces for one direction plus 30 percent of the forces for the perpendicular direction; the combination requiring the maximum component strength shall be used.
2. The structure shall be analyzed using the linear response history procedure of Sec. 5.4 or the nonlinear response history procedure of Sec. 5.5 as permitted by Sec. 4.4.1 with simultaneous application of ground motion in each of two orthogonal directions.

4.4.2.3 Seismic Design Categories D, E, and F. Structures assigned to Seismic Design Category D, E, or F shall be analyzed for seismic forces using a three-dimensional representation and either of the procedures described in Sec. 4.4.2.2. Two dimensional analysis shall be permitted where diaphragms are flexible and the structure does not have plan irregularity Type 5 of Table 4.3-2.

4.5 DEFORMATION REQUIREMENTS

4.5.1 Deflection and drift limits. The design story drift, Δ , as determined in Sec. 5.2.6, 5.3.5, or 5.4.3, shall not exceed the allowable story drift, Δ_a , as obtained from Table 4.5-1 for any story. For structures with significant torsional deflections, the maximum drift shall include torsional effects. All portions of the structure shall be designed and constructed to act as an integral unit in resisting seismic forces unless separated structurally by a distance sufficient to avoid damaging contact under total deflection, δ_x , as determined in Sec. 5.2.6.1.

Table 4.5-1 Allowable Story Drift, Δ_a ^{ab}

Structure	Seismic Use Group		
	I	II	III
Structures, other than those using masonry seismic-force-resisting systems, four stories or less in height with interior walls, partitions, ceilings, and exterior wall systems that have been designed to accommodate the story drifts	$0.025 h_{sx}$ ^c	$0.020 h_{sx}$	$0.015 h_{sx}$
Masonry cantilever shear wall structures ^d	$0.010 h_{sx}$	$0.010 h_{sx}$	$0.010 h_{sx}$
Other masonry shear wall structures	$0.007 h_{sx}$	$0.007 h_{sx}$	$0.007 h_{sx}$
Special masonry moment frames	$0.013 h_{sx}$	$0.013 h_{sx}$	$0.010 h_{sx}$
All other structures	$0.020 h_{sx}$	$0.015 h_{sx}$	$0.010 h_{sx}$

^a h_{sx} is the story height below Level x .
^b For SDC D,E and F, the allowable story drift shall comply with the requirements of Sec.4.5.3.
^c There shall be no drift limit for single-story structures with interior walls, partitions, ceilings, and exterior wall systems that have been designed to accommodate the story drifts.
^d Structures in which the basic structural system consists of masonry shear walls designed as vertical elements cantilevered from their base or foundation support which are so constructed that moment transfer between shear walls (coupling) is negligible.

4.5.2 Seismic Design Categories B and C. The deflection in the plane of the diaphragm, as determined by engineering analysis, shall not exceed the permissible deflection of the attached elements. Permissible deflection shall be a deflection that permits the attached elements to maintain their structural integrity under the individual loading and to continue to support the prescribed loads.

4.5.3 Seismic Design Categories D, E, and F. Structures assigned to Seismic Design Category D, E, or F shall comply with Sec. 4.5.2 and the additional requirements of this section. Every structural component not included as part of the seismic-force-resisting system in the direction under consideration shall be designed to be adequate for the effects of gravity loads in combination with the induced moments and shears resulting from the design story drift, Δ , as determined in accordance with Sec. 5.2.6.1.

Exception: Beams and columns and their connections not designed as part of the seismic-force-resisting system but meeting the detailing requirements for either intermediate moment frames or special moment frames are permitted to be designed to be adequate for the effects of

gravity loads in combination with the induced moments and shears resulting from the deformation of the building under the application of the design seismic forces.

Where determining the moments and shears induced in components that are not included as part of the seismic-force-resisting system in the direction under consideration, the stiffening effects of adjoining rigid structural and nonstructural elements shall be considered and a rational value of member and restraint stiffness shall be used.

For systems with moment frames the design story drift Δ , as determined in Sec. 5.2.6, 5.3.5, or 5.4.3, shall not exceed Δ_a/ρ for any story. ρ shall be calculated per Sec.4.3.3.

4.6 DESIGN AND DETAILING REQUIREMENTS

The design and detailing of the components of the seismic-force-resisting system shall comply with the requirements of this section. Foundation design shall comply with the applicable requirements of Chapter 7. The materials and the systems composed of those materials shall comply with applicable requirements and limitations found elsewhere in these *Provisions*.

4.6.1 Seismic Design Category B. The design and detailing of structures assigned to Seismic Design Category B shall comply with the requirements of this section.

4.6.1.1 Connections. All parts of the structure between separation joints shall be interconnected, and the connections shall be capable of transmitting the seismic force, F_p , induced by the parts being connected. Any smaller portion of the structure shall be tied to the remainder of the structure with elements having a strength of 0.133 times S_{DS} times the weight of the smaller portion or 5 percent of the portion's weight, whichever is greater.

A positive connection for resisting a horizontal force acting parallel to the member shall be provided for each beam, girder, or truss to its support. The connection shall have a minimum strength of 5 percent of the reaction due to dead load and live load.

4.6.1.2 Anchorage of concrete or masonry walls. Concrete or masonry walls shall be connected, using reinforcement or anchors, to the roof and all floors and members that provide lateral support for the wall or that are supported by the wall. The connection shall be capable of resisting a seismic lateral force induced by the wall of 100 pounds per lineal foot (1500 N/m). Walls shall be designed to resist bending between connections where the spacing exceeds 4 ft (1.2 m).

4.6.1.3 Bearing walls. Exterior and interior bearing walls and their anchorage shall be designed for a force equal to 40 percent of S_{DS} times the weight of wall, W_c , normal to the surface, with a minimum force of 10 percent of the weight of the wall. Interconnection of wall elements and connections to supporting framing systems shall have sufficient ductility, rotational capacity, or strength to resist shrinkage, thermal changes, and differential foundation settlement where combined with seismic forces.

4.6.1.4 Openings. Where openings occur in shear walls, diaphragms or other plate-type elements, reinforcement at the edges of the openings shall be designed to transfer the stresses into the structure. The edge reinforcement shall extend into the body of the wall or diaphragm a distance sufficient to develop the force in the reinforcement.

4.6.1.5 Inverted pendulum-type structures. Supporting columns or piers of inverted pendulum-type structures shall be designed for the bending moment calculated at the base determined using the procedures given in Sec. 5.2 and varying uniformly to a moment at the top equal to one-half the calculated bending moment at the base.

4.6.1.6 Discontinuities in vertical system. Structures with vertical irregularity Type 5 as defined in Table 4.3-3, shall not be over the lesser of 2 stories or 30 ft (9 m) in height where the weak story has a calculated strength of less than 65 percent of the strength of the story above.

Exception: The height limit shall not apply where the weak story is capable of resisting a total seismic force equal to 75 percent of the deflection amplification factor, C_d , times the design force prescribed in Sec. 5.2.

4.6.1.7 Columns supporting discontinuous walls or frames. Columns supporting discontinuous walls or frames of structures having plan irregularity Type 4 of Table 4.3-2 or vertical irregularity Type 4 of Table 4.3-3 shall have the design strength to resist the maximum axial force that can develop in accordance with Sec. 4.2.2.2.

4.6.1.8 Collector elements. Collector elements shall be provided and shall be capable of transferring the seismic forces originating in other portions of the structure to the element providing the resistance to those forces.

4.6.1.9 Diaphragms. Floor and roof diaphragms shall be designed to resist the following seismic forces: A minimum force equal to 20 percent of S_{DS} times the weight of the diaphragm and other elements of the structure attached thereto plus the portion of the seismic shear force at that level, V_x , required to be transferred to the components of the vertical seismic-force-resisting system because of offsets or changes in stiffness of the vertical components above and below the diaphragm.

Diaphragms shall provide for both the shear and bending stresses resulting from these forces. Diaphragms shall have ties or struts to distribute the wall anchorage forces into the diaphragm. Diaphragm connections shall be positive, mechanical or welded type connections.

4.6.1.10 Anchorage of nonstructural systems. Where required by Chapter 6, all portions or components of the structure shall be anchored for the seismic force, F_p , prescribed therein.

4.6.2 Seismic Design Category C. Structures assigned to Seismic Design Category C shall comply with the requirements of Sec. 4.6.1 and the requirements of this section.

4.6.2.1 Anchorage of concrete or masonry walls. In addition to the requirements of Sec. 4.6.1.2, concrete or masonry walls shall be anchored in accordance with this section. The anchorage shall provide a positive direct connection between the wall and floor, roof, or supporting member capable of resisting horizontal forces specified in this section for structures with flexible diaphragms or of Sec. 6.2.2 (using a_p equal to 1.0 and R_p equal to 2.5) for structures with diaphragms that are not flexible.

Anchorage of walls to flexible diaphragms shall have the strength to develop the out-of-plane force given by Eq. 4.6-1 as follows:

$$F_p = 0.8S_{DS}IW_p \quad (4.6-1)$$

where:

- F_p = the design force in the individual anchors,
- S_{DS} = the design spectral response acceleration parameter at short periods as defined in Sec. 3.3.3,
- I = the occupancy importance factor as defined in Sec. 1.3, and
- W_p = the weight of the wall tributary to the anchor.

Diaphragms shall be provided with continuous ties or struts between diaphragm chords to distribute these anchorage forces into the diaphragms. Added chords are permitted to be used to form subdiaphragms to transmit the anchorage forces to the main continuous cross ties. The maximum length-to-width ratio of the structural subdiaphragm shall be 2.5 to 1. Connections and anchorages capable of resisting the prescribed forces shall be provided between the diaphragm and the attached components. Connections shall extend into the diaphragm a sufficient distance to develop the force transferred into the diaphragm.

In wood diaphragms, the continuous ties shall be in addition to the diaphragm sheathing. Anchorage shall not be accomplished by use of toe nails or nails subject to withdrawal nor shall wood ledgers of framing be used in cross-grain bending or cross-grain tension. The diaphragm sheathing shall not be considered as effectively providing the ties or struts required by this section.

In metal deck diaphragms, the metal deck shall not be used as the continuous ties required by this section in the direction perpendicular to the deck span.

Diaphragm to wall anchorage using embedded straps shall be attached to or hooked around the reinforcing steel or otherwise terminated so as to effectively transfer forces to the reinforcing steel.

4.6.2.2 Collector elements. In addition to the requirements of Sec. 4.6.1.8, collector elements, splices, and their connections to resisting elements shall be designed to resist the forces defined in Sec. 4.2.2.2.

Exception: In structures or portions thereof braced entirely by light-frame shear walls, collector elements, splices, and connections to resisting elements are permitted to be designed to resist the forces determined in accordance with Sec. 4.6.3.4.

4.6.3 Seismic Design Categories D, E, and F. Structures assigned to Seismic Design Category D, E, or F shall conform to the requirements of Sec. 4.6.2 and to the requirements of this section.

4.6.3.1 Vertical seismic forces. The vertical component of earthquake ground motion shall be considered in the design of horizontal cantilever and horizontal prestressed components. The load combinations used in evaluating such components shall include E as defined by Eq. 4.2-1 and 4.2-2. Horizontal cantilever structural components shall be designed for a minimum net upward force of 0.2 times the dead load in addition to the applicable load combinations of Sec. 4.2.2.

4.6.3.2 Plan or vertical irregularities. The design shall consider the potential for adverse effects where the ratio of the strength provided in any story to the strength required is significantly less than that ratio for the story immediately above and the strengths shall be adjusted to compensate for this effect.

For structures having a plan structural irregularity of Type 1a, 1b, 2, 3, or 4 in Table 4.3-2 or a vertical structural irregularity of Type 4 in Table 4.3-3, the design forces determined from the structural analysis performed in accordance with Sec. 4.4 shall be increased 25 percent for connections of diaphragms to vertical elements and to collectors. Collector forces determined in accordance with Sec. 4.6.3.4 (but not those determined in accordance with Sec. 4.2.2.2) shall be subject to this increase.

4.6.3.3 Collector elements. In addition to the requirements of Sec. 4.6.2.2, collector elements, splices, and their connections to resisting elements shall resist the forces determined in accordance with Sec. 4.6.3.4.

4.6.3.4 Diaphragms. Diaphragms shall be designed to resist design seismic forces determined in accordance with Eq. 4.6-2 as follows:

$$F_{px} = \frac{\sum_{i=x}^n F_i}{\sum_{i=x}^n w_i} w_{px} \quad (4.6-2)$$

where:

- F_{px} = the diaphragm design force at Level x ,
- F_i = the design force applied to Level i ,
- w_i = the weight tributary to Level i , and
- w_{px} = the weight tributary to the diaphragm at Level x .

The force determined from Eq. 4.6-2 need not exceed $0.4S_{DS}Iw_{px}$ but shall not be less than $0.2S_{DS}Iw_{px}$. Where the diaphragm is required to transfer design seismic force from the vertical-resisting elements above the diaphragm to other vertical-resisting elements below the diaphragm due to offsets in the placement of the elements or to changes in relative lateral stiffness in the vertical elements, these forces shall be added to those determined from Eq. 4.6-2.

ALTERNATIVE SIMPLIFIED CHAPTER 4:

ALTERNATIVE STRUCTURAL DESIGN CRITERIA FOR SIMPLE BEARING WALL OR BUILDING FRAME SYSTEMS

Alt.4.1 GENERAL

Alt. 4.1.1 Simplified design procedure. Simple bearing wall and building frame systems and their components meeting the qualifications of this section shall be permitted to be designed as prescribed in this chapter as an alternative to the Provisions of Chapter 4, and 5. This chapter also provides alternative procedures for determining site class and site coefficients. The Seismic Design Category shall be determined from Table 1.4-1 using the value of S_{DS} from Section Alt. 4.6.1. Application of this Alternative Simplified Chapter is subject to all of the following limitations:

1. Structure shall qualify for Seismic Use Group I.
2. The Site Class, defined in Sec. 3.5, shall not be Class E or F.
3. Structure shall not exceed three stories in height above grade.
4. Seismic-force resisting system shall be either a Bearing Wall System or Building Frame System, as indicated in Alt. Table 4.3.1
5. The structure shall have at least two lines of lateral resistance in each of two major axis directions.
6. At least one line of resistance shall be provided on each side of the center of mass in each direction.
7. The sum of the strengths of the lines of resistance on each side of the center of mass shall equal at least 40 percent of the story shear.
8. For buildings with a diaphragm that is not flexible, the distance between the center of rigidity and the center of mass parallel to each major axis shall not exceed 15 percent of the greatest width of the diaphragm parallel to that axis.
9. Lines of resistance of the lateral-force-resisting system shall be oriented at angles of no more than 15 degrees from alignment with the major orthogonal horizontal axes of the building.
10. The alternative simplified design procedure shall be used for each major orthogonal horizontal axis direction of the building.
11. System irregularities caused by in-plane or out-of-plane offsets of lateral force-resisting elements shall not be permitted.
12. The lateral-load-resistance of any story shall not be less than 80 percent of the story above.

Alt. 4.1.2 References. The reference documents listed in Sec 4.1.2 shall be used as indicated in this Simplified Alternate Chapter 4.

Alt. 4.1.3 Definitions. The definitions listed in Sec. 4.1.3 shall be used for this Alternative Simplified Chapter 4 in addition to the following:

Major orthogonal horizontal directions: The orthogonal directions that overlay the majority of lateral force resisting elements.

Alt. 4.1.4 Notation

D	The effect of dead load.
E	The effect of horizontal and vertical earthquake-induced forces.
F_i	The portion of the seismic base shear, V , induced at Level i .
F_p	The seismic design force applicable to a particular structural component.
F_x	See Sec. 1.1.5.
h_i	The height above the base to Level i .
h_x	The height above the base to Level x .
I	See Sec. 1.1.5.
Level i	The building level referred to by the subscript i ; $i = 1$ designates the first level above the base.
Level n	The level that is uppermost in the main portion of the of the building.
Level x	See Sec. 1.1.5.
Q_E	The effect of horizontal seismic forces.
R	The response modification coefficient as given in Table 4.3-1.
S_{DS}	See Sec. 3.1.4.
S_S	See Sec 3.3.1.
V	The total design shear at the base of the structure in the direction of interest, as determined using the procedure of A4.6.1
V_x	The seismic design shear in Story x . See Sec. A4.6.3.
W	See Sec. 1.1.5.
W_c	Weight of wall.
W_p	Weight of structural component.
w_i	The portion of the seismic weight, W , located at or assigned to Level i .
w_x	See Sec. 1.1.5.

Alt. 4.2 DESIGN BASIS

Alt. 4.2.1 General. The structure shall include complete lateral and vertical-force-resisting systems capable of providing adequate strength, stiffness, and energy dissipation capacity to withstand the design ground motions within the prescribed limits of strength demand. The adequacy of the structural systems shall be demonstrated through construction of a mathematical model and evaluation of this model for the effects of the design ground motions. This evaluation shall consist of a linear elastic analysis in which design seismic forces are distributed and applied throughout the height of the structure in accordance with the procedures of Sec. Alt. 4.6. The corresponding internal forces in all members of the structure shall be determined and evaluated against acceptance criteria contained in these *Provisions*.

Individual members shall be provided with adequate strength to resist the shears, axial forces, and moments determined in accordance with these *Provisions*. A continuous load path, or paths, with adequate strength and stiffness shall be provided to transfer all forces from the point of application to the final point of resistance. The foundation shall be designed to accommodate the forces developed or the movements imparted to the structure by the design ground motions.

Alt. 4.2.2 Combination of Load Effects. The effects on the structure and its components due to gravity loads and seismic forces shall be combined in accordance with the factored load combinations as presented in ASCE 7-02, except that the effect of seismic loads, E , shall be as defined herein.

Alt. 4.2.2.1 Seismic load effect. The effect of seismic load E shall be defined by Eq. Alt. 4.2-1 as follows for load combinations in which the effects of gravity loads and seismic loads are additive:

$$E = Q_E + 0.2S_{DS}D \quad (\text{Alt. 4.2-1})$$

where:

E = the effect of horizontal and vertical earthquake-induced forces,

S_{DS} = the design spectral response acceleration at short periods obtained from
Sec. Alt. 4.6.1

D = the effect of dead load, and

Q_E = the effect of horizontal seismic forces.

The effect of seismic load E shall be defined by Eq. Alt. 4.2-2 as follows for load combinations in which the effects of gravity counteract seismic load:

$$E = Q_E - 0.2S_{DS}D \quad (\text{Alt.4.2-2})$$

where E , Q_E , S_{DS} , and D are as defined above.

Alt. 4.2.2.2 Seismic load effect with overstrength. Where specifically required by these *Provisions*, the design seismic force on components sensitive to the effects of structural overstrength shall be as defined by Eq. 4.2-3 and 4.2-4 for load combinations in which the effects of gravity are respectively additive with or counteractive to the effect of seismic loads:

$$E = \Omega_0 Q_E + 0.2S_{DS}D \quad (\text{Alt. 4.2-3})$$

$$E = \Omega_0 Q_E - 0.2S_{DS}D \quad (\text{Alt. 4.2-4})$$

where E , Q_E , S_{DS} , and D are as defined above. Ω_0 shall be taken as 2-1/2.

Alt. 4.3 SEISMIC-FORCE-RESISTING SYSTEM

Alt. 4.3.1 Selection and Limitations. The basic lateral and vertical seismic-force-resisting system shall conform to one of the types indicated in Alt. Table 4.3.1. Each type is subdivided by the type of vertical element used to resist lateral seismic forces. The appropriate response modification coefficient, R , indicated in Alt. Table 4.3.1 shall be used in determining the base shear and element design forces as indicated in these *Provisions*.

Special framing and detailing requirements are indicated in Sec. Alt. 4.5 and in Chapters 8, 9, 10, 11, and 12 for structures assigned to the various Seismic Design Categories.

Alt. Table 4.3-1 Design Coefficients and Factors for Basic Seismic-Force-Resisting Systems

Basic Seismic-Force-Resisting System	Detailing Reference Section	R^a	System Limitations by Seismic Design Category ^b		
			B	C	D,E
Bearing Wall Systems					
Special reinforced concrete shear walls	9.2.1.6	5	P	P	P
Ordinary reinforced concrete shear walls	9.2.1.4	4	P	P	NP
Detailed plain concrete shear walls	9.2.1.2	2	P	NP	NP
Ordinary plain concrete shear walls	9.2.1.1	1½	P	NP	NP
Intermediate precast shear walls	9.2.1.5	4	P	P	P
Ordinary precast shear walls	9.2.1.3	3	P	NP	NP
Special reinforced masonry shear walls	11.5.6.3	3½	P	P	P
Intermediate reinforced masonry shear walls	11.5.6.2	2½	P	P	NP
Ordinary reinforced masonry shear walls	11.5.6.1	2	P	NP	NP
Detailed plain masonry shear walls	11.4.4.2	2	P	NP	NP
Ordinary plain masonry shear walls	11.4.4.1	1½	P	NP	NP
Prestressed masonry shear walls	11.9	1½	P	NP	NP
Light-frame walls with shear panels	8.4, 12.3.3, 12.4	6½	P	P	P
Light-frame walls with diagonal braces	8.4.2	4	P	P	P
Building Frame Systems					
Special steel concentrically braced frames	AISC Seismic, Part I, Sec. 13	6	P	P	P
Ordinary steel concentrically braced frames	AISC Seismic, Part I, Sec. 14	5	P	P	P
Special reinforced concrete shear walls	9.2.1.6	6	P	P	P

Alternative Structural Design Criteria for Simple Bearing Wall or Building Frame Systems

Ordinary reinforced concrete shear walls	9.2.1.4	5	P	P	NP
Detailed plain concrete shear walls	9.2.1.2	2½	P	NP	NP
Ordinary plain concrete shear walls	9.2.1.1	1½	P	NP	NP
Intermediate precast shear walls	9.2.1.5	5	P	P	P
Ordinary precast shear walls	9.2.1.3	4	P	NP	NP
Composite concentrically braced frames	AISC Seismic, Part II, Sec. 12	5	P	P	P
Ordinary composite braced frames	AISC Seismic, Part II, Sec. 13	3	P	P	NP
Composite steel plate shear walls	AISC Seismic, Part II, Sec. 17	6½	P	P	P
Special steel plate shear walls		7	P	P	P
Special composite reinforced concrete shear walls with steel elements	AISC Seismic, Part II, Sec. 16	6	P	P	P
Ordinary composite reinforced concrete shear walls with steel elements	AISC Seismic, Part II, Sec. 15	5	P	P	NP
Special reinforced masonry shear walls	11.5.6.3	4½	P	P	P
Intermediate reinforced masonry shear walls	11.5.6.2	3	P	P	NP
Ordinary reinforced masonry shear walls	11.5.6.1	2	P	NP	NP
Detailed plain masonry shear walls	11.4.4.2	2	P	NP	Np
Ordinary plain masonry shear walls	11.4.4.1	1½	P	NP	NP
Prestressed masonry shear walls	11.9	1½	P	NP	NP
Light-frame walls with shear panels	8.4, 12.3.3, 12.4	7	P	P	P
Steel Systems Not Specifically Detailed for Seismic Resistance (Concentric Braced Frame systems only)	AISC ASD, AISC LRFD, AISI	3	P	P	NP
^a Response modification coefficient, <i>R</i> , for use throughout these <i>Provisions</i> .					
^b P = Permitted and NP = Not Permitted.					

Alt. 4.3.1.1 Combinations of Framing Systems. A combination of different structural systems shall not be utilized to resist lateral forces in the same direction. Seismic-force-resisting systems are permitted to

differ between the two major horizontal axes of the structure, provided that systems shall not be vertically combined from story to story.

Exception: Penthouses and other rooftop-supported structures weighing less than 25% of the roof level need not be considered a story. The limitations of Sec 4.1.1 do not apply to these structures. The value of R used for combinations of different systems shall not be greater than the least value of any of the systems utilized in the same direction. The systems utilized may differ from those of the supporting structure below.

Alt. 4.3.1.1.2 Combination Framing Detailing Requirements. The detailing requirements of Sec. Alt. 4.5 required by the higher response modification coefficient, R , shall be used for structural components common to systems having different response modification coefficients.

Alt. 4.3.2 Diaphragm Flexibility. Diaphragms constructed of untopped steel decking, wood structural panels or similar panelized construction may be considered flexible.

Alt. 4.4 APPLICATION OF LOADING The effects of the combination of loads shall be considered as prescribed in Sec. Alt. 4.2.2. The design seismic forces are permitted to be applied separately in each orthogonal direction and the combination of effects from the two directions need not be considered. Reversal of load shall be considered.

Alt. 4.5 DESIGN AND DETAILING REQUIREMENTS The design and detailing of the components of the seismic-force-resisting system shall comply with the requirements of this section. Foundation design shall conform to the applicable requirements of Chapter 7. The materials and the systems composed of those materials shall conform to the applicable requirements and limitations found elsewhere in these Provisions.

Alt. 4.5.1 Connections. All parts of the structure between separation joints shall be inter-connected, and the connection shall be capable of transmitting the seismic force, F_p , induced by the parts being connected. Any smaller portion of the structure shall be tied to the remainder of the structure with elements having a strength of 0.20 times the short period design spectral response acceleration coefficient, S_{DS} , times the weight of the smaller portion or 5 percent of the portion's weight, whichever is greater.

A positive connection for resisting a horizontal force acting parallel to the member shall be provided for each beam, girder, or truss to its support. The connections shall have a minimum strength of 5 percent of the dead load and live load reaction.

Alt. 4.5.2 Openings or Re-entrant Building Corners. Except where as otherwise specifically provided for in these provisions, openings in shear walls, diaphragms or other plate-type elements, shall be provided with reinforcement at the edges of the openings designed to transfer the stresses into the structure. The edge reinforcement shall extend into the body of the wall or diaphragm a distance sufficient to develop the force in the reinforcement.

Alt. 4.5.3 Collector Elements. Collector elements shall be provided with adequate strength to transfer the seismic forces originating in other portions of the structure to the element providing the resistance to those forces. Collector elements, splices, and their connections to resisting elements shall be designed to resist the forces defined in Sec. Alt. 4.2.2.2.

Exception: In structures or portions thereof braced entirely by light-frame shear walls, collector elements, splices, and connections to resisting elements are permitted to be designed to resist forces in accordance with Sec. Alt. 4.5.4.

Alt. 4.5.4 Diaphragms. Floor and roof diaphragms shall be designed to resist the design seismic forces at each level, F_x , calculated in accordance with Sec. Alt. 4.6.2. When the diaphragm is required to transfer design seismic forces from the vertical-resisting elements above the diaphragm to other vertical-

resisting elements below the diaphragm due to changes in relative lateral stiffness in the vertical elements, the transferred portion of the seismic shear force at that level, V_x , shall be added to the diaphragm design force. Diaphragms shall provide for both the shear and bending stresses resulting from these forces. Diaphragms shall have ties or struts to distribute the wall anchorage forces into the diaphragm. Diaphragm connections shall be positive, mechanical or welded type connections.

Alt. 4.5.5 Anchorage of Concrete or Masonry Walls

Alt. 4.5.5.1 Seismic Design Category B. Concrete or masonry walls shall be connected, using reinforcement or anchors, to the roof and all floors and members that provide lateral support for the wall or that are supported by the wall. The connection shall be capable of resisting a seismic lateral force induced by the wall of 100 pounds per lineal foot (1500 K/m). Walls shall be designed to resist bending between connections where the spacing exceeds 4 ft (1.2 m).

Alt. 4.5.5.2 Seismic Design Category C and D. In addition to the requirements of Sec. Alt 4.5.5.1, concrete or masonry walls shall be anchored in accordance with this section.. The anchorage shall provide a positive direct connection between the wall and floor, roof, or supporting member capable of resisting horizontal forces specified in this section for structures with flexible diaphragms or of Sec. 6.2.2 (using a_p equal to 1.0 and R_p equal to 2.5) for structures with diaphragms that are not flexible.

Anchorage of walls to flexible diaphragms shall have the strength to develop the out-of-plane force given by Eq. A4.5-1:

$$F_p = 0.8 S_{DS} W_p \quad (\text{Alt. 4.5-1})$$

where:

F_p = the design force in the individual anchors,

S_{DS} = the design spectral response acceleration at short periods per Sec. Alt. 4.6.1, and

W_p = the weight of the wall tributary to the anchor

Diaphragms shall be provided with continuous ties or struts between diaphragm chords to distribute these anchorage forces into the diaphragms. Added chords are permitted to be used to form subdiaphragms to transmit the anchorage forces to the main continuous cross ties. The maximum length to width ratio of the structural subdiaphragm shall be 2-1/2 to 1. Connections and anchorages capable of resisting the prescribed forces shall be provided between the diaphragm and the attached components. Connections shall extend into the diaphragm a sufficient distance to develop the force transferred into the diaphragm.

In wood diaphragms, the continuous ties shall be in addition to the diaphragm sheathing. Anchorage shall not be accomplished by use of toe nails or nails subject to withdrawal nor shall wood ledgers of framing be used in cross-grain bending or cross-grain tension. The diaphragm sheathing shall not be considered effective as providing the ties or struts required by this section.

In metal deck diaphragms, the metal deck shall not be used as the continuous ties required by this section in the direction perpendicular to the deck span.

Diaphragm to wall anchorage using embedded straps shall be attached to or hooked around the reinforcing steel or otherwise terminated so as to effectively transfer forces to the reinforcing steel.

Alt. 4.5.6 Bearing Walls. Exterior and interior bearing walls and their anchorage shall be designed for a force equal to 40 percent of the short period design spectral response acceleration S_{DS} times the weight of wall, W_c , normal to the surface, with a minimum force of 10 percent of the weight of the wall.

Interconnection of wall elements and connections to supporting framing systems shall have sufficient ductility, rotational capacity, or sufficient strength to resist shrinkage, thermal changes, and differential foundation settlement when combined with seismic forces.

Alt. 4.5.7 Anchorage of Nonstructural Systems. When required by Chapter 6, all portions or components of the structure shall be anchored for the seismic force, F_p , prescribed therein.

Alt. 4.6 SIMPLIFIED LATERAL FORCE ANALYSIS PROCEDURE An equivalent lateral force analysis shall consist of the application of equivalent static lateral forces to a linear mathematical model of the structure. The lateral forces applied in each direction shall sum to a total seismic base shear given by Sec. Alt. 4.6.1 and shall be distributed vertically in accordance with Sec. Alt. 4.6.2. For purposes of analysis, the structure shall be considered fixed at the base.

Alt. 4.6.1 Seismic Base Shear

The seismic base shear, V , in a given direction shall be determined in accordance with formula Alt. 4.6-1:

$$V = \frac{1.25S_{DS}}{R}W \quad (\text{Alt. 4.6-1})$$

where:

$S_{DS} = 2/3F_aS_s$, where F_a may be taken as 1.0 for rock sites, 1.4 for soil sites, or determined in accordance with Section 3.3.2. For the purpose of this section, sites may be considered to be rock if there is no more than 10 ft (3 m) of soil between the rock surface and the bottom of spread footing or mat foundation. In calculating S_{DS} , S_s need not be taken larger than 1.5.

R = the response modification factor from Table A4.3.1 and

W = the total dead load and applicable portions of other loads listed below:

1. In areas used for storage, a minimum of 25 percent of the floor live load shall be applicable. The live load may be reduced for tributary area as permitted by the structural code administered by the authority having jurisdiction. Floor live load in public garages and open parking structures is not applicable.
2. Where an allowance for partition load is included in the floor load design, the actual partition weight or a minimum weight of 10 psf (500 Pa/m²) of floor area, whichever is greater, shall be applicable.
3. Total operating weight of permanent equipment.
4. In areas where the design flat roof snow load does not exceed 30 pounds per square foot, the effective snow load is permitted to be taken as zero. In areas where the design snow load is greater than 30 pounds per square foot and where siting and load duration conditions warrant and when approved by the authority having jurisdiction, the effective snow load is permitted to be reduced to not less than 20 percent of the design snow load.

Alt. 4.6.2 Vertical distribution. The forces at each level shall be calculated using the following formula:

$$F_x = \frac{1.25S_{DS}}{R}w_x \quad (\text{Alt. 4.6-2})$$

where w_x = the portion of the effective seismic weight of the structure, W at Level x .

Alt. 4.6.3 Horizontal Shear Distribution. The seismic design story shear in any story, V_x (kip or kN), shall be determined from the following equation:

$$V_x = \sum_{i=x}^n F_i \quad (\text{Alt. 4.6-3})$$

where F_i = the portion of the seismic base shear, V (kip or kN) induced at Level i .

Alt. 4.6.3.1 Flexible Diaphragm Structures. The seismic design story shear in stories of structures with flexible diaphragms, as defined in Sec. Alt. 4.3.2, shall be distributed to the vertical elements of the lateral force resisting system using tributary area rules. Two-dimensional analysis shall be permitted where diaphragms are flexible.

Alt. 4.6.3.2 Structures with Diaphragms that are not Flexible. For structures with diaphragms that are not flexible, as defined in Sec. Alt. 4.3.2, the seismic design story shear, V_x , (kip or kN) shall be distributed to the various vertical elements of the seismic-force-resisting system in the story under consideration based on the relative lateral stiffnesses of the vertical elements and the diaphragm.

Alt. 4.6.3.2.1 Torsion. The design of structures with diaphragms that are not flexible shall include the torsional moment, M_t (kip-ft or KN-m) resulting from eccentric location of the masses.

Alt. 4.6.4 Overturning. The structure shall be designed to resist overturning effects caused by the seismic forces determined in Sec. Alt. 4.6.2. At any story, the increment of overturning moment in the story under consideration shall be distributed to the various vertical force-resisting elements in the same proportion as the distribution of the horizontal shears to those elements.

The overturning moments at Level x , M_x (kip-ft or kN-m) shall be determined from the following equation:

$$M_x = \sum_{i=x}^n F_i (h_i - h_x) \quad (\text{Alt.4.6-4})$$

where:

F_i = the portion of the seismic base shear, V , induced at Level i , and

h_i and h_x = the height (ft or m) from the base to Level i or x .

The foundations of structures shall be designed for 75% of the foundation overturning design moment, M_f (kip-ft or kN-m) at the foundation-soil interface.

Alt. 4.6.5 Drift Limits and Building Separation. Structural drift need not be calculated. When a drift value is needed for use in material standards to determine structural separations between buildings, for design of cladding, or for other design requirements, it shall be taken as 1% of building height. All portions of the structure shall be designed to act as an integral unit in resisting seismic forces unless separated structurally by a distance sufficient to avoid damaging contact under the total deflection, δ_x , as defined in Sec 5.2.6.1.

This page is intentionally left blank.

Chapter 5

STRUCTURAL ANALYSIS PROCEDURES

5.1 GENERAL

5.1.1 Scope. This chapter provides minimum requirements for the structural analysis procedures prescribed in Sec. 4.4.1. If the alternate design procedure of Alternative Simplified Chapter 4 is used, this chapter does not apply.

5.1.2 Definitions

Base: See Sec. 4.1.3.

Base shear: See Sec. 4.1.3.

Building: See Sec. 4.1.3.

Component: See Sec. 1.1.4.

Dead load: See Sec. 4.1.3.

Design earthquake ground motion: See Sec. 1.1.4.

Design strength: See Sec. 4.1.3.

Diaphragm: See Sec. 4.1.3.

Eccentrically braced frame (EBF): See Sec. 4.1.3.

Inverted pendulum-type structures: See Sec. 4.1.3.

Live load: See Sec. 4.1.3.

Maximum considered earthquake ground motion: See Sec. 3.1.3.

Moment frame: See Sec. 4.1.3.

Nominal strength: See Sec. 4.1.3.

Occupancy importance factor: See Sec. 1.1.4.

Partition: A nonstructural interior wall that spans from floor to ceiling, to the floor or roof structure immediately above, or to subsidiary structural members attached to the structure above.

P-delta effect: The secondary effect on shears and moments of structural members induced due to displacement of the structure.

Registered design professional: See Sec. 2.1.3.

Required strength: See Sec. 4.1.3.

Seismic Design Category: See Sec. 1.1.4.

Seismic-force-resisting system: See Sec. 1.1.4.

Seismic forces: See Sec. 1.1.4.

Seismic response coefficient: Coefficient C_S as determined in Sec. 5.2.2.1.

Shear wall: See Sec. 4.1.3.

Story: See Sec. 4.1.3.

Story shear: The summation of design lateral forces at levels above the story under consideration.

Structure: See Sec. 1.1.4.

5.1.3 Notation

A_o	The area of the load-carrying foundation.
A_B	The base area of the structure.
A_i	The area of shear wall i .
A_x	The torsional amplification factor.
a_d	The incremental factor related to P -delta effects in Sec. 5.2.6.2.
C_d	See Sec. 4.1.4.
C_r	The approximate period coefficient given in Sec. 5.2.2.1.
C_S	The seismic response coefficient.
C_{Sm}	The modal seismic response coefficient determined in Sec. 5.3.4.
C_u	Coefficient for upper limit on calculated period given in Table 5.2-1.
C_{vx}	The vertical distribution factor given in Sec. 5.2.3.
C_{vxm}	The vertical distribution factor in the m th mode given in Sec. 5.3.5.
C_w	The effective shear wall area coefficient defined in Sec. 5.2.2.1.
D_s	The total depth of the stratum in Eq. 5.6-10.
F_i	See Sec. 4.1.4.
F_x	See Sec. 1.1.5.
F_{xm}	The portion of the seismic base shear, V_m , induced at a Level x as determined in Sec. 5.3.5.
G	γ_s^2/g = the average shear modulus for the soils beneath the foundation at large strain levels.
G_o	γ_{so}^2/g = the average shear modulus for the soils beneath the foundation at small strain levels.
h_i	The height above the base to Level i .
h_n	The height above the base to the highest level of the structure.
h_x	The height above the base to Level x .
\bar{h}	The effective height of the structure as defined in Sec. 5.6.2.1.1.
I	See Sec. 1.1.5.
I_o	The static moment of inertia of the load-carrying foundation, see Sec. 5.6.2.1.1.
k	The distribution exponent given in Sec. 5.2.3.
\bar{k}	The stiffness of the fixed-base structure as defined in Sec. 5.6.2.1.1.
K_y	The lateral stiffness of the foundation as defined in Sec. 5.6.2.1.1.
K_θ	The rocking stiffness of the foundation as defined in Sec. 5.6.2.1.1.
L_i	The length of shear wall i .
L_o	The overall length of the side of the foundation in the direction being analyzed, Sec. 5.6.2.1.2.
M_o, M_{o1}	The overturning moment at the foundation-soil interface as determined in Sec. 5.2.5 and 5.3.6.

M_t	The torsional moment resulting from the location of the building masses, Sec. 5.2.4.1.
M_{ta}	The accidental torsional moment as determined in Sec. 5.2.4.2.
m	A subscript denoting the mode of vibration under consideration; i.e., $m=1$ for the fundamental mode.
N	Number of stories.
P_x	The total unfactored vertical design load at and above level x .
Q_E	See Sec. 4.1.4.
R	See Sec. 4.1.4.
r_a	The characteristic foundation length defined by Eq. 5.6-7.
r_m	The characteristic foundation length as defined by Eq. 5.6-8.
S_I	See Sec. 3.1.4.
S_{am}	The design spectral response acceleration at the period corresponding to mode m .
S_{DI}	See Sec. 3.1.4.
S_{DS}	See Sec. 3.1.4.
T	See Sec. 4.1.4.
\tilde{T}	The effective period of the flexibly supported structure as determined by Eq. 5.6-3.
T_a	The approximate fundamental period of the building as determined in Sec. 5.2.2.1.
T_m	The period of the m^{th} mode of vibration of the structure in the direction of interest.
V	The total design shear at the base of the structure in the direction of interest, as determined using the procedure of Sec. 5.2, including Sec. 5.2.1.
V_I	The portion of seismic base shear, V , contributed by the fundamental mode.
V_t	The design value of the seismic base shear as determined in Sec. 5.3.7.
V_x	The seismic design shear in Story x .
\tilde{V}	The total design base shear including consideration of soil-structure interaction.
ΔV	The reduction in V as determined in Sec. 5.6.2.1.
ΔV_I	The reduction of V_I as determined in Sec. 5.6.3.1.
v_s	See Sec. 3.1.4.
v_{so}	The average shear wave velocity for the soils beneath the foundation at small strain levels.
W	See Sec. 1.1.5.
\bar{W}	The effective seismic weight as defined in Sec. 5.6.2.1 and 5.6.3.1.
\bar{W}_m	The effective seismic weight of the m^{th} mode of vibration of the structure determined in accordance with Eq. 5.3-2.
w_i	See Sec. 4.1.4.
w_x	See Sec. 1.1.5.
Level x	See Sec. 1.1.5.
α	The relative weight density of the structure and the soil as determined in Sec. 5.6.2.1.1.

α_θ	The dynamic foundation stiffness modifier for rocking (see <i>Commentary</i>).
$\tilde{\beta}$	The fraction of critical damping for the coupled structure-foundation system, determined in Sec. 5.6.2.1.2.
β_o	The foundation damping factor as specified in Sec. 5.6.2.1.2.
γ	The average unit weight of soil.
γ	The member inelastic deformations.
Δ	See Sec. 4.1.4.
$\tilde{\Delta}_m$	The modal story drift including the effects of soil-structure interaction.
δ_{avg}	The average of the displacements at the extreme points of the structure at Level x .
δ_{max}	The maximum displacement at Level x .
δ_{xm}	The modal deflection of Level x at the center of the mass at and above Level x , as determined by Eq. 5.3-8.
$\bar{\delta}_{x1}$	The modified modal deflections (for the first mode) as determined by Eq. 5.6-14.
$\bar{\delta}_{xm}$	The modified modal deflections (for mode m) as determined by Eq. 5.6-15.
θ	The stability coefficient for P -delta effects as determined in Sec. 5.2.6.2.
θ_{max}	The maximum permitted stability coefficient as determined by Eq. 5.2-17.
τ	The overturning moment reduction factor.
ϕ	The strength reduction, capacity reduction, or resistance factor.
Ω_0	See Sec. 4.1.4.

5.2 EQUIVALENT LATERAL FORCE PROCEDURE

An equivalent lateral force analysis shall consist of the application of equivalent static lateral forces to a linear mathematical model of the structure. The lateral forces applied in each direction shall sum to a total seismic base shear given by Sec. 5.2.1 and shall be distributed vertically in accordance with Sec. 5.2.3. For purposes of analysis, the structure shall be considered fixed at the base.

5.2.1 Seismic base shear. The seismic base shear, V , in a given direction shall be determined in accordance with the following equation:

$$V = C_s W \quad (5.2-1)$$

where:

C_s = the seismic response coefficient determined in accordance with Sec. 5.2.1.1 and

W = the total dead load and applicable portions of other loads listed below:

1. In areas used for storage, a minimum of 25 percent of the floor live load shall be applicable. Floor live load in public garages and open parking structures is not applicable.
2. Where an allowance for partition load is included in the floor load design, the actual partition weight or a minimum weight of 10 psf (0.500 kN/m²) of floor area, whichever is greater, shall be applicable.
3. Total operating weight of permanent equipment.

4. In areas where the design flat roof snow load does not exceed 30 pounds per square foot, the effective snow load is permitted to be taken as zero. In areas where the design snow load is greater than 30 psf (1.4 kN/m²), where siting and load duration conditions warrant, and where approved by the authority having jurisdiction, the effective snow load is permitted to be reduced to not less than 20 percent of the design snow load.

5.2.1.1 Calculation of seismic response coefficient. The seismic response coefficient, C_s , shall be determined in accordance with the following equation:

$$C_s = \frac{S_{DS}}{R/I} \quad (5.2-2)$$

where:

S_{DS} = the design spectral response acceleration parameter in the short period range as determined from Sec. 3.3.3,

R = the response modification factor from Table 4.3-1, and

I = the occupancy importance factor determined in accordance with Sec. 1.3.

The value of the seismic response coefficient computed in accordance with Eq. 5.2-2 need not exceed the following:

$$C_s = \frac{S_{D1}}{T(R/I)} \text{ for } T \leq T_L \quad (5.2-3)$$

$$C_s = \frac{S_{D1}T_L}{T^2(R/I)} \text{ for } T > T_L \quad (5.2-4)$$

where R and I are as defined above and

S_{D1} = the design spectral response acceleration parameter at a period of 1.0 second as determined from Sec. 3.3.3,

T = the fundamental period of the structure (in seconds) determined in Sec. 5.2.2, and

T_L = Long-period transition period (in seconds) determined in Sec. 3.3.1

C_s shall not be taken less than 0.01.

For buildings and structures located where S_I is equal to or greater than 0.6g, C_s shall not be taken less than:

$$C_s = \frac{0.5S_I}{R/I} \quad (5.2-5)$$

where R and I are as defined above and

S_I = the mapped maximum considered earthquake spectral response acceleration parameter determined in accordance with Sec. 3.3.1.

For regular structures 5 stories or less in height and having a period, T , of 0.5 seconds or less, the seismic response coefficient, C_s , shall be permitted to be calculated using values of 1.5 and 0.6, respectively, for the mapped maximum considered earthquake spectral response acceleration parameters S_S and S_I .

A soil-structure interaction reduction is permitted where determined using Sec. 5.6 or other generally accepted procedures approved by the authority having jurisdiction.

5.2.2 Period determination. The fundamental period of the building, T , in the direction under consideration shall be established using the structural properties and deformational characteristics of the resisting elements in a properly substantiated analysis. The fundamental period, T , so calculated, shall not exceed the product of C_u , from Table 5.2-1, and T_a , calculated in accordance with Sec. 5.2.2.1. As an alternative to performing an analysis to determine the fundamental period of the structure, T , it shall be permitted to use the approximate period equations of Sec. 5.2.2.1 directly.

Table 5.2-1 Coefficient for Upper Limit on Calculated Period

Value of S_{DI} ^a	C_u
$S_{DI} \geq 0.4$	1.4
$S_{DI} = 0.3$	1.4
$S_{DI} = 0.2$	1.5
$S_{DI} = 0.15$	1.6
$S_{DI} \leq 0.1$	1.7

Note: ^a Use straight line interpolation for intermediate values of S_{DI} .

5.2.2.1 Approximate fundamental period. The approximate fundamental period, T_a , in seconds, shall be determined from the following equation:

$$T_a = C_r h_n^x \quad (5.2-6)$$

where h_n is the height in feet (meters) above the base to the highest level of the structure and the values of C_r and x shall be determined from Table 5.2-2.

Table 5.2-2 Values of Approximate Period Parameters C_r and x

Structure Type	C_r	x
Moment resisting frame systems of steel in which the frames resist 100 percent of the required seismic force and are not enclosed or adjoined by more rigid components that will prevent the frames from deflecting where subjected to seismic forces.	0.028 (metric 0.0724)	0.8
Moment resisting frame systems of reinforced concrete in which the frames resist 100 percent of the required seismic force and are not enclosed or adjoined by more rigid components that will prevent the frames from deflecting where subjected to seismic forces.	0.016 (metric 0.0466)	0.9
Eccentrically braced steel frames and buckling restrained braced frames	0.03 (metric 0.0731)	0.75
All other structural systems	0.02 (metric 0.0488)	0.75

Alternatively, the approximate fundamental period, T_a , in seconds, is permitted to be determined from the following equation for concrete and steel moment resisting frame structures not exceeding 12 stories in height and having a minimum story height of not less than 10 ft (3 m):

$$T_a = 0.1N \quad (5.2-7)$$

where N = number of stories.

The approximate fundamental period, T_a , in seconds, for masonry or concrete shear wall structures is permitted to be determined from the following equation:

$$T_a = \frac{0.0019}{\sqrt{C_w}} h_n \quad (5.2-8)$$

where C_w is a coefficient related to the effective shear wall area and h_n is as defined above. The metric equivalent of Eq. 5.2-8 is:

$$T_a = \frac{0.0062}{\sqrt{C_w}} h_n$$

The coefficient C_w shall be calculated from the following equation:

$$C_w = \frac{100}{A_B} \sum_{i=1}^n \left(\frac{h_n}{h_i} \right)^2 \frac{A_i}{\left[1 + 0.83 \left(\frac{h_i}{L_i} \right)^2 \right]} \quad (5.2-9)$$

where:

A_B = the base area of the structure,

A_i = the area of shear wall i ,

L_i = the length of shear wall i ,

h_n = the height above the base to the highest level of the structure,

h_i = the height of shear wall i , and

n = the number of shear walls in the building effective in resisting lateral forces in the direction under consideration.

5.2.3 Vertical distribution of seismic forces. The lateral force, F_x , induced at any level shall be determined from the following equations:

$$F_x = C_{vx} V \quad (5.2-10)$$

and

$$C_{vx} = \frac{w_x h_x^k}{\sum_{i=1}^n w_i h_i^k} \quad (5.2-11)$$

where:

C_{vx} = vertical distribution factor,

V = total design lateral force or shear at the base of the structure,

w_i and w_x = the portion of the total gravity load of the structure, W , located or assigned to Level i or x ,

- h_i and h_x = the height from the base to Level i or x , and
- k = an exponent related to the effective fundamental period of the structure as follows:
- For structures having a period of 0.5 seconds or less, $k = 1$
- For structures having a period of 2.5 seconds or more, $k = 2$
- For structures having a period between 0.5 and 2.5 seconds, k shall be determined by linear interpolation between 1 and 2 or may be taken equal to 2.

5.2.4 Horizontal shear distribution. The seismic design story shear in any story, V_x , shall be determined from the following equation:

$$V_x = \sum_{i=x}^n F_i \quad (5.2-12)$$

where F_i = the portion of the seismic base shear, V , induced at Level i .

The seismic design story shear, V_x , shall be distributed to the various vertical elements of the seismic-force-resisting system in the story under consideration based on the relative lateral stiffnesses of the vertical resisting elements and the diaphragm.

5.2.4.1 Inherent torsion. The distribution of lateral forces at each level shall consider the effect of the inherent torsional moment, M_t , resulting from eccentricity between the locations of the center of mass and the center of rigidity.

5.2.4.2 Accidental torsion. In addition to the inherent torsional moment, the distribution of lateral forces also shall include accidental torsional moments, M_{ta} , caused by an assumed displacement of the mass each way from its actual location by a distance equal to 5 percent of the dimension of the structure perpendicular to the direction of the applied forces.

5.2.4.3 Dynamic amplification of torsion. For structures assigned to Seismic Design Category C, D, E, or F, where Type 1 torsional irregularity exists as defined in Table 4.3-2, the effects of torsional irregularity shall be accounted for by multiplying the sum of M_t plus M_{ta} at each level by a torsional amplification factor, A_x , determined from the following equation:

$$A_x = \left(\frac{\delta_{max}}{1.2\delta_{avg}} \right)^2 \quad (5.2-13)$$

where:

- δ_{max} = the maximum displacement at Level x , and
- δ_{avg} = the average of the displacements at the extreme points of the structure at Level x .

The torsional amplification factor, A_x , is not required to exceed 3.0. The more severe loading for each element shall be considered for design.

5.2.5 Overturning. The structure shall be designed to resist overturning effects caused by the seismic forces determined in Sec. 5.2.3. At any story, the increment of overturning moment in the story under consideration shall be distributed to the various vertical force resisting elements in the same proportion as the distribution of the horizontal shears to those elements.

The overturning moments at Level x , M_x , shall be determined from Eq. 5.2-14 as follows:

$$M_x = \sum_{i=x}^n F_i (h_i - h_x) \quad (5.2-14)$$

where:

- F_i = the portion of the seismic base shear, V , induced at Level i , and
 h_i and h_x = the height from the base to Level i or x .

The foundations of structures, except inverted pendulum-type structures, shall be permitted to be designed for three-fourths of the foundation overturning design moment, M_0 , determined using Eq. 5.2-14 at the foundation-soil interface.

5.2.6 Drift determination and P-delta limit. Story drifts shall be determined in accordance with this section. Determination of story drifts shall be based on the application of the design seismic forces to a mathematical model of the physical structure. The model shall include the stiffness and strength of all elements that are significant to the distribution of forces and deformations in the structure and shall represent the spatial distribution of the mass and stiffness of the structure. In addition, the model shall comply with the following:

1. Stiffness properties of reinforced concrete and masonry elements shall consider the effects of cracked sections and
2. For steel moment resisting frame systems, the contribution of panel zone deformations to overall story drift shall be included.

5.2.6.1 Story drift determination. The design story drift, Δ , shall be computed as the difference of the deflections at the center of mass at the top and bottom of the story under consideration.

Exception: For structures of Seismic Design Category C, D, E or F having plan irregularity Type 1a or 1b of Table 4.3-2, the design story drift, Δ , shall be computed as the largest difference of the deflections along any of the edges of the structure at the top and bottom of the story under consideration.

The deflections of Level x , δ_x , shall be determined in accordance with following equation:

$$\delta_x = \frac{C_d \delta_{xe}}{I} \quad (5.2-15)$$

where:

- C_d = the deflection amplification factor from Table 4.3-1,
 δ_{xe} = the deflections determined by an elastic analysis, and
 I = the occupancy importance factor determined in accordance with Sec. 1.3.

The elastic analysis of the seismic-force-resisting system shall be made using the prescribed seismic design forces of Sec. 5.2.3.

For determining compliance with the story drift limits of Sec. 4.5.1, it shall be permitted to determine the elastic drifts, δ_{xe} , using seismic design forces based on the computed fundamental period of the structure without the upper limit ($C_u T_u$) specified in Sec. 5.2.2.

Where nonlinear analysis is required by Sec. 5.2.6.2 and the nonlinear static procedure is used, the design story drift, Δ , shall be determined according to Sec. A5.2.4.

5.2.6.2 P-delta limit. stability coefficient, θ , as determined for each level of the structure by the following equation, shall not exceed 0.10:

$$\theta = \frac{P_x \Delta I}{V_x h_{sx} C_d} \quad (5.2-16)$$

where:

- P_x = the total vertical design load at and above Level x . Where calculating the vertical design load for purposes of determining P-delta effects, the individual load factors need not exceed 1.0.
- Δ = the design story drift calculated in accordance with Sec. 5.2.6.1.
- I = the occupancy importance factor determined in accordance with Sec.1.3
- V_x = the seismic shear force acting between Level x and $x - 1$.
- h_{sx} = the story height below Level x .
- C_d = the deflection amplification factor from Table 4.3-1.

Exception: The stability coefficient θ , shall be permitted to exceed 0.10 if the resistance to lateral forces is determined to increase continuously in a monotonic nonlinear static (pushover) analysis to the target displacement as determined in Sec. A5.2.3. P-delta effects shall be included in the analysis.

5.3 RESPONSE SPECTRUM PROCEDURE

A modal response spectrum analysis shall consist of the analysis of a linear mathematical model of the structure to determine the maximum accelerations, forces, and displacements resulting from the dynamic response to ground shaking represented by the design response spectrum. The analysis shall be performed in accordance with the requirements of this section. For purposes of analysis, the structure shall be permitted to be considered to be fixed at the base or, alternatively, it shall be permitted to use realistic assumptions with regard to the stiffness of foundations. The symbols used in this section have the same meaning as those for similar terms used in Sec. 5.2 but with the subscript m denoting quantities relating to the m^{th} mode.

5.3.1 Modeling. A mathematical model of the structure shall be constructed that represents the spatial distribution of mass and stiffness throughout the structure. For regular structures with independent orthogonal seismic-force-resisting systems, independent two-dimensional models are permitted to be constructed to represent each system. For irregular structures or structures without independent orthogonal systems, a three-dimensional model incorporating a minimum of three dynamic degrees of freedom consisting of translation in two orthogonal plan directions and torsional rotation about the vertical axis shall be included at each level of the structure. Where the diaphragms are not rigid compared to the vertical elements of the lateral-force-resisting system, the model should include representation of the diaphragm's flexibility and such additional dynamic degrees of freedom as are required to account for the participation of the diaphragm in the structure's dynamic response. In addition, the model shall comply with the following:

1. Stiffness properties of concrete and masonry elements shall consider the effects of cracked sections and
2. The contribution of panel zone deformations to overall story drift shall be included for steel moment frame resisting systems.

5.3.2 Modes. An analysis shall be conducted to determine the natural modes of vibration for the structure including the period of each mode, the modal shape vector ϕ , the modal participation factor, and modal mass. The analysis shall include a sufficient number of modes to obtain a combined modal mass participation of at least 90 percent of the actual mass in each of two orthogonal directions.

5.3.3 Modal properties. The required periods, mode shapes, and participation factors of the structure shall be calculated by established methods of structural analysis for the fixed-base condition using the masses and elastic stiffnesses of the seismic-force-resisting system.

5.3.4 Modal base shear. The portion of the base shear contributed by the m^{th} mode, V_m , shall be determined from the following equations:

$$V_m = C_{sm} \bar{W}_m \quad (5.3-1)$$

$$\bar{W}_m = \frac{\left(\sum_{i=1}^n w_i \phi_{im} \right)^2}{\sum_{i=1}^n w_i \phi_{im}^2} \quad (5.3-2)$$

where:

- C_{sm} = the modal seismic response coefficient as determined in this section,
- \bar{W}_m = the effective modal gravity load including portions of the live load as defined in Sec. 5.2.1,
- w_i = the portion of the total gravity load of the structure at Level i , and
- ϕ_{im} = the displacement amplitude at the i^{th} level of the structure where vibrating in its m^{th} mode.

The modal seismic response coefficient, C_{sm} , shall be determined in accordance with the following equation:

$$C_{sm} = \frac{S_{am}}{R/I} \quad (5.3-3)$$

where:

- S_{am} = The design spectral response acceleration at period T_m determined from either Sec. 3.3.4 or Sec. 3.4.4,
- R = the response modification factor determined from Table 4.3-1,
- I = the occupancy importance factor determined in accordance with Sec. 1.3, and
- T_m = the modal period of vibration (in seconds) of the m^{th} mode of the structure.

Exceptions:

1. Where the standard design response spectrum of Sec. 3.3.4 is used for structures on Site Class D, E or F soils, the modal seismic design coefficient, C_{sm} , for modes other than the fundamental mode that have periods less than 0.3 seconds is permitted to be determined by the following equation:

$$C_{sm} = \frac{0.4 S_{DS}}{R/I} (1 + 5T_m) \quad (5.3-4)$$

where S_{DS} is as defined in Sec. 3.3.3 and R , I , and T_m are as defined above.

2. Where the standard design response spectrum of Sec. 3.3.4 is used for structures where any modal period of vibration, T_m , exceeds T_L , the modal seismic design coefficient, C_{sm} , for that mode is permitted to be determined by the following equation:

$$C_{sm} = \frac{S_{DI} T_L}{(R/I) T_m^2} \quad (5.3-5)$$

where R , I , and T_m are as defined above and S_{DI} is the design spectral response acceleration parameter at a period of 1 second as determined in Sec. 3.3.3. and T_L is the Long-period transition period as defined in Sec. 3.3.4.

The reduction due to soil-structure interaction as determined in Sec. 5.6.3 shall be permitted to be used.

5.3.5 Modal forces, deflections, and drifts. The modal force, F_{xm} , at each level shall be determined by the following equations:

$$F_{xm} = C_{vsm} V_m \quad (5.3-6)$$

and

$$C_{vsm} = \frac{w_x \phi_{xm}}{\sum_{i=1}^n w_i \phi_{im}} \quad (5.3-7)$$

where:

- C_{vsm} = the vertical distribution factor in the m^{th} mode,
- V_m = the total design lateral force or shear at the base in the m^{th} mode,
- w_i, w_x = the portion of the total gravity load, W , located or assigned to Level i or x ,
- ϕ_{xm} = the displacement amplitude at the x^{th} level of the structure where vibrating in its m^{th} mode, and
- ϕ_{im} = the displacement amplitude at the i^{th} level of the structure where vibrating in its m^{th} mode.

The modal deflection at each level, δ_{xm} , shall be determined by the following equations:

$$\delta_{xm} = \frac{C_d \delta_{xem}}{I} \quad (5.3-8)$$

and

$$\delta_{xem} = \left(\frac{g}{4\pi^2} \right) \left(\frac{T_m^2 F_{xm}}{w_x} \right) \quad (5.3-9)$$

where:

- C_d = the deflection amplification factor determined from Table 4.3-1,
- δ_{xem} = the deflection of Level x in the m^{th} mode at the center of the mass at Level x determined by an elastic analysis,
- g = the acceleration due to gravity,
- I = the occupancy importance factor determined in accordance with Sec. 1.3,
- T_m = the modal period of vibration, in seconds, of the m^{th} mode of the structure,
- F_{xm} = the portion of the seismic base shear in the m^{th} mode, induced at Level x , and
- w_x = the portion of the total gravity load of the structure, W , located or assigned to Level x .

The modal drift in a story, Δ_m , shall be computed as the difference of the deflections, δ_{xm} , at the top and bottom of the story under consideration.

5.3.6 Modal story shears and moments. The story shears, story overturning moments, and the shear forces and overturning moments in vertical elements of the structural system at each level due to the seismic forces determined from the appropriate equation in Sec. 5.3.5 shall be computed for each mode by linear static methods.

5.3.7 Design values. The design value for the modal base shear, V_i ; each of the story shear, moment, and drift quantities; and the deflection at each level shall be determined by combining their modal

values as obtained from Sec. 5.3.5 and 5.3.6. The combination shall be carried out by taking the square root of the sum of the squares of each of the modal values or by the complete quadratic combination technique. The complete quadratic combination shall be used where closely spaced periods in the translational and torsional modes will result in cross-correlation of the modes.

A base shear, V , shall be calculated using the equivalent lateral force procedure in Sec. 5.2. For the purpose of this calculation, the fundamental period of the structure, T , in seconds, shall not exceed the coefficient for upper limit on the calculated period, C_u , times the approximate fundamental period of the structure, T_a . Where the design value for the modal base shear, V_i , is less than 85 percent of the calculated base shear, V , using the equivalent lateral force procedure, the design story shears, moments, drifts, and floor deflections shall be multiplied by the following modification factor:

$$0.85 \frac{V}{V_i} \quad (5.3-10)$$

where:

V = the equivalent lateral force procedure base shear calculated in accordance with this section and Sec. 5.2 and

V_i = the modal base shear calculated in accordance with this section.

Where soil-structure interaction is considered in accordance with Sec. 5.6, the value of V may be taken as the reduced value of V .

5.3.8 Horizontal shear distribution. The distribution of horizontal shear shall be in accordance with the requirements of Sec. 5.2.4 except that amplification of torsion per Sec. 5.2.4.3 is not required for that portion of the torsion included in the dynamic analysis model.

5.3.9 Foundation overturning. The foundation overturning moment at the foundation-soil interface shall be permitted to be reduced by 10 percent.

5.3.10 P-delta effects. The P-delta effects shall be determined in accordance with Sec. 5.2.6. The story drifts and story shears shall be determined in accordance with Sec. 5.2.6.1.

5.4 LINEAR RESPONSE HISTORY PROCEDURE

A linear response history analysis shall consist of an analysis of a linear mathematical model of the structure to determine its response, through methods of numerical integration, to suites of ground motion acceleration histories compatible with the design response spectrum for the site. The analysis shall be performed in accordance with the provisions of this section. For the purposes of analysis, the structure shall be permitted to be considered to be fixed at the base or, alternatively, it shall be permitted to use realistic assumptions with regard to the stiffness of foundations.

5.4.1 Modeling. Mathematical models shall conform to the requirements of Sec. 5.3.1.

5.4.2 Ground motion. A suite of not fewer than three appropriate ground motions shall be used in the analysis. Ground motion shall conform to the requirements of this section.

5.4.2.1 Two-dimensional analysis. Where two-dimensional analyses are performed, each ground motion shall consist of a horizontal acceleration history selected from an actual recorded event. Appropriate acceleration histories shall be obtained from records of events having magnitudes, fault distance, and source mechanisms that are consistent with those that control the maximum considered earthquake. Where the required number of appropriate recorded ground motion records are not available, appropriate simulated ground motion records shall be used to make up the total number required. The ground motions shall be scaled such that for each period between $0.2T$ and $1.5T$ (where T is the natural period of the structure in the fundamental mode for the direction of response being analyzed) the average of the five-percent-damped response spectra for the suite of motions is not less

than the corresponding ordinate of the design response spectrum, determined in accordance with Sec. 3.3.4 or 3.4.4.

5.4.2.2 Three-dimensional analysis. Where three-dimensional analysis is performed, ground motions shall consist of pairs of appropriate horizontal ground motion acceleration components that shall be selected and scaled from individual recorded events. Appropriate ground motions shall be selected from events having magnitudes, fault distance, and source mechanisms that are consistent with those that control the maximum considered earthquake. Where the required number of recorded ground motion pairs are not available, appropriate simulated ground motion pairs shall be used to make up the total number required. For each pair of horizontal ground motion components, an SRSS spectrum shall be constructed by taking the square root of the sum of the squares of the five-percent-damped response spectra for the components (where an identical scale factor is applied to both components of a pair). Each pair of motions shall be scaled such that for each period between $0.2T$ and $1.5T$ (where T is the natural period of the fundamental mode of the structure) the average of the SRSS spectra from all horizontal component pairs is not less than 1.3 times the corresponding ordinate of the design response spectrum, determined in accordance with Sec. 3.3.4 or 3.4.4.

5.4.3 Response parameters. For each ground motion analyzed, the individual response parameters shall be scaled by the quantity I/R where I is the occupancy importance factor determined in accordance with Sec. 1.3 and R is the response modification coefficient selected in accordance with Sec. 4.3-1. The maximum value of the base shear, V_i , member forces, Q_{Ei} , and the interstory drifts, δ_i , at each story scaled as indicated above shall be determined. Where the maximum scaled base shear predicted by the analysis, V_i , is less than that given by Eq. 5.2-4 or, in Seismic Design Categories E and F, Eq. 5.2-5, the scaled member forces, Q_{Ei} , shall be additionally scaled by the factor V/V_i where V is the minimum base shear determined in accordance with Eq. 5.2-4 or, for structures in Seismic Design Category E or F, Eq. 5.2-5.

If at least seven ground motions are analyzed, the design member forces, Q_E , used in the load combinations of Sec. 4.2.2 and the design interstory drift, Δ , used in the evaluation of drift in accordance with Sec. 4.5.1 shall be permitted to be taken, respectively, as the average of the scaled Q_{Ei} and δ_i values determined from the analyses and scaled as indicated above. If fewer than seven ground motions are analyzed, the design member forces, Q_E , and the design interstory drift, Δ , shall be taken as the maximum value of the scaled Q_{Ei} and δ_i values determined from the analyses.

Where these *Provisions* require the consideration of the seismic load effect with overstrength as defined in Sec. 4.2.2.2, the value of $\Omega_0 Q_E$ need not be taken larger than the maximum of the unscaled value, Q_{Ei} , obtained from the suite of analyses.

5.5 NONLINEAR RESPONSE HISTORY PROCEDURE

A nonlinear response history analysis shall consist of an analysis of a mathematical model of the structure that directly accounts for the nonlinear hysteretic behavior of the structure's components to determine its response, through methods of numerical integration, to suites of ground motion acceleration histories compatible with the design response spectrum for the site. The analysis shall be performed in accordance with the requirements of this section.

5.5.1 Modeling. A mathematical model of the structure shall be constructed that represents the spatial distribution of mass throughout the structure. The hysteretic behavior of elements shall be modeled consistent with suitable laboratory test data and shall account for all significant yielding, strength degradation, stiffness degradation, and hysteretic pinching indicated by such test data. Strength of elements shall be based on expected values considering material overstrength, strain hardening, and hysteretic strength degradation. Linear properties, consistent with the provisions of Section 5.3.1 shall be permitted to be used for those elements demonstrated by the analysis to remain within their linear range of response. The structure shall be assumed to have a fixed base or, alternatively, it shall be

permitted to use realistic assumptions with regard to the stiffness and load carrying characteristics of the foundations consistent with site-specific soils data and rational principles of engineering mechanics.

For regular structures with independent orthogonal seismic-force-resisting systems, independent two-dimensional models shall be permitted to be constructed to represent each system. For structures having plan irregularity Type 1a, 1b, 4, or 5 of Table 4.3-2 or structures without independent orthogonal systems, a three-dimensional model incorporating a minimum of three dynamic degrees of freedom consisting of translation in two orthogonal plan directions and torsional rotation about the vertical axis at each level of the structure shall be used. Where the diaphragms are not rigid compared to the vertical elements of the lateral-force-resisting system, the model shall include representation of the diaphragm's flexibility and such additional dynamic degrees of freedom as are required to account for the participation of the diaphragm in the structure's dynamic response.

5.5.2 Ground motion and other loading. Ground motion shall conform to the requirements of Sec. 5.4.2. The structure shall be analyzed for the effects of these ground motions simultaneously with the effects of dead load in combination with not less than 25 percent of the required live loads.

5.5.3 Response parameters. For each ground motion analyzed, individual response parameters consisting of the maximum value of the individual member forces, Q_{Ei} , member inelastic deformations, γ_i , and story drifts, Δ_i , shall be determined.

If at least seven ground motions are analyzed, the design values of member forces, Q_E , member inelastic deformations, γ , and story drift, Δ , shall be permitted to be taken, respectively, as the average of the scaled Q_{Ei} , γ_i , and Δ_i values determined from the analyses. If fewer than seven ground motions are analyzed, the design member forces, Q_E , design member inelastic deformations, γ , and the design story drift, Δ , shall be taken as the maximum value of the scaled Q_{Ei} , γ_i , and Δ_i values determined from the analyses.

5.5.3.1 Member strength. The adequacy of members to resist the load combinations of Sec 4.2.2 need not be evaluated.

Exception: Where the *Provisions* require the consideration of the seismic load effect with overstrength, determined in accordance with Sec. 4.2.2.2, the maximum value of Q_{Ei} obtained from the suite of analyses shall be taken in place of the quantity $\Omega_0 Q_E$.

5.5.3.2 Member deformation. The adequacy of individual members and their connections to withstand the design deformations, γ , predicted by the analyses shall be evaluated based on laboratory test data for similar components. The effects of gravity and other loads on member deformation capacity shall be considered in these evaluations. Member deformation shall not exceed two thirds of the lesser of: the value that results in loss of ability to carry gravity loads or the value at which member strength has deteriorated to less than the 67 percent of the peak strength.

5.5.3.3 Story drift. The design story drifts, Δ , obtained from the analyses shall not exceed 125 percent of the drift limit specified in Sec. 4.5.1.

5.5.4 Design review. A review of the design of the seismic-force-resisting system and the supporting structural analyses shall be performed by an independent team consisting of registered design professionals in the appropriate disciplines and others with experience in seismic analysis methods and the theory and application of nonlinear seismic analysis and structural behavior under extreme cyclic loads. The design review shall include, but need not be limited to, the following:

1. Review of any site-specific seismic criteria employed in the analysis including the development of site-specific spectra and ground motion time histories,
2. Review of acceptance criteria used to demonstrate the adequacy of structural elements and systems to withstand the calculated force and deformation demands, together with laboratory and other data used to substantiate such criteria,

3. Review of the preliminary design including the determination of the target displacement of the structure and the margins remaining beyond these displacements, and
4. Review of the final design of the entire structural system and all supporting analyses.

5.6 SOIL-STRUCTURE INTERACTION EFFECTS

5.6.1 General. The requirements set forth in this section are permitted to be used to incorporate the effects of soil-structure interaction in the determination of the design earthquake forces and the corresponding displacements of the structure when the model used for structural response analysis does not directly incorporate the effects of foundation flexibility (i.e., the model corresponds to a fixed-base condition with no foundation springs). The use of these requirements will decrease the design values of the base shear, lateral forces, and overturning moments but may increase the computed values of the lateral displacements and the secondary forces associated with the P-delta effects.

The requirements for use with the equivalent lateral force procedure are given in Sec. 5.6.2 and those for use with the response spectrum procedure are given in Sec. 5.6.3. The provisions in Sec. 5.6 shall not be used if a flexible-base, rather than a fixed base, foundation is directly modeled in the structural response analysis.

5.6.2 Equivalent lateral force procedure. The following requirements are supplementary to those presented in Sec. 5.2.

5.6.2.1 Base shear. To account for the effects of soil-structure interaction, the base shear, V , determined from Eq. 5.2-1 may be reduced to:

$$\tilde{V} = V - \Delta V \quad (5.6-1)$$

where the reduction, ΔV , shall be computed as follows:

$$\Delta V = \left[C_s - \tilde{C}_s \left(\frac{0.05}{\tilde{\beta}} \right)^{0.4} \right] \bar{W} \quad (5.6-2)$$

where:

- C_s = the seismic response coefficient computed from Eq. 5.2-2 using the fundamental natural period of the fixed-base structure as specified in Sec. 5.2.2,
- \tilde{C}_s = the seismic response coefficient computed from Eq. 5.2-2 using the effective period of the flexibly supported structure defined in Sec. 5.6.2.1.1,
- $\tilde{\beta}$ = the fraction of critical damping for the structure-foundation system determined in Sec. 5.6.2.1.2, and
- \bar{W} = the effective gravity load of the structure, which shall be taken as $0.7W$, except that for structures where the gravity load is concentrated at a single level, it shall be taken equal to W .

The reduced base shear, \tilde{V} , shall in no case be taken less than $0.7V$.

5.6.2.1.1 Effective building period. The effective period of the flexibly supported structure, \tilde{T} , shall be determined as follows:

$$\tilde{T} = T \sqrt{1 + \frac{\bar{k}}{K_y} \left(1 + \frac{K_y \bar{h}^2}{K_\theta} \right)} \quad (5.6-3)$$

where:

T = the fundamental period of the structure as determined in Sec. 5.2.2;

\bar{k} = the stiffness of the fixed-base structure, defined by the following:

$$\bar{k} = 4\pi^2 \left(\frac{\bar{W}}{gT^2} \right) \quad (5.6-4)$$

\bar{h} = the effective height of the structure which shall be taken as 0.7 times the total height, h_n , except that for structures where the gravity load is effectively concentrated at a single level, it shall be taken as the height to that level;

K_y = the lateral stiffness of the foundation defined as the horizontal force at the level of the foundation necessary to produce a unit deflection at that level, the force and the deflection being measured in the direction in which the structure is analyzed;

K_θ = the rocking stiffness of the foundation defined as the moment necessary to produce a unit average rotation of the foundation, the moment and rotation being measured in the direction in which the structure is analyzed; and

g = the acceleration due to gravity.

The foundation stiffnesses, K_y and K_θ , shall be computed by established principles of foundation mechanics (see the *Commentary*) using soil properties that are compatible with the soil strain levels associated with the design earthquake motion. The average shear modulus, G , for the soils beneath the foundation at large strain levels and the associated shear wave velocity, v_s , needed in these computations shall be determined from Table 5.6-1 where:

v_{so} = the average shear wave velocity for the soils beneath the foundation at small strain levels (10^{-3} percent or less),

$G_o = \gamma v_{so}^2 / g$ = the average shear modulus for the soils beneath the foundation at small strain levels, and

γ = the average unit weight of the soils.

Table 5.6-1 Values of G/G_o and v_s/v_{so}

	$S_{DS}/2.5$			
	≤ 0.10	0.15	0.20	≥ 0.30
Value of G/G_o	0.81	0.64	0.49	0.42
Value of v_s/v_{so}	0.90	0.80	0.70	0.65

Alternatively, for structures supported on mat foundations that rest at or near the ground surface or are embedded in such a way that the side wall contact with the soil cannot be considered to remain effective during the design ground motion, the effective period of the structure may be determined from:

$$\tilde{T} = T \sqrt{1 + \frac{25\alpha}{v_s^2 T^2} \frac{r_a \bar{h}}{\alpha_\theta r_m^3} \left(1 + \frac{1.12 r_a \bar{h}^2}{\alpha_\theta r_m^3} \right)} \quad (5.6-5)$$

where:

α = the relative weight density of the structure and the soil, defined by:

$$\alpha = \frac{\bar{W}}{\gamma A_o \bar{h}} \quad (5.6-6)$$

r_a and r_m = characteristic foundation lengths, defined by:

$$r_a = \sqrt{\frac{A_o}{\pi}} \quad (5.6-7)$$

and

$$r_m = \sqrt[4]{\frac{4I_o}{\pi}} \quad (5.6-8)$$

where:

A_o = the area of the foundation,

I_o = the static moment of the foundation about a horizontal centroidal axis normal to the direction in which the structure is analyzed, and

α_θ = dynamic foundation stiffness modifier for rocking (see *Commentary*).

5.6.2.1.2 Effective damping. The effective damping factor for the structure-foundation system, $\tilde{\beta}$, shall be computed as follows:

$$\tilde{\beta} = \beta_o + \frac{0.05}{\left(\frac{\tilde{T}}{T}\right)^3} \quad (5.6-9)$$

where β_o = the foundation damping factor as specified in Figure 5.6-1.

For values of $S_{DS}/2.5$ between 0.10 and 0.20, values of β_o shall be determined by linear interpolation between the solid lines and the dashed lines of Figure 5.6-1.

The quantity r in Figure 5.6-1 is a characteristic foundation length that shall be determined as follows:

$$\text{For } \frac{\bar{h}}{L_o} \leq 0.5, r = r_a$$

$$\text{For } \frac{\bar{h}}{L_o} \geq 1.0, r = r_m$$

For intermediate values of $\frac{\bar{h}}{L_o}$, r shall be determined by linear interpolation.

where:

L_o = the overall length of the side of the foundation in the direction being analyzed, and

r_a and r_m = characteristic foundation lengths, defined in Sec. 5.6.2.1.1.

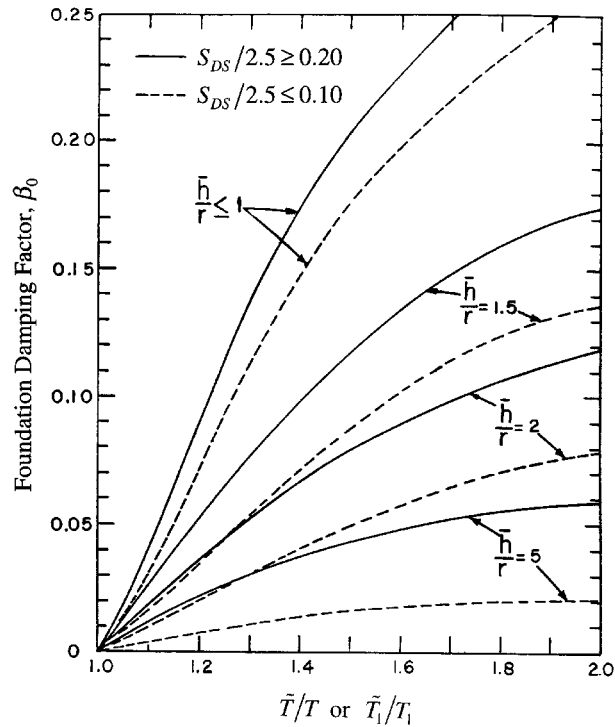

Figure 5.6-1 Foundation Damping Factor

Exception: For structures supported on point bearing piles and in all other cases where the foundation soil consists of a soft stratum of reasonably uniform properties underlain by a much stiffer, rock-like deposit with an abrupt increase in stiffness, the factor β_o in Eq. 5.6-9 shall be replaced by:

$$\beta'_o = \left(\frac{4D_s}{v_s \tilde{T}} \right)^2 \beta_o \quad (5.6-10)$$

if $\frac{4D_s}{v_s \tilde{T}} < 1$, where D_s is the total depth of the stratum.

The value of $\tilde{\beta}$ computed from Eq. 5.6-9, with or without the adjustment represented by Eq. 5.6-10, shall in no case be taken less than 0.05 or greater than 0.20.

5.6.2.2 Vertical distribution of seismic forces. The distribution over the height of the structure of the reduced total seismic force, \tilde{V} , shall be considered to be the same as for the fixed-base structure.

5.6.2.3 Other effects. The modified story shears, overturning moments, and torsional effects about a vertical axis shall be determined as for structures without interaction using the reduced lateral forces.

The modified deflections, $\tilde{\delta}_x$, shall be determined as follows:

$$\tilde{\delta}_x = \frac{\tilde{V}}{V} \left(\frac{M_o h_x}{K_\theta} + \delta_x \right) \quad (5.6-11)$$

where:

- M_o = the overturning moment at the base determined in accordance with Sec. 5.2.5 using the unmodified seismic forces and not including the reduction permitted in the design of the foundation,
- h_x = the height above the base to the level under consideration, and
- δ_x = the deflections of the fixed-base structure as determined in Sec. 5.2.6.1 using the unmodified seismic forces.

The modified story drifts and P-delta effects shall be evaluated in accordance with the requirements of Sec. 5.2.6 using the modified story shears and deflections determined in this section.

5.6.3 Response spectrum procedure. The following requirements are supplementary to those presented in Sec. 5.3.

5.6.3.1 Modal base shears. To account for the effects of soil-structure interaction, the base shear corresponding to the fundamental mode of vibration, V_1 , is permitted to be reduced to:

$$\tilde{V}_1 = V_1 - \Delta V_1 \quad (5.6-12)$$

The reduction, ΔV_1 , shall be computed in accordance with Eq. 5.6-2 with \bar{W} taken as equal to the gravity load \bar{W}_1 defined by Eq. 5.3-2, C_s computed from Eq. 5.3-3 using the fundamental period of the fixed-base structure, T_1 , and \tilde{C}_s computed from Eq. 5.3-3 using the fundamental period of the flexibly supported structure, \tilde{T}_1 .

The period \tilde{T}_1 shall be determined from Eq. 5.6-3, or from Eq. 5.6-5 where applicable, taking $T = \tilde{T}_1$, evaluating \bar{k} from Eq. 5.6-4 with $\bar{W} = \bar{W}_1$, and computing \bar{h} as follows:

$$\bar{h} = \frac{\sum_{i=1}^n w_i \phi_{i1} h_i}{\sum_{i=1}^n w_i \phi_{i1}} \quad (5.6-13)$$

The above designated values of \bar{W} , \bar{h} , T , and \tilde{T} also shall be used to evaluate the factor α from Eq. 5.6-6 and the factor β_o from Figure 5.6-1. No reduction shall be made in the shear components contributed by the higher modes of vibration. The reduced base shear, \tilde{V}_1 , shall in no case be taken less than $0.7V_1$.

5.6.3.2 Other modal effects. The modified modal seismic forces, story shears, and overturning moments shall be determined as for structures without interaction using the modified base shear, \tilde{V}_1 , instead of V_1 . The modified modal deflections, $\tilde{\delta}_{xm}$, shall be determined as follows:

$$\tilde{\delta}_{x1} = \frac{\tilde{V}_1}{V_1} \left(\frac{M_o h_x}{K_\theta} + \delta_{x1} \right) \quad (5.6-14)$$

and

$$\tilde{\delta}_{xm} = \delta_{xm} \text{ for } m = 2, 3, \dots \quad (5.6-15)$$

where:

- M_{o1} = the overturning base moment for the fundamental mode of the fixed-base structure, as determined in Sec. 5.3.6 using the unmodified modal base shear V_1 , and

δ_{xm} = the modal deflections at Level x of the fixed-base structure as determined in Sec. 5.3.5 using the unmodified modal shears, V_m .

The modified modal drift in a story, $\tilde{\Delta}_m$, shall be computed as the difference of the deflections, $\tilde{\delta}_{xm}$, at the top and bottom of the story under consideration.

5.6.3.3 Design values The design values of the modified shears, moments, deflections, and story drifts shall be determined as for structures without interaction by taking the square root of the sum of the squares of the respective modal contributions. In the design of the foundation, the overturning moment at the foundation-soil interface determined in this manner may be reduced by 10 percent as for structures without interaction.

The effects of torsion about a vertical axis shall be evaluated in accordance with the requirements of Sec. 5.2.4 and the P-delta effects shall be evaluated in accordance with the requirements of Sec. 5.2.6.1, using the story shears and drifts determined in Sec. 5.6.3.2.

This page is intentionally left blank.

Appendix to Chapter 5

NONLINEAR STATIC PROCEDURE

PREFACE: This appendix addresses nonlinear static analysis, a seismic analysis procedure also sometimes known as pushover analysis, for review and comment and for adoption into a subsequent edition of the *Provisions*.

Although nonlinear static analysis has only recently been included in design provisions for new building construction, the procedure itself is not new and has been used for many years in both research and design applications. For example, nonlinear static analysis has been used for many years as a standard methodology in the design of the offshore platform structures for hydrodynamic effects and has been adopted recently in several standard methodologies for the seismic evaluation and -rehabilitation of building structures, including the *Recommended Seismic Design Criteria for New Steel Moment-Frame Buildings* (FEMA-350, 2000a), *Prestandard and Commentary for the Seismic Rehabilitation of Buildings* (FEMA 356, 2000b) and *Seismic Evaluation and Retrofit of Concrete Buildings* (ATC 40, 1996). Nonlinear static analysis forms the basis for earthquake loss estimation procedures contained in *HAZUS* (NIBS, 1999), FEMA's nationally applicable earthquake loss estimation model. Although it does not explicitly appear in the *Provisions*, the nonlinear static analysis methodology also forms the basis for the equivalent lateral force procedures contained in the provisions for base-isolated structures and structures with dampers.

One of the controversies surrounding the introduction of this methodology into the *Provisions* relates to the determination of the limit deformation (sometimes called a target displacement). Several methodologies for estimating the amount of deformation induced in a structure by earthquake-induced ground shaking have been proposed and are included in various adoptions of the procedure. The approach presented in this appendix is based on statistical correlations of the displacements predicted by linear and nonlinear dynamic analyses of structures, which is similar to that contained in FEMA 356.

A second controversy relates to the limited availability of consensus-based acceptance criteria to be used to determine the adequacy of a design once the forces and deformations produced by design earthquake ground shaking are estimated. It should be noted that this limitation applies equally to the nonlinear response history approach, which already has been adopted into building codes.

Nonlinear static analysis provides a simplified method of directly evaluating nonlinear response of structures to strong earthquake ground shaking that can be an attractive alternative to the more complex procedures of nonlinear response history analysis. It is hoped that exposure of this approach

through inclusion in this appendix will allow the necessary consensus to be developed to permit later integration into the *Provisions* as such.

Users of this appendix also should consult the *Commentary* for guidance. Please direct all feedback on this appendix and its commentary to the BSSC.

A5.1 GENERAL

A5.1.1 Scope. This appendix provides guidelines for the use of the nonlinear static procedure for the analysis and design of structures.

A5.1.2 Definitions

Base: See Sec. 4.1.3.

Base shear: See Sec. 4.1.3.

Building: See Sec. 4.1.3.

Capacity curve: A plot of the total applied lateral force, V_j , versus the lateral displacement of the control point, δ_j , as determined in a nonlinear static analysis.

Component: See Sec. 1.1.4.

Control point: A point used to index the lateral displacement of the structure in a nonlinear static analysis, determined according to Sec. 5.2.1.

Dead load: See Sec. 4.1.3.

Design earthquake ground motion: See Sec. 1.1.4.

Diaphragm: See Sec. 4.1.3.

Effective Yield Displacement: The displacement of the control point at the intersection of the first and second branches of a bilinear curve that is fitted to the capacity curve according to Sec. A5.2.3.

Effective Yield Strength: The total applied lateral force at the intersection of the first and second branches of a bilinear curve that is fitted to the capacity curve according to Sec. A5.2.3.

Live load: See Sec. 4.1.3.

Registered design professional: See Sec. 2.1.3.

Seismic-force-resisting system: See Sec. 1.1.4.

Story: See Sec. 4.1.3.

Structure: See Sec. 1.1.4.

Target displacement: An estimate of the maximum expected displacement of the control point calculated for the design earthquake ground motion.

A5.1.3 Notation

C_d See Sec. 4.1.4.

C_s See Sec. 5.1.3

C_0 A modification factor to relate the displacement of the control point to the displacement of a representative single-degree-of-freedom system, as determined by Eq. A5.2-3.

C_I A modification factor to account for the influence of inelastic behavior on the response of the system, as determined by Eq. A5.2-4.

g acceleration of gravity.

j The increment of lateral loading.

Q_E See Sec. 4.1.4.

Q_{Ei} individual member forces, determined according to Sec. A5.2.9.1

R See Sec. 4.1.4.

R_d The system ductility factor as determined by Eq. A5.2.-5.

S_a See Sec. 3.1.4.

T_I The fundamental period of the structure in the direction under consideration.

T_e The effective fundamental period of the structure in the direction under consideration, as determined according to Sec. A5.2.3.

T_S See Sec. 3.1.4.

V_j	The total applied lateral force at load increment j .
V_I	The total applied lateral force at the first increment of lateral load.
V_y	The effective yield strength determined from a bilinear curve fitted to the capacity curve according to Sec. A5.2.3.
W	See Sec. 1.1.5.
w_i	See Sec. 4.1.4.
Δ	The design story drift as determined in Sec. A5.2.6.
γ_i	The deformations for member i .
δ_j	The displacement of the control point at load increment j .
δ_T	The target displacement of the control point, determined according to Sec. A5.2.5.
δ_I	The displacement of the control point at the first increment of lateral load.
δ_y	The effective yield displacement of the control point determined from a bilinear curve fitted to the capacity curve according to Sec. A5.2.3.
ϕ	The amplitude of the shape vector at Level i , determined according to Sec. A5.2.4.
Ω_0	See Sec. 4.1.4.

A5.2 NONLINEAR STATIC PROCEDURE

Where the nonlinear static procedure is used to design structures, the requirements of this section shall apply.

A5.2.1 Modeling. A mathematical model of the structure shall be constructed to represent the spatial distribution of mass and stiffness of the structural system considering the effects of component nonlinearity for deformation levels that exceed the proportional limit. P-Delta effects shall be included in the analysis.

For regular structures with independent orthogonal seismic-force-resisting systems, independent two-dimensional models shall be permitted to be used to represent each system. For structures having plan irregularities Types 4 and 5 as defined in Table 4.3-2 or structures without independent orthogonal systems, a three-dimensional model incorporating a minimum of three degrees of freedom for each level of the structure, consisting of translation in two orthogonal plan directions and torsional rotation about the vertical axis, shall be used. Where the diaphragms are not rigid compared to the vertical elements of the seismic-force-resisting system, the model should include representation of the diaphragm flexibility.

Unless analysis indicates that a component remains elastic, a nonlinear force deformation model shall be used to represent the stiffness of the component before onset of yield, the yield strength, and the stiffness properties of the component after yield at various levels of deformation. The properties of nonlinear component models shall be consistent with principles of mechanics or laboratory data. Properties representing component behavior before yield shall be consistent with the provisions of Sec. 5.3.1. Strengths of elements shall not exceed expected values considering material overstrength and strain hardening. The properties of elements and components after yielding shall account for strength and stiffness degradation due to softening, buckling, or fracture as indicated by principles of mechanics or test data. The model for columns should reflect the influence of axial load where axial loads exceed 15 percent of the compression strength. The structure shall be assumed to have a fixed base or, alternatively, it shall be permitted to use realistic assumptions with regard to the stiffness and load-carrying characteristics of the foundations, consistent with site-specific soil data and rational principles of engineering mechanics.

A control point shall be selected for each model. For structures without penthouses, the control point shall be at the center of mass of the highest level of the structure. For structures with penthouses, the control point shall be at the center of mass of the level at the base of the penthouse.

A5.2.2 Analysis. The structure shall be analyzed for seismic actions occurring simultaneously with the effects of dead load in combination with not less than 25 percent of the required design live loads, reduced as permitted for the area of a single floor. The lateral forces shall be applied at the center of mass of each level and shall be proportional to the distribution obtained from a modal analysis for the fundamental mode of response in the direction under consideration. The lateral loads shall be increased incrementally in a monotonic manner.

At the j -th increment of lateral loading, the total lateral force applied to the model shall be characterized by the term V_j . The incremental increases in applied lateral force should be in steps that are sufficiently small to permit significant changes in individual component behavior (such as yielding, buckling or failure) to be detected. The first increment in lateral loading shall result in linear elastic behavior. At each analysis step, the total applied lateral force, V_j , the lateral displacement of the control point, δ_j , and the forces and deformations in each component shall be recorded. The analysis shall be continued until the displacement of the control point is at least 150 percent of the target displacement determined in accordance with Sec. A5.2.5. The structure shall be designed so that the total applied lateral force does not decrease in any analysis increment for control point displacements less than or equal to 125 percent of the target displacement.

A5.2.3 Effective yield strength and effective period. A bilinear curve shall be fitted to the capacity curve, such that the first segment of the bilinear curve coincides with the capacity curve at 60 percent of the effective yield strength, the second segment coincides with the capacity curve at the target displacement, and the area under the bilinear curve equals the area under the capacity curve, between the origin and the target displacement. The effective yield strength, V_y , corresponds to the total applied lateral force at the intersection of the two line segments. The effective yield displacement, δ_y , corresponds to the control point displacement at the intersection of the two line segments.

The effective fundamental period, T_e , shall be determined using Eq. A5.2-1 as follows:

$$T_e = T_1 \sqrt{\frac{V_1 / \delta_1}{V_y / \delta_y}} \quad (\text{A5.2-1})$$

where V_1 , δ_1 , and T_1 are determined for the first increment of lateral load.

A5.2.4 Shape vector. The shape vector shall be equal to the first mode shape of the structure in the direction under consideration, determined by a modal analysis of the structure at the first increment of lateral load, and normalized to have unit amplitude at the level of the control point. It shall be permitted to substitute the deflected shape of the structure at the step at which the control point displacement is equal to the effective yield displacement in place of the mode shape, for determination of the shape vector.

A5.2.5 Target displacement. The target displacement of the control point, δ_T , shall be determined using Equation A5.2-2 as follows:

$$\delta_T = C_0 C_1 S_a \left(\frac{T_e}{2\pi} \right)^2 g \quad (\text{A5.2-2})$$

where the spectral acceleration, S_a , is determined from either Sec. 3.3.4 or Sec. 3.4.4 at the effective fundamental period, T_e , g is the acceleration of gravity, and the coefficients C_0 and C_1 are determined as follows.

The coefficient C_0 shall be calculated using Equation A5.2-3 as:

$$C_0 = \frac{\sum_{i=1}^n w_i \phi_i}{\sum_{i=1}^n w_i \phi_i^2} \quad (\text{A5.2-3})$$

where:

w_i = the portion of the seismic weight, W , at Level i , and

ϕ_i = the amplitude of the shape vector at Level i .

Where the effective fundamental period of the structure in the direction under consideration, T_e , is greater than T_s , as defined in Sec. 3.3.4 or Sec. 3.4.4, the coefficient C_1 shall be taken as 1.0. Otherwise, the value of the coefficient C_1 shall be calculated using Eq. A5.2-4 as follows:

$$C_1 = \frac{1}{R_d} \left(1 + \frac{(R_d - 1)T_s}{T_e} \right) \quad (\text{A5.2-4})$$

where R_d is given by Eq. A5.2-5 as follows:

$$R_d = \frac{S_a}{V_y / W} \quad (\text{A5.2-5})$$

and T_s and V_y are defined above, S_a is the design spectral acceleration at the effective fundamental period, T_e , and W is defined in Sec. 5.2.

A5.2.6 Story drift. The design story drift, Δ , taken as the value obtained for each story at the step at which the target displacement is reached shall not exceed the drift limit specified in Sec. 4.5.1 multiplied by $0.85R/C_d$.

A5.2.7 Member strength. In addition to satisfying the requirements of this Appendix, member strengths also shall satisfy the requirements of Sec. 4.2.2 using $E = 0$, except that Section 4.2.2.2 shall apply where these *Provisions* specifically require the consideration of structural overstrength on the design seismic force.

Where these *Provisions* require the consideration of structural overstrength according to Sec. 4.2.2.2, the value of the individual member forces, Q_{Ei} obtained from the analysis at the target displacement shall be taken in place of the quantity $\Omega_0 Q_E$.

A5.2.8 Distribution of design seismic forces. The lateral forces used for design of the members shall be applied at the center of mass of each level and shall be proportional to the distribution obtained from a modal analysis for the fundamental mode of response in the direction under consideration.

A5.2.9 Detailed evaluation. Sec. A5.2.9.1 and Sec. A5.2.9.2 need not be satisfied if the effective yield strength exceeds the product of the system overstrength factor as given in Table 4.3-1 and the seismic base shear determined in Sec. 5.2.1, modified to use the effective fundamental period T_e in place of T for the determination of C_s .

A5.2.9.1 Required member force and deformation. For each nonlinear static analysis the design response parameters, including the individual member forces, Q_{Ei} , and member deformations, γ_i , shall be taken as the values obtained from the analysis at the step at which the target displacement is reached.

A5.2.9.2 Member. The adequacy of individual members and their connections to withstand the member forces, Q_{Ei} , and member deformations, γ_i , shall be evaluated based on laboratory test data for similar components. The effects of gravity and other loads on member deformation capacity shall be considered in these evaluations. The deformation of a member supporting gravity loads shall not exceed

(i) two-thirds of the deformation that results in loss of ability to support gravity loads, and (ii) two-thirds of the deformation at which the member strength has deteriorated to less than the 70 percent of the peak strength of the component model. The deformation of a member not required for gravity load support shall not exceed two-thirds of the value at which member strength has deteriorated to less than 70% of the peak strength of the component model. Alternatively, it shall be permissible to deem member deformation to be acceptable if the deformation does not exceed the value determined using the acceptance criteria for nonlinear procedures given in the *Prestandard and Commentary for the Seismic Rehabilitation of Buildings* (FEMA 356) for the Life Safety performance level.

Member forces shall be deemed acceptable if not in excess of expected capacities.

A5.2.10 Design review. An independent team composed of at least two members, consisting of registered design professionals in the appropriate disciplines and others, with experience in seismic analysis methods and the theory and application of nonlinear seismic analysis and structural behavior under earthquake loading, shall perform a review of the design of the seismic force resisting system and the supporting structural analyses. The design review shall include (i) review of any site-specific seismic criteria employed in the analysis including the development of site-specific spectra, and (ii) review of the determination of the target displacement and effective yield strength of the structure.

For those structures with effective yield strength less than the product of the system overstrength factor as given in Table 4.3-1 and the seismic base shear determined in Sec. 5.2.1, modified to use the effective fundamental period T_e in place of T for the determination of C_s , the design review shall further include, but need not be limited to, the following:

1. Review of acceptance criteria used to demonstrate the adequacy of structural elements and systems to withstand the calculated force and deformation demands, together with that laboratory and other data used to substantiate such criteria. Review of the acceptance criteria for nonlinear procedures given in the *Prestandard and Commentary for the Seismic Rehabilitation of Buildings* (FEMA 356) shall be at the discretion of the design review team.
2. Review of the final design of the entire structural system and all supporting analyses. The design review team shall issue a report that identifies, within the scope of the review, significant concerns and any departures from general conformance with the *Provisions*.

REFERENCES

ATC 40 (SSC, 1996) *Seismic Evaluation and Retrofit of Concrete Buildings*, SSC Report No. 96-01, Seismic Safety Commission, State of California, Sacramento, California. Developed by the Applied Technology Council, Redwood City, California.

FEMA 350 (FEMA, 2000a), *Recommended Seismic Design Criteria for New Steel Moment-Frame Buildings*, Federal Emergency Management Agency, Washington, D.C.

FEMA 356 (FEMA, 2000b), *Prestandard and Commentary for the Seismic Rehabilitation of Buildings*, Federal Emergency Management Agency, Washington, D.C.

HAZUS (NIBS, 1999), *HAZUS99 Technical Manual*, National Institute of Building Science, Washington, D.C. Developed by the Federal Emergency Management Agency through agreements with the National Institute of Building Sciences.

Chapter 6

ARCHITECTURAL, MECHANICAL, AND ELECTRICAL COMPONENT DESIGN REQUIREMENTS

6.1 GENERAL

6.1.1 Scope. This chapter establishes minimum design criteria for nonstructural components that are permanently attached to structures and for their supports and attachments.

Exception: The following components are exempt from the requirements of this chapter.

1. Architectural components in Seismic Design Category B, other than parapets supported by bearing walls or shear walls, where the component importance factor, I_p , is equal to 1.0.
2. Mechanical and electrical components in Seismic Design Category B.
3. Mechanical and electrical components in Seismic Design Category C where the importance factor, I_p , is equal to 1.0.
4. Mechanical and electrical components in Seismic Design Category D, E, or F where the component importance factor, I_p , is equal to 1.0 and both of the following conditions apply:
 - a. flexible connections between the components and associated ductwork, piping, and conduit are provided, and
 - b. components are mounted at 4 ft (1.22 m) or less above a floor level and weigh 400 lb (1780 N) or less.
5. Mechanical and electrical components in Seismic Design Category C, D, E, or F where the component importance factor, I_p , is equal to 1.0 and both the following conditions apply:
 - a. flexible connections between the components and associated ductwork, piping, and conduit are provided, and
 - b. the components weigh 20 lb (95 N) or less or, for distribution systems, weigh 5 lb/ft (7 N/m) or less.

Design criteria for storage racks, storage tanks, and nonbuilding structures that are supported by other structures are provided in Chapter 14.

Where the individual weight of supported components and nonbuilding structures with periods greater than 0.06 seconds exceeds 25 percent of the total seismic weight W , the structure shall be designed considering interaction effects between the structure and the supported components.

Testing shall be permitted to be used in lieu of analysis methods outlined in this chapter to determine the seismic capacity of components and their supports and attachments. Thus, adoption of a nationally recognized standard, such as AC-156, is acceptable so long as the seismic capacities equal or exceed the demands determined in accordance with Sec. 6.2.

6.1.2 References

6.1.2.1 Use of Standards. Where a reference standard provides a basis for the earthquake-resistant design of a particular type of system or component, that standard may be used, subject to the following conditions:

1. The design earthquake forces shall not be less than those determined in accordance with Sec. 6.2.6.
2. Each component's seismic interactions with all other connected components and with the supporting structure shall be accounted for in the design. The component shall accommodate drifts,

deflections, and relative displacements determined in accordance with the applicable sections of the *Provisions*

6.1.2.2 Adopted References. The following references are adopted and are to be considered part of these *Provisions* to the extent referred to in this chapter:

- ASME A17.1 *Safety Code For Elevators And Escalators*, American Society of Mechanical Engineers, 1996.
- ASME B31.1 *Power Piping*, American Society of Mechanical Engineers, 2001.
- ASME B31.3 *Process Piping*, American Society of Mechanical Engineers, 2002.
- ASME B31.4 *Liquid Transportation Systems for Hydrocarbons, Liquid Petroleum Gas, Anhydrous Ammonia, and Alcohols*, American Society of Mechanical Engineers, 2002.
- ASME B31.5 *Refrigeration Piping*, American Society of Mechanical Engineers, 2001.
- ASME B31.8 *Gas Transmission and Distribution Piping Systems*, American Society of Mechanical Engineers, 1995.
- ASME B31.9 *Building Services Piping*, American Society of Mechanical Engineers, 1996.
- ASME B31.11 *Slurry Transportation Piping Systems*, American Society of Mechanical Engineers, 1989 (reaffirmed, 1998).
- ASME BPV *Boiler and Pressure Vessel Code*, American Society of Mechanical Engineers, including addenda through 2002.
- IEEE-344 *Recommended Practice for Seismic Qualification of Class I E Equipment for Nuclear Power Generating Stations*, Institute of Electrical and Electronic Engineers, 1987.
- NFPA-13 *Standard for the Installation of Sprinkler Systems*, National Fire Protection Association, 2000, including TIA 02-1 (NFPA 13) (SC 03-7-8 / Log No. 748).

6.1.2.3 Other references. The following references are developed within the industry and represent acceptable procedures for design and construction:

- AAMA 501.6 *Recommended Dynamic Test Method for Determining the Seismic Drift Causing Glass Fallout from a Wall System*, American Architectural Manufacturers Association, 2001.
- AC-156 *Acceptance Criteria for Seismic Qualification Testing of Nonstructural Components (AC 156)*, International Conference of Building Officials Evaluation Service, 2000.
- ASHRAE *Handbook, "Seismic Restraint Design,"* American Society of Heating, Ventilating, and Air Conditioning, 1999.
- CISCA 0-2 *Recommendations for Direct-Hung Acoustical Tile and Lay-in Panel Ceilings, Seismic Zones 0-2*, Ceilings and Interior Systems Construction Association, 1991.
- CISCA 3-4 *Recommendations for Direct-Hung Acoustical Tile and Lay-in Panel Ceilings, Seismic Zones 3-4*, Ceilings and Interior Systems Construction Association, 1991.
- SMACNA 95 *HVAC Duct Construction Standards, Metal and Flexible*, Sheet Metal and Air Conditioning Contractors National Association, 1995.
- SMACNA 80 *Rectangular Industrial Duct Construction Standards*, Sheet Metal and Air Conditioning Contractors National Association, 1980.
- SMACNA 98 *Seismic Restraint Manual Guidelines for Mechanical Systems*, Sheet Metal and Air Conditioning Contractors National Association, 1991, including Appendix B, 1998.

6.1.3 Definitions

Appendage: An architectural component such as a canopy, marquee, ornamental balcony, or statuary.

Attachments: Means by which components and their supports are secured and connected to the seismic-force-resisting system of the structure. Such attachments include anchor bolts, welded connections, and mechanical fasteners.

Base: See Sec. 4.1.3.

Component: See Sec. 1.1.4.

Construction documents: See Sec. 2.1.3.

Deformability: The ratio of the ultimate deformation to the limit deformation.

Enclosure: An interior space surrounded by walls.

Flexible component: Component, including its attachments, having a fundamental period greater than 0.06 sec.

Glazed curtain wall: A nonbearing wall that extends beyond the edges of the building floor slabs and includes a glazing material installed in the curtain wall framing.

Glazed partition: A partition that includes a glazing material installed in its framing.

Glazed storefront: A nonbearing wall that is installed between floor slabs, typically including entrances, and includes a glazing material installed in the storefront framing.

Grade plane: A reference plane representing the average of the finished ground level adjoining the structure at the exterior walls. Where the finished ground level slopes away from the exterior walls, the reference plane shall be established by the lowest points within the area between the buildings and the lot line or, where the lot line is more than 6 ft (1829 mm) from the structure between the structure and a point 6 ft (1829 mm) from the structure.

Hazardous material: See Sec. 1.1.4.

High deformability element: An element whose deformability is not less than 3.5 when subjected to four fully reversed cycles at the limit deformation.

Limit deformation: Two times the initial deformation that occurs at a load equal to 40 percent of the maximum strength.

Limited deformability element: An element that is neither a low deformability nor a high deformability element.

Low deformability element: An element whose deformability is 1.5 or less.

Nonbearing wall: An exterior or interior wall that does not provide support for vertical loads other than its own weight or as permitted by the building code administered by the authority having jurisdiction.

Nonbuilding structure: See Sec. 14.1.3.

Nonstructural wall: All walls other than bearing walls or shear walls.

Owner: See Sec. 1.1.4.

Partition: See Sec. 5.1.2.

Registered design professional: See Sec. 2.1.3.

Rigid component: Component, including its attachments, having a fundamental period less than or equal to 0.06 sec.

Seismic Design Category: See Sec. 1.1.4.

Seismic Use Group: See Sec. 1.1.4.

Special inspector: See Sec. 2.1.3.

Structure: See Sec. 1.1.4.

Supports: Those structural members, assemblies of members, or manufactured elements, including braces, frames, legs, lugs, snuggers, hangers, saddles, or struts, that transmit loads between the nonstructural components and the structure.

Ultimate deformation: The deformation at which failure occurs and which shall be deemed to occur if sustainable load reduces to 80 percent or less of the maximum strength.

Utility or service interface: The connection of the structure's mechanical and electrical distribution systems to the utility or service company's distribution system.

6.1.4 Notation

A_x	The torsional amplification factor determined using Eq. 5.2-13
a_i	Acceleration at Level i obtained by modal analysis.
a_p	The component amplification factor selected, as appropriate, from Table 6.3-1 or 6.4-1.
b_p	The width of the rectangular glass.
c_1	The clearance (gap) between vertical glass edges and the frame.
c_2	The clearance (gap) between horizontal glass edges and the frame.
D_{clear}	The relative horizontal (drift) displacement, measured over the height of the glass panel under consideration, which causes initial glass-to-frame contact. For rectangular glass panels within a rectangular wall frame, D_{clear} is given by Eq. 6.3-2.
D_p	Relative seismic displacement that the component must be designed to accommodate as defined in Sec. 6.2.7.
F_p	The seismic design force applicable to a particular nonstructural component.
g	Acceleration due to gravity.
h	The average roof height of structure above the base.
h_p	The height of the rectangular glass.
h_{sx}	Story height used in the definition of the allowable drift, Δ_a , in Table 4.5-1. Note that Δ_a/h_{sx} is the allowable drift index.
I_p	The component importance factor as prescribed in Sec. 6.2.2.
K_p	The stiffness of the system comprising the component and its supports and attachments, determined in terms of load per unit deflection at the center of gravity of the component.
Q_E	The effect of horizontal seismic forces. See Sec. 4.1.4.
R	Response modification coefficient. See Sec. 4.1.4.
R_p	The component response modification factor selected, as appropriate, from Table 6.3-1 or 6.4-1.
S_{D1}	The design, 5-percent-damped, spectral response acceleration parameter at a period of 1 second as defined in Sec. 3.3.3.

S_{DS}	The short period spectral acceleration parameter, determined in Sec. 3.3.3.
T_p	The fundamental period of a component (including its supports and attachments) as defined in Sec. 6.4.1.
W_p	Operating weight of a nonstructural component.
X	Height above the base of the upper support attachment (at level x).
Y	Height above the base of lower support attachment (at level y).
z	The height above the base of the point of attachment of the component, but z shall not be taken less than 0 and the value of z/h need not exceed 1.0.
Δ_{aA}	Allowable story drift for structure A, as defined in Table 4.5-1.
Δ_{aB}	Allowable story drift for structure B, as defined in Table 4.5-1.
Δ_{fallout}	The relative seismic displacement (drift) at which glass fallout from the curtain wall, storefront or partition occurs.
δ_{xA}	Deflection at level x of structure A, determined in accordance with Sec. 5.2.6, 5.3.5, or 5.4.3.
δ_{yA}	Deflection at level y of structure A, determined in accordance with Sec. 5.2.6, 5.3.5, or 5.4.3.
δ_{yB}	Deflection at level y of structure B, determined in accordance with Sec. 5.2.6, 5.3.5, or 5.4.3.
ρ	The redundancy factor as defined in Sec. 4.3.3.

6.2 GENERAL DESIGN REQUIREMENTS

Nonstructural components shall satisfy the requirements of this section. In addition to these general requirements, the requirements indicated in Table 6.2-1 shall apply.

Table 6.2-1 Additional Requirements for Nonstructural Components

Component Type	<i>Provisions Reference</i>	
	Quality Assurance	Design
Architectural components, including their supports and attachments	2.3.9	6.3
Mechanical and electrical components, including their supports and attachments	2.3.10 2.4.5	6.4

6.2.1 Seismic Design Category. For the purposes of this chapter, components shall be assigned to the same Seismic Design Category as the structure that they occupy or to which they are attached.

6.2.2 Component importance factor. All components shall be assigned a component importance factor as indicated in this section. The component importance factor, I_p , shall be taken as 1.5 if any of the following conditions apply:

1. The component is required to function after an earthquake,
2. The component contains hazardous materials, or
3. The component is in or attached to a Seismic Use Group III structure and it is needed for continued operation of the facility or its failure could impair the continued operation of the facility.

All other components shall be assigned a component importance factor, I_p , equal to 1.0.

6.2.3 Consequential damage. The functional and physical interrelationship of components and their effect on each other shall be considered so that the failure of an essential or nonessential architectural, mechanical, or electrical component shall not cause the failure of an essential architectural, mechanical, or electrical component.

6.2.4 Flexibility. The design and evaluation of components, supports, and attachments shall consider their flexibility as well as their strength.

6.2.5 Component force transfer. Components shall be attached such that the component forces are transferred to the structure. Component attachments that are intended to resist seismic forces shall be bolted, welded, or otherwise positively fastened without consideration of frictional resistance produced by the effects of gravity. A continuous load path of sufficient strength and stiffness between the component and the supporting structure shall be verified. Local elements of the supporting structure shall be designed for the component forces where such forces control the design of the elements or their connections. In this instance, the component forces shall be those determined in Section 6.2.6, except that modifications to F_p and R_p due to anchorage conditions need not be considered. The design documents shall include sufficient information concerning the attachments to verify compliance with the requirements of these Provisions.

6.2.6 Seismic forces. The seismic design force, F_p , applied in the horizontal direction shall be centered at the component's center of gravity and distributed relative to the component's mass distribution and shall be determined in accordance with Eq. 6.2-1 as follows:

$$F_p = \frac{0.4a_p S_{DS} W_p}{R_p / I_p} \left(1 + 2 \frac{z}{h} \right) \quad (6.2-1)$$

Exception: If the component period, T_p , is greater than T_{flx} where $T_{flx} = (1 + 0.25 z/h) S_{D1}/S_{DS}$, the value of F_p may be reduced by the ratio of T_{flx}/T_p .

In lieu of the forces determined in accordance with Eq. 6.2-1, accelerations at any level may be determined by the response spectrum procedure of Sec. 5.3 with R equal to 1.0, in which case seismic forces shall be determined in accordance with Eq. 6.2-2 as follows:

$$F_p = A_x \frac{a_i a_p W_p}{R_p / I_p} \quad (6.2-2)$$

F_p is not required to be taken as greater than:

$$F_p = 1.6 S_{DS} I_p W_p \quad (6.2-3)$$

Exception: If the component period, T_p , is greater than T_{flx} where $T_{flx} = (1 + 0.25 z/h) S_{D1}/S_{DS}$, the upper limit value of F_p may be reduced by the ratio of T_{flx}/T_p .

and F_p shall not be taken as less than:

$$F_p = 0.3 S_{DS} I_p W_p \quad (6.2-4)$$

The force F_p shall be independently applied in each of two orthogonal horizontal directions in combination with service loads. In addition, the nonstructural component shall be designed for a concurrent vertical force $\pm 0.2 S_{DS} W_p$. The reliability/redundancy factor, ρ , and the overstrength factor Ω_o are not applicable.

Where wind loads on nonstructural exterior walls or building code horizontal loads on interior partitions exceed F_p , such loads shall govern the strength design, but the detailing requirements and limitations prescribed in this chapter shall apply.

6.2.6.1 Allowable Stress Design. Where an adopted reference provides a basis for the earthquake-resistant design of a particular type of system or component, and the same reference defines acceptance

criteria in terms of allowable stresses rather than strengths, that reference shall be permitted to be used. The allowable stress load combination shall consider dead, live, operating, and earthquake loads. The earthquake loads determined in accordance with the *Provisions* shall be multiplied by a factor of 0.7. The allowable stress design load combinations of ASCE 7 need not be used. The component or system shall also accommodate the relative displacements specified in Section 6.2.7.

6.2.6.2 Seismic Design Force. The seismic design force, F_p , shall be centered at the component's center of gravity and distributed relative to the component's mass distribution and shall be determined in accordance with Eq. 6.2-1.

6.2.7 Seismic relative displacements. The relative seismic displacements, D_p , for use in component design shall be determined in accordance with Eq. 6.2-5 as follows:

$$D_p = \delta_{xA} - \delta_{yA} \quad (6.2-5)$$

D_p is not required to be taken greater than:

$$D_p = (X - Y) \frac{\Delta_{aA}}{h_{sx}} \quad (6.2-6)$$

For two connection points on separate structures, A and B, or separate structural systems, one at level x and the other at level y , D_p shall be determined in accordance with Eq. 6.2-7 as follows:

$$D_p = |\delta_{xA}| + |\delta_{yB}| \quad (6.2-7)$$

D_p is not required to be taken as greater than:

$$D_p = \frac{X \Delta_{aA}}{h_{sx}} + \frac{Y \Delta_{aB}}{h_{sx}} \quad (6.2-8)$$

The effects of relative seismic displacement shall be considered in combination with displacement caused by other loads as appropriate.

6.2.8 Component anchorage. Components shall be anchored in accordance with the requirements of this section and the anchorage shall satisfy the requirements for the parent material as set forth elsewhere in these *Provisions*.

6.2.8.1 Design forces. The forces in the connected part shall be determined based on the prescribed forces for the component specified in Sec. 6.2.6. The value of R_p used in Sec. 6.2.6 to determine the forces in the connected part shall not exceed 1.5 unless:

- a. The component anchorage is designed to be governed by the strength of a ductile steel element, or
- b. The design of anchors in concrete used for the component anchorage is based on Sec. 9.6.4.4.3 whereby post-installed anchors shall be pre-qualified for seismic applications per ACI 355.2-01.

6.2.8.2 Anchors in concrete or masonry. Anchors embedded in concrete or masonry shall be proportioned to carry the least of the following:

1. The design strength of the connected part,
2. 1.3 times the force in the connected part due to the prescribed forces, and
3. The maximum force that can be transferred to the connected part by the component structural system.

6.2.8.3 Installation conditions. Determination of forces in anchors shall take into account the expected conditions of installation including eccentricities and prying effects.

6.2.8.4 Multiple anchors. Determination of force distribution of multiple anchors at one location shall take into account the stiffness and ductility of the connected system and its ability to redistribute loads to other anchors in the group. Designs of anchorage in concrete in accordance with Sec. 9.6 shall be considered to satisfy this requirement.

6.2.8.5 Power actuated fasteners. Power actuated fasteners shall not be used for tension load applications in Seismic Design Category D, E, or F unless approved for such loading.

6.2.9 Construction documents. Where design of nonstructural components or their supports and attachments is required by these Provisions (as indicated in Table 6.2-1), such design shall be shown in construction documents prepared by a registered design professional for use by the owner, building officials, contractors, and inspectors. Such documents shall include a quality assurance plan as required by Sec. 2.2.

6.3 ARCHITECTURAL COMPONENTS

Architectural components, and their supports and attachments, shall satisfy the requirements of this section. Appropriate coefficients shall be selected from Table 6.3-1.

Exception: Components supported by chains or otherwise suspended from the structure are not required to satisfy the seismic force and relative displacement requirements provided they meet all of the following criteria:

1. The design load for such items shall be equal to 1.4 times the operating weight acting down with a simultaneous horizontal load equal to 1.4 times the operating weight. The horizontal load shall be applied in the direction that results in the most critical loading for design.
2. Seismic interaction effects shall be considered in accordance with Sec.6.2.3.
3. The connection to the structure shall allow a 360-degree range of horizontal motion.

Table 6.3-1 Coefficients for Architectural Components

Architectural Component or Element	a_p^a	R_p
Interior nonstructural walls and partitions ^b		
Plain masonry walls	1.0	1.5
All other walls and partitions	1.0	2.5
Cantilever Elements, unbraced or braced (to structural frame) below their centers of mass	2.5	2.5
Parapets and cantilevered interior nonstructural walls	2.5	2.5
Chimneys and stacks where laterally supported by structures		
Cantilever elements, braced (to structural frame) above their centers of mass		
Parapets	1.0	2.5
Chimneys and stacks	1.0	2.5
Exterior nonstructural walls ^b	1.0	2.5
Exterior nonstructural wall elements and connections ^b		
Wall element	1.0	2.5
Body of wall-panel connections	1.0	2.5
Fasteners of the connecting system	1.25	1.0
Veneer		
High deformability elements and attachments	1.0	2.5
Low deformability elements and attachments	1.0	1.5
Penthouses (except where framed by an extension of the building frame)	2.5	3.5

Ceilings All	1.0	2.5
Cabinets Storage cabinets and laboratory equipment	1.0	2.5
Access floors Special access floors All other	1.0 1.0	2.5 1.5
Appendages and ornamentation	2.5	2.5
Signs and billboards	2.5	2.5
Other rigid components High deformability elements and attachments Limited deformability elements and attachments Low deformability elements and attachments	1.0 1.0 1.0	3.5 2.5 1.5
Other flexible components High deformability elements and attachments Limited deformability elements and attachments Low deformability elements and attachments	2.5 2.5 2.5	3.5 2.5 1.5
^a A lower value for a_p is permitted where justified by detailed dynamic analysis. The value for a_p shall not be less than 1.0. The value of a_p equal to 1.0 is for rigid components and rigidly attached components. The value of a_p equal to 2.5 is for flexible components and flexibly attached components. ^b Where flexible diaphragms provide lateral support for concrete or masonry walls or partitions, the design forces for anchorage to the diaphragm shall be as specified in Sec. 4.6.2.1.		

6.3.1 Forces and displacements. All architectural components, and their supports and attachments, shall be designed for the seismic forces defined in Sec. 6.2.6.

Architectural components that could pose a life-safety hazard shall be designed to accommodate the seismic relative displacements defined in Sec. 6.2.7. Architectural components shall be designed considering vertical deflection due to joint rotation of horizontally cantilevered structural members.

6.3.2 Exterior nonstructural wall elements and connections. Exterior nonstructural wall panels or elements that are attached to or enclose the structure shall be designed to accommodate the seismic relative displacements defined in Sec. 6.2.7 and movements due to temperature changes. Such elements shall be supported by means of positive and direct structural supports or by mechanical connections and fasteners in accordance with the following requirements:

1. Connections and panel joints shall allow for a relative movement between stories of not less than the calculated story drift D_p or 1/2 in. (13 mm), whichever is greater.
2. Connections to permit movement in the plane of the panel for story drift shall be sliding connections using slotted or oversized holes, connections that permit movements by bending of steel, or other connections that provide equivalent sliding or ductile capacity.
3. Bodies of connectors shall have sufficient deformability and rotation capacity to preclude fracture of the concrete or low deformation failures at or near welds.
4. All fasteners in the connecting system such as bolts, inserts, welds, and dowels and the body of the connectors shall be designed for the seismic force F_p determined by Eq. 6.2-3, using values of a_p and R_p taken from Table 6.3-1, applied at the center of mass of the panel.
5. Where anchorage is achieved using flat straps embedded in concrete or masonry, such straps shall be attached to or hooked around reinforcing steel or otherwise terminated so as to effectively transfer forces to the reinforcing steel.

Glass in glazed curtain walls and storefronts shall be designed and installed in accordance with Sec. 6.3.7.

6.3.3 Out-of-plane bending. Transverse or out-of-plane bending or deformation of a component or system that is subjected to forces as determined in Sec. 6.2.6 shall not exceed the deflection capacity of the component or system.

6.3.4 Suspended ceilings. Suspended ceilings shall satisfy the requirements of this section.

6.3.4.1 Seismic forces. The weight of the ceiling, W_p , shall include the ceiling grid and panels; light fixtures if attached to, clipped to, or laterally supported by the ceiling grid; and other components which are laterally supported by the ceiling. W_p shall not be taken as less than 4 psf (0.2 kN/m²).

The seismic force, F_p , shall be transmitted through the ceiling attachments to the building structural elements or the ceiling-structure boundary.

6.3.4.2 Industry standard construction. Unless designed in accordance with Sec. 6.3.4.3, suspended ceilings shall be designed and constructed in accordance with this section.

6.3.4.2.1 Seismic Design Category C. Suspended ceilings in Seismic Design Category C shall be designed and installed in accordance with CISCA 0-2, except that seismic forces shall be determined in accordance with Sec. 6.2.6 and 6.3.4.1.

Sprinkler heads and other penetrations in Seismic Design Category C shall have a minimum clearance of 1/4 in. (6 mm) on all sides.

6.3.4.2.2 Seismic Design Categories D, E, and F. Suspended ceilings in Seismic Design Category D, E, or F shall be designed and installed in accordance with CISCA 3-4 and the requirements of this section.

1. A heavy-duty T-bar grid system shall be used.
2. The width of the perimeter supporting closure angle shall not be less than 2.0 in. (50 mm). In each orthogonal horizontal direction, one end of the ceiling grid shall be attached to the closure angle. The other end in each horizontal direction shall have a 3/4 in. (19 mm) clearance from the wall and shall rest upon and be free to slide on a closure angle.
3. For ceiling areas exceeding 1000 ft² (93m²), horizontal restraint of the ceiling to the structural system shall be provided by means of splay wires. The tributary areas of the horizontal restraints shall be approximately equal.

Exception: Rigid braces are permitted to be used instead of diagonal splay wires. Braces and the attachments to the structural system above shall be adequate to limit relative lateral deflections at the point of attachment to the ceiling grid to less than 1/4 in. (6 mm) when subjected to the loads prescribed in Sec. 6.2.6.

4. For ceiling areas exceeding 2500 ft² (230 m²), a seismic separation joint or full height partition that breaks the ceiling into areas not exceeding 2500 ft² shall be provided unless structural analyses of the ceiling bracing system for the prescribed seismic forces demonstrate that ceiling system penetrations and closure angles provide sufficient clearance to accommodate the additional movement. Each area shall be provided with closure angles in accordance with Item 2 and horizontal restraints or bracing in accordance with Item 3.
5. Except where rigid braces are used to limit lateral deflections, sprinkler heads and other penetrations shall have a 2 in. (50 mm) oversized ring, sleeve, or adapter through the ceiling tile to allow for free movement of at least 1 in. (25 mm) in all horizontal directions. Alternatively, a swing joint that can accommodate 1 in. (25 mm) of ceiling movement in all horizontal directions is permitted to be provided at the top of the sprinkler head extension.
6. Changes in ceiling elevation shall be provided with positive bracing.

7. Cable trays and electrical conduits shall be supported independently of the ceiling.
8. Suspended ceilings shall be subject to the special inspection requirements of Sec. 2.3.9 of these *Provisions*.

6.3.4.3 Integral construction. As an alternative to providing large clearances around sprinkler system penetrations through ceiling systems, the sprinkler system and ceiling grid are permitted to be designed and tied together as an integral unit. Such a design shall consider the mass and flexibility of all elements involved, including: ceiling system, sprinkler system, light fixtures, and mechanical (HVAC) appurtenances. Such design shall be performed by a registered design professional.

6.3.5 Access floors

6.3.5.1 General. Access floors shall satisfy the requirements of this section. The weight of the access floor, W_p , shall include the weight of the floor system, 100 percent of the weight of all equipment fastened to the floor, and 25 percent of the weight of all equipment supported by, but not fastened to the floor. The seismic force, F_p , shall be transmitted from the top surface of the access floor to the supporting structure.

Overturning effects of equipment fastened to the access floor panels also shall be considered. The ability of “slip on” heads for pedestals shall be evaluated for suitability to transfer overturning effects of equipment.

Where checking individual pedestals for overturning effects, the maximum concurrent axial load shall not exceed the portion of W_p assigned to the pedestal under consideration.

6.3.5.2 Special access floors. Access floors shall be considered to be “special access floors” if they are designed in accordance with the following considerations:

1. Connections transmitting seismic loads consist of mechanical fasteners, anchors complying with the requirements of Sec.9.6, welding, or bearing. Design load capacities comply with recognized design codes and/or certified test results.
2. Seismic loads are not transmitted by power actuated fasteners, adhesives, or by friction produced solely by the effects of gravity.
3. The bracing system shall be designed considering the destabilizing effects of individual members buckling in compression.
4. Bracing and pedestals are of structural or mechanical shape produced to ASTM specifications that specify minimum mechanical properties. Electrical tubing shall not be used.
5. Floor stringers that are designed to carry axial seismic loads and are mechanically fastened to the supporting pedestals are used.

6.3.6 Partitions. Partitions that are tied to the ceiling and all partitions greater than 6 ft (1.8 m) in height shall be laterally braced to the building structure. Such bracing shall be independent of any ceiling splay bracing. Bracing shall be spaced to limit horizontal deflection at the partition head to be comparable with ceiling deflection requirements as determined in Sec. 6.3.4 for suspended ceilings and Sec. 6.3.1 for other systems.

Glass in glazed partitions shall be designed and installed in accordance with Sec. 6.3.7.

6.3.7 General. Glass in glazed curtain walls, glazed storefronts and glazed partitions shall meet the relative displacement requirement of Eq. 6.3-1:

$$\Delta_{\text{fallout}} \geq 1.25 I D_p \text{ or } 0.5 \text{ in. (13mm), whichever is greater.} \tag{6.3-1}$$

D_p , the relative seismic displacement that the glazed curtain walls, glazed storefronts or glazed partitions component must be designed to accommodate (Eq. 6.2-5) shall be determined over the height of the

glass component under consideration.

Exceptions:

1. Glass with sufficient clearances from its frame such that physical contact between the glass and frame will not occur at the design drift, as demonstrated by Eq. 6.3-2, shall be exempted from the provisions of Eq. 6.3-1:

$$D_{\text{clear}} \geq 1.25 D_p \quad (6.3-2)$$

Where:

$$D_{\text{clear}} = 2c_1 \left(1 + \frac{h_p c_2}{b_p c_1} \right)$$

2. Fully tempered monolithic glass in Seismic Use Groups I and II located no more than 10 ft (3 m) above a walking surface shall be exempted from the provisions of Eq. 6.3-1.
3. Annealed or heat-strengthened laminated glass in single thickness with interlayer no less than 0.030 in. (0.76 mm) that is captured mechanically in a wall system glazing pocket, and whose perimeter is secured to the frame by a wet glazed gunable curing elastomeric sealant perimeter bead of 1/2 in. (13 mm) minimum glass contact width, or other approved anchorage system, shall be exempted from the provisions of Eq. 6.3-1.

6.3.8 Seismic Drift Limits for Glass Components. Δ_{fallout} , the drift causing glass fallout from the curtain wall, storefront or partition, shall be determined in accordance with AAMA 501.6, or by engineering analysis.

6.4 MECHANICAL AND ELECTRICAL COMPONENTS

Mechanical and electrical components, and their supports and attachments, shall satisfy the requirements of this section. Appropriate coefficients shall be selected from Table 6.4-1.

Exception: Light fixtures, lighted signs, and ceiling fans not connected to ducts or piping, that are supported by chains or otherwise suspended from the structure, are not required to satisfy the seismic force and relative displacement requirements provided they meet all of the following criteria:

1. The design load for such items shall be 1.4 times the operating weight acting down with a simultaneous horizontal load equal to 1.4 times the operating weight. The horizontal load shall be applied in the direction which results in the most critical loading for design.
2. Seismic interaction effects shall be considered in accordance with Sec. 6.2.3.
3. The connection to the structure shall allow a 360-degree range of horizontal motion.

As an alternative to the analysis methods outlined in this section, testing is an acceptable method to determine the seismic capacity of components, and their supports and attachments. Thus, adaptation of a nationally recognized standard is acceptable so long as the seismic capacities equal or exceed the demands determined in accordance with Sec. 6.2.6 and 6.2.7.

Table 6.4-1 Coefficients for Mechanical and Electrical Components

Mechanical or Electrical Component or Element ^b	a_p^a	R_p
General Mechanical		

Boilers and Furnaces	1.0	2.5
Pressure vessels on skirts and free-standing	2.5	2.5
Stacks	2.5	2.5
Cantilevered chimneys	2.5	2.5
Other	1.0	2.5
Manufacturing and Process Machinery		
General	1.0	2.5
Conveyors (non-personnel)	2.5	2.5
Piping Systems		
High deformability elements and attachments	1.0	3.5
Limited deformability elements and attachments	1.0	2.5
Low deformability elements and attachments	1.0	1.5
HVAC System Component		
Vibration isolated	2.5	2.5
Non-vibration isolated	1.0	2.5
Mounted in-line with ductwork	1.0	2.5
Other	1.0	2.5
Elevator Components	1.0	2.5
Escalator Components	1.0	2.5
Trussed Towers (free-standing or guyed)	2.5	2.5
General Electrical		
Distribution systems (bus ducts, conduit, cable tray)	2.5	5
Equipment	1.0	2.5
Lighting Fixtures	1.0	1.5
<p>^a A lower value for a_p is permitted where justified by detailed dynamic analysis. The value for a_p shall not be less than 1.0. The value of a_p equal to 1.0 is for rigid components and rigidly attached components. The value of a_p equal to 2.5 is for flexible components and flexibly attached components.</p> <p>^b Components mounted on vibration isolators shall have a bumper restraint or snubber in each horizontal direction. The design force shall be taken as $2F_p$ if the nominal clearance (air gap) between the equipment support frame and restraint is greater than 0.25 in. If the nominal clearance specified on the construction documents is not greater than 0.25 in., the design force may be taken as F_p.</p>		

Where design of mechanical and electrical components for seismic effects is required, consideration shall be given to the dynamic effects of the components, their contents, and where appropriate, their supports. In such cases, the interaction between the components and the supporting structures, including other mechanical and electrical components, shall also be considered.

Some complex equipment such as valve operators, turbines and generators, and pumps and motors are permitted to be functionally connected by mechanical links that are not capable of transferring the seismic loads or accommodating seismic relative displacements. Such items may require special design considerations such as a common rigid support or skid.

6.4.1 Component period. Where the dynamic response of a mechanical or electrical component (including its supports and attachments) can reasonably be approximated by a spring-and-mass single-degree-of-freedom system, the fundamental period of the component, T_p , may be determined using Eq. 6.4-1 as follows:

$$T_p = 2\pi \sqrt{\frac{W_p}{K_p g}} \quad (6.4-1)$$

Alternatively, the fundamental period of the component, T_p , may be determined from experimental test data or by a properly substantiated analysis.

6.4.2 Mechanical components. Mechanical components with I_p greater than 1.0 shall be designed for the seismic forces and relative displacements defined in Sec. 6.2.6 and 6.2.7 and shall satisfy the following additional requirements:

1. Provision shall be made to eliminate seismic impact for components vulnerable to impact, for components constructed of nonductile materials, and in cases where material ductility will be reduced due to service conditions (such as low temperature applications).
2. The possibility of loads imposed on components by attached utility or service lines, due to differential movement of support points on separate structures, shall be evaluated.
3. Where mechanical components contain a sufficient quantity of hazardous material to pose a danger if released and for boilers and pressure vessels not designed in accordance with ASME BPV, the design strength for seismic loads in combination with other service loads and appropriate environmental effects (such as corrosion) shall be based on the following material properties:
 - a. For mechanical components constructed with ductile materials (such as steel, aluminum, or copper), 90 percent of the minimum specified yield strength.
 - b. For threaded connections in components constructed with ductile materials, 70 percent of the minimum specified yield strength.
 - c. For mechanical components constructed with nonductile materials (such as plastic, cast iron, or ceramics), 25 percent of the minimum specified tensile strength.
 - d. For threaded connections in components constructed with nonductile materials, 20 percent of the minimum specified tensile strength.
4. Where piping or HVAC ductwork components are attached to structures that could displace relative to one another and for isolated structures where such components cross the isolation interface, the components shall be designed to accommodate the seismic relative displacements defined in Sec. 6.2.7.

6.4.3 Electrical components. Electrical components with I_p greater than 1.0 shall be designed for the seismic forces and relative displacements defined in Sec. 6.2.6 and 6.2.7 and shall satisfy the following additional requirements:

1. Provision shall be made to eliminate seismic impact between components.
2. Evaluate loads imposed on the components by attached utility or service lines which are also attached to separate structures.
3. Batteries on racks shall have wrap-around restraints to ensure that the batteries will not fall from the rack. Spacers shall be used between restraints and cells to prevent damage to cases. Racks shall be evaluated for sufficient lateral load capacity.
4. Internal coils of dry type transformers shall be positively attached to their supporting substructure within the transformer enclosure.
5. Electrical control panels, computer equipment, and other items with slide-out components shall have a latching mechanism to hold the components in place.
6. Electrical cabinet design shall comply with the applicable National Electrical Manufacturers Association (NEMA) standards. Cut-outs in the lower shear panel that do not appear to have been

made by the manufacturer and are judged to reduce significantly the strength of the cabinet shall be specifically evaluated.

7. The attachments for additional external items weighing more than 100 lb (445 N) shall be specifically evaluated if not provided by the manufacturer.
8. Where conduit, cable trays, or similar electrical distribution components are attached to structures that could displace relative to one another and for isolated structures where such components cross the isolation interface, the components shall be designed to accommodate the seismic relative displacements defined in Sec. 6.2.7.

6.4.4 Supports and attachments

Supports and attachments for mechanical and electrical components shall be designed for the seismic forces defined in Sec. 6.2.6 and shall satisfy the requirements found elsewhere in these *Provisions*, as appropriate, for the materials comprising the means of attachment.

Supports for components shall be designed to accommodate the seismic relative displacements between points of support as determined in accordance with Sec. 6.2.7. Supports for components may be forged or cast so as to form an integral part of the mechanical or electrical component. Attachments between the component and its supports, except where integral, shall be designed to accommodate both the forces and displacements determined in accordance with Sec. 6.2.6 and 6.2.7. Where I_p is greater than 1.0, the effect of load transfer on the component wall at the point of attachment shall be evaluated.

The following additional requirements shall apply:

1. Supports and attachments that transfer seismic loads shall be constructed of materials suitable for the application and shall be designed and constructed in accordance with a nationally recognized standard specification, such as those listed in Sec. 6.1.2.
2. Seismic supports shall be constructed so that support engagement is maintained.
3. Friction clips shall not be used for anchorage attachment.
4. Oversized plate washers extending to the component wall shall be used at bolted connections through the sheet metal base if the base is not reinforced with stiffeners or is not judged to be capable of transferring the required loads.
5. Where weak-axis bending of cold-formed steel supports is relied on for the seismic load path, such supports shall be specifically evaluated.
6. Components mounted on vibration isolators shall have a bumper restraint or snubber in each horizontal direction, and vertical restraints shall be provided where required to resist overturning. Isolator housings and restraints shall be constructed of ductile materials. (See additional design force requirements in Table 6.4-1.) A viscoelastic pad or similar material of appropriate thickness shall be used between the bumper and components to limit the impact load.
7. Expansion anchors shall not be used for non-vibration isolated mechanical equipment rated over 10 hp (7.45 kW).

Exception: Undercut expansion anchors are permitted.

8. The supports for electrical distribution components shall be designed for the seismic forces and relative displacements defined in Sec. 6.2.6 and 6.2.7 if any of the following conditions apply:
 - a. Supports are cantilevered up from the floor;
 - b. Supports include bracing to limit deflection;
 - c. Supports are constructed as rigid welded frames;
 - d. Attachments into concrete utilize non-expanding insets, powder driven fasteners, or cast iron

embedments; or

- e. Attachments utilize spot welds, plug welds, or minimum size welds as defined by AISC.

9. For boilers and pressure vessels, attachments to concrete shall be suitable for cyclic loads.

6.4.5 Utility and service lines. At the interface of adjacent structures or portions of the same structure that may move independently, utility lines shall be provided with adequate flexibility to accommodate the anticipated differential movement between the ground and the structure. Differential displacements shall be determined in accordance with Sec. 6.2.7.

The possible interruption of utility service shall be considered in relation to designated seismic systems in Seismic Use Group III, as defined in Sec. 1.2.1. Specific attention shall be given to the vulnerability of underground utilities and utility interfaces between the structure and the ground in all situations where the assigned Site Class is E or F and S_{DS} is greater than or equal to 0.4.

6.4.6 HVAC ductwork. Seismic restraints are not required for HVAC ducts with I_p equal to 1.0 if either of the following conditions is met for the full length of each duct run:

1. HVAC ducts are suspended from hangers, all hangers are 12 in. (305 mm) or less in length as measured from the point of attachment to the duct to the point of attachment on the supporting structure and the hangers are detailed to avoid significant bending of the hangers and their attachments; or
2. HVAC ducts have a cross-sectional area of less than 6 ft² (0.6 m²).

HVAC duct systems fabricated and installed in accordance with SMACNA 80, SMACNA 95, and SMACNA 98 shall be deemed to satisfy the seismic bracing requirements of these *Provisions*.

Components that are installed in-line with the duct system and have an operating weight greater than 75 lb (334 N), such as fans, heat exchangers, and humidifiers, shall be supported and laterally braced independently of the duct system and such braces shall be designed for the seismic forces defined in Sec. 6.2.6. Appurtenances, such as dampers, louvers, and diffusers, shall be positively attached with mechanical fasteners. Unbraced piping attached to in-line equipment shall be provided with adequate flexibility to accommodate differential displacements.

6.4.7 Piping systems. Piping systems shall satisfy the requirements of this section except that elevator system piping shall satisfy the requirements of Sec. 6.4.9.

6.4.7.1 Fire protection sprinkler systems. Fire protection sprinkler systems shall be designed and constructed in accordance with NFPA-13. Fire protection sprinkler systems in Seismic Design Category C designed and constructed in accordance with NFPA-13 shall be deemed to satisfy the seismic force and relative displacement requirements of these *Provisions*.

In Seismic Design Categories D, E and F, fire protection sprinkler systems designed and constructed in accordance with NFPA-13 shall meet the following additional criteria:

6.4.7.1.1 The spacing of longitudinal sway bracing and transverse sway bracing specified in NFPA 13 Section 9.3.5 shall be reduced by multiplying the maximum brace spacing permitted in NFPA 13 Section 9.3.5 by $0.8W_p / F_p$. The value of $0.8W_p / F_p$ shall not be taken as greater than 1.0.

6.4.7.2 Other piping systems. Where the seismic design forces and displacements specified in ASME B31.1, ASME B31.3, ASME B31.4, ASME B31.5, ASME B31.8, ASME B31.9, and ASME B31.11 are comparable to those determined using these *Provisions*, the use of these standards for seismic design of piping systems shall be permitted.

Exception: Piping systems with I_p greater than 1.0 shall not be designed using the simplified analysis procedures found in Sec. 919.4.1 (a) of ASME B31.9.

Piping systems with I_p greater than 1.0 also shall satisfy the following requirements:

1. Under design loads and displacements, piping shall not be permitted to impact other components.
2. Piping shall accommodate the effects of relative displacements that may occur between piping support points on the structure or the ground and other mechanical or electrical equipment or other piping.

Seismic supports for other piping shall be constructed so that support engagement is maintained, and attachments shall be designed in accordance with Sec. 6.2.8.

Seismic supports are not required for other piping systems where one of the following conditions is met:

1. Piping is supported by rod hangers, all hangers in the pipe run are 12 in. (305 mm) or less in length from the top of the pipe to the supporting structure, the hangers are detailed to avoid bending of the hangers and their attachments, and the pipe can accommodate the expected deflections; or
2. High deformability piping is used, provision is made to avoid impact with larger piping or mechanical components or to protect the piping in the event of such impact, and the following size requirements are satisfied:
 - a. In Seismic Design Category D, E, or F, where I_p is greater than 1.0, the nominal pipe size shall be 1 in. (25 mm) or less,
 - b. In Seismic Design Category C, where I_p is greater than 1.0, the nominal pipe size shall be 2 in. (51 mm) or less, and
 - c. In Seismic Design Category D, E, or F, where I_p is equal to 1.0, the nominal pipe size shall be 3 in. (76 mm) or less.

6.4.8 Boilers and pressure vessels. Boilers and pressure vessels designed in accordance with ASME BPV shall be deemed to satisfy the seismic force and relative displacement requirements of these *Provisions* provided that the forces and displacements defined in Sec. 6.2.6 and 6.2.7 are used in lieu of the seismic forces and displacements defined in ASME BPV. Supports and attachments for boilers and pressure vessels are still subject to the requirements of these *Provisions*.

6.4.9 Elevators. Elevators designed in accordance with the seismic provisions of ASME A17.1 shall be deemed to satisfy the requirements of this chapter except that they also shall satisfy the additional requirements of this section.

6.4.9.1 Elevators and hoistway structural systems. Elevators and hoistway structural systems shall be designed for the seismic forces and relative displacements defined in Sec. 6.2.6 and 6.2.7.

6.4.9.2 Elevator machinery and controller supports and attachments. Supports and attachments for elevator machinery and controllers shall be designed for the seismic forces and relative displacements defined in Sec. 6.2.6 and 6.2.7.

6.4.9.3 Seismic switches. Seismic switches shall be provided for all elevators that operate with a speed of 150 ft/min (46 m/min) or greater, including those which satisfy the requirements of ASME A17.1.

Seismic switches shall provide an electrical signal indicating that structural motions are of such a magnitude that the operation of elevators may be impaired. The seismic switch shall be located at or above the highest floor serviced by the elevator. The seismic switch shall have two horizontal perpendicular axes of sensitivity. Its trigger level shall be set to 30 percent of the acceleration of gravity in facilities where the loss of the use of an elevator is a life-safety issue.

Upon activation of the seismic switch, elevator operations shall comply with the provisions of ASME A17.1. The elevator may be used after the seismic switch has triggered provided that:

1. The elevator shall operate no faster than the service speed,
2. The elevator shall be operated remotely from top to bottom and back to top to verify that it is operable, and

3. The individual putting the elevator back in service shall ride the elevator from top to bottom and back to top to verify acceptable performance.

6.4.9.4 Retainer plates. Retainer plates are required at the top and bottom of the car and counterweight.

Appendix to Chapter 6

ALTERNATIVE PROVISIONS FOR THE DESIGN OF PIPING SYSTEMS

BACKGROUND: As currently written, the Provisions do not recognize discrete levels of performance that may be relevant to the seismic design of piping systems, particularly for essential facilities. This Appendix provides preliminary criteria for the establishment of such performance criteria and their use in the assessment and design of piping systems. The performance criteria, from least restrictive to most severe, are: position retention, leak tightness and operability. In particular, the interaction of systems and interface with the relevant piping design standards is addressed.

A6.1 DEFINITIONS

Leak Tightness: The condition of a piping system characterized by containment of contents, or maintenance of a vacuum, with no discernable leakage.

Operability: The condition of a piping system characterized by leak tightness as well as continued delivery, shutoff or throttle of pipe contents flow by means of unimpaired operation of equipment and components such as pumps, compressors and valves.

Position Retention: The condition of a piping system characterized by the absence of collapse or fall of any part of the system.

A6.2 DESIGN APPROACH

The seismic design of piping systems is determined on the basis of Seismic Design Category, I_p , and pipe size, as provided in Table A6.2-1. For each case in table A6.2-1, the procedure for seismic qualification is specified in Sec.A.6.5.

Where $I_p = 1.0$, the piping system is not critical and is required to maintain position retention.

Where $I_p = 1.5$, the piping system is critical and is required to exhibit leak tightness and may be required to maintain operability.

Table A6.2-1 Seismic Design Requirements

Seismic Design Category	$I_p = 1.0$		$I_p = 1.5$	
	Pipe Size \leq 4 inch (SI: 102 mm)	Pipe Size $>$ 4 inch (SI: 102 mm)	Pipe Size \leq 4 inch (SI: 102 mm)	Pipe Size $>$ 4 inch (SI: 102 mm)
B	Interactions (A6.5.2.1)	Interactions (A6.5.2.1)	Bracing (A6.5.2.2) Restraints (A6.5.2.3) Operability ^a (A6.5.2.4) Interactions (A6.5.2.1)	Bracing (A6.5.2.2) Restraints (A6.5.2.3) Operability ^a (A6.5.2.4) Interactions (A6.5.2.1)
C or D	Interactions (A6.5.2.1)	Interactions (A6.5.2.1)	Bracing (A6.5.2.2) Restraints (A6.5.2.3) Operability ^a (A6.5.2.4) Interactions (A6.5.4.2.1)	Analysis (A6.5.2.5) Restraints (A6.5.2.3) Operability ^a (A6.5.2.4) Interactions (A6.5.2.1)
E or F	Bracing (A6.5.2.2) Restraints (A6.5.2.3) Interactions (A6.5.2.1)	Bracing (A6.5.2.2) Restraints (A6.5.2.3) Operability ^a (A6.5.2.4) Interactions (A6.5.2.1)	Analysis (A6.5.2.5) Restraints (A6.5.2.3) Operability ^a (A6.5.2.4) Interactions (A6.5.2.1)	Analysis (A6.5.2.5) Restraints (A6.5.2.3) Operability ^a (A6.5.2.4) Interactions (A6.5.2.1)

^a Leak tightness is the default requirement. Operability applies only where specified by design.

A6.3 SYSTEM COEFFICIENTS

A6.3.1 Deformability. Piping systems shall be classified as either high-, limited-, or low-deformability systems.

All materials in high-deformability piping systems shall have an elongation at rupture of at least 10 percent at the operating temperature, and pipes and pipe components used in high-deformability systems shall be joined by welding or by bolted flanges.

Systems containing components with an elongation at rupture of less than 10 percent at the operating temperature, or having joints that rely only on friction, shall be classified as low-deformability systems.

Systems that are neither high- nor low-deformability systems shall be classified as limited deformability systems. Systems with threaded connections shall be classified as limited- or low-deformability systems.

A6.3.2 Seismic Coefficients. The seismic coefficients a_p and R_p are specified in Table 6.4.1 for high-, limited-, and low-deformability piping systems.

A6.4 SEISMIC DEMAND

A6.4.1 Seismic demand on a piping system consists of applied forces and relative displacements.

A6.4.2 Seismic forces shall be determined as specified in Sec. 6.2.6.

A6.4.3 Seismic relative displacements at points of attachments of pipe restraints to the structure shall be determined as specified in Sec. 6.2.7.

A6.5 SEISMIC QUALIFICATION

A6.5.1 Elevator system piping shall satisfy the provisions of Sec.6.4.9. ASME B31 pressure piping systems shall satisfy the provisions of the applicable ASME B31 code section. Fire sprinkler systems shall satisfy the provisions of Sec.A6.5.2.6.

A6.5.2 The seismic qualification of piping systems depends on the Design Approach selected in A6.2.

A6.5.2.1 Where interactions are specified they shall be evaluated in accordance with Sec.6.2.3.

A6.5.2.2 Where bracing is specified, the pipe must be seismically restrained. Lateral restraints shall be provided (a) to limit the bending stress in the pipe to yield at the operating temperature and (b) to limit the rotations at articulated joints within the manufacturer limits. Unlike analysis (Sec. A6.5.2.5), bracing does not require a detailed analysis of the piping system; the distance between seismic restraints may be established based on beam approximations of the pipe spans. The effect of seismic restrains on operating loads (thermal expansion and contraction, weight) shall be considered.

A6.5.2.3 Where restraints are specified, the pipe seismic restraints as well as their welds and anchorage attachment to the structure shall comply with the provisions of Chapters 8 to 12. Supports shall be constructed so that support engagement is maintained considering both lateral and vertical seismic forces.

A6.5.2.4 Where operability is specified, the equipment and components that must perform an active function that involves moving parts (such as pumps, compressors, fans and valve operators) shall comply with the requirements of Sec.2.4.5.

A6.5.2.5 Where analysis is specified, the piping system shall be analyzed by static or dynamic methods. The maximum calculated elastic stress due to the earthquake loads and concurrent weight and pressure shall be limited to $1.5S_Y$ (where S_Y is the minimum specified material yield stress at normal operating temperature) and the rotations at articulated joints shall be within the manufacturer limits. The analysis shall include the effects of stress intensification factors as determined in the ASME B31 pressure piping code, and corrosion effects.

A6.5.2.6 Fire protection sprinkler systems shall meet the following requirements:

A6.5.2.6.1 Fire protection sprinkler systems in Seismic Design Categories A, B and C designed and constructed in accordance with NFPA-13 shall be deemed to satisfy the seismic force and relative displacement requirements of these *Provisions*.

A6.5.2.6.2 In Seismic Design Categories D, E and F, fire protection sprinkler systems designed and constructed in accordance with NFPA 13 shall also meet the following additional criteria:

1. The spacing of longitudinal sway bracing and transverse sway bracing specified in NFPA 13 Sec. 9.3.5 shall be reduced by multiplying the maximum brace spacing permitted in NFPA 13 Sec. 9.3.5 by $0.8W_p / F_p$. The value of $0.8W_p / F_p$ shall not be taken as greater than 1.0.

This page is intentionally left blank.

Chapter 7

FOUNDATION DESIGN REQUIREMENTS

7.1 GENERAL

7.1.1 Scope. This chapter includes only those foundation requirements that are specifically related to seismic resistant construction. It assumes compliance with all other basic requirements which include, but are not limited to, requirements for the extent of the foundation investigation, fills to be present or to be placed in the area of the structure, slope stability, subsurface drainage, settlement control, and soil bearing and lateral soil pressure recommendations for loads acting without seismic forces.

7.1.2 References. The following document shall be used as specified in this chapter.

ACI 318 *Building Code Requirements for Structural Concrete*, American Concrete Institute, 2002.

AISC-Seismic *Seismic Provisions For Structural Steel Buildings*, American Institute of Steel Construction May 21, 2002

7.1.3 Definitions.

Basement: Any story below the lowest story above grade.

Component: See Sec. 1.1.4.

Design earthquake ground motion: See Sec. 1.1.4.

Design strength: See Sec. 4.1.3.

Longitudinal reinforcement ratio: Area of the longitudinal reinforcement divided by the cross-sectional area of the concrete.

Nominal strength: See Sec. 4.1.3.

Owner: See Sec. 1.1.4.

Pile: Deep foundation components including piers, caissons, and piles.

Pile cap: Foundation elements to which piles are connected, including grade beams and mats.

Reinforced concrete: See Sec. 9.1.3.

Required strength: See Sec. 4.1.3.

Seismic Design Category: See Sec. 1.1.4.

Seismic forces: See Sec. 1.1.4.

Site Class: See Sec. 3.1.3.

Structure: See Sec. 1.1.4.

Wall: See Sec. 4.1.3.

7.1.4 Notation

A_{ch} Cross sectional-area of a component measured to the outside of the special lateral reinforcement.

A_g Gross cross sectional-area of a component.

f'_c Specified compressive strength of concrete used in design.

f_{yh}	Specified yield stress of the special lateral reinforcement.
h_c	The core dimension of a component measured to the outside of the special lateral reinforcement.
P	Axial load on pile calculated in accordance with Sec. 4.2.2.
S_{DS}	See Sec. 3.1.4.
s	Spacing of transverse reinforcement measured along the length of an element.

7.2 GENERAL DESIGN REQUIREMENTS

The resisting capacities of the foundations, subjected to the load combinations prescribed elsewhere in these *Provisions*, shall meet the requirements of this chapter.

7.2.1 Foundation components. The strength and detailing of foundation components under seismic loading conditions, including foundation elements and attachments of the foundation elements to the superstructure, shall comply with the requirements of Chapters 8, 9, 10, 11, or 12, unless otherwise specified in this chapter. The strength of foundation components shall not be less than that required for load combinations that do not include seismic load effects.

7.2.2 Soil capacities. The capacity of the foundation soil in bearing or the capacity of the interface between pile, pier, or caisson and the soil shall be sufficient to support the structure with all prescribed loads, without seismic forces, taking due account of the settlement that the structure can withstand. For the load combinations including seismic load effects as specified in Sec. 4.2.2, the soil capacities must be sufficient to resist loads at acceptable strains considering both the short duration of loading and the dynamic properties of the soil.

7.2.3. Foundation load-deformation characteristics. Where permitted for the linear analysis procedures in Chapter 5, the load-deformation characteristics of the foundation-soil system (foundation stiffness) shall be modeled in accordance with the requirements of this section. The linear load-deformation behavior of foundations shall be represented by an equivalent linear stiffness using soil properties that are compatible with the soil strain levels associated with the design earthquake motion. The strain-compatible shear modulus, G , and the associated strain-compatible shear wave velocity, v_s , needed for the evaluation of equivalent linear stiffness shall be determined using the criteria in Sec. 5.6.2.1.1 or based on a site-specific study. Parametric variations of not less than 50% increase and decrease in stiffness shall be incorporated in dynamic analyses unless smaller variations can be justified based on field measurements of dynamic soil properties or direct measurements of dynamic foundation stiffness.

7.3 SEISMIC DESIGN CATEGORY B

Any construction meeting the requirements of Sec. 7.1 and 7.2 is permitted to be used for structures assigned to Seismic Design Category B.

7.4 SEISMIC DESIGN CATEGORY C

Foundations for structures assigned to Seismic Design Category C shall comply with Sec. 7.3 and the additional requirements of this section.

7.4.1 Investigation. An investigation shall be conducted and a written report shall be provided that shall include, in addition to the requirements of Sec. 7.1 and the evaluations required in Sec. 7.2.2, the results of an investigation to determine the potential hazards due to slope instability, liquefaction, differential settlement, and surface displacement due to faulting or lateral spreading, all as a result of earthquakes. The report shall contain recommendations for appropriate foundation designs or other measures to mitigate the effects of the above hazards. Where deemed appropriate by the authority having jurisdiction, a report is not required when prior evaluations of nearby sites with similar soil conditions provide sufficient direction relative to the proposed construction.

7.4.2 Pole-type structures. Construction employing posts or poles as columns embedded in earth or embedded in concrete footings in the earth are permitted to be used to resist both axial and lateral loads. The depth of embedment required for posts or poles to resist seismic forces shall be determined by means of the design criteria established in the foundation investigation report.

7.4.3 Foundation ties. Individual pile caps, drilled piers, or caissons shall be interconnected by ties. All ties shall be capable of carrying, in tension or compression, a force equal to the product of the larger pile cap or column load times S_{DS} divided by 10 unless it can be demonstrated that equivalent restraint can be provided by reinforced concrete beams within slabs on grade or reinforced concrete slabs on grade or confinement by competent rock, hard cohesive soils, very dense granular soils, or other approved means.

7.4.4 Special pile requirements. The following special requirements for piles, piers, or caissons are in addition to all other requirements in the code administered by the authority having jurisdiction.

All concrete piles and concrete filled pipe piles shall be connected to the pile cap by embedding the pile reinforcement in the pile cap for a distance equal to the development length as specified in ACI 318 as modified by Chapter 9 of these *Provisions*. The pile cap connection can be made by the use of field-placed dowel(s) anchored in the concrete pile. For deformed bars, the development length is the full development length for compression or tension, in the case of uplift, without reduction in length for excess area.

Ends of rectangular hoops, spirals, and ties shall be terminated with seismic hooks as defined in Sec. 21.1 of ACI 318 turned into the confined concrete core. The ends of circular spirals and hoops shall be terminated with 90-degree hooks turned into the confined concrete core.

For resistance to uplift forces, anchorage of steel pipe (or round HSS), concrete filled steel pipe, or H piles to the pile cap shall be made by means other than concrete bond to the bare steel section.

Exception: Anchorage of concrete filled steel pipe piles is permitted to be accomplished using deformed bars developed into the concrete portion of the pile.

Where a minimum length for reinforcement or the extent of closely spaced confinement reinforcement is specified at the top of the pile, provisions shall be made so that those specified lengths or extents are maintained after pile cut-off.

7.4.4.1 Uncased concrete piles. The longitudinal reinforcement ratio for uncased cast-in-place concrete drilled or augered piles, piers, or caissons shall not be less than 0.0025 throughout the largest region defined as follows: the top one-third of the pile length, the top 10 ft (3 m) below the ground, or the flexural length of the pile. The flexural length shall be taken as the length from the top of the pile to the lowest point where the calculated flexural demand exceeds 0.4 times the concrete section cracking moment. The longitudinal reinforcing shall extend beyond the flexural length of the pile by the tension development length. Longitudinal reinforcement shall consist of at least four bars and shall be confined with closed ties or equivalent spirals with a diameter of not less than 3/8 in. (9.5 mm) and spaced not more than 16 times the diameter of the smallest longitudinal bar. Within three pile diameters of the bottom of the pile cap, transverse confinement reinforcing shall be spaced not more than the lesser of eight times the diameter of the smallest longitudinal bar or 6 in. (150 mm).

7.4.4.2 Metal-cased concrete piles. Reinforcement requirements are the same as for uncased concrete piles.

Exception: Spiral welded metal casing of a thickness not less than No. 14 gauge may be considered to provide concrete confinement equivalent to the closed ties or equivalent spirals required in an uncased concrete pile, provided that the metal casing is adequately protected against possible deleterious action due to soil constituents, changing water levels, or other factors indicated by boring records of site conditions.

7.4.4.3 Concrete-filled pipe. The longitudinal reinforcement ratio at the top of the pile shall not be less than 0.01 and such reinforcement shall extend into the pile at least two times the length required for embedment into the pile cap.

7.4.4.4 Precast (non-prestressed) concrete piles. The longitudinal reinforcement ratio for precast concrete piles shall not be less than 0.01. Longitudinal reinforcement shall be full length and shall be confined with closed ties or equivalent spirals with a diameter of not less than 3/8 in. (9.5mm) and spaced not more than the lesser of 16 times the diameter of the smallest longitudinal bar or 8 in. (200 mm). Within three pile diameters of the bottom of the pile cap, transverse confinement reinforcing shall be spaced not more than the lesser of eight times the diameter of the smallest longitudinal bar or 6 in. (152 mm).

7.4.4.5 Precast-prestressed piles. Transverse reinforcement shall consist of circular hoops or spirals. For the upper 20 ft (6 m) of the pile, the volumetric ratio of transverse reinforcement shall not be less than the larger of 0.007 or that required by Eq. 7.4-1 as follows:

$$\rho_s = 0.12 \frac{f'_c}{f_{yh}} \quad (7.4-1)$$

Where:

ρ_s = volumetric ratio of transverse reinforcement (volume of transverse reinforcement divided by volume of enclosed core),

f'_c = specified compressive strength of concrete, psi (Mpa), and

f_{yh} = yield strength of transverse reinforcement, which shall not be taken greater than 85,000 psi (586 MPa).

Below the 20 ft (6 m) point, the amount of transverse reinforcement shall not be less than one-half that required by Eq. 7.4-1.

7.5 SEISMIC DESIGN CATEGORIES D, E, AND F

Foundations for structures assigned to Seismic Design Category D, E, or F shall comply with Sec. 7.4 and the additional requirements of this section. Concrete foundation components shall be designed and constructed in accordance with Sec. 21.8 of ACI 318, except as modified by the requirements of this section.

Exception: Detached one- and two-family dwellings of light-frame construction not exceeding two stories in height above grade need only comply with the requirements for Sec.7.4 and Sec. 7.5.3.

7.5.1 Investigation. In addition to requirements of Sec. 7.4.1, the investigation and report shall include the determination of lateral pressures on basement and retaining walls due to earthquake motions.

7.5.2 Liquefaction potential and soil strength loss. The geotechnical report shall describe the likelihood and potential consequences of liquefaction and soil strength loss (including estimates of differential settlement, lateral movement, lateral loads on foundations, reduction in foundation soil-bearing capacity, increases in lateral pressures on retaining walls, and flotation of embedded structures) and shall discuss mitigation measures. Such measures shall be given consideration in the design of the structure and can include, but are not limited to, ground stabilization, selection of appropriate foundation type and depths, selection of appropriate structural systems to accommodate anticipated displacements and forces, or any combination of these measures.

The potential for liquefaction and soil strength loss shall be evaluated for site peak ground accelerations, magnitudes, and source characteristics consistent with the design earthquake ground motions. Peak ground acceleration is permitted to be determined based on a site-specific study taking into account soil

amplification effects or, in the absence of such a study, peak ground accelerations shall be assumed equal to $S_{DS}/2.5$.

7.5.3 Foundation ties. Individual spread footings founded on soil assigned to Site Class E or F shall be interconnected by ties designed in accordance with Sec. 7.4.3.

7.5.4 Special pile and grade beam requirements. Piling shall be designed and constructed to withstand the maximum curvatures resulting from earthquake ground motions and structural response. Curvatures shall include the effects of free-field soil strains (without the structure), modified for soil-pile interaction, coupled with pile deformations induced by lateral pile resistance to structure seismic forces. Concrete piles in Site Class E or F shall be designed and detailed in accordance with Sec. 21.4.4.1, 21.4.4.2, and 21.4.4.3 of ACI 318 within seven pile diameters of the pile cap and of the interfaces between strata that are hard or stiff and strata that are liquefiable or are composed of soft to medium-stiff clay.

Section 21.10.3.3 of ACI 318 need not apply where grade beams have the required strength to resist the forces from the load combinations of Section 4.2.2.2. Section 21.10.4.4(a) of ACI 318 need not apply to concrete piles.

Design of anchorage of piles into the pile cap shall consider the combined effect of axial forces due to uplift and bending moments due to fixity to the pile cap. For piles required to resist uplift forces or provide rotational restraint, anchorage into the pile cap shall be capable of developing the following:

1. In the case of uplift, the least of: the nominal tensile strength of the longitudinal reinforcement in a concrete pile, the nominal tensile strength of a steel pile, the nominal uplift strength of the soil-pile interface times 1.3, or the axial tension force calculated in accordance with Sec. 4.2.2.2. The nominal uplift strength of the soil-pile interface shall be taken as the ultimate frictional or adhesive force that can be developed between the soil and the pile.
2. In the case of rotational restraint, the lesser of: the load effects (axial forces, shear forces, and moments) calculated in accordance with Sec. 4.2.2.2, or development of the nominal axial, bending, and shear strength of the pile.

Splices of pile segments shall be capable of developing the lesser of: the nominal strength of the pile section, or the axial forces, shear forces, and moments calculated in accordance with Sec. 4.2.2.2.

Pile moments, shears, and lateral deflections used for design shall be established considering the interaction of the pile and soil. Where the ratio of the depth of embedment of the pile to the pile diameter or width is less than or equal to 6, the pile may be assumed to be flexurally rigid with respect to the soil.

Where the center-to-center spacing of piles in the direction of the lateral force is less than eight pile diameters, the effects of such spacing on the lateral response of the piles shall be included. Where the center-to-center spacing of piles is less than three pile diameters, the effects of such spacing on the vertical response of the piles shall be included.

Batter piles shall be capable of resisting forces and moments calculated in accordance with Sec. 4.2.2.2.

Where vertical and batter piles act jointly to resist foundation forces as a group, these forces shall be distributed to the individual piles in accordance with their relative horizontal and vertical rigidities and the geometric distribution of the piles within the group. The connection between batter piles and grade beams or pile caps shall be capable of developing the nominal strength of the pile acting as a short column.

7.5.4.1 Uncased concrete piles. The longitudinal reinforcement ratio for uncased cast-in-place concrete drilled or augered piles, piers, or caissons shall not be less than 0.005 throughout the largest region defined as follows: the top one-half of the pile length, the top 10 ft (3 m) below the ground, or the flexural length of the pile. The flexural length shall be taken as the length of pile to a point where 0.4 times the concrete section cracking moment exceeds the calculated flexural demand at that point.

Longitudinal reinforcement shall consist of at least four bars and shall be confined with closed ties or equivalent spirals at a spacing of not more than the least of: 12 times the diameter of the smallest longitudinal bar, one-half the diameter of the section, or 12 in. (300 mm). Ties shall have a diameter of not less than 3/8 in. (9.5 mm) where the pile diameter is less than or equal to 20 in. (500 mm) and not less than 1/2 in. (12.7 mm) for piles of larger diameter. Within three pile diameters of the bottom of the pile cap, transverse confinement reinforcing shall satisfy Sec. 21.4.4.1, 21.4.4.2, and 21.4.4.3 of ACI 318. Where the assigned Site Class is A, B, C, or D and the soil is not subject to liquefaction, it shall be permitted to use a transverse spiral reinforcing ratio of not less than one-half of that required in Sec. 21.4.4.1(a) of ACI 318.

7.5.4.2 Metal-cased concrete piles. Reinforcement requirements are the same as for uncased concrete piles.

Exception: Spiral welded metal-casing of a thickness not less than No. 14 gauge may be considered to provide concrete confinement equivalent to the closed ties or equivalent spirals required in an uncased concrete pile, provided that the metal casing is adequately protected against possible deleterious action due to soil constituents, changing water levels, or other factors indicated by boring records of site conditions.

7.5.4.3 Precast (non-prestressed) concrete piles. Within three pile diameters of the bottom of the pile cap, transverse confinement reinforcing shall satisfy Sec. 21.4.4.1, 21.4.4.2, and 21.4.4.3 of ACI 318. Where the assigned Site Class is A, B, C, or D and the soil is not subject to liquefaction, it shall be permitted to use a transverse spiral reinforcing ratio of not less than one-half of that required in Sec. 21.4.4.1(a) of ACI 318.

7.5.4.4 Precast-prestressed piles. The requirements of ACI 318 need not apply, unless specifically referenced.

Where the total pile length in the soil is 35 ft (11 m) or less, transverse confinement reinforcement shall be provided throughout the length of the pile. Where the pile length exceeds 35 ft (11 m), transverse confinement reinforcement shall be provided throughout the largest region defined as follows: the top 35 ft (11 m) below the ground, or the distance from the underside of the pile cap to the first point of zero curvature plus three times the least pile dimension. The transverse confinement reinforcement shall be spiral or hoop reinforcement with a center-to-center spacing not greater than the least of: one-fifth of the least pile dimension, six times the diameter of the longitudinal tendons, or 8 in. (200 mm).

Where the transverse confinement reinforcement consists of spirals or circular hoops, the volumetric ratio of transverse reinforcement shall not be less than that required by Eq. 7.5-1 and 7.5-2, but need not exceed 0.021.

$$\rho_s = 0.25 \left(\frac{f'_c}{f_{yh}} \right) \left(\frac{A_g}{A_{ch}} - 1 \right) \left(0.5 + \frac{1.4P}{f'_c A_g} \right) \quad (7.5-1)$$

$$\rho_s = 0.12 \left(\frac{f'_c}{f_{yh}} \right) \left(0.5 + \frac{1.4P}{f'_c A_g} \right) \quad (7.5-2)$$

where:

ρ_s = volumetric ratio of transverse reinforcement (volume of transverse reinforcement divided by volume of enclosed core),

f'_c = specified compressive strength of concrete,

f_{yh} = yield strength of transverse reinforcement, which shall not be taken greater than 85,000 psi (586 MPa),

A_g = pile cross-sectional area,

A_{ch} = core area defined by outside diameter of the transverse reinforcement, and

P = axial load on pile calculated in accordance with Sec. 4.2.2.

Where the transverse confinement reinforcement consists of rectangular hoops and cross ties, the total cross-sectional area of transverse reinforcement shall not be less than that required by Eq. 7.5-3 and 7.5-4.

$$A_{sh} = 0.3sh_c \left(\frac{f'_c}{f_{yh}} \right) \left(\frac{A_g}{A_{ch}} - 1 \right) \left(0.5 + \frac{1.4P}{f'_c A_g} \right) \quad (7.5-3)$$

$$A_{sh} = 0.12sh_c \left(\frac{f'_c}{f_{yh}} \right) \left(0.5 + \frac{1.4P}{f'_c A_g} \right) \quad (7.5-4)$$

where:

s = spacing of transverse reinforcement measured along length of pile,

h_c = cross-sectional dimension of pile core measured center-to-center of hoop reinforcement,

f'_c = specified compressive strength of concrete, and

f_{yh} = yield strength of transverse confinement reinforcement, which shall not be taken greater than 70,000 psi (483 Mpa).

Outside of the length of the pile requiring transverse confinement reinforcement, spiral or hoop reinforcement with a volumetric ratio not less than one-half of that required for transverse confinement reinforcement shall be provided.

Circular spiral reinforcement shall be spliced by lapping one full turn and bending the end of the spiral to a 90-degree hook or by use of a mechanical or welded splice complying with Sec. 12.14.3 of ACI 318. The required amount of spiral reinforcement shall be permitted to be obtained by providing an inner and outer spiral.

Hoops and cross ties shall have a diameter of not less than 3/8 in. (9.5 mm). Rectangular hoop ends shall terminate at a corner with seismic hooks.

7.5.4.5 Steel Piles. Design and detailing of H-piles shall conform to the provisions of AISC Seismic and the following. The connection between steel piles (including unfilled steel pipe piles) and pile caps shall be designed for a tensile force no smaller than 10 percent of the nominal compression strength of the pile.

Exception: The pile connection need not meet this requirement where it can be demonstrated that the pile connection has the strength to resist the axial forces and moments calculated in accordance with Sec. 4.2.2.2.

This page is intentionally left blank.

Appendix to Chapter 7

GEOTECHNICAL ULTIMATE STRENGTH DESIGN OF FOUNDATIONS AND FOUNDATION LOAD-DEFORMATION MODELING

PREFACE: This appendix introduces ultimate strength design (USD) procedures for the geotechnical design of foundations for trial use and evaluation by design professionals prior to adoption into a subsequent edition of the *Provisions*. Similarly, the appendix also introduces criteria for the modeling of load-deformation characteristics of the foundation-soil system (foundation stiffness) for those analysis procedures in Chapter 5 that permit the use of realistic assumptions for foundation stiffness rather than the assumption of a fixed base.

Current practice for geotechnical foundation design is based on allowable stresses with allowable foundation load capacities for dead plus live loads based on limiting long-term static settlements and providing a large factor of safety. In current practice, allowable soil stresses for dead plus live loads are typically increased by one-third for load combinations that include wind or seismic forces. The allowable stresses for dead plus live loads are often far below ultimate soil capacity. This *Provisions* appendix and the associated *Commentary* appendix provide criteria and guidance for the direct use of ultimate foundation load capacity for load combinations that include seismic forces. The acceptance criteria covers both the analyses for fixed-base assumptions and analyses for linear and nonlinear modeling of foundation stiffness for flexible-base assumptions.

Although USD for foundations has not previously been included in design provisions for new buildings, the same basic principles used in this appendix have been adapted to generate guidelines for the seismic evaluation and retrofit design of existing buildings (FEMA 273, FEMA 356, and ATC 40). The criteria and procedures presented herein for the nonlinear modeling of foundation stiffness, combining a linear or multilinear stiffness and a limiting load capacity based on ultimate soil strength, are essentially the same as those presented in the FEMA and ATC publications identified above.

With respect to the adoption of USD procedures for geotechnical foundation design, the primary issue considered by the Provision Update Committee and the BSSC member organizations has been the impact of the proposed USD procedures on the size of foundations and consequent effect on the potential for foundation rocking and building performance. TS3 has conducted a limited number of design examples, a synopsis of which is presented at the end of the Commentary for the Appendix to Chapter 7. The example results illustrate the expected effects of the methodology, in that relative foundation sizes from USD vs ASD are related to the factor of safety on load capacity under vertical dead plus live loads. When factors of safety are high, smaller foundations result from USD, but when factors of safety are low, it is possible that foundations may be larger using USD. Additional examples, including nonlinear dynamic analyses incorporating nonlinear load-deformation models for foundation soil stiffness and capacity, are warranted to further evaluate and possibly refine the methodology and criteria. It is hoped that trial usage of the methodologies presented herein will allow the necessary consensus to be developed to permit later incorporation into the *Provisions*. Please direct feed-back on this appendix and its commentary to the BSSC.

A7.1 GENERAL

A7.1.1 Scope. This appendix includes only those foundation requirements that are specifically related to seismic resistant construction. It assumes compliance with all other basic requirements which include, but are not limited to, requirements for the extent of the foundation investigation, fills to be present or to be placed in the area of the structure, slope stability, subsurface drainage, settlement

control, and soil bearing and lateral soil pressure recommendations for loads acting without seismic forces.

A7.1.2 Definitions

Allowable foundation load capacity: See Sec. A 7.2.2.

Ultimate foundation load capacity: See Sec. A 7.2.2.

A7.1.3 Notation

Q_{as} Allowable foundation load capacity.

Q_{us} Ultimate foundation load capacity.

ϕ The strength reduction, capacity reduction, or resistance factor.

A7.2 GENERAL DESIGN REQUIREMENTS

The resisting capacities of the foundations, subjected to the load combinations prescribed elsewhere in these *Provisions*, shall meet the requirements of this appendix.

A7.2.1 Foundation components. The strength and detailing of foundation components under seismic loading conditions, including foundation elements and attachments of the foundation elements to the superstructure, shall comply with the requirements of Chapters 8, 9, 10, 11, or 12, unless otherwise specified in this chapter. The strength of foundation components shall not be less than that required for load combinations that do not include seismic load effects.

A7.2.2. Foundation load capacities. The vertical capacity of foundations (footings, piles, piers, mats or caissons) as limited by the soil shall be sufficient to support the structure for all prescribed load combinations without seismic forces, taking into account the settlement that the structure can withstand while providing an adequate factor of safety against failure. Such capacities are defined as allowable foundation load capacities, Q_{as} . For load combinations including seismic load effects as specified in Sec. 4.2.2, vertical, lateral, and rocking load capacities of foundations as limited by the soil shall be sufficient to resist loads with acceptable deformations, considering the short duration of loading, the dynamic properties of the soil, and the ultimate load capacities, Q_{us} , of the foundations under vertical, lateral, and rocking loading.

A7.2.2.1 Determination of ultimate foundation load capacities. Ultimate foundation load capacities shall be determined by a qualified geotechnical engineer based on geotechnical site investigations that include field and laboratory testing to determine soil classification and soil strength parameters, and/or capacities based on insitu testing of prototype foundations. For competent soils that do not undergo strength degradation under seismic loading, strength parameters for static loading conditions shall be used to compute ultimate load capacities for seismic design. For sensitive cohesive soils or saturated cohesionless soils, the potential for earthquake induced strength degradation shall be considered.

Ultimate foundation load capacities, Q_{us} , under vertical, lateral, and rocking loading shall be determined using accepted foundation design procedures and principles of plastic analysis. Calculated ultimate load capacities, Q_{us} , shall be best-estimated values using soil properties that are representative average values for individual foundations. Best-estimated values of Q_{us} shall be reduced by resistance factors (ϕ) to reflect uncertainties in site conditions and in the reliability of analysis methods. The factored foundation load capacity, ϕQ_{us} , shall then be used to check acceptance criteria, and as the foundation capacity in foundation nonlinear load-deformation models.

If ultimate foundation load capacities are determined based on geotechnical site investigations including laboratory or in-situ tests, ϕ -factors equal to 0.8 for cohesive soils and 0.7 for cohesionless soils shall be used for vertical, lateral, and rocking resistance for all foundation types. If ultimate

foundation load capacities are determined based on full-scale field-testing of prototype foundations, ϕ -factors equal to 1.0 for cohesive soils and 0.9 for cohesionless soils are permitted.

A7.2.2.2 Acceptance criteria. For linear analysis procedures (Sec. 5.2, 5.3, and 5.4), factored foundation load capacities, ϕQ_{us} , shall not be exceeded for load combinations that include seismic load effects.

For the nonlinear response history procedure (Sec. 5.5) and the nonlinear static procedure (Appendix to Chapter 5), if the factored foundation load capacity, ϕQ_{us} , is reached during seismic loading, the potential significance of associated transient and permanent foundation displacements shall be evaluated. Foundation displacements are acceptable if they do not impair the continuing function of Seismic Use Group III structures or the life safety of any structure.

For nonlinear analysis procedures, an additional evaluation of structural behavior shall be performed to check potential changes in structural ductility demands due to higher than anticipated foundation capacity. For this additional evaluation, values of Q_{us} shall be increased by the factor $1/\phi$.

A7.2.3 Foundation load-deformation modeling. Where permitted for the analysis procedures in Chapter 5 and the Appendix to Chapter 5, the load-deformation characteristics of the foundation-soil system (foundation stiffness), if included in the analysis, shall be modeled in accordance with the requirements of this section. For linear analysis methods, the linear load-deformation behavior of foundations shall be represented by an equivalent linear stiffness using soil properties that are compatible with the soil strain levels associated with the design earthquake motion. The strain-compatible shear modulus, G , and the associated strain-compatible shear wave velocity, v_s , needed for the evaluation of equivalent linear stiffness shall be determined using the criteria in Sec. 5.6.2.1.1 or based on a site-specific study. Parametric variations of not less than 50 percent increase and decrease in stiffness shall be incorporated in dynamic analyses unless smaller variations can be justified based on field measurements of dynamic soil properties or direct measurements of dynamic foundation stiffness.

For nonlinear analysis methods, the nonlinear load-deformation behavior of the foundation-soil system may be represented by a bilinear or multilinear curve having an initial equivalent linear stiffness and a limiting foundation capacity. The initial equivalent linear stiffness shall be determined as described above for linear analysis methods. The limiting foundation capacity shall be taken as the factored foundation load capacity, ϕQ_{us} . Parametric variations in analyses shall include: (1) a reduction in stiffness of 50 percent combined with a limiting foundation capacity, ϕQ_{us} , and (2) an increase in stiffness of 50 percent combined with a limiting foundation capacity equal to Q_{us} increased by a factor $1/\phi$.

This page is intentionally left blank

Chapter 8

STEEL STRUCTURE DESIGN REQUIREMENTS

8.1 GENERAL

8.1.1 Scope. The design, construction, and quality of steel components that resist seismic forces shall comply with the requirements of this chapter.

8.1.2 References. The following documents shall be used as specified in this chapter.

- AISC ASD *Allowable Stress Design and Plastic Design Specification for Structural Steel Buildings*, American Institute of Steel Construction, 1989 including supplement No. 1, (2001).
- AISC LRFD *Load and Resistance Factor Design Specification for Structural Steel Buildings*, American Institute of Steel Construction, 1999.
- AISC Seismic *Seismic Provisions for Structural Steel Buildings, Part I*, American Institute of Steel Construction, 2002.
- AISI—NASPEC *North American Specification for the Design of Cold-formed Steel Structural Members*, American Iron and Steel Institute, 2001.
- AISI—GP Standard for Cold-Formed Steel Framing—General Provisions, American Iron and Steel Institute, 2001
- AISI—PM Standard for Cold-Formed Steel Framing—Prescriptive Method for One and Two-Family Dwellings, American Iron and Steel Institute, 2001,
- ASCE 8 *Specification for the Design of Cold-formed Stainless Steel Structural Members*, American Society of Civil Engineers, 2002.
- SJI *Standard Specification, Load Tables and Weight Tables for Steel Joists and Joist Girders*, Steel Joist Institute, 2002.
- ASCE 19 *Structural Applications of Steel Cables for Buildings*, American Society of Civil Engineers, 1996.
- AWS D1.1 *Structural Welding Code Steel*, American Welding Society, 2000.
- ASTM A 653 *Specification for Steel Sheet, Zinc-Coated (Galvanized) or Zinc-Iron Alloy-Coated (Galvannealed) by the Hot-dip Process (A 653-97a)*, American Society for Testing and Materials, 1997.
- ASTM A 792 *Specification for Steel Sheet, 55% Aluminum-Zinc Alloy-Coated by the Hot-dip Process (A 792-97a)*, American Society for Testing and Materials, 1997.
- ASTM A 875 *Specification for Steel Sheet, Zinc-5% Aluminum Alloy-Coated by the Hot-dip Process (A 875-97a)*, American Society for Testing and Materials, 1997.

8.1.3 Definitions

Dead load: See Sec. 4.1.3.

Design strength: See Sec. 4.1.3.

Diaphragm: See Sec. 4.1.3.

Light-framed wall: See Sec. 12.1.3.

Light-framed shear wall: See Sec. 12.1.3.

Live load: See Sec. 4.1.3.

Nominal strength: See Sec. 4.1.3.

Registered design professional: See Sec. 2.1.3.

Required strength: See Sec. 4.1.3.

Seismic Design Category: See Sec. 1.1.4.

Seismic forces: See Sec. 1.1.4.

Shear panel: See Sec. 4.1.3.

Shear wall: See Sec. 4.1.3.

Story: See Sec. 4.1.3.

Structure: See Sec. 1.1.4.

Wall: See Sec. 4.1.3.

8.1.4 Notation

R See Sec. 4.1.4.

T_3 Net tension in steel cable due to dead load, prestress, and seismic load (Sec. 8.5).

T_4 Net tension in steel cable due to dead load, prestress, live load, and seismic load (Sec. 8.5).

ϕ See Sec. 5.1.3.

Ω_0 See Sec. 4.1.4.

8.2 GENERAL DESIGN REQUIREMENTS

8.2.1 Seismic Design Categories B and C. Steel structures assigned to Seismic Design Category B or C shall be of any construction permitted by the references in Sec. 8.1.2. An R factor as set forth in Table 4.3-1 for the appropriate steel system is permitted where the structure is designed and detailed in accordance with the requirements of AISC Seismic, as modified in Sec. 8.3, or in accordance with Sec. 8.4.1 and 8.4.2, for light-frame cold-formed steel wall systems. Systems not detailed in accordance with the above shall use the R factor in Table 4.3-1 designated for “Steel Systems Not Specifically Detailed for Seismic Resistance.”

8.2.2 Seismic Design Categories D, E, and F. Steel structures assigned to Seismic Design Category D, E, or F shall be designed and detailed in accordance with AISC Seismic as modified in Sec. 8.3. Light-frame cold-formed steel wall systems shall be designed and detailed in accordance with Sec. 8.4.2.

8.3 STRUCTURAL STEEL

8.3.1 Material properties for determination of required strength. Revise Table I-6-1 of AISC Seismic, as follows:

1. For the Application titled “Hot-rolled structural shapes and bars, All other grades,” change the R_y value from 1.1 to 1.2.

For the Application titled “All other products,” change the R_y value from 1.1 to 1.2.

8.4 COLD-FORMED STEEL

The design of cold-formed carbon or low-alloy steel members to resist seismic loads shall be in accordance with the requirements of AISI – NASPEC and AISI General and the design of cold-formed stainless steel structural members to resist seismic loads shall be in accordance with the requirements of ASCE 8, except as modified by this section.

8.4.1 Modifications to references

Modify Sec. 1.5.2 of ASCE 8 by substituting a load factor of 1.0 in place of 1.5 for nominal earthquake load.

8.4.2 Light-frame walls. Where required in Sec. 8.2.1 or 8.2.2, cold-formed steel stud walls designed in accordance with AISI – NASPEC, AISI-GP and ASCE 8 shall also comply with the requirements of this section.

8.4.2.1 Boundary members. All boundary members, chords, and collectors shall be designed to transmit the specified induced axial forces.

8.4.2.2 Connections. Connections for diagonal bracing members, top chord splices, boundary members, and collectors shall have a design strength equal to or greater than the nominal tensile strength of the members being connected or Ω_0 times the design seismic force. The pull-out resistance of screws shall not be used to resist seismic forces.

8.4.2.3 Braced bay members. In stud systems where the lateral forces are resisted by diagonal braces, the vertical and diagonal members in braced bays shall be anchored such that the bottom tracks are not required to resist uplift forces by bending of the track or track web. Both flanges of studs shall be braced to prevent lateral torsional buckling. In shear wall systems, the vertical boundary members shall be anchored so the bottom track is not required to resist uplift forces by bending of the track web.

8.4.2.4 Diagonal braces. Provision shall be made for pretensioning or other methods of installation of tension-only bracing to guard against loose diagonal straps.

8.4.2.5 Shear walls. Nominal shear strengths for shear walls framed with cold-formed steel studs are given in Table 8.4-1. Design shear strength shall be determined by multiplying the nominal shear strength by a ϕ factor of 0.55. The height to length ratio of wall systems listed in Table 8.4-1 shall not exceed 2:1. In structures over one story in height, the assemblies in Table 8.4-1 shall not be used to resist horizontal loads contributed by forces imposed by masonry or concrete construction.

Panel thicknesses shown in Table 8.4-1 shall be considered to be minimums. No panels less than 24 in. wide shall be used. Plywood or oriented strand board structural panels shall be of a type that is manufactured using exterior glue. Framing members, blocking or strapping shall be provided at the edges of all sheets. Fasteners along the edges in shear panels shall be placed not less than 3/8 in. (9.5 mm) in from panel edges. Perimeter members at openings shall be provided and shall be detailed to distribute the shearing stresses. Wood sheathing shall not be used to splice such members.

Studs shall be a minimum 1-5/8 in. (41 mm) by 3-1/2 in. (89 mm) with a 3/8-in. (9.5 mm) return lip. Track shall be a minimum 1-1/4 in. (32 mm) by 3-1/2 in. (89 mm). Both studs and track shall have a minimum uncoated base metal thickness of 0.033 in. (0.84 mm), shall not have an uncoated base metal thickness greater than 0.048 in. (1.22 mm), and shall satisfy the requirements for ASTM A 653 SS, Grade 33, ASTM A 792 SS, Grade 33, or ASTM A 875 SS, Grade 33. Panel end studs and their uplift anchorage shall have the design strength to resist the forces determined by the seismic loads determined using Eq. 4.2-3 and Eq. 4.2-4.

Framing screws shall be No. 8 x 5/8 in. (16 mm) wafer head self-drilling. Plywood and OSB screws shall be a minimum No. 8 x 1 in. (25 mm) bugle head. Where horizontal straps are used to provide blocking they shall be a minimum 1-1/2 in. (38 mm) wide and of the same material as the stud and track. Such straps shall have a thickness at least as great as the thicker of that of the stud and the track.

**Table 8.4-1 Nominal Shear Strength (plf)^a
for Shear Walls Framed with Cold-formed Steel Studs**

Assembly Description	Fastener Spacing at Panel Edges (in.) ^b				Framing Spacing
	6	4	3	2	
15/32 rated Structural I sheathing (4-ply) plywood one side ^c	780	990	1465	1625	24 in. o.c.
7/16 in. oriented strand board one side ^c	700	915	1275	1700	24 in. o.c.
^a For metric: 1 in. = 25.4 mm, 1 plf = 14.6 N/m.					
^b Screws in the field of the panel shall be installed 12 in. o.c. unless otherwise shown.					
^c Both flanges of the studs shall be braced in accordance with Sec. 8.4.2.3.					

8.4.3 Prescriptive framing

One and two family dwellings are permitted to be designed and constructed in accordance to the provisions in the AISI—PM subject to the limitations therein.

8.4.4 Steel deck diaphragms. Steel deck diaphragms shall be made from materials which satisfy the requirements of AISI and ASCE 8. Nominal strengths shall be determined in accordance with approved analytical procedures or with test procedures prepared by a registered design professional experienced in testing of cold-formed steel assemblies and approved by the authority having jurisdiction. Design strengths shall be determined by multiplying the nominal strength by a resistance factor, ϕ , equal to 0.60 (for mechanically connected diaphragms) and equal to 0.50 (for welded diaphragms). The steel deck installation for the structure, including fasteners, shall comply with the test assembly arrangement. Quality standards established for the nominal strength test shall be the minimum standards required for the steel deck installation, including fasteners.

8.5 STEEL CABLES

The design strength of steel cables shall be determined in accordance with ASCE 19 except as modified by these Provisions. A load factor of 1.1 shall be applied to the prestress force included in T_3 and T_4 as defined in Sec. 3.1.2 of ASCE 19. In Sec. 3.2.1 of ASCE 19, item (c) shall be replaced with “1.5 T_3 ” and item (d) shall be replaced with “1.5 T_4 ”.

8.6 RECOMMENDED PROVISIONS FOR BUCKLING-RESTRAINED BRACED FRAMES

The following shall be used in conjunction with AISC Seismic.

8.6.1 Symbols

A_{sc}	Area of the yielding segment of steel core, in. ² (BRBF)
P_{ysc}	Axial yield strength of steel core, kips (BRBF)
Q_b	Maximum unbalanced load effect applied to beam by braces, kips. (BRBF)
β	Compression strength adjustment factor (BRBF)
w	Tension strength adjustment factor. (BRBF)

8.6.2 Glossary

Buckling Restrained Braced Frame (BRBF): A diagonally braced frame meeting the requirements of Sec. 8.6.3 in which all members of the bracing system are subjected primarily to axial forces and in which the limit state of compression buckling of braces is precluded at forces and deformations corresponding to 1.5 times the Design Story Drift.

Buckling-Restraining System: A system of restraints that limits buckling of the steel core in BRBF. This system includes the casing on the steel core and structural elements adjoining its connections. The buckling-restraining system is intended to permit the transverse expansion and longitudinal contraction of the steel core for deformations corresponding to 1.5 times the Design Story Drift.

Casing: An element that resists forces transverse to the axis of the brace thereby restraining buckling of the core. The casing requires a means of delivering this force to the remainder of the buckling-restraining system. The casing resists little or no force in the axis of the brace.

Steel Core: The axial-force-resisting element of braces in BRBF. The steel core contains a yielding segment and connections to transfer its axial force to adjoining elements; it may also contain projections beyond the casing and transition segments between the projections and yielding segment.

8.6.3 BUCKLING-RESTRAINED BRACED FRAMES (BRBF)

8.6.3.1 Scope. Buckling-restrained braced frames (BRBF) are expected to withstand significant inelastic deformations when subjected to the forces resulting from the motions of the Design Earthquake. BRBF shall meet the requirements in this section.

8.6.3.2 Bracing Members

8.6.3.2.1 Composition: Bracing members shall be composed of a structural steel core and a system that restrains the steel core from buckling.

8.6.3.2.1.1 Steel core. The steel core shall be designed to resist the entire axial force in the brace.

8.6.3.2.1.1.1 Required strength of steel core. The required axial strength of the brace shall not exceed the design strength of the steel core, ϕP_{ysc} ,

where $\phi = 0.9$

$$P_{ysc} = F_y A_{sc}$$

F_y = specified minimum yield strength of steel core

A_{sc} = net area of steel core

8.6.3.2.1.1.2 Detailing

8.6.3.2.1.1.2.1. Plates used in the steel core that are 2 in. thick or greater shall satisfy the minimum toughness requirements of Sec. 6.3 (AISC Seismic).

8.6.3.2.1.1.2.2. Splices in the steel core are not permitted.

8.6.3.2.1.2 Buckling-restraining system. The buckling-restraining system shall consist of the casing for the steel core. In stability calculations, beams, columns, and gussets connecting the core shall be considered parts of this system.

8.6.3.2.1.2.1 Restraint. The buckling-restraining system shall limit local and overall buckling of the

steel core for deformations corresponding to 1.5 times the Design Story Drift. The buckling-restraining system shall not be permitted to buckle within deformations corresponding to 1.5 times the Design Story Drift.

8.6.3.2.2 Testing. The design of braces shall be based upon results from qualifying cyclic tests in accordance with the procedures and acceptance criteria of Sec. 8.6.3.7. Qualifying test results shall consist of at least two successful cyclic tests: one is required to be a test of a brace subassembly that includes brace connection rotational demands complying with Sec. 8.6.3.7.4 and the other shall be either a uniaxial or a subassembly test complying with Sec. 8.6.3.7.5. Both test types are permitted to be based upon one of the following:

8.6.3.2.2.1 Types of qualifying tests

8.6.3.2.2.1.1. Tests reported in research or documented tests performed for other projects that are demonstrated to reasonably match project conditions.

8.6.3.2.2.1.2. Tests that are conducted specifically for the project and are representative of project member sizes, material strengths, brace-end connection configurations, and matching assembly and quality control processes.

8.6.3.2.2.2 Applicability. Interpolation or extrapolation of test results for different member sizes shall be justified by rational analysis that demonstrates stress distributions and magnitudes of internal strains that are consistent with or less severe than the tested assemblies and that considers the adverse effects of larger material and variations in material properties. Extrapolation of test results shall be based upon similar combinations of steel core and buckling-restraining system sizes. Tests shall be permitted to qualify a design when the provisions of Sec. 8.6.3.7 are met.

8.6.3.2.2.3 Compression strength adjustment factor (β). Shall be calculated as the ratio of the maximum compression force to the maximum tension force of the Test Specimen measured from the qualification tests specified in Sec. 8.6.3.7.6.3 for the range of deformations corresponding to 1.5 times the Design Story Drift. The larger value of β from the two required brace qualification tests shall be used. In no case shall β be taken as less than 1.0.

8.6.3.2.2.4 Tension strength adjustment factor (ω). Shall be calculated as the ratio of the maximum tension force measured from the qualification tests specified in Sec. 8.6.3.7.6.3 (for the range of deformations corresponding to 1.5 times the Design Story Drift) to the nominal yield strength of the Test Specimen. The larger value of ω from the two required qualification tests shall be used. Where the tested steel core material does not match that of the prototype, ω shall be based on coupon testing of the prototype material.

8.6.3.2.3 Quality assurance. The buckling restrained brace manufacturer shall establish a Quality Assurance Plan that complies with Sec. 16 (AISC Seismic) and the Code of Standard Practice for Steel Buildings and Bridges. The brace manufacturer shall submit the proposed Quality Assurance Plan to the Engineer of Record for review and approval. The fabrication of buckling restrained braces shall meet the requirements of the approved Quality Assurance Plan. Only buckling restrained braces meeting all applicable requirements of the approved Quality Assurance Plan will be used in construction.

8.6.3.3 Bracing connections

8.6.3.3.1 Required strength. The required strength of bracing connections in tension and compression (including beam-to-column connections if part of the bracing system) shall be $\beta\omega R_y P_{ysec}$.

Exception: The factor R_y need not be applied if P_{ysec} is established using yield stress determined from a coupon test or mill certificate.

8.6.3.3.2 Gusset Plate. The design of connections shall include considerations of local and overall buckling.

8.6.3.4 Special requirements related to bracing configuration

8.6.3.4.1 V-type and inverted-V-type bracing. V-type and inverted-V-type braced frames shall meet the following requirements:

8.6.3.4.1.1. A beam that is intersected by braces shall be continuous between columns and shall be designed to resist the effects of load combinations stipulated by the Applicable Building Code, assuming the bracing is not present. For load combinations that include seismic, a load Q_b shall be substituted for the term E . Q_b is the maximum load effect applied to the beam by the braces. This vertical and horizontal load effect shall be calculated using $\beta\omega P_{y_{sc}}$ for the brace in compression and $\omega P_{y_{sc}}$ for the brace in tension. The required flexural strength for the load combinations that include seismic shall not exceed M_y as defined in AISC LRFD Chapter F.

8.6.3.4.1.2 Beam stiffness. Beam deflections under the load combination $D+Q_b$ (as defined in 16.4a.1.) shall not exceed $L/240$, where L is the beam span between column lines.

8.6.3.4.1.3. Deformation. For the purposes of brace design and testing, the calculated maximum deformation of braces shall be increased by including the effect of the vertical deflection of the beam under the loading defined in Sec.8.6.3.4.1.1

8.6.3.4.1.4. Lateral support of the beam shall be provided when required for stability. The analysis shall include consideration of Q_b and the axial force in the beam.

8.6.3.4.2 K-Type Bracing. K-type braced frames are not permitted for BRBF.

8.6.3.5 Columns. Columns in BRBF shall meet the following requirements:

8.6.3.5.1 Width-thickness Ratios. Compression elements of columns shall satisfy the width-thickness limitations in Table I-8-1(AISC Seismic).

8.6.3.5.2 Splices. In addition to meeting the requirements in Sec. 8.3 (AISC Seismic), column splices in BRBF shall be designed to develop at least the nominal shear strength of the smaller connected member and 50 percent of the flexural strength of the smaller connected member. Splices shall be located in the middle one-third of the column clear height.

8.6.3.5.3 Required Strength. In addition to the requirements in Sec. 8.3 (AISC Seismic), the required strength of columns in BRBF shall be determined from load combinations as stipulated in the Applicable Building Code, except that the seismic axial forces shall be determined from the maximum brace forces that can be introduced at each level. The maximum brace tension force shall be taken as $\omega P_{y_{sc}}$. The maximum brace compression force shall be taken as $\beta\omega P_{y_{sc}}$. The required column strength need not exceed the maximum force that can be delivered by the system.

8.6.3.6 Beams. Beams in BRBF shall meet the following requirements:

8.6.3.6.1 Width-thickness ratios. Compression elements of beams shall satisfy the width-thickness limitations in Table I-8-1 (AISC Seismic).

8.6.3.6.2 Required Strength. The required strength of beams shall include the effects of dead and live loads in conjunction with axial forces corresponding to the maximum brace forces. The maximum brace tension force shall be taken as $\omega P_{y_{sc}}$. The maximum brace compression force shall be taken as $\beta\omega P_{y_{sc}}$.

8.6.3.7 Qualifying Cyclic Tests Of Buckling-Restrained Braces

8.6.3.7.1 Scope and purpose. This Appendix includes requirements for qualifying cyclic tests of individual buckling-restrained braces and buckling-restrained brace subassemblages, when required in these provisions. The purpose of the testing of individual braces is to provide evidence that a buckling-

restrained brace satisfies the requirements for strength and inelastic deformation in these provisions; it also permits the determination of maximum brace forces for design of adjoining elements. The purpose of testing of the brace subassembly is to provide evidence that the brace-design can satisfactorily accommodate the deformation and rotational demands associated with the design. Further, the subassembly test is intended to demonstrate that the hysteretic behavior of the brace in the subassembly is consistent with that of the individual brace elements tested uniaxially.

Alternative testing requirements are permitted when approved by the Engineer of Record and the regulatory agency.

This Appendix provides only minimum recommendations for simplified test conditions. If conditions in the actual building so warrant, additional testing shall be performed to demonstrate satisfactory and reliable performance of buckling-restrained braces during actual earthquake ground motions.

8.6.3.7.2 Symbols. The numbers in parenthesis after the definition of a symbol refers to the Section number in which the symbol is first used.

D_b Deformation quantity used to control loading of test specimen (total brace end rotation for the subassembly test specimen; total brace axial deformation for the brace test specimen) (Sec. 8.6.3.7.6).

D_{bm} Value of deformation quantity, D_b , corresponding to the design story drift (Sec. 8.6.3.7.6).

D_{by} Value of deformation quantity, D_b , at first significant yield of test specimen (Sec. 8.6.3.7.6).

8.6.3.7.3 Definitions

Brace Test Specimen: A single buckling-restrained brace element used for laboratory testing intended to model the brace in the Prototype.

Design Methodology: A set of step-by-step procedures, based on calculation or experiment, used to determine sizes, lengths, and details in the design of buckling-restrained braces and their connections.

Inelastic Deformation: The permanent or plastic portion of the axial displacement in a buckling-restrained brace, divided by the length of the yielding portion of the brace, expressed in percent.

Prototype: The brace, connections, members, steel properties, and other design, detailing, and construction features to be used in the actual building frame.

Subassembly Test Specimen: The combination of the brace, the connections and testing apparatus that replicate as closely as practical the axial and flexural deformations of the brace in the Prototype.

Test Specimen: Brace Test Specimen or Subassembly Test Specimen.

8.6.3.7.4 Subassembly test specimen. The subassembly test specimen shall satisfy the following requirements:

1. The mechanism for accommodating inelastic curvature in the subassembly test specimen brace shall be the same as that of the prototype. The rotational deformation demands on the subassembly Test Specimen brace shall be equal to or greater than those of the Prototype.
2. The axial yield strength of the steel core of the brace in the subassembly test specimen shall not be less than of that of the prototype as determined from mill certificate or coupon test.
3. The cross-sectional shape and orientation of the steel core projection of the subassembly test specimen brace shall be the same as that of the brace in the Prototype.
4. The same documented design methodology shall be used for design of the subassembly and brace and of the Prototype and for comparison of the rotational deformation demands on the subassembly brace and on the prototype in the construction.

5. The calculated margins of safety for the prototype connection design, steel core projection stability, overall buckling and other relevant subassembly test specimen brace construction details, excluding the gusset plate, for the Prototype, shall equal or exceed those of the subassembly test specimen construction.
6. Lateral bracing of the subassembly test specimen shall replicate the lateral bracing in the prototype.
7. The brace test specimen and the prototype shall be manufactured in accordance with the same quality control and assurance processes and procedures.

Extrapolation beyond the limitations stated in this section shall be permitted subject to qualified peer review and building official approval.

8.6.3.7.5 Brace test specimen. The brace test specimen shall replicate as closely as is practical the pertinent design, detailing, construction features, and material properties of the prototype.

8.6.3.7.5.1 Design of brace test specimen. The same documented design methodology shall be used for the brace test specimen and the prototype. The design calculations shall demonstrate, at a minimum, the following requirements:

1. The calculated margin of safety for stability against overall buckling for the prototype shall equal or exceed that of the brace test specimen.
2. The calculated margins of safety for the brace test specimen and the prototype shall account for differences in material properties, including yield and ultimate stress, ultimate elongation, and toughness.

8.6.3.7.5.2 Manufacture of brace test specimen. The brace test specimen and the prototype shall be manufactured in accordance with the same quality control and assurance processes and procedures.

8.6.3.7.5.3 Similarity of brace test specimen and prototype. The brace test specimen shall meet the following requirements:

1. The cross-sectional shape and orientation of the steel core shall be the same as that of the prototype.
2. The axial yield strength of the steel core of the brace test specimen shall not vary by more than 50 percent from that of the prototype as determined from mill certificates or coupon tests.
3. The material for, and method of, separation between the steel core and the buckling restraining mechanism in the brace test specimen shall be the same as that in the prototype.

Extrapolation beyond the limitations stated in this section shall be permitted subject to qualified peer review and building official approval.

8.6.3.7.5.4 Connection details. The connection details used in the brace test specimen shall represent the Prototype connection details as closely as practical.

8.6.3.7.5.5 Materials

1. Steel core: The following requirements shall be satisfied for the steel core of the brace test specimen:
 - a. The nominal yield stress of the prototype steel core shall be the same as that of the brace test specimen.
 - b. The yield strength of the material of the steel core in the prototype shall not exceed 110 percent of that of the brace test specimen as determined from mill certificates or coupon tests.
 - c. The specified minimum ultimate stress and strain of the prototype steel core shall meet

or exceed those of the brace test specimen.

2. Buckling-restraining mechanism: Materials used in the buckling-restraining mechanism of the brace test specimen shall be the same as those used in the prototype.

8.6.3.7.5.6 Welds. The welds on the test specimen shall replicate those on the prototype as close as practical. The following parameters shall be the same or more stringent in the prototype as in the test specimen: welding procedure specification, minimum filler metal toughness, welding positions, and inspection and nondestructive testing requirements and acceptance criteria.

8.6.3.7.5.7 Bolts. The bolted portions of the brace test specimen shall replicate the bolted portions of the prototype as closely as possible.

8.6.3.7.6 Loading history

8.6.3.7.6.1 General requirements. The test specimen shall be subjected to cyclic loads according to the requirements prescribed on Sec. 8.3.7.6.2 and 8.3.7.6.3. Additional increments of loading beyond those described in Sec. 8.3.7.6.3 are permitted. Each cycle shall include a full tension and full compression excursion to the prescribed deformation.

8.6.3.7.6.2 Test Control. The test shall be conducted by controlling the level of axial or rotational deformation, (D_b) imposed on the test specimen. As an alternate, the maximum rotational deformation may be applied and maintained as the protocol is followed for axial deformation.

8.6.3.7.6.3 Loading sequence. Loads shall be applied to the test specimen to produce the following deformations, where the deformation is the steel core axial deformation for the Test Specimen and the rotational deformation demand for the subassembly test specimen brace:

1. 6 cycles of loading at the deformation corresponding to $D_b = D_{by}$
2. 4 cycles of loading at the deformation corresponding to $D_b = 0.50 D_{bm}$
3. 4 cycles of loading at the deformation corresponding to $D_b = 1 D_{bm}$
4. 2 cycles of loading at the deformation corresponding to $D_b = 1.5 D_{bm}$
5. Additional complete cycles of loading at the deformation corresponding to $D_b = 1 D_{bm}$ as required for the Brace Test Specimen to achieve a cumulative inelastic axial deformation of at least 140 times the yield deformation (not required for the subassembly test specimen).

The design story drift shall not be taken as less than 0.01 times the story height for the purposes of calculating D_{bm} . D_{bm} need not be taken as greater than $5D_{by}$.

Other loading sequences are permitted to be used to qualify the test specimen when they are demonstrated to be of equal or greater severity in terms of maximum and cumulative inelastic deformation.

8.6.3.7.7 Instrumentation. Sufficient instrumentation shall be provided on the test specimen to permit measurement or calculation of the quantities listed in Sec. 8.6.3.7.9.

8.6.3.7.8 Materials testing requirements

8.6.3.7.8.1 Tension testing requirements. Tension testing shall be conducted on samples of steel taken from the same material as that used to manufacture the steel core. Tension-test results from certified mill test reports shall be reported but are not permitted to be used in place of specimen testing for the purposes of this Section. Tension-test results shall be based upon testing that is conducted in accordance with Sec. 8.6.3.7.8.2.

8.6.3.7.8.2 Methods of tension testing. Tension testing shall be conducted in accordance with ASTM A6, ASTM A370, and ASTM E8, with the following exceptions:

1. The yield stress, F_y , that is reported from the test shall be based upon the yield strength definition in ASTM A370, using the offset method of 0.002 strain.
2. The loading rate for the tension test shall replicate, as closely as is practical, the loading rate used for the Test Specimen.

8.6.3.7.9 Test reporting requirements

For each Test Specimen, a written test report meeting the requirements of this section shall be prepared. The report shall thoroughly document all key features and results of the test. The report shall include the following information:

1. A drawing or clear description of the test specimen, including key dimensions, boundary conditions at loading and reaction points, and location of lateral bracing if any.
2. A drawing of the connection details showing member sizes, grades of steel, the sizes of all connection elements, welding details including filler metal, the size and location of bolt holes, the size and grade of bolts, and all other pertinent details of the connections.
3. A listing of all other essential variables as listed in Sec. 8.6.3.7.4 or 8.6.3.7.5 as appropriate.
4. A listing or plot showing the applied load or displacement history.
5. A plot of the applied load versus the deformation (D_b). The method used to determine the deformations shall be clearly shown. The locations on the Test Specimen where the loads and deformations were measured shall be clearly identified.
6. A chronological listing of significant test observations, including observations of yielding, slip, instability, transverse displacement along the Test Specimen and fracture of any portion of the Test Specimen and connections, as applicable.
7. The results of the material tests specified in Sec. 8.6.3.7.8.
8. The manufacturing quality control and quality-assurance plans used for the fabrication of the test specimen. These shall be included with the welding procedure specifications and welding inspection reports.

Additional drawings, data, and discussion of the test specimen or test results are permitted to be included in the report.

8.6.3.7.10 Acceptance criteria. At least one subassembly test shall be performed to satisfy the requirements of Sec. 8.6.3.7.4. At least one brace test shall be performed to satisfy the requirements of Sec. 8.6.3.7.5. Within the required protocol range all tests shall satisfy the following requirements:

1. The plot showing the applied load vs. displacement history shall exhibit stable, repeatable behavior with positive incremental stiffness.
2. There shall be no fracture, brace instability or brace end connection failure.
3. For brace tests, each cycle to a deformation greater than D_{by} , the maximum tension and compression forces shall not be less than $1.0 P_{ysec}$.
4. For brace tests, each cycle to a deformation greater than D_{by} , the ratio of the maximum compression force to the maximum tension force shall not exceed 1.3.

Other acceptance criteria may be adopted for the brace test specimen or subassembly test specimen subject to qualified peer review and building official approval.

8.7 RECOMMENDED PROVISIONS FOR SPECIAL STEEL PLATE WALLS

The following shall be used in conjunction with AISC Seismic.

8.7.1 Symbols

t_w	Thickness of the web
L_{cf}	Clear distance between vertical boundary elements (VBEs) flanges.
h	Distance between horizontal boundary elements (HBE) centerlines.
A_b	The average of the cross-sectional area of a HBE bounding the panel.
A_c	The average of the cross-sectional area of a VBE bounding the panel.
I_c	Moment of inertia of a VBE.
L	Distance between VBE centerlines.
α	Angle of web yielding.

8.7.2 Glossary

Webs: The slender unstiffened steel plates connected to surrounding horizontal and vertical boundary elements to resist lateral loads.

Horizontal boundary elements are structural shapes oriented horizontally and framing the Webs of special steel plate walls.

Vertical boundary elements are structural shapes oriented vertically and framing the Webs of special steel plate walls.

Panel: Each Web and its surrounding elements constitute a panel.

8.7.3 Scope. Special steel plate walls (SSPWs) are expected to withstand significant inelastic deformations in the Webs when subjected to the forces resulting from the motions of the design earthquake. The HBEs and VBEs adjacent to the webs shall be designed to remain essentially elastic under the maximum forces that can be generated by the fully yielded webs, except that plastic hinging at the ends of HBEs is permitted. SSPWs shall meet the requirements in this section.

8.7.4 Webs**8.7.4.1**

The nominal strength of a panel is given by:

$$V_n = 0.42 F_y t_w L_{cf} \sin 2\alpha$$

where :

t_w is the thickness of the web,

L_{cf} is the clear distance between VBE flanges, and

α is given by

$$\tan^4 \alpha = \frac{1 + \frac{t_w L}{2A_c}}{1 + t_w h \left(\frac{1}{A_b} + \frac{h^3}{360I_c L} \right)}$$

where:

h = the distance between HBE centerlines,

A_b = cross-sectional area of a HBE,

A_c = cross-sectional area of a VBE,

I_c = moment of inertia of a VBE, and

L = the distance between VBE centerlines.

The panel design strength shall be ϕV_n , where ϕ is 0.9.

8.7.4.2 Panel aspect ratio. The ratio of panel length to height, L/h , shall be greater than 0.8, but shall not exceed 2.5.

8.7.4.3 Openings in webs. Openings in webs shall be bounded on all sides by HBE's and VBE's extending the full width and height of the panel respectively, unless otherwise justified by testing and analysis.

8.7.4.4 Maximum slenderness ratio for plates. The maximum width-thickness ratio of plate elements shall be $25\sqrt{E/F_y}$. The width shall be taken as the shortest distance between boundary elements.

8.7.5 Connections of webs to boundary elements. The required strength of Web connections to the surrounding HBE's and VBE's shall equal the expected yield strength, in tension, of the Web calculated at an angle α .

8.7.6 Horizontal and vertical boundary elements (HBEs and VBEs)

8.7.6.1 Strength of boundary elements. In addition to the requirements of Sect. 8.3 of AISC Seismic, the required strength of VBE's shall be based upon the forces corresponding to the expected yield strength (in tension) of the Web calculated at an angle α .

The required strength of HBE's shall be the greater of the forces corresponding to the expected yield strength (in tension) of the Web calculated at an angle α or that determined from the load combinations in ASCE 7 assuming the web provides no support for gravity loads.

8.7.6.2 HBE to VBE connections. HBE to VBE connections shall be made with HBE flanges welded to VBE. HBE webs may be bolted or welded to VBE. Partial joint penetration welds are not permitted at the HBE flange weld. The connection shall have a required strength M_u of at least $1.1R_yM_p$ of the HBE. The required shear strength V_u of a HBE-to-VBE connection shall be determined from the load combinations as stipulated in the ASCE 7 except that the required shear strength shall not be less than the shear corresponding to moments at each end equal to $1.1R_yM_p$ together with the shear resulting from the expected tensile strength of the Webs yielding at an angle α .

8.7.6.3 Boundary elements compactness. The width-thickness ratios of HBEs and VBEs shall comply with the requirements in Table I-8-1(AISC Seismic)

Modify Footnotes b and c to Table I-8-1(AISC Seismic) by including SSPW to both footnotes.

8.7.6.4 Lateral Bracing. HBE's shall be laterally braced at all intersections with VBE's and at a spacing not to exceed $0.086 r_y E_s / F_y$. Both flanges of HBE's shall be braced either directly or indirectly. The required strength of lateral bracing shall be at least 2 percent of the HBE's flange nominal strength, $F_y b_f t_f$. The required stiffness of all lateral bracing shall be determined in accordance with Equations C3-8 or C3-10 as applicable in the AISC LRFD. In these equations, M_u shall be computed as $R_y Z F_y$.

8.7.6.5 VBE splices. VBE splices shall comply with the requirements of Sec. 8.4 (AISC Seismic).

8.7.6.6 Panel zones. The VBE panel zone next to the top and base horizontal boundary elements of the SSPW shall comply with the requirements in Sec. 9.3 (AISC Seismic).

8.7.6.7 Stiffness of vertical boundary elements. The VBE shall have moments of inertia about an axis perpendicular to the direction of the web plate, I_c , not less than $0.00307 t_w h^4 / L$.

This page is intentionally left blank.

Chapter 9

CONCRETE STRUCTURE DESIGN REQUIREMENTS

9.1 GENERAL

9.1.1 Scope. The quality and testing of concrete and steel (reinforcing and anchoring) materials and the design and construction of concrete components that resist seismic forces shall comply with the requirements of ACI 318 except as modified in this chapter.

9.1.2 References. The following documents shall be used as specified in this chapter.

ACI 318	<i>Building Code Requirements for Structural Concrete</i> , American Concrete Institute, 2002.
ACI T1.1	<i>Acceptance Criteria for Moment Frames Based on Structural Testing</i> , American Concrete Institute, 2001.
ATC-24	<i>Guidelines for Seismic Testing of Components of Steel Structures</i> , Applied Technology Council, 1992.

9.1.3 General definitions

Base: See Sec. 4.1.3. Base is defined as “base of structure” in Sec. 21.1 of ACI 318.

Basement: See Sec. 7.1.3.

Boundary elements: See Sec. 2.1.3 and Sec. 21.1 of ACI 318.

Confined region: The portion of a reinforced concrete component in which the concrete is confined by closely spaced special transverse reinforcement restraining the concrete in directions perpendicular to the applied stress.

Coupling beam: A beam that is used to connect adjacent concrete wall elements to make them act together as a unit to resist lateral loads.

Design strength: See Sec. 4.1.3.

Diaphragm: See Sec. 4.1.3. Diaphragm is defined as “structural diaphragm” in Sec. 21.1 of ACI 318.

Intermediate moment frame: See Sec. 4.1.3 and Sec. 21.1 of ACI 318.

Joint: See Sec. 21.1 of ACI 318.

Moment frame: See Sec. 4.1.3 and Sec. 21.1 of ACI 318.

Nominal strength: See Sec. 4.1.3.

Ordinary moment frame: See Sec. 4.1.3 and Sec. 21.1 of ACI 318.

Plain concrete: See Sec. 2.1 of ACI 318.

Reinforced concrete: See Sec. 2.1 of ACI 318.

Required strength: See Sec. 4.1.3.

Seismic Design Category: See Sec. 1.1.4.

Seismic-force-resisting system: See Sec. 1.1.4. Seismic-force-resisting system is defined as “lateral-force-resisting system” in Sec. 21.1 of ACI 318.

Seismic forces: See Sec. 1.1.4. Seismic forces are defined as “specified lateral forces” in Sec. 21.1 of ACI 318.

Shear wall: See Sec. 4.1.3. Shear walls are defined as “structural walls” in Sec. 21.1 of ACI 318.

Special moment frame: See Sec. 4.1.3 and Sec. 21.1 of ACI 318.

Special transverse reinforcement: Reinforcement composed of spirals, closed stirrups, or hoops and supplementary cross-ties provided to restrain the concrete and qualify the portion of the component, where used, as a confined region.

Story: See Sec. 4.1.3.

Structure: See Sec. 1.1.4.

Wall: See Sec. 4.1.3.

9.2 GENERAL DESIGN REQUIREMENTS

9.2.1 Classification of shear walls. Structural concrete shear walls that resist seismic forces shall be classified in accordance with this section.

9.2.1.1 Ordinary plain concrete shear walls. Ordinary plain concrete shear walls shall satisfy the requirements of Sec. 21.1 of ACI 318 for ordinary structural plain concrete walls.

9.2.1.2 Detailed plain concrete shear walls. Detailed plain concrete shear walls above the base shall satisfy the requirements of Sec. 21.1 of ACI 318 for ordinary structural plain concrete walls and contain reinforcement as follows:

Vertical reinforcement of at least 0.20 in.^2 (129 mm^2) in cross-sectional area shall be provided continuously from support to support at each corner, at each side of each opening, and at the ends of walls. The reinforcement required by Sec. 22.6.6.5 of ACI 318 shall be provided.

Horizontal reinforcement of at least 0.20 in.^2 (129 mm^2) in cross-sectional area shall be provided:

1. Continuously at structurally connected roof and floor levels and at the top of walls,
2. At the bottom of load-bearing walls or in the top of foundations where doweled to the wall, and
3. At a maximum spacing of 120 in. (3050 mm).

Reinforcement at the top and bottom of openings, where used in determining the maximum spacing specified in Item 3 above, shall be continuous in the wall.

Basement, foundation, or other walls below the base shall be reinforced as required by Sec. 22.6.6.5 of ACI 318.

9.2.1.3 Ordinary precast shear walls. Ordinary precast shear walls shall satisfy the requirements of Sec. 21.1 of ACI 318 for ordinary precast structural walls. See Sec. 9.2.2.1.1.

9.2.1.4 Ordinary reinforced concrete shear walls. Ordinary reinforced concrete shear walls shall satisfy the requirements of Sec. 21.1 of ACI 318 for ordinary reinforced concrete structural walls. See Sec. 9.2.2.1.1.

9.2.1.5 Intermediate precast shear walls. Intermediate precast shear walls shall satisfy the requirements of both Sec. 21.1 of ACI 318 and Sec. 9.2.2.5 for intermediate precast structural walls.

9.2.1.6 Special reinforced concrete shear walls. Special reinforced concrete shear walls shall satisfy the requirements of Sec. 21.1 of ACI 318 for special reinforced concrete structural walls or for special precast structural walls.

9.2.2 Modifications to ACI 318

9.2.2.1 General

9.2.2.1.1 Additional or modified definitions. Add or modify the following definitions in Sec. 21.1 of ACI 318:

Design displacement: Design story drift as specified in Sec. 5.2.6.1 of the 2003 *NEHRP Recommended Provisions*.

Design load combinations: Combinations of factored loads and forces specified in Sec. 9.2 or C.2 where seismic load E is specified in Sec. 4.2.2 of the 2003 *NEHRP Recommended Provisions*.

Ordinary precast structural wall: A wall incorporating precast concrete elements and complying with the requirements of Chapters 1 through 18 with the requirements of Chapter 16 superseding those of Chapter 14.

Ordinary reinforced concrete structural wall: A cast-in-place wall complying with the requirements of Chapters 1 through 18.

Wall pier: A wall segment with a horizontal length-to-thickness ratio of at least 2.5, but not exceeding 6, whose clear height is at least two times its horizontal length.

9.2.2.1.2 Additional notation. Add or modify the following notation in Sec. 21.0 of ACI 318:

Δ_m = $C_d \Delta_s$. Also equal to δ_u of ACI 318.

Δ_s = design level response displacement, which is the total drift or total story drift that occurs when the structure is subjected to the design seismic forces.

9.2.2.1.3 Scope: Delete Sec. 21.2.1.2, 21.2.1.3, and 21.2.1.4 of ACI 318 and replace with the following:

“21.2.1.2 For structures assigned to Seismic Design Category A or B, provisions of Chapters 1 through 18 and 22 shall apply except as modified by the requirements of Chapter 9 of the 2003 *NEHRP Recommended Provisions*. Where the design seismic loads are computed using provisions for intermediate or special concrete systems, the requirements of Chapter 21 for intermediate or special systems, as applicable, shall be satisfied.

“21.2.1.3 For structures assigned to Seismic Design Category C, intermediate or special moment frames, ordinary or special reinforced concrete structural walls, or intermediate or special precast structural walls shall be used to resist seismic forces induced by earthquake motions. Where the design seismic loads are computed using the provisions for intermediate or special concrete systems, the requirements of Chapter 21 for special systems, as applicable, shall be satisfied.

“21.2.1.4 For structures assigned to Seismic Design Category D, E or F, special moment frames, special structural walls, diaphragms, trusses and foundations complying with Sec. 21.2 through 21.10, or intermediate precast structural walls complying with 21.13, shall be used to resist earthquake motions. Frame members not proportioned to resist earthquake forces shall comply with Sec. 21.11.”

9.2.2.1.4. Delete Sec. 21.2 of ACI 318 and replace with following:

“21.2.5 Reinforcement in members resisting earthquake-induced forces.

“21.2.5.1 Deformed reinforcement resisting earthquake-induced flexural and axial forces in the frame members and in structural wall boundary elements shall comply with ASTM A 706. ASTM A 615 Grades 40 and 60 reinforcement shall be permitted in these members if:

“(a) The actual yield strength based on mill tests does not exceed the specified yield strength by more than 18,000 psi (retests shall not exceed this value by more than an additional 3000 psi); and

“(b) The ratio of the actual ultimate tensile strength to the actual tensile yield strength is not less than 1.25.

“**21.2.5.2** Prestressing steel resisting earthquake-induced flexural and axial loads in frame members shall comply with ASTM A 421 or ASTM A 722. The average prestress, f_{pc} , calculated for an area equal to the member’s shortest cross-sectional dimension multiplied by the perpendicular dimension shall not exceed the lesser of 700 psi or $f'_c/6$ at plastic hinge regions.

“ **21.2.9 –Anchorages for post-tensioning tendons.**

“**21.2.9** Anchorages for unbonded post-tensioning tendons resisting earthquake induced forces in structures in regions of moderate or high seismic risk, or assigned to intermediate or high seismic performance or design categories shall withstand, without failure, 50 cycles of loading between 40 and 85 percent of the specified tensile strength of the prestressing steel.”

9.2.2.2 Special moment frames. Add the following new Sec. 21.3.2.5 to ACI 318:

“**21.3.2.5** – Unless the special moment frame is qualified for use through structural testing as required by 21.6.3, for flexural members, prestressing steel shall not provide more than one quarter of the strength for either positive or negative moment at the critical section in a plastic hinge location and shall be anchored at or beyond the exterior face of a joint.”

9.2.2.3 Special reinforced concrete shear walls

9.2.2.3.1. In Sec. 21.7.3 of ACI 318, change “factored load combinations” to “design load combinations.”

9.2.2.3.2. Add a new Sec. 21.7.10 to ACI 318 which reads as follows:

“ **21.7.10 Wall piers and wall segments**

“ **21.7.10.1:** Wall piers not designed as part of a special moment frame shall have transverse reinforcement designed to satisfy the requirements of Sec. 21.7.10.2.

“**Exceptions:** This requirement need not be applied in the following conditions:

“1. Wall piers that satisfy Sec. 21.11, and

“2. Wall piers along a wall line within a story where other shear wall segments provide lateral support to the wall piers and such segments have a total stiffness of at least six times the sum of the stiffness of all the wall piers.

“ **21.7.10.2:** Transverse reinforcement with seismic hooks at both ends shall be designed to resist the shear forces determined from Sec. 21.4.5.1. Spacing of transverse reinforcement shall not exceed 6 in. (152 mm). Transverse reinforcement shall be extended beyond the pier clear height for at least 12 in. (304mm).

“**21.7.10.3** Wall segments with a horizontal length-to-thickness ratio less than 2.5 shall be designed as columns.”

9.2.2.4 Special structural walls constructed using precast concrete . Add a new Sec. 21.8.2 to ACI 318 as follows:

“**21.8.2** Wall systems not meeting the requirements of 21.8.1 shall be permitted if substantiating experimental evidence and analysis meets the requirements of Sec. 9. 6 of the 2003 NEHRP Recommended *Provisions*.”

9.2.2.5 Intermediate precast structural walls. Delete existing Sec. 21.13.3 of ACI 318 and replace with following:

“**21.13.3** Connections that are designed to yield shall be capable of maintaining 80 percent of their design strength at the deformation induced by design displacement, or shall use type 2 mechanical splices.

“**21.13.4** Elements of the connection that are not designed to yield shall develop at least $1.5 S_y$.”

“**21.13.5** Wall piers not designed as part of a moment frame shall have transverse reinforcement designed to resist the shear forces determined from Sec. 21.12.3. Spacing of transverse reinforcement shall not exceed 8 in., and (b) six times the diameter of the longitudinal reinforcement. Transverse reinforcement shall be extended beyond the pier clear height for at least 12 in.

Exception: The above requirement need not apply in the following situations:

1. Wall piers that satisfy Sec. 21.11, and
2. Wall piers along a wall line within a story where other shear wall segments provide lateral support to the wall piers and such segments have a total stiffness of at least six times the sum of the stiffnesses of all the wall piers.

“Wall segments with a horizontal length-to-thickness ratio less than 2.5 shall be designed as columns.”

9.2.2.6 Foundations. Delete Sec. 21.10.1.1 of ACI 318 and replace with following:

“ **21.10.1.1** Foundations resisting earthquake-induced forces or transferring earthquake-induced forces between a structure and the ground shall comply with requirements of 21.10 and other applicable provisions except as modified by Chapter 7 of the 2003 *NEHRP Recommended Provisions*.”

9.2.2.7 Frame members that are not part of the seismic-force-resisting system. Delete Sec.21.11.2.2 of ACI 318 and replace with following:

“ **21.11.2.2** . Members with factored gravity axial forces exceeding $A_g f_c' / 10$ shall satisfy 21.4.3, 21.4.4.1(c), 21.4.4.3, and 21.4.5. The maximum longitudinal spacing of ties shall be s_o for the full column height. The spacing, s_o , shall not be more than six diameters of the smallest longitudinal bar enclosed or 6 in. (152 mm), whichever is smaller. Lap splices of longitudinal reinforcement in such members need not satisfy 21.4.3.2 in structures where the seismic-force-resisting system does not include special moment frames.”

9.2.2.8 Anchoring to Concrete

9.2.2.8.1. Delete Sec. D.3.3.2 of ACI 318 and replace with following:

“**D.3.3.2** – In structures assigned to Seismic Design Category C, D, E or F, post-installed structural anchors for use under D.2.3 shall have passed the Simulated Seismic Tests of ACI 355.2.”

9.2.2.8.2. Delete Sec. D.3.3.3 of ACI 318 and replace with following:

“**D.3.3.3** – In structures assigned to Seismic Design Category C, D, E or F, the design strength of anchors shall be taken as $0.75 \phi N_n$ and $0.75 \phi V_n$, where ϕ is given in D 4.4 when the load combinations of Sec. 9.2 are used and in D 4.5 when the load combinations of Appendix C are used, and N_n and V_n are determined in accordance with D.4.1.”

9.2.2.8.3. Delete Sec. D.3.3.4 of ACI 318 and replace with following:

“**D 3.3.4** – In structures assigned to Seismic Design Category C, D, E or F, anchors shall be designed to be governed by tensile or shear strength of a ductile steel element, unless D.3.3.5 is satisfied.”

9.2.2.8.4. Delete Sec. D 3.3.5 of ACI 318 and replace with following:

“**D 3.3.5** – Instead of D 3.3.4, the attachment that the anchor is connecting to the structure shall be designed so that the attachment undergoes ductile yielding at a load level corresponding to anchor forces no greater than the design strength of anchors specified in D.3.3.3, or the minimum design strength of the anchors shall be at least 2.5 times the factored forces transmitted by the attachment.

9.3 SEISMIC DESIGN CATEGORY B

Structures assigned to Seismic Design Category B shall satisfy the requirements of Sec.21.2.1.2 of ACI 318 and this section.

9.3.1 Ordinary moment frames. Flexural members of all ordinary moment frames forming part of the seismic-force-resisting system shall be designed in accordance with Sec. 7.13.2 of ACI 318. For such elements, at least two main flexural reinforcing bars shall be provided continuously, top and bottom, throughout the beams and shall extend through or be developed within exterior columns or boundary elements.

Columns of ordinary moment frames having a clear-height-to-maximum-plan-dimension ratio of 5 or less shall be designed for shear in accordance with Sec. 21.12.3 of ACI 318.

9.4 SEISMIC DESIGN CATEGORY C

Structures assigned to Seismic Design Category C shall satisfy the requirements for Seismic Design Category B, Sec. 21.2.1.3 of ACI 318 and the additional requirements of this section.

9.4.1 Discontinuous members. Columns supporting reactions from discontinuous stiff members such as walls shall be designed for the seismic load effects defined in Sec. 4.2.2.2 and shall be provided with transverse reinforcement at the spacing s_v as defined in Sec. 2.12.5.2 of ACI 318 over their full height beneath the level at which the discontinuity occurs. This transverse reinforcement shall be extended above and below the column as required in Sec. 21.4.4.5 of ACI 318.

9.4.2 Plain concrete. Plain concrete members shall comply with the requirements of ACI 318 and the additional requirements and limitations of this section.

9.4.2.1 Walls. Ordinary and detailed plain concrete walls are not permitted.

Exception: In detached one- and two-family dwellings three stories or less in height constructed with stud bearing walls, plain concrete basement, foundation, or other walls below the base are permitted. Such walls shall have reinforcement in accordance with Sec. 22.6.6.5 of ACI 318.

9.4.2.2 Footings. Isolated footings of plain concrete supporting pedestals or columns are permitted provided the projection of the footing beyond the face of the supported member does not exceed the footing thickness.

Exception: In detached one- and two-family dwellings three stories or less in height constructed with stud bearing walls, the projection of the footing beyond the face of the supported member shall be permitted to exceed the footing thickness.

Plain concrete footings supporting walls shall be provided with no less than two continuous longitudinal reinforcing bars. Bars shall not be smaller than No. 4 (13 mm) and shall have a total area of not less than 0.002 times the gross cross-sectional area of the footing. For footings that exceed 8 in. in thickness, a minimum of one bar shall be provided at the top and bottom of the footing. For foundation systems consisting of plain concrete footing and plain concrete stemwall, a minimum of one bar shall be provided at the top of the stemwall and at the bottom the footing. Continuity of reinforcement shall be provided at corners and intersections.

Exceptions:

1. In detached one- and two-family dwellings three stories or less in height and constructed with stud bearing walls, plain concrete footings supporting walls shall be permitted without longitudinal reinforcement.
2. Where a slab-on-ground is cast monolithically with the footing, one No. 5 (16 mm) bar is permitted to be located at either the top or bottom of the footing.

9.4.2.3 Pedestals. Plain concrete pedestals shall not be used to resist lateral seismic forces.

9.5 SEISMIC DESIGN CATEGORIES D, E, AND F

Structures assigned to Seismic Design Category D, E, or F shall satisfy the requirements for Seismic Design Category C and Sec. 21.2.1.4 of ACI 318.

9.6 ACCEPTANCE CRITERIA FOR SPECIAL PRECAST STRUCTURAL WALLS BASED ON VALIDATION TESTING**9.6.1 Notation**

Symbols additional to those in Chapter 21 of ACI 318 are defined.

E_{max} = maximum lateral resistance of test module determined from test results (forces or moments).

E_n = nominal lateral resistance of test module calculated using specified geometric properties of test members, specified yield strength of reinforcement, specified compressive strength of concrete, a strain compatibility analysis or deformation compatibility analysis for flexural strength and a strength reduction factor ϕ of 1.0.

E_{nt} = Calculated lateral resistance of test module using the actual geometric properties of test members, the actual strengths of reinforcement, concrete, and coupling devices, obtained by testing per 9.6.7.7, 9.6.7.8, and 9.6.7.9; and a strength reduction factor ϕ of 1.0.

θ = drift ratio.

β = relative energy dissipation ratio.

9.6.2 Definitions

Definitions additional to those in Chapter 21 of ACI 318 are defined.

9.6.2.1 Coupling Elements. Devices or beams connecting adjacent vertical boundaries of structural walls and used to provide stiffness and energy dissipation for the connected assembly greater than the sum of those provided by the connected walls acting as separate units.

9.6.2.2 Drift ratio. Total lateral deformation of the test module divided by the height of the test module.

9.6.2.3 Global toughness. The ability of the entire lateral force resisting system of the prototype structure to maintain structural integrity and continue to carry the required gravity load at the maximum lateral displacements anticipated for the ground motions of the maximum considered earthquake.

9.6.2.4 Prototype structure. The concrete wall structure for which acceptance is sought.

9.6.2.5 Relative energy dissipation ratio. Ratio of actual to ideal energy dissipated by test module during reversed cyclic response between given drift ratio limits, expressed as the ratio of the area of the hysteresis loop for that cycle to the area of the circumscribing parallelograms defined by the initial stiffnesses during the first cycle and the peak resistances during the cycle for which the relative energy dissipation ratio is calculated Sec. 9.6.9.1.3.

9.6.2.5 Test module. Laboratory specimen representing the critical walls of the prototype structure. See 9.6.5.

9.6.3 Scope and general requirements

9.6.3.1 These provisions define minimum acceptance criteria for new precast structural walls, including coupled precast structural walls, designed for regions of high seismic risk or for structures assigned to high seismic performance or design categories, where acceptance is based on experimental evidence and mathematical analysis.

9.6.3.2. These provisions are applicable to precast structural walls, coupled or uncoupled, with height to length, h_w/l_w , ratios equal to or greater than 0.5. These provisions are applicable for either prequalifying precast structural walls for a specific structure or prequalifying a new precast wall type for construction in general.

9.6.3.3. Precast structural walls shall be deemed to have a response that is at least equivalent to the response of monolithic structural walls designed in accordance with Sec.21.2 and 21.7 of ACI 318, and the corresponding structural walls of the prototype structure shall be deemed acceptable, when all of the conditions in Sec. 9.6.3.3.1 through 9.6.3.3.5 are satisfied.

9.6.3.3.1. The prototype structure satisfies all applicable requirements of these provisions and of ACI 318 except Sec.21.7.

9.6.3.3.2. Tests on wall modules satisfy the conditions in Sec. 9.6.4 and 9.6.9.

9.6.3.3.3. The prototype structure is designed using the design procedure substantiated by the testing program.

9.6.3.3.4. The prototype structure is designed and analyzed using effective initial properties consistent with those determined in accordance with Sec. 9.6.7.11, and the prototype structure meets the drift limits of these provisions.

9.6.3.3.5. The structure as a whole, based on the results of the tests of Sec. 9.6.3.3.2 and analysis, is demonstrated to have adequate global toughness (the ability to retain its structural integrity and support its specified gravity loads) through peak displacements equal to or exceeding the story-drift ratios specified in Sec.9.6.7.4, 9.6.7.5 or 9.6.7.6, as appropriate.

9.6.4 Design procedure

9.6.4.1. Prior to testing, a design procedure shall be developed for the prototype structure and its walls. That procedure shall account for effects of material non-linearity, including cracking, deformations of members and connections, and reversed cyclic loading. The design procedure shall include the procedures specified in Sec. 9.6.4.1.1 through 9.6.4.1.4 and shall be applicable to all precast structural walls, coupled and uncoupled, of the prototype structure.

9.6.4.1.1. Procedures shall be specified for calculating the effective initial stiffness of the precast structural walls, and of coupled structural walls, that are applicable to all the walls of the prototype structure.

9.6.4.1.2. Procedures shall be specified for calculating the lateral strength of the precast structural walls, and of coupled structural walls, applicable to all precast walls of the prototype structure.

9.6.4.1.3. Procedures shall be specified for designing and detailing the precast structural walls so that they have adequate ductility capacity. These procedures shall cover wall shear strength, sliding shear strength, boundary tie spacing to prevent bar buckling, concrete confinement, reinforcement strain, and any other actions or elements of the wall system that can affect ductility capacity.

9.6.4.1.4. Procedures shall be specified for determining that an undesirable mechanism of nonlinear response, such as a story mechanism due to local buckling of the reinforcement or splice failure, or overall instability of the wall, does not occur.

9.6.4.2. The design procedure shall be used to design the test modules and shall be documented in the test report.

9.6.4.3. The design procedure used to proportion the test specimens shall define the mechanism by which the system resists gravity and earthquake effects and shall establish acceptance values for sustaining that mechanism. Portions of the mechanism that deviate from code requirements shall be contained in the test specimens and shall be tested to determine acceptance values.

9.6.5 Test Modules

9.6.5.1. At least two modules shall be tested. At least one module shall be tested for each limiting engineering design criteria (shear, axial load and flexure) for each characteristic configuration of precast structural walls, including intersecting structural walls or coupled structural walls. If all the precast walls of the structure have the same configuration and the same limiting engineering design criterion, then two modules shall be tested. Where intersecting precast wall systems are to be used, the response for the two orthogonal directions shall be tested.

9.6.5.2. Where the design requires the use of coupling elements, those elements shall be included as part of the test module.

9.6.5.3. Modules shall have a scale large enough to represent the complexities and behavior of the real materials and of the load transfer mechanisms in the prototype walls and their coupling elements, if any. Modules shall have a scale not less than one half and shall be full-scale if the validation testing has not been preceded by an extensive analytical and experimental development program in which critical details of connections are tested at full scale.

9.6.5.4. The geometry, reinforcing details, and materials properties of the walls, connections, and coupling elements shall be representative of those to be used in the prototype structure.

9.6.5.5. Walls shall be at least two panels high unless the prototype structure is one for which a single panel is to be used for the full height of the wall.

9.6.5.6. Where precast walls are to be used for bearing wall structures, as defined in SEI/ASCE 7-02, the test modules shall be subject during lateral loading to an axial load stress representative of that anticipated at the base of the wall in the prototype structure.

9.6.5.7. The geometry, reinforcing, and details used to connect the precast walls to the foundation shall replicate those to be used in the prototype structure.

9.6.5.8. Foundations used to support the test modules shall have geometric characteristics, and shall be reinforced and supported, so that their deformations and cracking do not affect the performance of the modules in a way that would be different than in the prototype structure.

9.6.6 Testing Agency. Testing shall be carried out by an independent testing agency approved by the Authority Having Jurisdiction. The testing agency shall perform its work under the supervision of a registered design professional experienced in seismic structural design.

9.6.7 Test Method

9.6.7.1 Test modules shall be subjected to a sequence of displacement-controlled cycles representative of the drifts expected under earthquake motions for the prototype structure. If the module consists of coupled walls, approximately equal drifts (within 5 percent of each other) shall be applied to the top of each wall and at each floor level. Cycles shall be to predetermined drift ratios as defined in Sec. 9.6.7.2 through 9.6.7.6.

9.6.7.2 Three fully reversed cycles shall be applied at each drift ratio.

9.6.7.3 The initial drift ratio shall be within the essentially linear elastic response range for the module. See 9.6.7.11. Subsequent drift ratios shall be to values not less than 5/4 times, and not more than 3/2 times, the previous drift ratio.

9.6.7.4 For uncoupled walls, testing shall continue with gradually increasing drift ratios until the drift ratio in percent equals or exceeds the larger of : (a) 1.5 times the drift ratio corresponding to the design

displacement or (b) the following value:

$$0.80 \leq 0.67 \left[h_w / l_w \right] + 0.5 \leq 2.5 \quad (9.6-1)$$

where:

h_w = height of entire wall for prototype structure, in.

l_w = length of entire wall in direction of shear force, in.

9.6.7.5 For coupled walls, h_w/l_w in Eq. 9.6.1 shall be taken as the smallest value of h_w/l_w for any individual wall of the prototype structure.

9.6.7.6 Validation by testing to limiting drift ratios less than those given by Eq. 9.6.1 shall be acceptable provided testing is conducted in accordance with this document to drift ratios equal or exceeding of those determined for the response to a suite of nonlinear time history analyses conducted in accordance with Sec. 9.5.8 of SEI/ASCE 7-02 for maximum considered ground motions.

9.6.7.7 Actual yield strength of steel reinforcement shall be obtained by testing coupons taken from the same reinforcement batch as used in the test module. Two tests, conforming to the ASTM specifications cited in Sec. 3.5 of ACI 318, shall be made for each reinforcement type and size.

9.6.7.8 Actual compressive strength of concrete shall be determined by testing of concrete cylinders cured under the same conditions as the test module and tested at the time of testing the module. Testing shall conform to the applicable requirements of Sec.5.6.1 through 5.6.4 of ACI 318.

9.6.7.9 Where strength and deformation capacity of coupling devices does not depend on reinforcement tested as required in Sec. 9.6.7.7, the effective yield strength and deformation capacity of coupling devices shall be obtained by testing independent of the module testing.

9.6.7.10 Data shall be recorded from all tests such that a quantitative interpretation can be made of the performance of the modules. A continuous record shall be made of test module drift ratio versus applied lateral force, and photographs shall be taken that show the condition of the test module at the peak displacement and after each key testing cycle.

9.6.7.11 The effective initial stiffness of the test module shall be calculated based on test cycles to a force between $0.6E_{nt}$ and $0.9E_{nt}$, and using the deformation at the strength of $0.75E_{nt}$ to establish the stiffness.

9.6.8. Test Report

9.6.8.1 The test report shall contain sufficient evidence for an independent evaluation of all test procedures, design assumptions, and the performance of the test modules. As a minimum, all of the information required by Sec. 9.6.8.1.1 through 9.6.8.1.11 shall be provided.

9.6.8.1.1 A description shall be provided of the design procedure and theory used to predict test module strength, specifically the test module nominal lateral resistance, E_n , and the test module actual lateral resistance E_m .

9.6.8.1.2 Details shall be provided of test module design and construction, including fully dimensioned engineering drawings that show all components of the test specimen.

9.6.8.1.3 Details shall be provided of specified material properties used for design, and actual material properties obtained by testing in accordance with Sec. 9.6.7.7.

9.6.8.1.4 A description shall be provided of test setup, including fully dimensioned diagrams and photographs.

9.6.8.1.5 A description shall be provided of instrumentation, its locations, and its purpose.

9.6.8.1.6 A description and graphical presentation shall be provided of applied drift ratio sequence.

9.6.8.1.7 A description shall be provided of observed performance, including photographic documentation, of the condition of each test module at key drift ratios including, (as applicable), the ratios corresponding to first flexural cracking or joint opening, first shear cracking, and first crushing of the concrete for both positive and negative loading directions, and any other significant damage events that occur. Photos shall be taken at peak drifts and after the release of load.

9.6.8.1.8 A graphical presentation shall be provided of lateral force versus drift ratio response.

9.6.8.1.9 A graphical presentation shall be provided of relative energy dissipation ratio versus drift ratio.

9.6.8.1.10 A calculation shall be provided of effective initial stiffness for each test module as observed in the test and as determined in accordance with Sec. 9.6.7.11 and a comparison made as to how accurately the design procedure has been able to predict the measured stiffness. The design procedure shall be used to predict the overall structural response and a comparison made as to how accurately that procedure has been able to predict the measured response.

9.6.8.1.11 The test date, report date, name of testing agency, report author(s), supervising registered design professional, and test sponsor shall be provided.

9.6.9 Test module acceptance criteria

9.6.9.1 The test module shall be deemed to have performed satisfactorily when all of the criteria Sec. 9.6.9.1.1 through 9.6.9.1.3 are met for both directions of in-plane response. If any test module fails to pass the validation testing required by these provisions for any test direction, then the wall system has failed the validation testing.

9.6.9.1.1 Peak lateral strength obtained shall be at least $0.9E_{nt}$ and not greater than $1.2 E_{nt}$.

9.6.9.1.2 In cycling up to the drift level given by Sec. 9.6.7.4 through 9.6.7.6, fracture of reinforcement or coupling elements, or other significant strength degradation, shall not occur. For a given direction, peak lateral strength during any cycle of testing to increasing displacement shall not be less than 0.8 times E_{max} for that direction.

9.6.9.1.3 For cycling at the given drift level for which acceptance is sought in accordance with Sec. 9.6.7.4, 9.6.7.5 or 9.6.7.6, as applicable, the parameters describing the third complete cycle shall have satisfied the following:

1. The relative energy dissipation ratio shall have been not less than 1/8; and
2. The secant stiffness between drift ratios of -1/10 and +1/10 of the maximum applied drift shall have been not less than 0.10 times the stiffness for the initial drift ratio specified in Sec. 9.6.7.3.

9.6.10. Reference

Minimum Design Loads on Buildings and Other Structures Standards Committee, "Minimum Design Loads for Buildings and Other Structures (SEI/ASCE 7-02) - Earthquake Loads," Structural Engineering Institute, American Society of Civil Engineers, Reston, VA, 2002.

This page is intentionally left blank.

Appendix to Chapter 9

UNTOPPED PRECAST DIAPHRAGMS

PREFACE: Reinforced concrete diaphragms constructed using untopped precast concrete elements are permitted in the text of the *Provisions* for Seismic Design Categories A, B, and C but not for Categories D, E, and F. For the latter, the precast elements must be topped and the topping designed as the diaphragm. For resisting seismic forces, a composite topping slab cast in place on precast concrete elements must have a thickness of not less than 2 in. (51 mm) and a topping slab not relying on composite action with the precast elements must have a thickness of not less than 2-1/2 in. (64 mm).

There are two principal reasons why a framework for the design of untopped diaphragms for Seismic Design Categories D, E, and F may be desirable. One relates to the performance of topping slab diaphragms in recent earthquakes and the other to durability considerations. The 1997 *Provisions* incorporated ACI 318-95 for which the provisions for topping slab diaphragms on precast elements were essentially the same as those in ACI 318-89. In the 1994 Northridge earthquake, performance was poor for structures where demands on the topping slab diaphragms on precast elements were maximized and the structures had been designed using ACI 318-89. The topping cracked along the edges of the precast elements and the welded wire reinforcement crossing those cracks fractured. The diaphragms became the equivalent of an untopped diaphragm with the connections between precast concrete elements, the connectors, and the chords not detailed for that condition. Another problem found with topping slab diaphragms was that the chords often utilized large diameter bars, grouped closely together at the topping slab edge. Under severe loading, these unconfined chord bars lost bond with the concrete and thus lost the ability to transfer seismic forces.

ACI 318-99 was significantly revised for structural diaphragms to add new detailing provisions in response to the poor performance of some cast-in-place composite topping slab diaphragms during the 1994 Northridge earthquake. New code and commentary sections 21.7 and R21.7 were added to Chapter 21. Cast-in-place composite topping slabs and cast-in-place topping slab diaphragms were permitted by ACI 318-99, but no mention was made of untopped precast diaphragms. The diaphragm provisions of ACI 318-99 were carried over unchanged into ACI 318-02 and placed in Sec. 21.9 rather than Sec. 21.7, where they had been in ACI 318-99.

The evidence from the recently completed PRESSS 5-story building test (M. J. NM. Priestley, D. Sritharan, J. R. Conley, and S. Pampanin, "Preliminary Results and Conclusions from the PRESSS Five-Story Precast Concrete Test Building," *PCI Journal*, Vol. 44, No. 6, November-December 1999), from Italian and English tests (K. S. Elliott, G. Davies, and W. Omar, "Experimental Hollow-cored Slabs Used as Horizontal Floor Diaphragms," *The Structural Engineer*, Vol. 70, No. 10, May 1992, pp. 175-187; M. Menegotto, "Seismic Diaphragm Behavior of Untopped Hollow-Core Floors," *Proceedings, FIP Congress*, Washington, D. C., May 1994), and from the 1999 Turkey earthquake is that such diaphragms can perform satisfactorily if they are properly detailed and if they and their connections remain elastic under the force levels the diaphragms experience. However, further additions to the ACI 318-02 requirements are needed if such performance is to be achieved. In particular, the diaphragm design forces and detailing requirements for ductility of connections (as a second line of defense) require revision.

These *Provisions* incorporate ACI 318-02, which recognizes that for topping slab diaphragms a controlling condition is the in-plane shear in concrete along the edges of the precast elements. Ductility is provided by requiring that the topping slab reinforcement crossing those edges be spaced at not less than 10 inches on center. While those requirements are based on the best

available engineering judgment and evidence, they have not as yet been proven to provide adequate safety either by laboratory testing or field performance. Due to the dimensions of the precast element relative to the thickness of the topping slab, it may well be prudent to have seismic provisions for diaphragms incorporating precast elements controlled by untopped diaphragm considerations and to have those provisions modified for topped diaphragms. Further, in geographic areas where corrosive environments are a significant concern, the construction of untopped diaphragms using “pre-topped” precast elements rather than topped elements, can be desirable.

This appendix provides a compilation of current engineering judgment on a framework for seismic provisions for untopped diaphragms. That framework does not, however, adequately address all the concerns needed for its incorporation into the text of the *Provisions*. This appendix proposes that a diaphragm composed of untopped elements be designed to remain elastic, and that the connectors be designed for limited ductility, in the event that design forces are exceeded during earthquake response and some inelastic action occurs where the demands on the diaphragm are maximized. By contrast, for all other systems assigned to Seismic Design Category D, E, or F, the philosophy of the *Provisions* is to require significant ductility. For the approach of this appendix, critical issues are how best to define:

The design forces for the diaphragm so that they are large enough to result in essentially elastic behavior when the demands on the diaphragm are maximized, or whether that criterion is even achievable;

1. The relation between the response of the diaphragm, its dimensions, and the ductility demands on the connectors;
2. The ductility changes that occur for connectors under various combinations of in-plane and out-of-plane shear forces, and tensile and compressive forces;
3. The boundary conditions necessary for testing and for application of the loading for the validation testing of connectors; and
4. The constraints on connector performance imposed by their size relative to the size of the diaphragm elements.

The use of this appendix as a framework for laboratory testing, analyses of the performance of diaphragms in past earthquakes, analytical studies, and trial designs is encouraged. Users should also consult the *Commentary* for guidance and references. Please direct all feedback on this appendix and its commentary to the BSSC.

In this appendix, the untopped precast diaphragm is designed to remain elastic by requiring that its design forces be based on Eq. 4.6-2, and be not less than a minimum value dependent upon the seismic response coefficient, with both values multiplied by the overstrength and redundancy factors associated with the seismic-force-resisting system. In addition, the connections are required to be able to perform in a ductile manner in the unlikely event that the diaphragm is forced to deform inelastically.

A9.1 GENERAL

A9.1.1 Scope. This appendix provides guidelines for the design of diaphragms using untopped precast concrete elements for Seismic Design Categories D, E, and F.

A9.1.2 References

- | | |
|-------------|---|
| ACI 318 | <i>Building Code Requirements for Structural Concrete</i> , American Concrete Institute, 2002 |
| ACI T1.1-01 | <i>Acceptance Criteria for Moment Frames Based on Structural Testing</i> , American Concrete Institute, 2001. |

ATC-24 *Guidelines for Seismic Testing of Components of Steel Structures*, Applied Technology Council, 1992.

A9.1.3 Definitions

Boundary elements: See Sec. 2.1.3.

Chord: See Sec. 12.1.3.

Collector: See Sec. 4.1.3.

Component: See Sec. 1.1.4.

Design strength: See Sec. 4.1.3.

Diaphragm: See Sec. 4.1.3.

Drag strut: See Sec. 4.1.3.

Nominal strength: See Sec. 4.1.3.

Quality assurance plan: See Sec. 2.1.3.

Required strength: See Sec. 4.1.3.

Seismic Design Category: See Sec. 1.1.4.

Seismic-force-resisting system: See Sec. 1.1.4.

Structure: See Sec. 1.1.4.

Untopped precast diaphragm: A diaphragm consisting of precast concrete components that does not have a structural topping meeting the requirements of these *Provisions*.

A9.1.4 Notation.

C_S See Sec. 5.1.3.

F_{px} See Sec. 4.1.4.

w_{px} See Sec. 4.1.4.

ρ See Sec. 4.1.4.

ϕ See Sec. 5.1.3.

Ω_0 See Sec. 4.1.4.

A9.2 DESIGN REQUIREMENTS

Untopped precast floor or roof diaphragms in Seismic Design Category D, E, or F shall satisfy the requirements of this section.

A9.2.1 Configuration. Untopped diaphragms shall not be permitted in structures with plan irregularity Type 4 as defined in Table 4.3-2. For diaphragms in structures having plan irregularities Type 1a, 1b, 2, or 5 as defined in Table 4.3-2, the analysis required by Sec. A9.2.2 shall explicitly include the effect of such irregularities as required by Sec. 4.6.

A9.2.2 Diaphragm demand. Rational elastic models shall be used to determine the in-plane shear, tension, and compression forces acting on connections that cross joints. For any given joint, the connections shall resist the total shear and total moment acting on the joint assuming an elastic distribution of stresses.

The diaphragm design force shall be taken as the lesser of the following two criteria:

1. $\rho\Omega_0$ times the F_{px} value calculated from Eq. 4.6-2, but not less than $\rho\Omega_0 C_S w_{px}$; or
2. A shear force corresponding to 1.25 times that corresponding to yielding of the seismic-force-

resisting system, calculated using ϕ value(s) equal to unity.

In item 1 above, the overstrength factor, Ω_o , shall be that for the seismic-force-resisting system as specified in Table 4.3-1, the redundancy factor, ρ , shall be as specified in *Provisions* Sec. 4.3.3, and the seismic response coefficient, C_s , shall be as determined in accordance with *Provisions* Sec. 5.2.1.1.

A9.2.3 Mechanical connections. Mechanical connections shall have design strength, for the body of the connector, greater than the factored forces determined in accordance with Sec. A9.2.2.

Mechanical connections used at joints shall be shown by analysis and testing, under reversed cyclic loading, to develop adequate capacity in shear, tension, and compression (or a combination of these effects) to resist the demands calculated in accordance with Sec. A9.2.2. Testing of connections and evaluation of results shall be made in accordance with the principles specified in ACI T1.1 and ATC-24.

When subjected to the specified loading, connections shall develop ductility ratios equal to or greater than 2.0. The behavior of connection embedments shall be governed by steel yielding and not by fracture of concrete or welds.

Connections shall be designed using the strength reduction factors, ϕ , specified in ACI 318. Where the ϕ factor is modified by Sec. 9.3.4 of ACI 318, the modified value shall be used for the diaphragm connections.

Where the design relies on friction in grouted joints for shear transfer across the joints, shear friction resistance shall be provided by mechanical connectors or reinforcement.

A9.2.4 Cast-in-place strips. Cast-in place strips shall be permitted in the end or edge regions of precast components as chords or collectors. These strips shall meet the requirements for topping slab diaphragms. The reinforcement in the strips shall comply with Sec. 21.9.8.2 and 21.9.8.3 of ACI 318.

A9.2.5 Deformation compatibility. In satisfying the compatibility requirement of Sec. 4.5.3, the additional deformation that results from the diaphragm flexibility shall be considered. The assumed flexural and shear stiffness properties of the elements that are part of the seismic-force-resisting system shall not exceed one-half of the gross-section properties, unless confirmed by a rational, cracked-section analysis.

A9.2.6 Beam connections. Ties to supporting members and bearing lengths shall satisfy the requirements for design force and geometry characteristics specified for the connections in Sec. 21.11.4 of ACI 318.

A9.2.7 Quality assurance. Diaphragms shall have a quality assurance plan in accordance with Sec. 2.2.1 of these *Provisions*.

Chapter 10

COMPOSITE STEEL AND CONCRETE STRUCTURE DESIGN REQUIREMENTS

10.1 GENERAL

10.1.1 Scope. The design, construction, and quality of composite steel and concrete components that resist seismic forces shall comply with the requirements of the references in Sec. 10.1.2 and the additional requirements of this chapter.

10.1.2 References. The following documents shall be used as specified in this chapter.

ACI 318 *Building Code Requirements for Structural Concrete*, American Concrete Institute, 2002, excluding Appendix C (Alternative Load and Strength Reduction Factors) and Chapter 22 (Structural Plain Concrete).

AISC LRFD *Load and Resistance Factor Design Specification for Structural Steel Buildings*, American Institute of Steel Construction, 1999.

AISC Seismic *Seismic Provisions for Structural Steel Buildings*, Parts I and II, American Institute of Steel Construction, 2002.

10.1.3 Definitions

Seismic Design Category: See Sec. 1.1.4.

Structure: See Sec. 1.1.4.

10.1.4 Notation

R See Sec. 4.1.4.

10.2 GENERAL DESIGN REQUIREMENTS

An *R* factor as set forth in Table 4.3-1 for the appropriate composite steel and concrete system is permitted when the structure is designed and detailed in accordance with the provisions of AISC Seismic, Part II.

10.3 SEISMIC DESIGN CATEGORIES B AND C

For structures assigned to Seismic Design Category B or C, the design of such systems shall comply with the requirements of AISC Seismic, Part II.

10.4 SEISMIC DESIGN CATEGORIES D, E, AND F

Composite structures assigned to Seismic Design Category D, E, or F are permitted, subject to the limitations in Table 4.3-1, where substantiating evidence is provided to demonstrate that the proposed system will perform as intended by AISC Seismic, Part II. The substantiating evidence shall be subject to approval by the authority having jurisdiction. Where composite elements or connections are required to sustain inelastic deformations, the substantiating evidence shall be based upon cyclic testing.

10.5 MODIFICATIONS TO AISC SEISMIC, PART II

10.5.1 Changes to nomenclature. Change throughout the document “Seismic Force Resisting System” to “Seismic Load Resisting System.”

10.5.2 Changes to definitions in the AISC Glossary.

“Composite Beam. A structural steel beam that is in contact with and acts compositely with reinforced concrete via bond or shear connectors.

Encased Composite Beam. A composite beam that is completely enclosed in reinforced concrete.

Unencased Composite Beam. A composite beam wherein the steel section is not completely enclosed in reinforced concrete and relies on mechanical connectors for composite action with a reinforced slab or slab on metal deck.”

10.5.3 Changes to Section 1 - SCOPE

“These Provisions shall be applied in conjunction with the AISC *Load and Resistance Factor Design (LRFD) Specification for Structural Steel Buildings*, hereinafter referred to as the LRFD Specification. The applicable requirements in Part I shall be used for the design of structural steel components in composite Seismic Load Resisting Systems. The applicable requirements in ACI 318 shall be used for the design of reinforced concrete components in composite Seismic Load Resisting Systems, except as modified in these provisions. The applicable requirements in Part II shall be used for the design of composite components in composite Seismic Load Resisting Systems. When the design is based upon elastic analysis, the stiffness properties of the component members of composite systems shall reflect their condition at the onset of significant yielding of the building.”

10.5.4 Changes to Section 2 - REFERENCED SPECIFICATIONS, CODES AND STANDARDS

“The documents referenced in these provisions shall include those listed in Part I, Section 2, with the following additions and modifications:

American Society of Civil Engineers, *Standard for the Structural Design of Composite Slabs*, ASCE 3-91

American Welding Society, AWS D1.4-98 – *Standard for the Welding of Reinforcement*”

10.5.5 Changes to Section 3 - SEISMIC DESIGN CATEGORIES

“The required strength and other seismic provisions for Seismic Design Categories (SDCs), Seismic Use Groups or Seismic Zones and the limitations on height and irregularity shall be as specified in the Applicable Building Code (see Glossary).

10.5.6 Changes to Section 4 - LOADS, LOAD COMBINATIONS AND NOMINAL STRENGTHS

“The loads and load combinations shall be as stipulated by the Applicable Building Code. Where Amplified Seismic Loads are required by these provisions, the horizontal earthquake load E (as defined in the Applicable Building Code) shall be multiplied by the overstrength factor Ω_0 prescribed by the Applicable Building Code. In the absence of a specific...”

10.5.7 Changes to Section 5.2 - Concrete and Steel Reinforcement

“Concrete and steel reinforcement used in composite components in composite Seismic Load Resisting Systems shall meet the requirements in ACI 318, Sections 25.4 through 25.8.

Exception: Concrete and steel reinforcement used in the composite Ordinary Seismic Load Resisting Systems described in Sections 11, 12, and 15 shall meet the requirements in AISC LRFD Chapter I and ACI 318, excluding Chapter 21.”

10.5.8 Changes to Section 6.3 - COMPOSITE BEAMS

“Composite Beams shall meet the requirements in LRFD Specification Chapter I. Composite Beams that are part of C-SMF shall also meet the requirements of Section 9.3.”

10.5.9 Changes to Section 6.4 - Reinforced-Concrete-Encased Composite Columns

“This Section is applicable to columns that meet the limitations in LRFD Specification Section I2.1.

Such columns shall meet the requirements in LRFD Specification Chapter I, except as modified in this Section. Additional requirements, as specified for intermediate and special seismic systems in Sections 6.4b and 6.4c, shall apply as required in the descriptions of the composite seismic systems in Sections 8 through 17.

Columns that consist of reinforced-concrete-encased structural steel sections shall meet the requirements for reinforced concrete columns in ACI 318 except as modified for:

- (1) The steel shape shear connectors in Section 6.4a.2
- (2) The contribution of the reinforced-concrete-encased structural steel section to the strength of the column as provided in ACI 318.
- (3) The seismic requirements for reinforced concrete columns as specified in the description of the composite seismic systems in Sections 8 through 17.”

10.5.10 Changes to Section 6.4a - Ordinary Seismic System Requirements

“(5)Splices and end bearing details for reinforced-concrete-encased composite columns in ordinary systems shall meet the requirements in the LRFD Specification and ACI 318 Section 7.8.2. The design for intermediate and special systems shall also comply with ACI 318-02 Sections 21.2.6-7 and 21.10. The design shall consider any adverse behavioral effects due to abrupt changes in either the member stiffness or nominal tensile strength. Such locations shall include transitions to reinforced concrete sections without embedded structural steel members, transitions to bare structural steel sections, and column bases.”

10.5.11 Changes to Section 6.5 - CONCRETE-FILLED COMPOSITE COLUMNS

“This Section is applicable to columns that meet the limitations in LRFD Specification Section I2.1. Such columns shall be designed to meet the requirements in LRFD Specification Chapter I, except as modified in this Section.

- 6.5a.** The design shear strength of the composite column shall be the design shear strength of the structural steel section alone.
- 6.5b.** In addition to the requirements in Section 6.5a, in the special seismic systems described in Sections 9, 13 and 14, the design forces and column splices for concrete-filled composite columns shall also meet the requirements in Part I Section 8.
- 6.5c.** Concrete-filled composite columns used in C-SMF shall meet the following requirements in addition to those in Sections 6.5a. and 6.5b:
 1. The minimum required shear strength of the column shall meet the requirements in ACI 318 Section 21.4.5.1.
 2. The strong-column/weak-beam design requirements in Section 9.5 shall be met. Column bases shall be designed to sustain inelastic flexural hinging
 3. The minimum wall thickness of concrete-filled rectangular HSS shall equal

$$b\sqrt{F_y/(2E_s)} \quad (6-3)$$

for the flat width b of each face, where b is as defined in LRFD Specification Table B5.1, unless adequate means to prevent local buckling of the steel shape is demonstrated by tests or analysis.”

10.5.12 Changes to Section 6.5a - CONCRETE-FILLED COMPOSITE COLUMNS

“**6.5a.** The design shear strength of the composite column shall be the design shear strength of the structural steel section alone, based on its effective shear area. The concrete shear capacity may be used in conjunction the shear strength from the steel shape provided the design includes an appropriate load transferring mechanism. “

10.5.13 Changes to Section 7.3 - **NOMINAL STRENGTH OF CONNECTIONS**

“The nominal strength of connections in composite structural systems shall be determined on the basis of rational models that satisfy both equilibrium of internal forces and the strength limitation of component materials and elements based upon potential limit states. Unless the connection strength is determined by analysis and testing, the models used for analysis of connections shall meet the requirements in Sections 7.3a through 7.3e.

7.3a. When required, force shall be transferred between structural steel and reinforced concrete through direct bearing of headed shear studs or suitable alternative devices, by other mechanical means, by shear friction with the necessary clamping force provided by reinforcement normal to the plane of shear transfer, or by a combination of these means. Any potential bond strength between structural steel and reinforced concrete shall be ignored for the purpose of the connection force transfer mechanism. The contribution of different mechanism can be combined only if the stiffness and deformation capacity of the mechanisms is compatible.

The nominal bearing and shear-friction strengths shall meet the requirements in ACI 318 Chapters 10 and 11.

7.3b. The required strength of structural steel components in composite connections shall not exceed the design strengths as determined in Part I and the LRFD Specification. Structural steel elements that are encased in confined reinforced concrete are permitted to be considered to be braced against out-of-plane buckling. Face Bearing Plates consisting of stiffeners between the flanges of steel beams are required when beams are embedded in reinforced concrete columns or walls unless tests or analysis demonstrates otherwise.

7.3c. The nominal shear strength of reinforced-concrete-encased steel panel-zones in beam-to-column connections shall be calculated as the sum of the nominal strengths of the structural steel and confined reinforced concrete shear elements as determined in Part I Section 9.3 and ACI 318 Section 21.5, respectively.

7.3d. Reinforcement shall be provided to resist all tensile forces in reinforced concrete components of the connections. Additionally, the concrete shall be confined with transverse reinforcement. All reinforcement shall be fully developed in tension or compression, as appropriate, beyond the point at which it is no longer required to resist the forces. Development lengths shall be determined in accordance with ACI 318 Chapter 12. Additionally, development lengths for the systems described in Sections 9, 13, 14, 16 and 17 shall meet the requirements in ACI 318 Section 21.5.4. Connections shall meet the following additional requirements:

1. When the slab transfers horizontal diaphragm forces, the slab reinforcement shall be designed and anchored to carry the in-plane tensile forces at all critical sections in the slab, including connections to collector beams, columns, braces and walls.
2. For connections between structural steel or composite beams and reinforced concrete or reinforced-concrete-encased composite columns, transverse hoop reinforcement shall be provided in the connection region to meet the requirements in ACI 318 Section 21.5, except for the following modifications:
 - a. Structural steel sections framing into the connections are considered to provide confinement over a width equal to that of face bearing stiffener plates welded to the beams between the flanges.
 - b. Lap splices are permitted for perimeter ties when confinement of the splice is provided by Face Bearing Plates or other means that prevents spalling of the concrete cover in the systems described in Sections 10, 11, 12 and 15.
3. The longitudinal bar sizes and layout in reinforced concrete and composite columns shall be detailed to minimize slippage of the bars through the beam-to-column connection due to high force transfer associated with the change in column moments over the height of the connection.”

10.5.14 Changes to Section 8.2 - COLUMNS

“Structural steel columns shall meet the requirements in Part I Section 8 and the LRFD Specification.”

10.5.15 Changes to Section 8.3 - COMPOSITE BEAMS

“Composite beams shall be unencased, fully composite, and shall meet the requirements in LRFD Specification Chapter I, *except I.2*. For the purposes of frame analysis, the stiffness of beams shall be determined with an effective moment of inertia of the composite section that accounts for the negative and positive moments along the composite beams.”

10.5.16 Changes to Section 8.4 - Partially Restrained (PR) Moment Connections

“The required strength for the beam-to-column PR moment connections shall be determined using strength load combinations considering the effects of connection flexibility and second-order moments. In addition, composite connections shall have a nominal strength that is at least equal to 50 percent of $R_y M_p$, where M_p is the nominal plastic flexural strength of the connected structural steel beam ignoring composite action. Connections shall meet the requirements in Section 7 and shall have a minimum inelastic interstory drift angle of 0.025 radians and a total interstory drift angle of 0.04 radians that is substantiated by cyclic testing as described in Part I Section 9.2a.”

10.5.17 Changes to Section 9.3 - BEAMS

“Composite beams that are part of C-SMF as described in Section 9 shall also meet the following requirements:

1. The distance from the maximum concrete compression fiber to the plastic neutral axis shall not exceed:

$$\frac{Y_{con} + d_b}{1 + \left(\frac{1700F_y}{E_s} \right)}$$

where

Y_{con} = distance from the top of the steel beam to the top of concrete, in.

d_b = depth of the steel beam, in.

F_y = specified minimum yield strength of the steel beam, ksi.

E_s = elastic modulus of the steel beam, ksi.

2. Beam flanges shall meet the requirements in Part I Section 9.4, except when fully reinforced-concrete-encased compression elements have a reinforced concrete cover of at least 2 in. and confinement is provided by hoop reinforcement in regions where plastic hinges are expected to occur under seismic deformations. Hoop reinforcement shall meet the requirements in ACI 318 Section 21.3.3.

Neither structural steel nor composite trusses are permitted as flexural members to resist seismic loads in C-SMF unless it is demonstrated by testing and analysis that the particular system provides adequate ductility and energy dissipation capacity.”

10.5.18 Changes to Section 9.4 - MOMENT CONNECTIONS

“The required strength of beam-to-column moment connections shall be determined from the shear and flexure associated with the expected plastic flexural strength, $R_y M_n$, of the beams framing into the connection. The nominal connection strength shall meet the requirements in Section 7. In addition, the connections shall be capable of sustaining a minimum inelastic interstory drift angle of 0.025 radians and a total interstory drift angle of 0.04 radians. When the beam flanges are interrupted at the

connection, the inelastic rotation capacity shall be demonstrated as specified in Part I Section 9 for connections in SMF. For connections to reinforced concrete columns with a beam that is continuous through the column so that welded joints are not required in the flanges and the connection is not otherwise susceptible to premature fractures, the inelastic rotation capacity shall be demonstrated by testing or other substantiating data.”

10.5.19 Changes to Section 9.5 - COLUMN-BEAM MOMENT RATIO

“The minimum flexural strength of reinforced concrete columns shall meet the requirements in ACI 318 Section 21.4.2. The column-to-beam moment ratio of composite columns shall meet the requirements in Part I Section 9.6 with the following modifications:

1. The flexural strength of the composite column M_{pc}^* shall meet the requirements in LRFD Specification Chapter I with consideration of the applied axial load, P_u .
2. The force limit for the exceptions in Part I Section 9.6a shall be $P_u < 0.1P_o$.
3. Composite columns exempted by Part I Section 9.6 shall have transverse reinforcement that meets the requirements in Section 6.4c.3.”

10.5.20 Changes to Section 10.2 - COLUMNS

“Composite columns shall meet the requirements for intermediate seismic systems in Section 6.4 or 6.5. Reinforced concrete columns shall meet the requirements in ACI 318 Section 21.12.”

10.5.21 Changes to Section 10.4 - MOMENT CONNECTIONS

“10.4 Beam-to-Column Moment Connections

The nominal connection strength shall meet the requirements in Section 7. The required strength of beam-to-column connections shall meet the following requirements:

- a. The connection design strength shall meet or exceed the forces associated with plastic hinging of the beams adjacent to the connection.
- b. The connections shall demonstrate an interstory drift angle of at least 0.02 radians in cyclic tests.”

10.5.22 Changes to Section 11.4 - MOMENT CONNECTIONS

“Connections shall be designed for the applicable factored load combinations and their design strength shall meet the requirements in Section 7 and Section 11.2 of Part I.”

10.5.23 Changes to Section 12.4 - BRACES

“12. COMPOSITE SPECIAL CONCENTRICALLY BRACED FRAMES (C-SCBF)

12.4. Braces

Structural steel braces shall meet the requirements for SCBF in Part I Section 13. Composite braces shall meet the requirements for composite columns in Section 12.2.

13. COMPOSITE ORDINARY BRACED FRAMES (C-OBF)

13.1. Scope

This section is applicable to concentrically braced frame systems that consist of either composite or reinforced concrete columns, structural steel or composite beams, and structural steel or composite braces. C-OBF shall be designed assuming that under the Design Earthquake limited inelastic action will occur in the beams, columns, braces, and/or connections.”

10.5.24 Change title for Section 15.3 to “**15.3 Steel Coupling Beams.**”

10.5.25 Change title for Section 16.3 to “**16.3 Steel Coupling Beams.**”

10.5.26 Add new Section 15.4 as follows:

“15.4. Encased Composite Coupling Beams

Encased composite sections serving as Coupling Beams shall meet the requirements in Section 15.3 as modified in this Section:

- 15.4a. Coupling Beams shall have an embedment length into the reinforced concrete wall that is sufficient to develop the maximum possible combination of moment and shear capacities of the encased steel Coupling Beam.
- 15.4b. The nominal shear capacity of the encased steel Coupling Beam shall be used to meet the requirement in Section 15.3b.
- 15.4c. The stiffness of the encased steel Coupling Beams shall be used for calculating the shear wall and Coupling Beam design forces.”

10.5.27 Add new Section 16.4 as follows:

“16.4. Encased Composite Coupling Beams

Encased composite sections serving as Coupling Beams shall meet the requirements in Section 16.3, except the requirements in Part I Section 15.3 need not be met.

This page is intentionally left blank.

Chapter 11

MASONRY STRUCTURE DESIGN REQUIREMENTS

11.1 GENERAL

11.1.1 Scope. The design and construction of reinforced and plain masonry components and systems and the materials used therein shall comply with the requirements of this chapter. Masonry shall be designed in accordance with the requirements of ACI 530/ASCE 5/TMS 402. Masonry construction and materials shall be in accordance with the requirements of ACI 530.1/ASCE 6/TMS 602. Inspection and testing of masonry materials and construction shall be in accordance with the requirements of Chapter 2.

11.1.2 References. The following documents shall be used as specified in this chapter.

- ACI 530/ASCE 5/TMS 402 *Building Code Requirements for Masonry Structures* (ACI 530-02/ASCE 5-02/TMS 402-02), American Concrete Institute/American Society of Civil Engineers/The Masonry Society, 2002.
- ACI 530.1/ASCE 6/TMS 602 *Specification for Masonry Structures* (ACI 530.1-02/ASCE 6-02/TMS 602-02), American Concrete Institute/American Society of Civil Engineers/The Masonry Society, 2002.
- ACI 318 *Building Code Requirements for Structural Concrete*, American Concrete Institute, 2002, excluding Appendix A.

11.2 GENERAL DESIGN REQUIREMENTS

11.2.1 Classification of shear walls. Masonry walls, unless isolated from the lateral force resisting system, shall be considered shear walls and shall be classified in accordance with this section.

11.2.1.1 Ordinary plain (unreinforced) masonry shear walls. Ordinary plain (unreinforced) masonry shear walls shall satisfy the requirements of Section 1.13.2.2.1 of ACI 530/ASCE 5/TMS 402.

11.2.1.2 Detailed plain (unreinforced) masonry shear walls. Detailed plain (unreinforced) masonry shear walls shall satisfy the requirements of Section 1.13.2.2.2 of ACI 530/ASCE 5/TMS 402.

11.2.1.3 Ordinary reinforced masonry shear walls. Ordinary reinforced masonry shear walls shall satisfy the requirements of Section 1.13.2.2.3 of ACI 530/ASCE 5/TMS 402.

11.2.1.4 Intermediate reinforced masonry shear walls. Intermediate reinforced masonry shear walls shall satisfy the requirements of Section 1.13.2.2.4 of ACI 530/ASCE 5/TMS 402.

11.2.1.5 Special reinforced masonry shear walls. Special reinforced masonry shear walls shall satisfy the requirements of Section 1.13.2.2.5 of ACI 530/ASCE 5/TMS 402.

11.2.1.6 Shear keys. Add the following new Sec. 1.13.2.2.5 (d) to the Sec. 1.13.2.2.5 of ACI 530/ASCE 5/TMS 402. The surface of concrete upon which a special reinforced masonry shear wall is constructed shall have a minimum surface roughness of 1/8 in. (3 mm). Shear keys are required when the calculated tensile strain in vertical reinforcement from in-plane loads exceeds the yield strain under load combinations that include seismic forces based on an *R* factor equal to 1.5. Shear keys that satisfy the following requirements shall be placed at the interface between the wall and the foundation:

1. The width of the keys shall be at least equal to the width of the grout space,
2. The depth of the keys shall be at least 1.5 in. (38 mm),
3. The length of the key shall be at least 6 in. (152 mm),
4. The spacing between keys shall be at least equal to the length of the key,

5. The cumulative length of all keys at each end of the shear wall shall be at least 10 percent of the length of the shear wall (20 percent total),
6. At least 6 in. (150 mm) of a shear key shall be placed within 16 in. (406 mm) of each end of the wall, and
7. Each key and the grout space above each key in the first course of masonry shall be grouted solid.

11.2.2 Modifications to ACI 530/ASCE 5/TMS 402 and ACI 530.1/ASCE 6/TMS 602.

11.2.2.1 Additional definitions. Add the following definitions to Sec. 1.6 of ACI 530/ASCE 5/TMS 402:

“Actual dimension – The measured dimension of a designated item (e.g., a designated masonry unit or wall).

Cleanout – An opening to the bottom of a grout space of sufficient size and spacing to allow removal of debris.

Cover – Distance between surface of reinforcing bar and face of member.

Effective period – Fundamental period of the structure based on cracked stiffness.

Hollow masonry unit – A masonry unit whose net cross-sectional area in any plane parallel to the bearing surface is less than 75 percent of the gross cross-sectional area in the same plane.

Plastic hinge – The zone in a structural member in which the yield moment is anticipated to be exceeded under loading combinations that include earthquake. The zone in a masonry element in which earthquake energy is dissipated through the development of inelastic strains and curvatures.

Reinforced masonry – Masonry construction in which reinforcement acts in conjunction with the masonry to resist forces. Masonry in which the tensile resistance of masonry is neglected and the resistance of the reinforcing steel is considered in resisting applied loads.

Solid masonry unit – A masonry unit whose net cross-sectional area in any plane parallel to the bearing surface is 75 percent or more of the gross cross-sectional area in the same plane.

Special moment frame – A moment resisting frame of masonry beams and masonry columns within a plane with special reinforcement details and connections that provides resistance to lateral and gravity loads.

Specified – Required by construction documents.

Stirrup – Shear reinforcement in a beam or flexural member.”

11.2.2.2 Additional notation. Add the following notation to Sec. 1.5 of ACI 530/ASCE 5/TMS 402:

“ d_{bb} = diameter of the largest beam longitudinal reinforcing bar passing through, or anchored in, the special moment frame beam-*column* intersection.

d_{bp} = diameter of the largest *column* (pier) longitudinal reinforcing bar passing through, or anchored in, the special moment frame beam-*column* intersection.

h_x = height of structure above the base level to level x .

h_b = beam depth in the plane of the special moment frame.

h_c = cross-sectional dimension of grouted core of special moment frame member measured center to center of confining reinforcement.

L_c = length of coupling beam between coupled *shear walls*.

M_1, M_2 = nominal moment strength at the ends of the coupling beam.

V_g = unfactored shear force due to gravity loads.”

11.2.2.3. Delete Article 1.3 AE from ACI 530.1/ASCE 6/TMS 602.

11.2.2.4. Add the following exception after the second paragraph of Sec. 3.2.5.5 of ACI 530/ASCE 5/TMS 402.

“Exception: A nominal thickness of 4 in. (102 mm) shall be permitted where load-bearing reinforced hollow clay unit masonry walls satisfy all of the following conditions.

1. The maximum unsupported height-to-thickness or length-to-thickness ratios do not exceed 27,
2. The net area unit strength exceeds 8,000 psi (55 MPa),
3. Units are laid in running bond,
4. Bar sizes do not exceed No. 4 (13 mm),
5. There are no more than two bars or one splice in a cell, and
6. Joints are not raked.”

11.2.2.5. Add the following new Sec. 1.15.3 to ACI 530/ASCE 5/TMS 402:

“1.15.3 Separation joints. Where concrete abuts structural masonry and the joint between the materials is not designed as a separation joint, the concrete shall be roughened so that the average height of aggregate exposure is 1/8 in. (3 mm) and shall be bonded to the masonry in accordance with these requirements as if it were masonry. Vertical joints not intended to act as separation joints shall be crossed by horizontal reinforcement as required by Sec. 1.9.4.2.”

11.2.2.6. Add the following new Article 3.5 G to ACI 530.1/ASCE 6/TMS 602:

“3.5 G. Construction procedures or admixtures shall be used to facilitate placement and control shrinkage of grout.”

11.2.2.7. Replace Sec. 3.2.3.4(b) and 3.2.3.4(c) of ACI 530.1/ASCE 6/TMS 602 with the following:

“(b) A welded splice shall be capable of developing in tension 125 percent of the specified yield strength, f_y , of the bar. Welded splices shall only be permitted for ASTM A706 steel reinforcement. Welded splices shall not be permitted in plastic hinge zones of intermediate or special reinforced walls or special moment frames of masonry.

(c) Mechanical splices shall be classified as Type 1 or Type 2 according to Sec. 21.2.6.1 of ACI 318. Type 1 mechanical splices shall not be used within a plastic hinge zone or within a beam-column joint of intermediate or special reinforced masonry shear walls or special moment frames. Type 2 mechanical splices shall be permitted in any location within a member.”

11.2.2.8. Add the following new Sec. 3.2.3.4.1 and 3.2.3.4.2 to ACI 530/ASCE 5/TMS 402:

“3.2.3.4.1 Lap splices shall not be used in plastic hinge zones. The length of the plastic hinge zone shall be taken as at least 0.15 times the distance between the point of zero moment and the point of maximum moment.

3.2.3.4.2 Bars spliced by non-contact lap splices shall not be spaced transversely farther apart than the lesser of one-fifth the required length or 8 in. (203 mm).”

11.2.2.9. Add the following new Sec. 3.2.2(h) to ACI 530/ASCE 5/TMS 402:

“(h) For out-of-plane bending, the width of the equivalent stress block shall not be taken greater than 6 times the nominal thickness of the masonry wall or the spacing between reinforcement, whichever is less.”

11.2.2.10. Add the following new Sec. 3.2.7 to ACI 530/ASCE 5/TMS 402:

“3.2.7 Flanged shear walls

3.2.7.1 Effective width. Where wall intersections are constructed in accordance with Sec. 1.9.4, the effective flange width for design shall be determined in accordance with this section.

3.2.7.2 Compression. The width of flange considered effective in compression on each side of the web shall be taken equal to 6 times the thickness of the flange or the actual width of the flange on that side, whichever is less.

3.2.7.3 Tension. The width of flange considered effective in tension on each side of the web shall be taken equal to 3/4 of the wall height or the actual width of the flange on that side, whichever is less.”

11.2.2.11. Add the following new Sec. 3.2.4.2.6 to ACI 530/ASCE 5/TMS 402:

“3.2.4.2.6 Coupling beams. Structural members that provide coupling between shear walls shall be designed to reach their moment or shear nominal strength before either shear wall reaches its moment or shear nominal strength. Analysis of coupled shear walls shall comply with accepted principles of mechanics.

The design shear strength, ϕV_n , of the coupling beams shall satisfy the following criterion:

$$\phi V_n \geq \frac{1.25(M_1 + M_2)}{L_c} + 1.4V_g$$

where:

M_1 and M_2	=	nominal moment strength at the ends of the beam;
L_c	=	length of the beam between the shear walls; and
V_g	=	unfactored shear force due to gravity loads.

The calculation of the nominal flexural moment shall include the reinforcement in reinforced concrete roof and floor systems. The width of the reinforced concrete used for calculations of reinforcement shall be six times the floor or roof slab thickness.”

11.2.2.12. Add the following new Sec. 3.2.5 to ACI 530/ASCE 5/TMS 402:

“3.2.5 Deep flexural member detailing. Flexural members with overall-depth-to-clear-span ratio greater than 2/5 for continuous spans or 4/5 for simple spans shall be detailed in accordance with this section.

3.2.5.1. Minimum flexural tension reinforcement shall conform to Sec. 3.2.4.3.2.

3.2.5.2. Uniformly distributed horizontal and vertical reinforcement shall be provided throughout the length and depth of deep flexural members such that the reinforcement ratios in both directions are at least 0.001. Distributed flexural reinforcement is to be included in the determination of the actual reinforcement ratios.”

11.2.2.13. Add the following new Sec. 1.13.7.4 to ACI 530/ASCE 5/TMS 402:

“1.13.7.4 For structures in Seismic Design Category E or F, corrugated sheet metal anchors shall not be used.”

11.2.2.14. Revise Sec. 1.13.3.2 of ACI 530/ASCE 5/TMS 402/ to read as follows.

“ The calculated story drift of masonry structures due to the combination of design seismic forces and gravity loads shall not exceed the allowable story drift Δ_a for masonry walls shown in Table 4.5-1 of the 2003 *NEHRP Recommended Provisions*.

11.2.2.15. Add the following section to ACI 530/ASCE 5/TMS 402:

“1.13.4.3 Anchoring to masonry. Anchorage assemblies connecting masonry elements that are part of the seismic force resisting system to diaphragms and chords shall be designed so that the strength of the

anchor is governed by steel tensile or shear yielding. Alternatively, the anchorage assembly may be designed to be governed by masonry breakout or anchor pullout provided that the anchorage assembly is designed to resist not less than 2.5 times the factored forces transmitted by the assembly. “

11.2.2.16. Revise the following Sec. 3.1.4.4 of ACI 530/ASCE 5/TMS 402:

“**3.1.4.4 Anchor bolts** For cases where the nominal strength of an anchor bolt is controlled by masonry breakout or masonry pryout, ϕ shall be taken as 0.50. For cases where the nominal strength of an anchor bolt is controlled by anchor bolt steel, ϕ shall be taken as 0.90. For cases where the nominal strength of an anchor bolt is controlled by anchor pullout, ϕ shall be taken as 0.65.”

11.2.2.17. Revise the following Sec. 3.1.6.3 of ACI 530/ASCE 5/TMS 402:

“**3.1.6.3 Nominal shear strength of headed and bent-bar anchor bolts** — The nominal shear strength, B_{vn} , shall be computed by Eq. (3-8) (strength governed by masonry breakout) and Eq. (3-9) (strength governed by steel), and shall not exceed 2.0 times that computed by Eq. (3-4) (strength governed by masonry pryout). In computing the capacity, the smallest of the design strengths shall be used.”

11.2.2.18. Revise the following commentary to Sec. 3.1.6.3 of ACI 530/ASCE 5/TMS 402:

“**3.1.6.3 Nominal shear strength of headed and bent-bar anchor bolts** — The shear strength of a headed or bent-bar anchor bolt is governed by yield and fracture of the anchor steel, ~~or~~ by masonry shear breakout, or by masonry shear pryout. Steel strength is calculated conventionally using the effective tensile stress area (that is, threads are conservatively assumed to lie in the critical shear plane). Under static shear loading, bent-bar anchor bolts (J- or L-bolts) do not exhibit straightening and pullout. Under reversed cyclic shear however, available research^{3.1} suggests that straightening and pullout may occur.”

11.3 SPECIAL MOMENT FRAMES OF MASONRY

Special moment frames of masonry shall be designed and detailed in accordance with the requirements of Sec. 3.2 of ACI 530/ASCE 5/TMS 402 and this section.

Special moment frames shall be fully grouted and constructed using open-end hollow -unit concrete masonry or hollow-unit clay masonry.

Column nominal moment strength shall not be less than 1.6 times the column moment corresponding to the development of beam plastic hinges, except at the foundation level. The column axial load corresponding to the development of beam plastic hinges and including factored dead and live loads shall not exceed $0.15 A_n f'_m$. The plastic hinge zone shall be assumed equal to the depth of the member.

11.3.1 Calculation of required strength. The calculation of required strength of the members shall be in accordance with principles of engineering mechanics and shall consider the effects of the relative stiffness degradation of the beams and columns.

11.3.2 Flexural yielding. Flexural yielding shall be limited to the beams at the face of the columns and to the bottom of the columns at the base of the structure.

11.3.3 Materials. Neither Type N mortar nor masonry cement shall be used.

11.3.4 Reinforcement

11.3.4.1. The nominal moment strength at any section along a member shall not be less than 1/2 of the higher moment strength provided at the two ends of the member.

11.3.4.2. Lap splices are permitted only within the center half of the member length. Lap splices are not permitted in transverse reinforcement in beams, in plastic hinge zones in the column or in the beam-column joint.

11.3.4.3. Welded splices and mechanical connections may be used for splicing the reinforcement at any section, provided that not more than alternate longitudinal bars are spliced at a section and the distance between splices on alternate bars is at least 24 in. (610 mm) along the longitudinal axis and shall comply with the requirements of Section 11.3.7.4.

11.3.4.4. Reinforcement shall have a specified yield strength of 60,000 psi (414 MPa). The actual yield strength shall not exceed 1.3 times the specified yield strength.

11.3.5 Beams

11.3.5.1 Compression limit. The factored axial compression force on the beam shall not exceed 0.10 times the net cross-sectional area of the beam, A_n , times the specified compressive strength, f'_m .

11.3.5.2 Shear. The value of V_m shall be zero within any plastic hinge zone and in any columns subjected to net factored tension loads. The depth of the plastic hinge zone shall be assumed equal to the member depth..

11.3.5.3 Reinforcement ratio. The reinforcement ratio for beams that connect vertical elements of the seismic-force-resisting system shall not exceed the lesser of $0.15 \frac{f'_m}{f_y}$ or that determined in accordance with Sec. 3.2.3.5.1 of ACI 530/ASCE 5/TMS 402. All reinforcement in the beam and adjacent to the beam in a reinforced concrete roof or floor system shall be used to calculate the reinforcement ratio.

11.3.5.4 Proportions. The clear span for the beam shall not be less than 4 times its depth.

The nominal depth of the beam shall not be less than 4 units or 32 in. (813 mm), whichever is greater. The nominal depth to nominal width ratio shall not exceed 4.

Nominal width of the beams shall equal or exceed all of the following criteria:

1. 8 in. (203 mm),
2. width required by Sec. 3.2.4.2.5 of ACI 530/ASCE 5/TMS 402, and
3. 1/26 of the clear span between column faces.

11.3.5.5 Longitudinal reinforcement.

11.3.5.5.1. Longitudinal reinforcement shall not be spaced more than 8 in. (203 mm) on center.

11.3.5.5.2. Longitudinal reinforcement shall be uniformly distributed along the depth of the beam.

11.3.5.5.3. The minimum reinforcement ratio shall be $130/f_y$, where f_y is in psi (the metric equivalent is $0.90/f_y$, where f_y is in MPa).

11.3.5.5.4. At any section of a beam, each masonry unit through the beam depth shall contain longitudinal reinforcement.

11.3.5.6 Transverse reinforcement

11.3.5.6.1. Transverse reinforcement shall be one-piece and shall be hooked around top and bottom longitudinal bars and shall be terminated with a standard 180-degree hook.

11.3.5.6.2. Within an end region extending one beam depth from Special Moment Frame column faces and in any region at which beam plastic hinges may form during seismic or wind loading, the maximum spacing of transverse reinforcement shall not exceed one-fourth the nominal depth of the beam.

11.3.5.6.3. The maximum spacing of transverse reinforcement shall not exceed the lesser of 1/2 the nominal depth of the beam or the spacing required for shear strength.

11.3.5.6.4. The minimum transverse reinforcement ratio shall be 0.0015.

11.3.5.6.5. The first transverse bar shall not be more than 4 in. (102 mm) from the face of the column.

11.3.6 Columns

11.3.6.1 Compression limit. Factored axial compression force on the Special Moment Frame column corresponding to the development of beam plastic hinges shall not exceed 0.15 times the net cross-sectional area of the column, A_n , times the specified compressive strength. The compressive stress shall also be limited by the maximum reinforcement ratio.

11.3.6.2 Proportions. The nominal dimension of the column parallel to the plane of the Special Moment Frame shall not be less than two full units or 32 in. (810 mm), whichever is greater and shall not exceed 96 in.

The nominal dimension of the column perpendicular to the plane of the Special Moment Frame shall not be less than 8 in. (203 mm) or 1/14 of the clear height between beam faces, whichever is greater.

The clear-height-to-depth ratio of column members shall not exceed 5.

11.3.6.3 Longitudinal reinforcement

11.3.6.3.1. A minimum of 4 longitudinal bars shall be provided at all sections of every Special Moment Frame column member.

11.3.6.3.2. The flexural reinforcement shall be uniformly distributed across the member depth.

11.3.6.3.3. The nominal moment strength at any section along a member shall be not less than 1.6 times the cracking moment strength and the minimum reinforcement ratio shall be $130/f_y$, where f_y is in psi (the metric equivalent is $0.90/f_y$, where f_y is in MPa).

11.3.6.3.4. Vertical reinforcement in wall-frame columns shall be limited to a maximum reinforcement ratio equal to the lesser of $0.15 \frac{f'_m}{f_y}$ or that determined in accordance with Sec. 3.2.3.5 of Section 1.13.2.2.5 of ACI 530/ASCE 5/TMS 402. The minimum vertical reinforcement in wall-frame columns shall be 0.002 times the gross cross section.

11.3.6.4 Lateral reinforcement.

11.3.6.4.1. Transverse reinforcement shall be hooked around the extreme longitudinal bars and shall be terminated with a standard 180-degree hook.

11.3.6.4.2. The spacing of transverse reinforcement shall not exceed 1/4 the nominal dimension of the column parallel to the plane of the Special Moment Frame.

11.3.6.4.3. The minimum transverse reinforcement ratio shall be 0.0015.

11.3.6.4.4. Lateral reinforcement shall be provided to confine the grouted core when compressive strains caused by the factored axial and flexural loads at the design story drift, δ , exceed 0.0015. The unconfined portion of the cross section with a strain exceeding 0.0015 shall be neglected when computing the nominal strength of the section. The total cross sectional area of rectangular tie reinforcement for the confined core shall be not less than $0.9sh_c \frac{f'_m}{f_{yh}}$. Alternatively, equivalent

confinement which can develop an ultimate compressive strain of 0.006 may substituted for rectangular tie reinforcement.

11.3.7 Beam-column intersections

11.3.7.1 Proportions. Beam-column intersection dimensions in masonry special moment frames shall be proportioned such that the special moment frame column depth in the plane of the frame satisfies Eq. 11.3-1:

$$h_c > \frac{4800d_{bb}}{\sqrt{f'_g}} \quad (11.3-1)$$

where:

- h_p = column depth in the plane of the special moment frame, in.;
- d_{bb} = diameter of the largest beam longitudinal reinforcing bar passing through, or anchored in, the special moment frame beam-column intersection, in.; and
- f'_g = specified compressive strength of grout, psi (shall not exceed 5,000 psi (34.5MPa) for use in Eq. 11.3-1).

The metric equivalent of Eq. 11.3-1 is

$$h_c > \frac{400d_{bb}}{\sqrt{f'_g}}$$

where h_p and d_{bb} are in mm and f'_g is in MPa.

Beam depth in the plane of the frame shall satisfy Eq. 11.3-2:

$$h_b > \frac{1800d_{bp}}{\sqrt{f'_g}} \quad (11.3-2)$$

where:

- h_b = beam depth in the plane of the special moment frame, in.;
- d_{bp} = diameter of the largest column longitudinal reinforcing bar passing through, or anchored in, the special moment frame beam-column intersection, in.; and
- f'_g = specified compressive strength of grout, psi (shall not exceed 5,000 psi (34.5 MPa) for use in Eq. 11.3-2).

The metric equivalent of Eq. 11.3-2 is

$$h_b > \frac{150d_{bp}}{\sqrt{f'_g}}$$

where h_b and d_{bp} are in mm and f'_g is in MPa.

11.3.7.2 Shear strength. The design shear strength, NV_n , of the beams and columns shall not be less than the shear corresponding to the development of 1.4 times the nominal flexural strength of the member, except that the nominal shear strength need not exceed 2.5 times V_u . The nominal shear strength of beam-column intersections shall exceed the shear calculated assuming that the stress in all flexural tension reinforcement of the special moment frame beams at the column face is $1.4f_y$.

Vertical shear forces may be considered to be carried by a combination of masonry shear-resisting mechanisms and truss mechanisms involving intermediate column reinforcing bars.

The nominal horizontal shear stress at the beam-column intersection shall not exceed the lesser of 350 psi (2.5 MPa) or $7\sqrt{f'_m}$ (the metric equivalent is $0.58\sqrt{f'_m}$ MPa)

11.3.7.3 Horizontal reinforcement. Beam longitudinal reinforcement terminating in a special moment frame column shall be extended to the far face of the column and shall be anchored by a standard hook bent back into the special moment frame column.

Special horizontal shear reinforcement crossing a potential diagonal beam-column shear crack shall be provided such that:

$$A_s \geq \frac{0.5V_{jh}}{f_y} \quad (11.3-3)$$

where:

- A_s = cross-sectional area of reinforcement;
- V_{jh} = total horizontal joint shear; and
- f_y = specified yield strength of the reinforcement .

Special horizontal shear reinforcement shall be anchored by a standard hook around the extreme special moment frame column reinforcing bars.

11.4 GLASS-UNIT MASONRY AND MASONRY VENEER

11.4.1 Design lateral forces and displacements. Glass-unit masonry and masonry veneer shall be designed and detailed to satisfy the force and displacement requirements of Sec. 6.3.

11.4.2 Glass-unit masonry design.

11.4.2.1. The requirements of Chapter 7 of ACI 530/ASCE 5/TMS 402. shall apply to the design of glass unit masonry. The out-of-plane seismic strength shall be considered to be the same as the strength to resist wind pressure as specified in Sec. 7.3 of ACI 530/ASCE 5/TMS 402.

11.4.3 Masonry veneer design.

11.4.3.1. The requirements of Chapter 6 of ACI 530 shall apply to the design of masonry veneer.

11.4.3.2. For structures in Seismic Design Category E, corrugated sheet metal anchors shall not be used.

11.5 PRESTRESSED MASONRY

11.5.1. Prestressed masonry shall be designed in accordance with of ACI 530/ASCE 5/TMS 402 Chapter 4.

This page is intentionally left blank

Chapter 12

WOOD STRUCTURE DESIGN REQUIREMENTS

12.1 GENERAL

12.1.1 Scope. The design and construction of wood structures to resist seismic forces and the material used therein shall comply with the requirements of this chapter.

12.1.2 References. Documents containing requirements for the quality, testing, design, and construction of members and their fastenings in wood systems that resist seismic forces are listed in this section. The provisions of this chapter may add to, modify or exempt portions of the referenced documents.

12.1.2.1 Engineered wood construction

AF&PA/ASCE 16	<i>Standard for Load and Resistance Factor Design for Engineered Wood Construction</i> , American Forest & Paper Association/American Society of Civil Engineers, 1995, including supplements.
AF&PA SDPWS	ASD/LRFD Supplement, <i>Special Design Provisions for Wind and Seismic</i> , American Forest & Paper Association, 2001.
APA Y510T	<i>Plywood Design Specifications</i> , American Plywood Association, 1998.
APA N375B	<i>Design Capacities of APA Performance-Rated Structural-Use Panels</i> , American Plywood Association, 1995.
APA E315H	<i>Diaphragms</i> (APA Research Report 138), American Plywood Association, 1991.

12.1.2.2 Conventional light-frame construction

IRC	<i>International Residential Code</i> , International Code Council (ICC), 2003.
NF&PA T903	<i>Span Tables for Joists and Rafters</i> , National Forest and Paper Association, 1992.

12.1.2.3 Material standards

PS 20	<i>American Softwood Lumber Standard</i> , U.S. Department of Commerce, National Institute of Standards and Technology, 1999.
AITC A190.1	<i>American National Standard for Wood Products Structural Glued Laminated Timber</i> , American National Standards Institute/American Institute of Timber Construction, 1992.
ASTM A 653	<i>Specification for Steel Sheet, Zinc-Coated (Galvanized) or Zinc-Iron Alloy-Coated (Galvannealed) by the Hot-dip Process (A 653-97a)</i> , American Society for Testing and Materials, 1997.
ASTM A 792	<i>Specification for Steel Sheet, 55% Aluminum-Zinc Alloy-Coated by the Hot-dip Process (A 792-97a)</i> , American Society for Testing and Materials, 1997.
ASTM A 875	<i>Specification for Steel Sheet, Zinc-5% Aluminum Alloy-Coated by the Hot-dip Process (A 875-97a)</i> , American Society for Testing and Materials, 1997.

ASTM D 5055

Standard Specification for Establishing and Monitoring Structural Capacities of Prefabricated Wood I-Joists (D 5055-97^{e1}), American Society of Testing and Materials, 1997.

PS 1	<i>Construction and Industrial Plywood</i> , U.S. Department of Commerce, National Institute of Standards and Technology, 1995.
PS 2	<i>Performance Standard for Wood-Based Structural-Use Panels</i> , U.S. Department of Commerce, National Institute of Standards and Technology, 1992.
ANSI 05.1	<i>Wood Poles</i> , American National Standards Institute, 1992.
ANSI A208.1	<i>Wood Particleboard</i> , American National Standards Institute, 1992.
AWPA C1, 2, 3, 9, 28	<i>Preservative Treatment by Pressure Process</i> , American Wood Preservers Association, AWPA C1, C2, C3, and C28, 1991; C9, 1990.

12.1.3 Definitions

Bearing wall: See Sec. 4.1.3.

Blocked diaphragm: A diaphragm in which all sheathing edges not occurring on a framing member are supported on and fastened to blocking.

Boundary elements: See Sec. 2.1.3.

Braced wall line: A series of braced wall panels in a single story that satisfies the requirements of Sec. 12.4.1.

Braced wall panel: A section of wall braced in accordance with Sec. 12.4.1.

Cripple wall: A framed stud wall, less than 8 ft (2.4 m) tall, extending from the top of the foundation to the underside of the lowest floor framing. Cripple walls can occur in both engineered structures and conventional construction.

Diaphragm: See Sec. 4.1.3.

Drag strut: See Sec. 4.1.3.

Grade plane: See Sec. 6.1.3.

Light-framed shear wall: A wall constructed with wood or cold-formed steel studs and sheathed with material approved for shear resistance.

Light-framed wall: A wall with wood or steel studs.

Perforated shear wall: A wood structural panel sheathed wall with openings, but which has not been specifically designed and detailed for force transfer around wall openings.

Perforated shear wall segment: A section of shear wall with full height sheathing and which satisfies the aspect ratio limits of Sec.4.3.4.1 of the AF&PA SDPWS.

Seismic Design Category: See Sec. 1.1.4.

Seismic-force-resisting system: See Sec. 1.1.4.

Seismic Use Group: See Sec. 1.1.4.

Shear wall: See Sec. 4.1.3.

Story above grade: See Figure 12.4-1.

Structure: See Sec. 1.1.4.

Tie-down: A device used to resist uplift of the chords of shear walls. These devices are intended to resist load without significant slip between the device and the shear wall chord or be shown with cyclic testing to not reduce the wall capacity and ductility.

Wall: See Sec. 4.1.3.

Wood structural panel: A wood-based panel product that satisfies the requirements of PS 1 or PS 2 and is bonded with a waterproof adhesive. Included under this designation are plywood, oriented strand board, and composite panels.

12.1.4 Notation

A	Total area of openings in the perforated shear wall calculated such that opening height is assigned wall height, h , where structural sheathing is not present above or below openings and openings with height less than $h/3$ are assigned a height of $h/3$;
h	Height of the perforated shear wall.
L_{tot}	Total length of a perforated shear wall including the lengths of perforated shear wall segments and the lengths of segments containing openings;
r	Sheathing area ratio. Perforated shear walls shall have a minimum sheathing area ratio of 0.1.
V_{wall}	Nominal shear capacity of a perforated shear wall.
v_{wall}	Nominal unit shear capacity for wood structural panel from Table 4.3A.
ΣL_i	Sum of lengths of perforated shear wall segments.

12.2 DESIGN METHODS

Structures constructed in accordance with Sec. 12.5 are deemed to satisfy Sec. 1.5. Where a structure of otherwise conventional construction contains structural elements that do not comply with the requirements of Sec. 12.5, such elements shall be designed in accordance with Sec. 12.3 and 12.4.

12.2.1 Seismic Design Categories B, C, and D. Unless excepted by Sec. 1.1.2.1, structures assigned to Seismic Design Category B, C, or D shall satisfy the requirements for engineered wood construction in accordance with LRFD provisions of *AF&PA SDPWS* as modified by Sec. 12.2.3 or shall satisfy the requirements for conventional light-frame construction in accordance with Sec. 12.5.

12.2.2 Seismic Design Categories E and F. Unless excepted by Sec. 1.1.2.1, structures assigned to Seismic Design Category E or F shall satisfy the requirements for engineered wood construction in accordance with LRFD provisions of *AF&PA SDPWS* as modified by Sec. 12.2.4.

12.2.3 Modifications to AF&PA SDPWS for Seismic Design Categories B, C and D

12.2.3.1 Revise second sentence of Sec. 4.1.2 of *AF&PA SDPWS* as follows:

“Alternatively, shear capacity of diaphragms and shear walls shall be permitted to be calculated by principles of mechanics using values of fastener strength and sheathing shear capacity provided consideration is given to the combined fastener and sheathing performance under cyclic loading.”

12.2.3.2 Replace last paragraph of Sec. 4.2.2 of *AF&PA SDPWS* with the following:

“The mid-span deflection of a single span blocked wood structural panel diaphragm uniformly loaded and uniformly nailed throughout shall be calculated using a rational analysis accounting for bending deformation, panel shear deformation, non-linear slip in the sheathing to framing connections, and boundary member connections. Adjustments shall be made for other span, blocking, loading and nailing configurations.”

12.2.3.3 In Table 4.2.4 of *AF&PA SDPWS*, modify aspect ratio for “Double-layer diagonal lumber sheathing” from 4:1 to 3:1.

12.2.3.4 Add sentence to 4.2.7.1(1) of *AF&PA SDPWS* as follows:

“Sheathing shall be arranged so that the width shall not be less than 2 ft (0.6 m).”

12.2.3.5 Add Sec. 4.2.7.1(5) to AF&PA SDPWS as follows:

“4.2.7.1(5) It is advised that the edge distance be increased where possible to reduce the potential for splitting of the framing and nail pull through in the sheathing.”

12.2.3.6 Delete 4.2.7.4 and related design values from Tables 4.2C from AF&PA SDPWS.**12.2.3.7** Replace last paragraph of Sec. 4.3.2 of AF&PA SDPWS with the following:

“The deflection of a wood structural panel shear wall shall be calculated using a rational analysis accounting for bending deformation, panel shear deformation, non-linear slip in the sheathing to framing connections and boundary member connections.”

12.2.3.8 Replace first 3 paragraphs of Sec. 4.3.3.2 of AF&PA SDPWS (keep wind exception) with the following:

“The shear values for wood structural panel sheathing of different capacities applied to the same side of the wall are not cumulative except as allowed in Table 12.2-3a and 12.2-3b. The shear values for structural panel sheathing of the same capacity applied to both faces of the same wall are cumulative. Where the structural panel sheathing capacities are not equal, the allowable shear shall be either two times the smaller shear capacity or the capacity of the stronger side, whichever is greater. Shear capacities shall not be summed where dissimilar materials are applied to opposite faces or to the same wall line.”

12.2.3.9 Add paragraph to Sec. 4.3.3.4 of AF&PA SDPWS as follows:

“The nominal shear capacity of a perforated shear wall is permitted to be calculated in accordance with the following:

$$V_{wall} = \frac{r}{3-2r} L_{tot} v_{wall}$$

$$r = \frac{1}{1 + \frac{A}{h \sum L_i}}$$

where:

V_{wall} = nominal shear capacity of a perforated shear wall;

r = sheathing area ratio. Perforated shear walls shall have a minimum sheathing area ratio of 0.1;

L_{tot} = total length of a perforated shear wall including the lengths of perforated shear wall segments and the lengths of segments containing openings;

v_{wall} = nominal unit shear capacity for wood structural panel from Table 4.3A;

A = total area of openings in the perforated shear wall calculated such that opening height is assigned wall height, h , where structural sheathing is not present above or below openings and openings with height less than $h/3$ are assigned a height of $h/3$;

h = height of the perforated shear wall; and,

$\sum L_i$ = sum of lengths of perforated shear wall segments.”

12.2.3.10 Replace Sec. 4.3.5.2b of AF&PA SDPWS with the following:

“b. The nominal shear value for wood structural panels used in a perforated shear wall shall not exceed 980 lb/ft (14.5 kN/m).”

12.2.3.11 Replace paragraph 1 of 4.3.6.4b of AF&PA SDPWS with the following:

“b. Where net uplift is induced, tie-down devices shall be used. Nuts on tie-down bolts shall be tightened without crushing the wood prior to covering the framing. Tie-down devices shall be attached to the end posts with nails, screws, or other fasteners. All tie-down devices shall only be

used where the uplift resistance values are based on cyclic testing of wall assemblies and the test results indicate that the tie-down device does not reduce the stiffness, ductility, or capacity of the shear wall where compared to nailed-on devices. Nominal strength of the tie-down assemblies shall be equal to or greater than the forces resulting from the nominal strength of the wall. The stiffness of the tie-down assemblies shall be such as to prevent premature failure of the sheathing fasteners, and the effect of the tie-down displacement shall be included in drift calculations. End posts shall be selected such that failure across the net section of the post is not a limit state for the connection of the tie-down.”

12.2.3.12 Replace 4.3.6.4c of AF&PA SDPWS with the following:

“c. Shear wall bottom plate connections to floor framing or foundations shall have a nominal strength equal to or greater than the nominal strength of the shear wall.

Foundation anchor bolts shall have a plate washer under the nut. The minimum plate washer sizes shall be determined in accordance with the following (Table 12.2-1):

Table 12.2.1 Minimum Plate Washers for Foundation Anchor Bolts

Anchor bolt size	Plate washer size
1/2 and 5/8 in. (13 and 16 mm)	1/4 by 3 by 3 in. (6 by 75 by 75 mm)
3/4, 7/8, and 1 in. (19, 22, and 25 mm)	3/8 by 3 by 3 in. (10 by 75 by 75 mm)

The hole in a plate washer is permitted to be diagonally slotted with a width of up to 3/16 inches (5mm) larger than the bolt diameter and a slot length not to exceed 1.75 inches (44mm), if a standard cut washer is placed between the plate washer and the nut.

Foundation anchor bolts shall be placed a maximum of 2 in. (50 mm) from the sheathed side of walls sheathed on one face. Walls sheathed on both faces shall have the bolts staggered with each bolt a maximum of 2 in. (50 mm) from either side of the wall. Alternatively, for walls sheathed on both faces, the bolts shall be placed at the center of the foundation sill with the edge of the plate washer within 0.5 in. (13 mm) of each face of the wall. Where this alternative is used, the plate washer width shall be a minimum of 3 in. (75 mm) and the plate thickness shall be determined by analysis using the upward force on the plate equal to the tension capacity of the bolt.

Nuts on foundation anchor bolts shall be tightened without crushing the wood prior to covering the framing.”

12.2.3.13 Replace second sentence of 4.3.7.1a of AF&PA SDPWS as follows:

“Sheathing panels not less than 4ft x 8ft. Sheathing shall be arranged so that the width shall not be less than 2 ft (0.6 m).

Exception: For sheathing attached with the long direction of the panels perpendicular to the studs, a single sheathing panel with a minimum vertical dimension of 1 ft (0.3 m) and a minimum horizontal dimension of 4 ft (1.2 m) is permitted to be used if it is located at mid-height of the wall, and is fully blocked and fastened.”

12.2.3.14 Add Sec. 4.3.7.1f and 4.3.7.1g to AF&PA SDPWS as follows:

“f. It is advised that the edge distance be increased where possible to reduce the potential for splitting of the framing and nail pull through in the sheathing. Sheathing fasteners shall be driven flush with the surface of the sheathing.

g. Where wood structural panel sheathing is used as the exposed finish on the exterior of outside

walls, it shall have an exterior exposure durability classification. Where wood structural panel sheathing is used on the exterior of outside walls but not as the exposed finish, it shall be of a type manufactured with exterior glue. Where wood structural panel sheathing is used elsewhere, it shall be of a type manufactured with intermediate or exterior glue.”

12.2.3.15 Delete 4.3.7.2, 4.3.7.3, 4.3.7.4, 4.3.7.7 and 4.3.7.8 and related design values from Tables 4.3A, 4.3B, and 4.3C from AF&PA SDPWS.

12.2.3.16 Add Table 12.2-2a and 12.2-2b as addendum to Table 4.2A.

12.2.3.17 Add Table 12.2-3a and 12.2-3b as addendum to Table 4.3A.

12.2.4 Modifications to AF&PA SDPWS for Seismic Design Categories E and F

Structures assigned to Seismic Design Categories E and F shall conform to the requirements of Sec. 12.2.3 for Seismic Design Categories B, C and D, and the requirements of this section.

12.2.4.1 Add second sentence to Sec. 4.2.7.1 of AF&PA SDPWS as follows:

“Unblocked diaphragms sheathed with wood structural panels shall not be considered to be part of the seismic-force-resisting system for structures assigned to Seismic Design Category E or F.”

12.2.4.2 Add second sentence to Sec. 4.3.3.1 of AF&PA SDPWS as follows:

“For structures assigned to Seismic Design Category E or F, tabulated nominal unit shear capacities for wood structural panel sheathed shear walls used to resist seismic forces in structures with concrete or masonry walls shall be one-half the values set forth in Table 4.3A.”

12.2.4.3 Add second sentence to Sec. 4.3.7.1 of AF&PA SDPWS as follows:

“Wood structural panel sheathing used for shear walls that are part of the seismic-force-resisting system shall be applied directly to the framing members for structures assigned to Seismic Design Category E or F.”

Table 12.2-2a Nominal Unit Shear Values (lb/ft) for Seismic Forces on Horizontal Wood Diaphragms

Panel Grade	Fastener		Minimum nominal panel thickness (in.)	Minimum nominal width of framing (in.)	Lines of fasteners	Blocked Diaphragms ^{a,b}					
	Type	Minimum penetration in framing (in.)				Fastener spacing (in.) at diaphragm boundaries (all Cases), at continuous panel edges parallel to load (Cases 3 and 4) and at all panel edges (Cases 5 and 6) ^{c,d}					
						4		2-1/2		2	
						Spacing per line at other panel edges (in.)					
6	4	4	3	3	2						
Structural I	10d ^e common	1-1/2	23/32	3	2	1310	1740	1880	2460	—	—
				4	2	1510	1950	2150	2820	—	—
				4	3	1880	2620	2750	3620	—	—
	14 ga staples	2	23/32	3	2	1200	1200	1680	1800	2080	2400
				4	3	1680	1800	2280	2710	2880	3600
Sheathing, single floor and other grades covered in PS 1 and PS 2	10d ^e common	1-1/2	23/32	3	2	1290	1740	1880	2450	—	—
				4	2	1510	1950	2150	2780	—	—
				4	3	1880	2620	2740	3020	—	—
	14 ga staples	2	23/32	3	2	1200	1200	1650	1800	2050	2400
				4	3	1650	1800	2250	2710	2800	3020

^a Nominal unit shear values shall be adjusted in accordance with AF&PA SDPWS Sec. 4.2.3 to determine LRFD factored unit resistance.

^b For framing grades other than Douglas-Fir Larch or Southern Pine, reduced nominal shear capacities shall be determined by multiplying the tabulated nominal unit shear capacity by the Specific Gravity Adjustment Factor = [1 - (0.5 - G)], where G = Specific Gravity of the framing lumber from the NDS. The Specific Gravity Adjustment Factor shall not be greater than 1. ^c Fasteners at intermediate framing members shall be spaced at 12 in. on center except that where spans are greater than 32 in. they shall be spaced at 6 in. on center.

^c Fasteners at intermediate framing members shall be spaced at 12 in. on center except that where spans are greater than 32 in. they shall be spaced at 6 in. on center.

^d Maximum nominal shear for Cases 3 through 6 is limited to 2310 lb/ft.

^e Where 10d nails are spaced at 3 in. or less on center and penetrate framing by more than 1-5/8 in., adjoining panel edges shall have 3 in. nominal width framing and panel edge nails shall be staggered.

Table 12.2-2b Nominal Unit Shear Values (kN/m) for Seismic Forces on Horizontal Wood Diaphragms

Panel Grade	Fastener		Minimum nominal panel thickness (mm)	Minimum nominal width of framing (mm)	Lines of fasteners	Blocked Diaphragms ^{a,b}					
	Type	Minimum penetration in framing (mm)				Fastener spacing (mm) at diaphragm boundaries (all Cases), at continuous panel edges parallel to load (Cases 3 and 4) and at all panel edges (Cases 5 and 6) ^{c,d}					
						100		65		50	
						Spacing per line at other panel edges (mm)					
						150	100	100	75	75	50
Structural I	10d ^e common	38	18	75	2	19.1	25.4	27.4	35.9	—	—
				100	2	22.0	28.5	31.4	41.2	—	—
				100	3	27.4	38.2	40.1	52.8	—	—
	14 ga staples	50	18	75	2	17.5	17.5	24.5	26.3	30.4	35.0
				100	3	24.5	26.3	33.3	39.5	42.0	52.5
				—	—	—	—	—	—	—	—
Sheathing, single floor and other grades covered in PS 1 and PS 2	10d ^c common	38	18	75	2	18.8	25.4	27.4	35.8	—	—
				100	2	22.0	28.5	31.4	40.6	—	—
				100	3	27.4	38.2	40.0	44.1	—	—
	14 ga staples	50	18	75	2	17.5	17.5	24.1	26.3	29.9	35.0
				100	3	24.1	26.3	32.8	39.5	40.9	44.1
				—	—	—	—	—	—	—	—

^a Nominal unit shear values shall be adjusted in accordance with AF&PA SDPWS Sec. 4.2.3 to determine LRFD factored unit resistance.

^b For framing grades other than Douglas-Fir Larch or Southern Pine, reduced nominal shear capacities shall be determined by multiplying the tabulated nominal unit shear capacity by the Specific Gravity Adjustment Factor = $[1 - (0.5 - G)]$, where G = Specific Gravity of the framing lumber from the NDS. The Specific Gravity Adjustment Factor shall not be greater than 1.

^c Fasteners at intermediate framing members shall be spaced at 300 mm on center except that where spans are greater than 810 mm they shall be spaced at 150 mm on center.

^d Maximum nominal shear for Cases 3 through 6 is limited to 2310 lb/ft.

^e Where 10d nails are spaced at 75 mm or less on center and penetrate framing by more than 41 mm, adjoining panel edges shall have 75 mm nominal width framing and panel edge nails shall be staggered.

Table 12.2-3a Nominal Unit Shear Values (lb/ft) for Seismic Forces on Wood Structural Panel Shear Walls^{a,b,c}

Panel Grade	Panel Thickness (in.)	Minimum Penetration in Framing (in.)	Fastener Size	Fastener Spacing at Panel Edges (in.)			
				6	4	3	2 ^d
Panel Applied Over 1/2 in. or 5/8 in. Gypsum Sheathing (common or hot-dipped galvanized box nails)							
Structural I	3/8	1-1/4	8d	400	600	780	1020
	3/8	1-3/8	10d ^e	460	720	920	1220
	7/16	1-3/8	10d ^e	510	780	1020	1340
	15/32	1-3/8	10d ^e	550	860	1110	1460
Sheathing, Panel Siding, and Other Grades Covered in PS 1 and PS 2	3/8	1-1/4	8d	400	600	780	1020
	3/8	1-3/8	10d ^e	450	650	820	1060
	7/16	1-3/8	10d ^e	480	710	910	1170
	15/32	1-3/8	10d ^e	520	750	980	1280
Panel Applied Over 1/2 in. or 5/8 in. Gypsum Sheathing (hot-dipped galvanized casing nails)							
Panel Siding as Covered in PS 1	3/8	1-1/4	8d	280	420	550	720
	3/8	1-3/8	10d ^e	320	480	620	820
Panel Applied Directly to Framing							
Structural I	3/8	2	14 ga staple	290	450	600	890
	7/16	2	14 ga staple	420	620	820	1230
Sheathing, Panel Siding, and Other Grades Covered in PS 1 and PS 2	3/8	2	14 ga staple	260	380	510	770
	7/16	2	14 ga staple	350	550	720	1080
	15/32	2	14 ga staple	420	620	820	1230
^a Nominal unit shear values shall be adjusted in accordance with AF&PA SDPWS Sec. 4.3.3 to determine LRFD factored unit resistance. ^b For framing grades other than Douglas-Fir Larch or Southern Pine, reduced nominal shear capacities shall be determined by multiplying the tabulated nominal unit shear capacity by the Specific Gravity Adjustment Factor = [1 - (0.5 - G)], where G = Specific Gravity of the framing lumber from the NDS. The Specific Gravity Adjustment Factor shall not be greater than 1. ^c Where panels are applied on both faces of a wall and fastener spacing is less than 6 in. on center on either side, panel joints shall be offset to fall on different framing members or framing shall be 3 in. nominal or wider and fasteners on each side of joint shall be staggered. ^d Framing at adjoining panel edges shall be 3 in. nominal or wider and fasteners shall be staggered where nails are spaced 2 in. on center. ^e Where 10d nails are spaced at 3 in. or less on center and penetrate framing by more than 1-5/8 in., adjoining panel edges shall have 3 in. nominal width framing and panel edge nails shall be staggered.							

Table 12.2-3b Nominal Unit Shear Values (kN/m) for Seismic Forces on Wood Structural Panel Shear Walls^{a,b,c}

Wood Structure Design Requirements

Panel Grade	Panel Thickness (mm)	Minimum Penetration in Framing (mm)	Fastener Size	Fastener Spacing at Panel Edges (mm)			
				150	100	75	50 ^d
Panel Applied Over 12.7 mm or 15.9 mm Gypsum Sheathing (common or hot-dipped galvanized box nails)							
Structural I	9.5	32	8d	5.8	8.8	11.4	14.9
	9.5	35	10d ^e	6.7	10.5	13.4	17.8
	11	35	10d ^e	7.4	11.4	14.9	19.6
	12	35	10d ^e	8	12.6	16.2	21.3
Sheathing, Panel Siding, and Other Grades Covered in PS 1 and PS 2	9.5	32	8d	5.8	8.8	11.4	14.9
	9.5	35	10d ^e	6.6	9.5	12.0	15.5
	11	35	10d ^e	7.0	10.4	13.3	17.1
	12	35	10d ^e	7.6	10.9	14.3	18.7
Panel Applied Over 12.7 mm or 15.9 mm Gypsum Sheathing (hot-dipped galvanized casing nails)							
Panel Siding as Covered in PS 1	9.5	32	8d	4.1	6.1	8.0	10.5
	9.5	35	10d ^e	4.7	7.0	9.0	12
Panel Applied Directly to Framing							
Structural I	9.5	2	14 ga staple	4.2	6.6	8.8	13.0
	11	2	14 ga staple	6.1	9.0	12.0	18.0
Sheathing, Panel Siding, and Other Grades Covered in PS 1 and PS 2	9.5	2	14 ga staple	3.8	5.5	7.4	11.2
	11	2	14 ga staple	5.1	8.0	10.5	15.8
	12	2	14 ga staple	6.1	9.0	12.0	18.0
^a Nominal unit shear values shall be adjusted in accordance with AF&PA SDPWS Sec. 4.3.3 to determine LRFD factored unit resistance. ^b For framing grades other than Douglas-Fir Larch or Southern Pine, reduced nominal shear capacities shall be determined by multiplying the tabulated nominal unit shear capacity by the Specific Gravity Adjustment Factor = [1 - (0.5 - G)], where G = Specific Gravity of the framing lumber from the NDS. The Specific Gravity Adjustment Factor shall not be greater than 1. ^c Where panels are applied on both faces of a wall and fastener spacing is less than 150 mm on center on either side, panel joints shall be offset to fall on different framing members or framing shall be 75 mm nominal or wider and fasteners on each side of joint shall be staggered. ^d Framing at adjoining panel edges shall be 75 mm nominal or wider and fasteners shall be staggered where nails are spaced 50 mm on center. ^e Where 10d nails are spaced at 75 mm or less on center and penetrate framing by more than 41 mm, adjoining panel edges shall have 75 mm nominal width framing and panel edge nails shall be staggered.							

12.3 GENERAL DESIGN REQUIREMENTS FOR ENGINEERED WOOD CONSTRUCTION

The proportioning, design, and detailing of engineered wood systems, members, and connections shall be in accordance with the reference documents, except as modified by Sec. 12.2.3 and 12.2.4.

12.3.1 Framing. All wood columns and posts shall be framed to provide full end bearing. Alternatively, column and post end connections shall be designed to resist the full compressive loads, neglecting all end bearing capacity. Continuity of wall top plates or provision for transfer of induced axial load forces is required. When offsets occur in the wall line, portions of the shear wall on each side of the offset shall be considered as separate shear walls unless provisions for force transfer around the offset are provided.

12.4 CONVENTIONAL LIGHT-FRAME CONSTRUCTION

Conventional light-frame construction is a system constructed entirely of repetitive horizontal and vertical wood light-framing members selected from tables in NF&PA T903 and complying with the framing and bracing requirements of the IRC except as modified by the provisions in this section.

The requirements of this section are based on platform construction. Other framing systems must have equivalent detailing to ensure force transfer, continuity, and compatible deformation.

Where a structure of otherwise conventional light-frame construction contains structural elements that do not comply with the requirements of this section, such elements shall satisfy the requirements for engineered wood construction as indicated in Sec. 12.2.

12.4.1 Limitations

12.4.1.1 General. Structures with concrete or masonry walls above the basement story shall not be considered to be conventional light-frame construction. Construction with concrete and masonry basement walls shall be in accordance with the IRC or equivalent.

Conventional light-frame construction is limited to structures with bearing wall heights not exceeding 10 ft (3 m) and the number of stories prescribed in Table 12.4-1. The gravity dead load of the construction is limited to 15 psf (0.7 kN/m²) for roofs and exterior walls and 10 psf (0.5 kN/m²) for floors and partitions and the gravity live load is limited to 40 psf (1.9 kN/m²). Figure 12.4-1 illustrates the definition of story above grade.

Exceptions: Masonry veneer is acceptable for:

1. The first story above grade, or the first two stories above grade where the lowest story has concrete or masonry walls, for structures assigned to Seismic Design Category B or C.
2. The first two stories above grade, or the first three stories above grade where the lowest story has concrete or masonry walls, for structures assigned to Seismic Design Category B, if wood structural panel wall bracing is used and the length of bracing provided is 1.5 times the length required by Table 12.4-2.

Table 12.4-1 Braced Walls for Conventional Light-Frame Construction

Seismic Design Category	Maximum Distance Between Braced Walls	Maximum Number of Stories Permitted Above Grade ^a
A ^b	35 ft (10.7 m)	3
B	35 ft (10.7 m)	3
C	25 ft (7.6 m)	2
D and	25 ft (7.6 m)	1 ^c

Table 12.4-1 Braced Walls for Conventional Light-Frame Construction

Seismic Design Category	Maximum Distance Between Braced Walls	Maximum Number of Stories Permitted Above Grade ^a
E (Seismic Use Group I)		
E (Seismic Use Group II) and F	Conventional construction is not permitted; design in accordance with Sec. 12.2 is required.	

^a A cripple stud wall is considered to be a story above grade. Maximum bearing wall height shall not exceed 10 ft (3 m).

^b See exceptions in Sec. 1.1.2.1.

^c Detached one- and two-family dwellings are permitted to be two stories above grade.

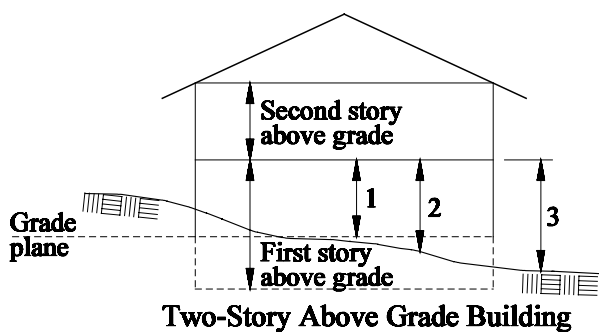

The lower floor level is classified as the first story if the finished floor surface of the floor level above is:

1. More than 6 ft (1.8 m) above the grade plane;
2. More than 6 ft (1.8 m) above grade for more than 50% of building perimeter; or
3. More than 12 ft (3.6 m) above grade at any point.

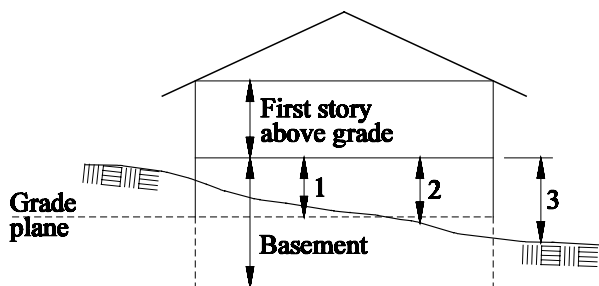

The upper floor level is classified as the first story if the finished floor surface of the floor level above is:

1. Not more than 6 ft (1.8 m) above the grade plane;
2. Not more than 6 ft (1.8 m) above grade for more than 50% of building perimeter; and
3. Not more than 12 ft (3.6 m) above grade at any point.

Figure 12.4-1 Definition of Story Above Grade.

12.4.1.2 Irregular structures. In Seismic Design Categories C, D, and E (Seismic Use Group I), irregular structures of conventional light-frame construction shall have a seismic-force-resisting system that is designed in accordance with Sec. 12.2 to resist the forces determined in accordance with Sec. 4.4. A structure shall be considered to have an irregularity where at least one of the conditions described in this section is present.

12.4.1.2.1 Out-of-plane offset. A structure shall be considered to have an irregularity where exterior braced wall panels are not in one plane vertically from the foundation to the uppermost story in which they are required. See Figure 12.4-2.

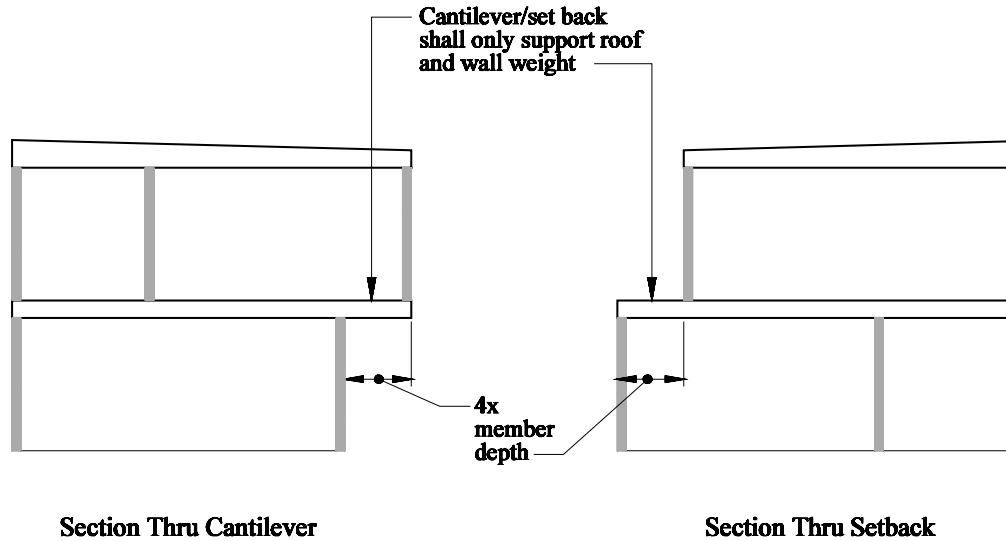

Figure 12.4-3 Permitted Cantilevers and Setbacks.

12.4.1.2.2 Unsupported diaphragm. A structure shall be considered to have an irregularity where a section of floor or roof is not laterally supported by braced wall lines on all edges. See Figure 12.4-4.

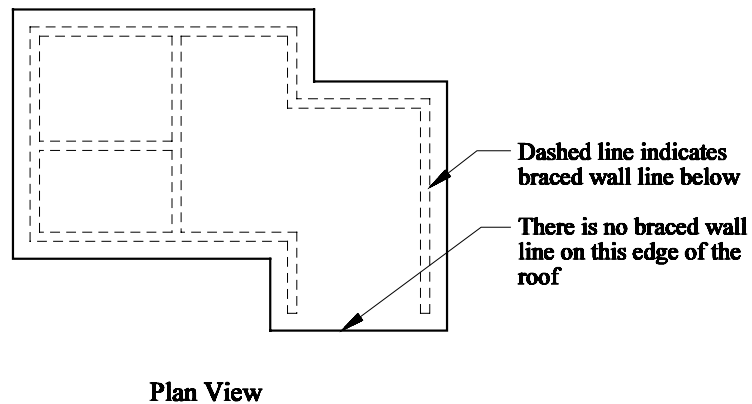

Figure 12.4-4 Unsupported Diaphragm Irregularity.

Exception: Portions of roofs or floors that support braced wall panels above shall be permitted to extend up to 6 ft (1.8 m) beyond a braced wall line. See Figure 12.4-5.

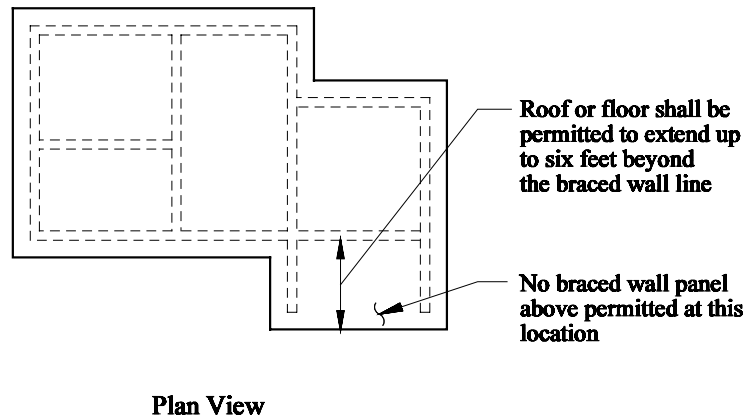

Figure 12.4-5 Permitted Diaphragm Extension.

12.4.1.2.3 Opening in wall below. A structure shall be considered to have an irregularity where the end of a required braced wall panel extends more than 1 ft (0.3 m) over an opening in the wall below. This requirement is applicable to braced wall panels offset in plane and to braced wall panels offset out of plane as permitted by the exception to Sec. 12.4.1.2.1. See Figure 12.4-6.

Exception: Braced wall panels shall be permitted to extend over an opening not more than 8 ft (2.4 m) in width where the header is a 4 by 12 in. nominal (actual: 3.5 by 11.25 in.; 89 by 286 mm) or larger member.

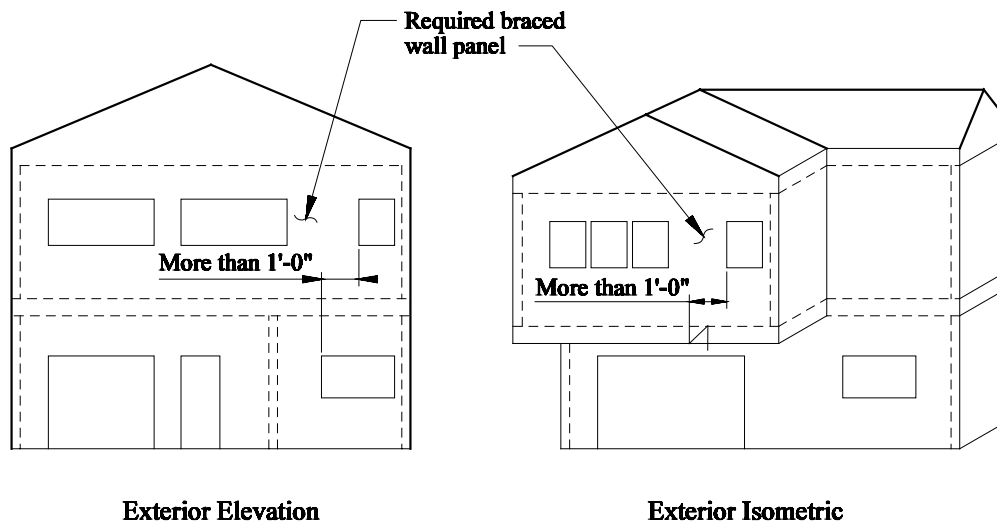

Figure 12.4-6 Opening in Wall Below Irregularity.

12.4.1.2.4 Vertical offset in diaphragm. A structure shall be considered to have an irregularity where portions of a floor level are vertically offset such that the framing members on either side of the offset cannot be lapped or tied together in an approved manner. See Figure 12.4-7.

Exception: This condition need not be considered for framing supported directly by foundations.

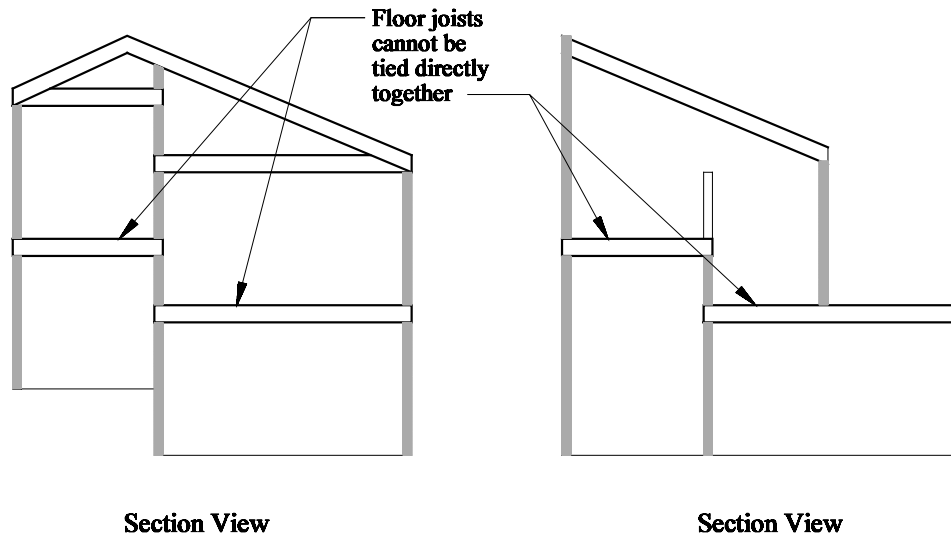

Figure 12.4-7 Vertical Offset Irregularity.

12.4.1.2.5 Non perpendicular walls. A structure shall be considered to have an irregularity where braced wall lines are not perpendicular to each other. See Figure 12.4-8.

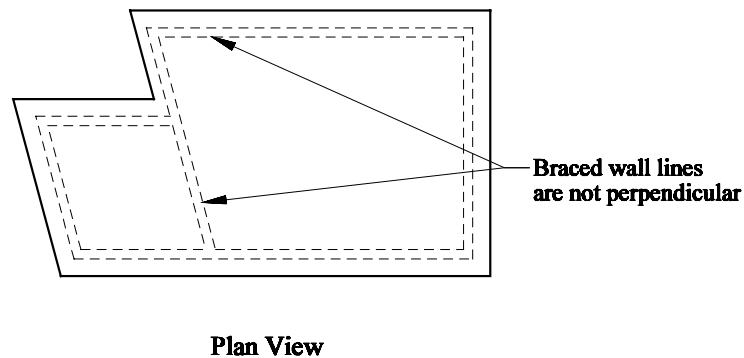

Figure 12.4-8 Non perpendicular Walls Irregularity.

12.4.1.2.6 Large diaphragm opening. A structure shall be considered to have an irregularity where floor or roof diaphragms have openings with a maximum dimension greater than 50 percent of the distance between lines of bracing or with an area greater than 25 percent of the area between orthogonal pairs of braced wall lines. See Figure 12.4-9.

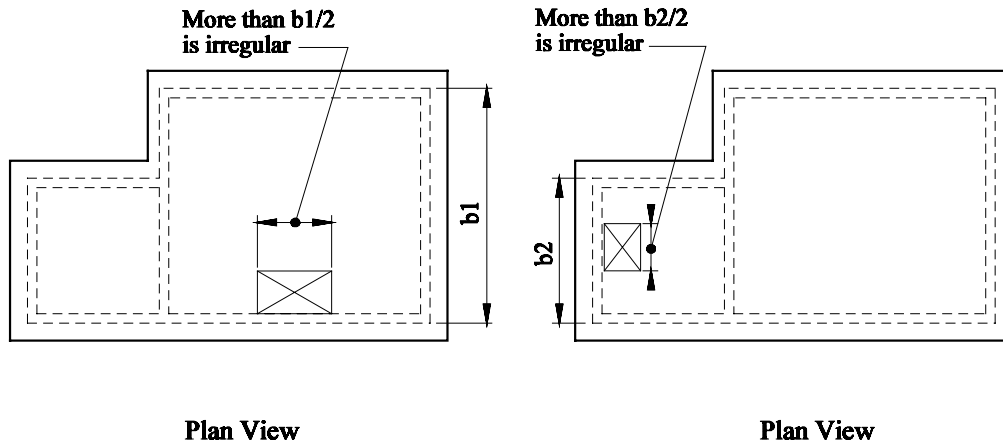

Figure 12.4-9 Diaphragm Opening Irregularity.

12.4.1.2.7 Stepped foundation. A structure shall be considered to have an irregularity where the shear walls from the foundation to the floor above vary in height by more than 6 ft (1.8 m).

12.4.2 Braced walls. The following are the minimum braced wall requirements.

12.4.2.1 Spacing between braced wall lines. Interior and exterior braced wall lines shall be located at the spacing indicated in Table 12.4-1.

12.4.2.2 Braced wall line sheathing. All braced wall lines shall be braced by one of the types of sheathing prescribed in Table 12.4-2. The required sum of lengths of braced wall panels at each braced wall line is prescribed in Table 12.4-2. Braced wall panels shall be distributed along the length of the braced wall line with sheathing placed at each end of the wall or partition or as near thereto as possible. All panel sheathing joints shall occur over studs or blocking. Sheathing shall be fastened to all studs and top and bottom plates and at panel edges occurring over blocking. All wall framing to which sheathing used for bracing is applied shall be 2 in. nominal (actual: 1.5 in.; 38 mm) or thicker members.

Cripple walls shall be braced as required for braced wall lines and shall be considered an additional story. Where interior post-and-girder framing is used, the capacity of the braced wall panels at exterior cripple walls shall be increased to compensate for the length of interior braced wall eliminated by increasing the length of the sheathing or by increasing the number of fasteners.

Table 12.4-2 Minimum Length of Wall Bracing for each 25 ft (7.6 m) of Braced Wall Line^a

Story Location	Sheathing Type ^b	$S_{DS} < 0.25$	$0.25 \leq S_{DS} < 0.375$	$0.375 \leq S_{DS} < 0.50$	$0.50 \leq S_{DS} < 0.75$	$0.75 \leq S_{DS} \leq 1.0^c$
Top or only story above grade	G-P ^d	8'-0" (2440 mm)	8'-0" (2440 mm)	10'-8" (3250 mm)	14'-8" (4470 mm)	18'-8" ^e (5690 mm)
	S-W ^f	4'-0" (1220 mm)	4'-0" (1220 mm)	5'-4" (1625 mm)	8'-0" (2440 mm)	9'-4" ^e (2845 mm)
Story below top story above grade	G-P ^d	10'-8" (3250 mm)	14'-8" (4470 mm)	18'-8" ^e (6590 mm)	NP	NP
	S-W ^f	5'-4" (1625 mm)	6'-8" (2030 mm)	10'-8" ^e (3250 mm)	13'-4" ^e (4065 mm)	17'-4" ^e (5280 mm)
Bottom story of 3 stories above grade	G-P ^d	14'-8" (4470 mm)	Conventional construction is not permitted; design in accordance with Sec. 12.2 is required.			
	S-W ^f	8'-0" (2440 mm)				

^a Minimum length of panel bracing on one face of wall for S-W sheathing or both faces of wall for G-P sheathing; h/b ratio shall not exceed 2/1, except that structures in Seismic Design Category B need only meet the requirements of Sec. R602.10.3 of the IRC. For S-W panel bracing of the same material on two faces of the wall, the minimum length is permitted to be one half the tabulated value but the h/b ratio shall not exceed 2/1 and design for uplift is required.

^b G-P = gypsumboard, fiberboard, particleboard, lath and plaster, or gypsum sheathing boards; S-W = wood structural panels and diagonal wood sheathing. NP = not permitted.

^c Where S_{DS} is greater than 1.0, conventional construction is not permitted.

^d Nailing of G-P sheathing shall be provided as follows at all panel edges at studs, at top and bottom plates, and at blocking, where it occurs:

For 1/2 in. (13 mm) gypsum board, 5d (0.086 in.; 2.2 mm) coolers at 7 in. (178 mm) on center;

For 5/8 in. (16mm) gypsum board, 6d (0.092 in.; 2.3 mm) at 7 in. (178 mm) on center;

For gypsum sheathing board, 1-3/4 in. (44 mm) long by 7/16 in. (11 mm) head, diamond point galvanized at 4 in. (100 mm) on center;

For gypsum lath, No. 13 gauge (0.092 in.; 2.3 mm) by 1-1/8 in. (29 mm) long, 19/64 in. (7.5 mm) head, plasterboard at 5 in. (125 mm) on center;

For Portland cement plaster, No. 11 gauge (0.120 in.; 3 mm) by 1-1/2 in. (89 mm) long, 7/16 in. (11 mm) head at 6 in. (150 mm) on center;

For fiberboard and particleboard, No. 11 gauge (0.120 in.; 3 mm) by 1-1/2 in. (38 mm) long, 7/16 in. (11 mm) head, galvanized at 3 in. (76 mm) on center.

^e Applies to one- and two-family detached dwellings only.

^f Nailing of S-W sheathing at a maximum of 6 inch spacing shall be provided at all panel edges to studs, to top and bottom plates, and blocking, where it occurs. At intermediate supports space nails at 6 inch spacing where 3/8 inch and 7/16 inch thick panels are installed on studs spaced 24 inches on center with the strong axis parallel to studs, and at a maximum 12 inch spacing for all other conditions. Minimum nail sizes are 6d common for 3/8" thick sheathing, and 8d common for 7/16 inch and 15/32 inch thick sheathing.

12.4.2.3 Attachment

12.4.2.3.1 Fastening of wall panel sheathing. Fastening of braced wall panel sheathing shall not be less than the minimum indicated by footnotes d and f of Table 12.4-2.

12.4.2.3.2 Nailing of diagonal boards. Diagonal boards of 1 inch nominal thickness and 6 inch nominal width shall be nailed to top and bottom plates and to studs located at braced wall ends with not less than three 8d common nails, and at intermediate supports with not less than two 8d common nails. Diagonal boards of 1 inch nominal thickness and 8 inch or greater nominal width shall be nailed to top and bottom plates and to studs located at braced wall ends with not less than four 8d common nails, and at intermediate supports with not less than three 8d common nails.

12.4.2.3.3 Adhesives. Adhesive attachment of wall sheathing is not permitted.

12.4.3 Detailing requirements. The following requirements for framing and connection details shall apply as a minimum.

12.4.3.1 Wall anchorage. Anchorage of braced wall line sills to concrete or masonry foundations shall be provided. Anchors shall be spaced at not more than 4 ft (1.2 m) on center for structures over two stories in height. For Seismic Design Categories C, D, and E, plate washers not smaller than ¼ by 3 by 3 in. in size shall be provided between the foundation sill plate and the nut. Other anchorage devices having equivalent capacity shall be permitted.

12.4.3.2 Top plates. Stud walls shall be capped with double top plates installed to provide overlapping at corners and intersections. End joints in double top plates shall be offset at least 4 ft (1220 mm). Single top plates shall be permitted to be used where they are spliced by framing devices providing capacity equivalent to the lapped splice prescribed for double top plates (Sec.12.4.3.4).

12.4.3.3 Bottom plates. Studs shall have full bearing on a 2 in. nominal (actual: 1.5 in.; 38 mm) or thicker plate or sill having a width at least equal to the width of the studs.

12.4.3.4 Braced wall panel connections. Provision shall be made to transfer forces from roofs and floors to braced wall panels and from the braced wall panels in upper stories to the braced wall panels in the story below. Where platform framing is used, such transfer at braced wall panels shall be accomplished in accordance with the following:

1. All braced wall panel top and bottom plates shall be fastened to joists, rafters, or full depth blocking. Braced wall panels shall be extended and fastened to roof framing at intervals not to exceed 50 ft (15 m).

Exception: Where roof trusses are used, provision shall be made to transfer lateral forces from the roof diaphragm to the braced wall.

2. Bottom plate fastening to joists or blocking below shall be with not fewer than three 16d (0.162 by 3½ in.; 4 by 89 mm) nails at 16 in. (400 mm) on center.
3. Blocking shall be nailed to the top plate below with not fewer than three 8d (0.131 by 2½ in.; 3 by 64 mm) toenails per block.
4. Joists parallel to the top plates shall be nailed to the top plate with not fewer than 8d (0.131 by 2½ in.; 3 by 64 mm) toenails at 6 in. (150 mm) on center.

In addition, top plate laps shall be nailed with not fewer than eight 16d (0.162 by 3½ in.; 4 by 89 mm) face nails on each side.

12.4.3.5 Foundations supporting braced wall panels. For structures with maximum plan dimensions not over 50 ft (15 m), foundations supporting braced wall panels are required at exterior walls only. Structures with plan dimensions greater than 50 ft (15 m) shall, in addition, have foundations supporting all required interior braced wall panels. Foundation-to-braced-wall connections shall be made at every foundation supporting a braced wall panel. The connections shall be distributed along the length of the braced wall line. Where all-wood foundations are used, the force transfer shall be determined based on calculation and shall have capacity greater than or equal to that for the connections required by Sec. 12.4.3.1.

12.4.3.6 Stepped foundations. Where the height of a required braced wall panel extending from foundation to floor above varies more than 4 ft (1.2 m) (see Figure 12.4-10), the following construction shall be used:

1. Where only the bottom of the footing is stepped and the lowest floor framing rests directly on a sill bolted to the footings, the requirements of Sec. 12.4.3.1 shall apply.
2. Where the lowest floor framing rests directly on a sill bolted to a footing not less than 8 ft (2.4 m) in length along a line of bracing, the line shall be considered to be braced. The double plate of the cripple stud wall beyond the segment of footing extending to the lowest framed floor shall be spliced to the sill plate with metal ties, one on each side of the sill and plate, not less than 0.058 in. (16 gauge; 2 mm) thick by 1.5 in. (38 mm) wide by 48 in. (1220 mm) long with eight 16d (0.162 by 3.5 in.; 4 by 89 mm) common nails on each side of the splice location. Steel used shall have a minimum yield of 33,000 psi (228 MPa), such as ASTM A 653 SS, Grade 33, ASTM A 792 SS, Grade 33, or ASTM A 875 SS, Grade 33.
3. Where cripple walls occur between the top of the footing and the lowest floor framing, the bracing requirements for a story shall apply.

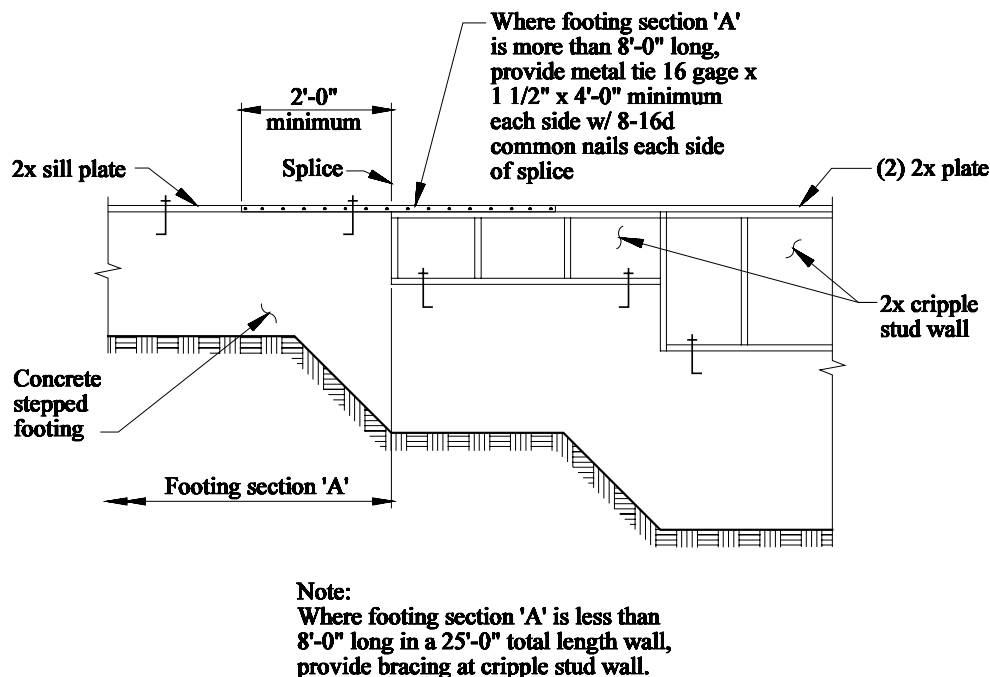

Figure 12.4-10 Detail for Stepped Foundation.

12.4.3.7 Detailing for openings in diaphragms. For openings with a dimension greater than 4 ft (1.2 m), or openings in structures assigned to Seismic Design Category D or E, the following minimum detail shall be provided. Blocking beyond headers and metal ties not less than 0.058 in. (16 gauge; 2 mm) thick by 1.5 in. (38 mm) wide by 48 in. (1220 mm) long with eight 16d (0.162 by 3.5 in.; 4 by 89 mm) common nails on each side of the header-joint intersection shall be provided (see Figure 12.4-11). Steel used shall have a minimum yield of 33,000 psi (228 MPa), such as ASTM A 653 SS, Grade 33, ASTM A 792 SS, Grade 33, or ASTM A 875 SS, Grade 33.

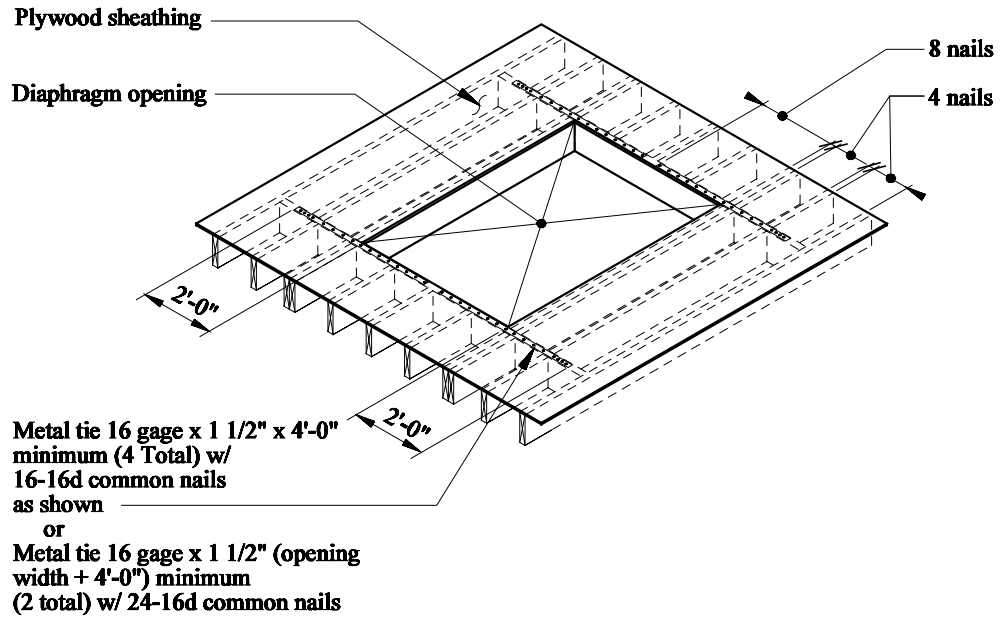

Figure 12.4 -11 Detail for Diaphragm Opening.

Chapter 13

SEISMICALLY ISOLATED STRUCTURE DESIGN REQUIREMENTS

13.1 GENERAL

13.1.1 Scope.

Every seismically isolated structure and every portion thereof shall be designed and constructed in accordance with the requirements of these *Provisions* as modified by this chapter.

13.1.2 Definitions.

Component: See Sec. 1.1.4.

Dead load: See Sec. 4.1.3.

Design displacement: The design earthquake lateral displacement, excluding additional displacement due to actual and accidental torsion, required for design of the isolation system.

Displacement restraint system: A collection of structural elements that limits lateral displacement of seismically isolated structures due to maximum considered earthquake ground shaking.

Effective damping: The value of equivalent viscous damping consistent with the energy dissipated during cyclic response of the isolation system.

Effective stiffness: The value of lateral force in the isolation system, or an element thereof, divided by the corresponding lateral displacement.

Isolation interface: The boundary between the upper portion of the structure, which is isolated, and the lower portion of the structure, which is assumed to move rigidly with the ground.

Isolation system: The collection of structural elements that includes all individual isolator units, all structural elements that transfer force between elements of the isolation system, and all connections to other structural elements. The isolation system also includes the wind-restraint system, energy-dissipation devices, and/or the displacement restraint system where such systems or devices are used to satisfy the design requirements of Chapter 13.

Isolator unit: A horizontally flexible and vertically stiff structural element of the isolation system that permits large lateral deformations under design seismic load. An isolator unit is permitted to be used either as part of or in addition to the weight-supporting system of the structure.

Live load: See Sec. 4.1.3.

Maximum considered earthquake ground motion: See Sec. 3.1.3.

Maximum displacement: The maximum considered earthquake lateral displacement, excluding additional displacement due to actual and accidental torsion.

Occupancy importance factor: See Sec. 1.1.4.

Registered design professional: See Sec. 2.1.3.

Seismic-force-resisting system: See Sec. 1.1.4.

Seismic Use Group: See Sec. 1.1.4.

Story: See Sec. 4.1.3.

Structure: See Sec. 1.1.4.

Total design displacement: The design earthquake lateral displacement, including additional displacement due to actual and accidental torsion, required for design of the isolation system or an element thereof.

Total maximum displacement: The maximum considered earthquake lateral displacement, including additional displacement due to actual and accidental torsion, required for verification of the stability of the isolation system or elements thereof, design of structure separations, and vertical load testing of isolator unit prototypes.

Wind-restraint system: The collection of structural elements that provides restraint of the seismically isolated structure for wind loads. The wind-restraint system may be either an integral part of isolator units or a separate device.

13.1.3 Notation

B_D	Numerical coefficient as set forth in Table 13.3-1 for effective damping equal to β_D .
B_M	Numerical coefficient as set forth in Table 13.3-1 for effective damping equal β_M
b	The shortest plan dimension of the structure measured perpendicular to d .
C_d	See Sec. 4.1.4.
D	See Sec. 4.1.4.
D_D	Design displacement at the center of rigidity of the isolation system in the direction under consideration as prescribed by Eq. 13.3-1.
D'_D	Design displacement at the center of rigidity of the isolation system in the direction under consideration applicable to dynamic procedures, as prescribed by Eq. 13.4-1.
D_M	Maximum displacement at the center of rigidity of the isolation system in the direction under consideration, as prescribed by Eq. 13.3-3.
D'_M	Maximum displacement at the center of rigidity of the isolation system in the direction under consideration applicable to dynamic procedures, as prescribed by Eq. 13.4-2.
D_{TD}	Total design displacement of an element of the isolation system including both translational displacement at the center of rigidity and the component of torsional displacement in the direction under consideration as prescribed by Eq. 13.3-5.
D_{TM}	Total maximum displacement of an element of the isolation system including both translational displacement at the center of rigidity and the component of torsional displacement in the direction under consideration as prescribed by Eq. 13.3-6.
d	The longest plan dimension of the structure.
E	See Sec. 4.1.4.
E_{loop}	Energy dissipated in an isolator unit or damping device during a full cycle of reversible load over a test displacement range from Δ^+ to Δ^- as measured by the area enclosed by the loop of the force-deflection curve.
e	The actual eccentricity measured in plan between the center of mass of the structure above the isolation interface and the center of rigidity of the isolation system, plus accidental eccentricity taken as 5 percent the maximum building dimension perpendicular to the direction of the force under consideration.
F^+	Positive force in an isolator unit during a single cycle of prototype testing at a displacement amplitude of Δ^+ .

F	Maximum negative force in an isolator unit during a single cycle of prototype testing a displacement amplitude of Δ .
g	Acceleration due to gravity.
h_i	See Sec. 5.1.3
h_{sx}	See Sec. 4.1.4.
h_x	See Sec. 5.1.3.
Level i	See Sec. 4.1.4.
K_{Dmax}	Maximum effective stiffness of the isolation system at the design displacement in the horizontal direction under consideration as prescribed by Eq. 13.6-3.
K_{Dmin}	Minimum effective stiffness of the isolation system at the design displacement in the horizontal direction under consideration as prescribed by Eq. 13.6-4.
K_{Mmax}	Maximum effective stiffness of the isolation system at the maximum displacement in the horizontal direction under consideration as prescribed by Eq. 13.6-5.
K_{Mmin}	Minimum effective stiffness of the isolation system at the maximum displacement in the horizontal direction under consideration, as prescribed by Eq. 13.6-6.
k_{eff}	Effective stiffness of an isolator unit, as prescribed by Eq. 13.6-1.
L	The effect of live load.
R	See Sec. 4.1.4.
R_I	Numerical coefficient related to the type of seismic-force-resisting system above the isolation system as defined in Sec. 13.3.3.2 for seismically isolated structures.
S_I	See Sec. 3.1.4.
S_{DI}	See Sec. 3.1.4.
S_{DS}	See Sec. 3.1.4.
S_{MI}	See Sec. 3.1.4.
T_D	Effective period, in seconds, of the seismically isolated structure at the design displacement in the direction under consideration as prescribed by Eq. 13.3-2.
T_M	Effective period, in seconds, of the seismically isolated structure at the maximum displacement in the direction under consideration as prescribed by Eq. 13.3-4.
V_b	The total lateral seismic design force on elements of the isolation system or elements below the isolation system as prescribed by Eq. 13.3-7.
V_s	The total lateral design force on elements above the isolation system as prescribed by Eq. 13.3-8.
W	See Sec. 1.1.5. For calculation of the period of seismically isolated structures, the seismic weight above the isolation system.
w_i	See Sec. 4.1.4.
w_x	See Sec. 1.1.5.
Level x	See Sec. 1.1.5.
y	The distance between the center of rigidity of the isolation system rigidity and the element of interest measured perpendicular to the direction of seismic loading under consideration.

β_D	Effective damping of the isolation system at the design displacement as prescribed by Eq. 13.6-7.
β_M	Effective damping of the isolation system at the maximum displacement as prescribed by Eq. 13.6-8.
β_{eff}	Effective damping of the isolation system as prescribed by Eq. 13.6-2.
Δ	The maximum considered earthquake lateral displacement of the structure above the isolation system.
Δ^+	Maximum positive displacement of an isolator unit during each cycle of prototype testing.
Δ^-	Maximum negative displacement of an isolator unit during each cycle of prototype testing.
ΣE_D	Total energy dissipated in the isolation system during a full cycle of response at the design displacement, D_D .
ΣE_M	Total energy dissipated on the isolation system during a full cycle of response at the maximum displacement, D_M .
$\Sigma F_D^+ _{max}$	Sum, for all isolator units, of the maximum absolute value of force at a positive displacement equal to D_D .
$\Sigma F_D^+ _{min}$	Sum, for all isolator units, of the minimum absolute value of force at a positive displacement equal to D_D .
$\Sigma F_D^- _{max}$	Sum, for all isolator units, of the maximum absolute value of force at a negative displacement equal to D_D .
$\Sigma F_D^- _{min}$	Sum, for all isolator units, of the minimum absolute value force at a negative displacement equal to D_D .
$\Sigma F_M^+ _{max}$	Sum, for all isolator units, of the maximum absolute value of force at a positive displacement equal to D_M .
$\Sigma F_M^+ _{min}$	Sum, for all isolator units, of the minimum absolute value of force at a positive displacement equal to D_M .
$\Sigma F_M^- _{max}$	Sum, for all isolator units, of the minimum absolute value of force at a negative displacement equal to D_M .
$\Sigma F_M^- _{min}$	Sum, for all isolator units, of the minimum absolute value of force at a negative displacement equal to D_M .

13.2 GENERAL DESIGN REQUIREMENTS

13.2.1 Occupancy importance factor. The Occupancy Importance Factor shall be taken as 1.0 for a seismically isolated structure, regardless of the Seismic Use Group assigned in accordance with Sec. 1.2.

13.2.2 Configuration. The determination of structural configuration in accordance with Sec. 4.3.2 shall be based on the structural configuration above the isolation system.

13.2.3 Ground motion

13.2.3.1 Design spectra. Properly substantiated site-specific spectra shall be used for the design of all seismically isolated structures located on a Class F site or located at a site with S_I greater than 0.6.

Where site-specific spectra are used, the design spectrum for the design earthquake shall be developed in accordance with Sec. 3.4. Where site-specific spectra are not used, the design spectrum for the design

earthquake shall be developed in accordance with Sec. 3.3. The design spectrum for the maximum considered earthquake shall be taken as not less than 1.5 times the design spectrum for the design earthquake.

13.2.3.2 Time histories. Where response history procedures are used, ground motions shall consist of pairs of appropriate horizontal ground motion acceleration components that shall be selected and scaled from individual recorded events. Appropriate ground motions shall be selected from events having magnitudes, fault distance, and source mechanisms that are consistent with those that control the maximum considered earthquake. Where the required number of recorded ground motion pairs are not available, appropriate simulated ground motion pairs shall be used to make up the total number required. For each pair of horizontal ground motion components, an SRSS spectrum shall be constructed by taking the square root of the sum of the squares of the five-percent-damped response spectra for the scaled components (where an identical scale factor is applied to both components of a pair). Each pair of motions shall be scaled such that for each period between $0.5T_D$ and $1.25T_M$ (where T_D and T_M are defined in Sec. 13.3.2) the average of the SRSS spectra from all horizontal component pairs does not fall below 1.3 times the corresponding ordinate of the design response spectrum, determined in accordance with Sec. 13.2.3.1, by more than 10 percent.

13.2.4 Procedure selection. All seismically isolated structures shall be designed using the procedure in Sec. 13.3 or one of the procedures in Sec. 13.4, as permitted in this section.

13.2.4.1 Equivalent lateral force procedure. The equivalent lateral force procedure of Sec. 13.3 is permitted to be used for design of a seismically isolated structure provided that:

1. The structure is located at a site with S_I less than or equal to 0.6 ;
2. The structure is located on a Class A, B, C, or D site;
3. The structure above the isolation interface is not more than four stories or 65 ft (20 m) in height;
4. The effective period of the isolated structure, T_M , is less than or equal to 3.0 sec.
5. The effective period of the isolated structure, T_D , is greater than three times the elastic, fixed-base period of the structure above the isolation system as determined in Sec. 5.2.2.1;
6. The structure above the isolation system is of regular configuration; and
7. The isolation system meets all of the following criteria:
 - a. The effective stiffness of the isolation system at the design displacement is greater than one third of the effective stiffness at 20 percent of the design displacement,
 - b. The isolation system is capable of producing a restoring force as specified in Sec. 13.2.5.4,
 - c. The isolation system does not limit maximum considered earthquake displacement to less than the total maximum displacement.

13.2.4.2 Dynamic procedures. The dynamic procedures of Sec. 13.4 are permitted to be used for design of seismically isolated structures as indicated in this section.

13.2.4.2.1 Response spectrum procedure. The response spectrum procedure is permitted to be used for design of a seismically isolated structure provided that:

1. The structure is located on a Class A, B, C, or D site, and
2. The isolation system meets the criteria of Item 7 of Sec. 13.2.4.1.

13.2.4.2.2 Response history procedure. The response history procedure is permitted to be used for design of any seismically isolated structure.

13.2.4.3 Variations in material properties. The analysis of seismically isolated buildings, including the substructure, isolators and superstructure, shall consider variations in seismic isolator material

properties over the projected life of the building including changes due to aging, contamination, environmental exposure, loading rate, scragging, and temperature.

13.2.5 Isolation system

13.2.5.1 Environmental conditions. In addition to satisfying the requirements related to vertical and lateral loads induced by wind and earthquake, the isolation system shall be designed with consideration given to other environmental conditions including aging effects, creep, fatigue, operating temperature, and exposure to moisture or damaging substances.

13.2.5.2 Wind forces. Isolated structures shall resist design wind loads at all levels above the isolation interface. At the isolation interface, a wind restraint system shall be provided to limit lateral displacement in the isolation system to a value equal to that required between floors of the structure above the isolation interface.

13.2.5.3 Fire resistance. The fire resistance rating for the isolation system shall be consistent with the requirements of columns, walls, or other such elements in the same area of the structure.

13.2.5.4 Lateral-restoring force. The isolation system shall be configured to produce a restoring force such that the lateral force at the total design displacement is at least $0.025W$ greater than the lateral force at 50 percent of the total design displacement.

13.2.5.5 Displacement restraint. The isolation system is permitted to be configured to include a displacement restraint that limits lateral displacement due to the maximum considered earthquake to less than S_{MI}/S_{DI} times the total design displacement if the seismically isolated structure is designed in accordance with the following criteria where more stringent than the other requirements of Sec. 13.2:

1. Maximum considered earthquake response is calculated in accordance with Sec. 13.4 including explicit consideration of the nonlinear characteristics of both the isolation system and the structure above the isolation system;
2. The ultimate capacities of the isolation system and structural elements below the isolation system shall exceed the strength and displacement demands due to the maximum considered earthquake;
3. The structure above the isolation system is adequate for the stability and ductility demands due to the maximum considered earthquake; and
4. The displacement restraint does not become effective at a displacement less than 0.75 times the total design displacement unless it is demonstrated by analysis that earlier engagement does not result in unsatisfactory performance.

13.2.5.6 Vertical-load stability. Each element of the isolation system shall be designed to be stable under the maximum vertical load ($1.2D + 1.0L + E$) and the minimum vertical load ($0.8D - E$) when subjected to a horizontal displacement equal to the total maximum displacement. The dead load, D , and the live load, L , are defined in Sec. 13.1.2. The effect of seismic load, E , shall be determined in accordance with Sec. 4.2.2.1 except that S_{MS} shall be used in place of S_{DS} and the vertical loads that result from application of horizontal seismic forces, Q_E , shall be based on peak response due to the maximum considered earthquake.

13.2.5.7 Overturning. The factor of safety against global structural overturning at the isolation interface shall not be less than 1.0 for required load combinations. All gravity and seismic loading conditions shall be investigated. Seismic forces for overturning calculations shall be based on the maximum considered earthquake and the vertical restoring force shall be based on W , the seismic weight above the isolation interface, as defined in Sec. 5.2.1.

Local uplift of individual elements is permitted if the resulting deflections do not cause overstress or instability of the isolator units or other elements of the structure.

13.2.5.8 Inspection and replacement

Access for inspection and replacement of all components of the isolation system shall be provided.

1. A registered design professional shall complete a final series of inspections or observations of structure separation areas and components that cross the isolation interface prior to the issuance of the certificate of occupancy for the seismically isolated structure. Such inspections and observations shall confirm that the conditions allow free and unhindered displacement of the structure to maximum design levels and that all components that cross the isolation interface as installed are able to accommodate the stipulated displacements.
2. The registered design professional responsible for the design of the isolation system shall establish a periodic monitoring, inspection, and maintenance program for such system.
3. Remodeling, repair, or retrofitting at the isolation interface, including that of components that cross the isolation interface, shall be performed under the direction of a registered design professional.

13.2.5.9 Quality control. As part of the quality assurance plan developed in accordance with Sec. 2.2.1, the registered design professional responsible for the structural design shall establish a quality control testing program for isolator units.

13.2.6 Structural system

13.2.6.1 Horizontal distribution of force. A horizontal diaphragm or other structural elements shall provide continuity above the isolation interface and shall have adequate strength and ductility to transmit forces (due to nonuniform ground motion) from one part of the structure to another.

13.2.6.2 Building separations. Minimum separations between the isolated structure and surrounding retaining walls or other fixed obstructions shall not be less than the total maximum displacement.

13.2.6.3 Nonbuilding structures. Nonbuilding structures shall be designed and constructed in accordance with the requirements of Chapter 14 using design displacements and forces calculated in accordance with this chapter.

13.2.7 Elements of structures and nonstructural components. Parts or portions of an isolated structure, permanent nonstructural components and the attachments to them, and the attachments for permanent equipment supported by a structure shall be designed to resist seismic forces and displacements as prescribed in this section and shall satisfy the applicable requirements of Chapter 6.

13.2.7.1 Components below the isolation interface. Elements of seismically isolated structures and nonstructural components, or portions thereof, that are below the isolation interface shall be designed for the forces and displacements indicated in Chapter 4 or Chapter 6, as appropriate.

13.2.7.2 Components crossing the isolation interface. Elements of seismically isolated structures and nonstructural components, or portions thereof, that cross the isolation interface shall be designed to withstand the total maximum displacement.

13.2.7.3 Components at or above the isolation interface. Elements of seismically isolated structures and nonstructural components, or portions thereof, that are at or above the isolation interface shall be designed to resist a total lateral force consistent with the maximum dynamic response of the element or component under consideration.

Exception: Elements of seismically isolated structures and nonstructural components or portions thereof are permitted to be designed for the forces and displacements indicated in Chapter 4 or Chapter 6, as appropriate.

13.3 EQUIVALENT LATERAL FORCE PROCEDURE

Where the equivalent lateral force procedure is used to design seismically isolated structures, the requirements of this section shall apply.

13.3.1 Deformational characteristics of the isolation system. Minimum lateral earthquake design displacement and forces on seismically isolated structures shall be based on the deformational characteristics of the isolation system. The deformational characteristics of the isolation system shall explicitly include the effects of the wind-restraint system if such a system is used to meet the design requirements of these *Provisions*. The deformational characteristics of the isolation system shall be based on properly substantiated tests performed in accordance with Sec. 13.6.

13.3.2 Minimum lateral displacements

13.3.2.1 Design displacement. The isolation system shall be designed and constructed to withstand minimum lateral earthquake displacements that act in the direction of each of the main horizontal axes of the structure and such displacements shall be calculated in accordance with Eq. 13.3-1 as follows:

$$D_D = \left(\frac{g}{4\pi^2} \right) \frac{S_{DI} T_D}{B_D} \quad (13.3-1)$$

where:

- g = acceleration due to gravity.
- S_{DI} = design five-percent-damped spectral acceleration parameter at one second period as determined in Chapter 3.
- T_D = effective period of seismically isolated structure at the design displacement in the direction under consideration, as prescribed by Eq. 13.3-2.
- B_D = numerical coefficient related to the effective damping of the isolation system at the design displacement, β_D , as set forth in Table 13.3-1.

Table 13.3-1 Damping Coefficient, B_D or B_M

Effective Damping, β_D or β_M (Percentage of Critical) ^{a,b}	B_D or B_M Factor
≤ 2	0.8
5	1.0
10	1.2
20	1.5
30	1.7
40	1.9
≥ 50	2.0
^a The damping coefficient shall be based on the effective damping of the isolation system determined in accordance with the requirements of Sec. 13.6.4.2. ^b The damping coefficient shall be based on linear interpolation for effective damping values other than those given.	

13.3.2.2 Effective period at design displacement. The effective period of the isolated structure, T_D , shall be determined using Eq. 13.3-2 as follows:

$$T_D = 2\pi \sqrt{\frac{W}{k_{Dmin} g}} \quad (13.3-2)$$

where:

- W = seismic weight above the isolation interface as defined in Sec. 5.2.1.
- k_{Dmin} = minimum effective stiffness of the isolation system at the design displacement in the horizontal direction under consideration as prescribed by Eq. 13.6-4.
- g = acceleration due to gravity.

13.3.2.3 Maximum displacement. The maximum displacement of the isolation system, D_M , in the most critical direction of horizontal response shall be calculated in accordance with Eq. 13.3-3 as follows:

$$D_M = \left(\frac{g}{4\pi^2} \right) \frac{S_{MI} T_M}{B_M} \quad (13.3-3)$$

where:

- g = acceleration due to gravity.
- S_{MI} = maximum considered five-percent-damped spectral acceleration parameter at 1 sec period as determined in Chapter 3.
- T_M = effective period of seismic-isolated structure at the maximum displacement in the direction under consideration as prescribed by Eq. 13.3-4.
- B_M = numerical coefficient related to the effective damping of the isolation system at the maximum displacement, β_M , as set forth in Table 13.3-1.

13.3.2.4 Effective period at maximum displacement. The effective period of the isolated structure at maximum displacement, T_M , shall be determined using Eq. 13.3-4 as follows:

$$T_M = 2\pi \sqrt{\frac{W}{k_{Mmin} g}} \quad (13.3-4)$$

where:

- W = seismic weight above the isolation interface as defined in Sec. 5.2.1.
- k_{Mmin} = minimum effective stiffness of the isolation system at the maximum displacement in the horizontal direction under consideration as prescribed by Eq. 13.6-6.
- g = acceleration due to gravity.

13.3.2.5 Total displacements. The total design displacement, D_{TD} , and the total maximum displacement, D_{TM} , of elements of the isolation system shall include additional displacement due to inherent and accidental torsion calculated considering the spatial distribution of the lateral stiffness of the isolation system and the most disadvantageous location of eccentric mass.

The total design displacement, D_{TD} , and the total maximum displacement, D_{TM} , of elements of an isolation system with uniform spatial distribution of lateral stiffness shall not be taken less than that prescribed by Eq. 13.3-5 and Eq. 13.3-6, respectively, as follows:

$$D_{TD} = D_D \left[1 + y \left(\frac{12e}{b^2 + d^2} \right) \right] \quad (13.3-5)$$

$$D_{TM} = D_M \left[1 + y \left(\frac{12e}{b^2 + d^2} \right) \right] \quad (13.3-6)$$

where:

D_D = design displacement at the center of rigidity of the isolation system in the direction under consideration as prescribed by Eq. 13.3-1.

D_M = maximum displacement at the center of rigidity of the isolation system in the direction under consideration as prescribed in Eq. 13.3-3.

y = the distance between the center of rigidity of the isolation system and the element of interest measured perpendicular to the direction of seismic loading under consideration.

e = the actual horizontal eccentricity between the center of mass of the structure above the isolation interface and the center of rigidity of the isolation system, plus the accidental eccentricity, taken as 5 percent of the longest plan dimension of the structure perpendicular to the direction of force under consideration.

b = the shortest plan dimension of the structure measured perpendicular to d .

d = the longest plan dimension of the structure.

Exception: The total design displacement, D_{TD} , and the total maximum displacement, D_{TM} , are permitted to be taken less than the values prescribed by Eq. 13.3-5 and Eq. 13.3-6, respectively, but not less than 1.1 times D_D and D_M , respectively, if the isolation system is shown by calculation to be configured to resist torsion accordingly.

13.3.3 Minimum lateral forces

13.3.3.1 Isolation system and structural elements below the isolation system. The isolation system, the foundation, and all structural elements below the isolation system shall be designed and constructed to withstand a minimum lateral force, V_b , using all of the appropriate provisions for a nonisolated structure. V_b shall be determined in accordance with Eq. 13.3-7 as follows:

$$V_b = k_{Dmax} D_D \quad (13.3-7)$$

where:

k_{Dmax} = maximum effective stiffness of the isolation system at the design displacement in the horizontal direction under consideration as prescribed by Eq. 13.6-3.

D_D = design displacement at the center of rigidity of the isolation system in the direction under consideration as prescribed by Eq. 13.3-1.

In all cases, V_b shall not be taken less than the maximum force in the isolation system at any displacement up to and including the design displacement.

13.3.3.2 Structural elements above the isolation system. The structure above the isolation system shall be designed and constructed to withstand a minimum lateral force, V_s , using all of the appropriate provisions for a nonisolated structure. V_s shall be determined in accordance with Eq. 13.3-8 as follows:

$$V_s = \frac{k_{Dmax} D_D}{R_I} \quad (13.3-8)$$

where:

k_{Dmax} = maximum effective stiffness of the isolation system at the design displacement in the horizontal direction under consideration as prescribed by Eq. 13.6-3.

- D_D = design displacement at the center of rigidity of the isolation system in the direction under consideration as prescribed by Eq. 13.3-1.
- R_I = numerical coefficient related to the type of seismic-force-resisting system above the isolation system.

R_I shall be based on the type of seismic-force-resisting system used for the structure above the isolation system and shall be taken as the lesser of 2.0 or 3/8 of the R value given in Table 4.3-1, but need not be taken less than 1.0.

In no case shall V_s be taken less than the following:

1. The lateral force required by Sec. 5.2 for a fixed-base structure of the same weight, W , and a period equal to the isolated period, T_D ;
2. The base shear corresponding to the factored design wind load; and
3. The lateral force required to fully activate the isolation system (e.g., the yield level of a softening system, the ultimate capacity of a sacrificial wind-restraint system, or the break-away friction level of a sliding system) multiplied by 1.5.

13.3.4 Vertical distribution of forces. The total force shall be distributed over the height of the structure above the isolation interface in accordance with Eq. 13.3-9 as follows:

$$F_x = V_s \frac{w_x h_x}{\sum_{i=1}^n w_i h_i} \quad (13.3-9)$$

where:

- V_s = total lateral design force on elements above the isolation system.
- W_x = portion of W that is located at or assigned to Level x .
- h_x = height above the base Level x .
- w_i, w_x = portion of W that is located at or assigned to Level i or Level x , respectively.
- h_i = height, above the base, to Level i .

At each Level x the force, F_x , shall be applied over the area of the structure in accordance with the distribution of mass at the level. Stresses in each structural element shall be determined by applying to an analytical model the lateral forces, F_x , at all levels above the base.

13.3.5 Drift limits. The drift limits specified in this section shall supercede those found in Sec. 4.5.1. The maximum story drift of the structure above the isolation system shall not exceed $0.015h_{sx}$. The drift shall be calculated using Eq. 5.2-15 except that C_d for the isolated structure shall be taken equal to R_I as defined in Sec. 13.3.3.2.

13.4 DYNAMIC PROCEDURES

Where dynamic analysis is used to design seismically isolated structures, the requirements of this section shall apply.

13.4.1 Modeling. The mathematical models of the isolated structure including the isolation system, the seismic-force-resisting system, and other structural elements shall be developed in accordance with Sec. 5.3.1 and this section.

13.4.1.1 Isolation system. The isolation system shall be modeled using deformational characteristics developed and verified by testing in accordance with the requirements of Sec. 13.3.1. The isolation system shall be modeled with sufficient detail to:

1. Account for the spatial distribution of isolator units;

2. Calculate translation, in both horizontal directions, and torsion of the structure above the isolation interface considering the most disadvantageous location of eccentric mass;
3. Assess overturning/uplift forces on individual isolator units; and
4. Account for the effects of vertical load, bilateral load, and the rate of loading if the force-deflection properties of the isolation system are dependent on such attributes.

The total design displacement and total maximum displacement across the isolation system shall be calculated using a model of the isolated structure that incorporates the force-deflection characteristics of nonlinear elements of the isolation system and the seismic-force-resisting system.

13.4.1.2 Isolated structure

The maximum displacement of each floor and design forces and displacements in elements of the seismic-force-resisting system are permitted to be calculated using a linear elastic model of the isolated structure provided that:

1. Stiffness properties assumed for the nonlinear components of the isolation system are based on the maximum effective stiffness of the isolation system, and
2. No elements of the seismic-force-resisting system of the structure above the isolation system are nonlinear.

Seismic-force-resisting systems with nonlinear elements include, but are not limited to, irregular structural systems designed for a lateral force less than 100 percent of V_s and regular structural systems designed for a lateral force less than 80 percent of V_s , where V_s is determined in accordance with Sec. 13.3.3.2.

13.4.2 Description of procedures. The response spectrum procedure, linear response history procedure, and nonlinear response history procedure shall be performed in accordance with Sec. 5.3, 5.4, and 5.5, respectively, and the requirements of this section.

13.4.2.1 Input earthquake. The design earthquake shall be used to calculate the total design displacement of the isolation system and the lateral forces and displacements of the isolated structure. The maximum considered earthquake shall be used to calculate the total maximum displacement of the isolation system.

13.4.2.2 Response spectrum procedure. Response spectrum analysis shall be performed using a modal damping value for the fundamental mode in the direction of interest not greater than the effective damping of the isolation system or 30 percent of critical, whichever is less. Modal damping values for higher modes shall be selected consistent with those that would be appropriate for response spectrum analysis of the structure above the isolation system assuming a fixed base.

Response spectrum analysis used to determine the total design displacement and the total maximum displacement shall include simultaneous excitation of the model by 100 percent of the ground motion in the critical direction and 30 percent of the ground motion in the perpendicular, horizontal direction. The maximum displacement of the isolation system shall be calculated as the vectorial sum of the two orthogonal displacements.

The design shear at any story shall not be less than the story shear resulting from application of the story forces calculated using Eq. 13.3-9 and a value of V_s equal to the base shear obtained from the response-spectrum analysis in the direction of interest.

13.4.2.3 Response history procedure. Where a response history procedure is performed, a suite of not fewer than three appropriate ground motions shall be used in the analysis and the ground motions shall be selected and scaled in accordance with Sec. 13.2.3.2. Each pair of ground motion components shall be applied to the model considering the most disadvantageous location of eccentric mass. The

maximum displacement of the isolation system shall be calculated from the vectorial sum of the two orthogonal displacement components at each time step.

For each ground motion analyzed, the parameters of interest shall be calculated. If at least seven ground motions are analyzed, the average value of the response parameter of interest shall be permitted to be used for design. If fewer than seven ground motions are analyzed, the maximum value of the response parameter of interest shall be used for design.

13.4.3 Minimum lateral displacements and forces

13.4.3.1 Isolation system and structural elements below the isolation system. The isolation system, the foundation, and all structural elements below the isolation system shall be designed and constructed using all of the appropriate requirements for a nonisolated structure and the forces obtained from the dynamic analysis without reduction, but the design lateral force shall not be taken less than 90 percent of V_b determined in accordance with Sec. 13.3.3.1.

The total design displacement of the isolation system shall be taken as not less than 90 percent of D_{TD} . The total maximum displacement of the isolation system shall be taken as not less than 80 percent of D_{TM} . These limits shall be evaluated using values of D_{TD} and D_{TM} determined in accordance with Sec. 13.3.2.5 except that D'_D and D'_M , as calculated using Eq. 13.4-1 and 13.4-2, shall be permitted to be used in lieu of D_D and D_M , respectively.

$$D'_D = \frac{D_D}{\sqrt{1 + \left(\frac{T}{T_D}\right)^2}} \quad (13.4-1)$$

$$D'_M = \frac{D_M}{\sqrt{1 + \left(\frac{T}{T_M}\right)^2}} \quad (13.4-2)$$

where:

- D_D = design displacement at the center of rigidity of the isolation system in the direction under consideration, determined in accordance with Sec. 13.3.2.1.
- D_M = maximum displacement at the center of rigidity of the isolation system in the direction under consideration, determined in accordance with Sec. 13.3.2.3.
- T = elastic, fixed-base period of the structure above the isolation system, determined in accordance with Sec. 5.2.2.
- T_D = effective period of the seismically isolated structure at the design displacement in the direction under consideration, determined in accordance with Sec. 13.3.2.2.
- T_M = effective period of the seismically isolated structure at the maximum displacement in the direction under consideration, determined in accordance with Sec. 13.3.2.4.

13.4.3.2 Structural elements above the isolation system. Subject to the procedure-specific limits of this section, structural elements above the isolation system shall be designed using the appropriate provisions for a nonisolated structure and the forces obtained from the dynamic analysis divided by R_I , where R_I is determined in accordance with Sec. 13.3.3.2.

Where the response spectrum procedure is used and the structure is regular in configuration, the design lateral force on the structure above the isolation system shall be taken as not less than 80 percent of V_s as determined in accordance with Sec. 13.3.3.2. Where the response spectrum procedure is used and the

structure is irregular in configuration, the design lateral force on the structure above the isolation system shall be taken as not less than 100 percent of V_s as determined in accordance with Sec. 13.3.3.2.

Where the response history procedure is used and the structure is regular in configuration, the design lateral force on the structure above the isolation system shall be taken as not less than 60 percent of V_s as determined in accordance with Sec. 13.3.3.2. Where the response history procedure is used and the structure is irregular in configuration, the design lateral force on the structure above the isolation system shall be taken as not less than 80 percent of V_s as determined in accordance with Sec. 13.3.3.2.

13.4.3.3 Scaling of results. Where the design lateral force on structural elements, determined using either the response spectrum or response history procedure, is less than the minimum level required by Sec. 13.4.3.1 and 13.4.3.2, all response parameters, including member forces and moments, shall be adjusted proportionally upward.

13.4.4 Drift limits. The drift limits specified in this section shall supercede those found in Sec. 4.5.1. The maximum story drift of the structure above the isolation system corresponding to the design lateral force, including displacement due to vertical deformation of the isolation system, shall not exceed $0.015h_{sx}$ where the response spectrum procedure is used, or $0.020h_{sx}$ where the response history procedure is used.

Drift shall be calculated using Eq. 5.3-8 with C_d for the isolated structure taken equal to R_f as defined in Sec. 13.3.3.2.

The secondary effects of the maximum considered earthquake lateral displacement, Δ , of the structure above the isolation system combined with gravity forces shall be investigated if the story drift ratio exceeds $0.010/R_f$.

13.5 DESIGN REVIEW

A design review of the isolation system and related test programs shall be performed by an independent team of registered design professionals in the appropriate disciplines and others experienced in seismic analysis methods and the theory and application of seismic isolation. Isolation system design review shall include, but need not be limited to, the following:

1. Review of site-specific seismic criteria including the development of site-specific spectra and ground motion time histories and all other design criteria developed specifically for the project;
2. Review of the preliminary design including the determination of the total design displacement of the isolation system and the lateral force design level;
3. Overview and observation of prototype testing, performed in accordance with Sec. 13.6;
4. Review of the final design of the entire structural system and all supporting analyses; and
5. Review of the isolation system quality control testing program developed in accordance with Sec. 13.2.5.9.

13.6 TESTING

The deformation characteristics and damping values of the isolation system used in the analysis and design of seismically isolated structures shall be based on tests of a selected sample of the components prior to construction as described in this section.

The isolation system components to be tested shall include the wind-restraint system if such a system is used in the design.

The tests specified in this section are for establishing and validating the design properties of the isolation system and shall not be considered as satisfying the manufacturing quality control tests of Sec. 13.2.5.9.

13.6.1 Prototype tests. Prototype tests shall be performed separately on two full-size specimens (or sets of specimens, as appropriate) for each predominant type and size of isolator unit of the isolation system. The test specimens shall include the wind restraint system as well as individual isolator units if such system is used in the design. Specimens tested shall not be used for construction unless accepted by the registered design professional.

13.6.1.1 Record. For each cycle of tests, the force-deflection behavior of the test specimen shall be recorded.

13.6.1.2 Sequence and cycles. For all isolator units of a common type and size, the following sequence of tests shall be performed for the prescribed number of cycles while the test specimen is subjected to a vertical load equal to the average dead load plus one-half the average live load:

1. Twenty fully reversed cycles of loading at a lateral force corresponding to the wind design force;
2. Three fully reversed cycles of loading at each of the following increments of displacement: $0.25D_D$, $0.5D_D$, $1.0D_D$, and $1.0D_M$;
3. Three fully reversed cycles of loading at the total maximum displacement, D_{TM} ; and
4. $30S_{D1}/B_D S_{DS}$ but not less than ten, fully reversed cycles of loading at the total design displacement, D_{TD} .

If an isolator unit is also a vertical-load-carrying element, then Item 2 of the sequence of cyclic tests specified above shall be performed for two additional vertical load cases: 1) $1.2D + 0.5L + |E|$ and 2) $0.8D - |E|$, where each vertical load case is based on the average downward force on all isolator units of a common type and size. The dead load, D , and the live load, L , are defined in Sec. 13.1.2. The effect of seismic load, E , shall be determined in accordance with Sec. 4.2.2.1 and the vertical loads that result from application of horizontal seismic forces, Q_E , shall be based on peak response corresponding to the test displacement being evaluated.

13.6.1.3 Units dependent on loading rates. If the force-deflection properties of the isolator units are dependent on the rate of loading, then each set of tests specified in Sec. 13.6.1.2 shall be performed dynamically at a frequency equal to the inverse of the effective period of the isolated structure, T_D . The force-deflection properties of an isolator unit shall be considered to be dependent on the rate of loading if the measured property (effective stiffness or effective damping) at the design displacement where tested at any frequency in the range of 0.1 to 2.0 times the inverse of T_D is different from the property where tested at a frequency equal to the inverse of T_D by more than 15 percent.

If reduced-scale prototype specimens are used to quantify rate-dependent properties of isolators, the reduced-scale prototype specimens shall be of the same type and material and be manufactured with the same processes and quality as full-scale prototypes and shall be tested at a frequency that represents full-scale prototype loading rates.

13.6.1.4 Units dependent on bilateral load. If the force-deflection properties of the isolator units are dependent on bilateral load, the tests specified in Sec. 13.6.1.2 and 13.6.1.3 shall be augmented to include bilateral load at the following increments of the total design displacement, D_{TD} : 0.25 and 1.0, 0.50 and 1.0, 0.75 and 1.0, and 1.0 and 1.0. The force-deflection properties of an isolator unit shall be considered to be dependent on bilateral load if the effective stiffness where subjected to bilateral loading is different from the effective stiffness where subjected to unilateral loading by more than 15 percent.

If reduced-scale prototype specimens are used to quantify bilateral-load-dependent properties, then such specimens shall be of the same type and material and manufactured with the same processes and quality as full-scale prototypes.

13.6.1.5 Maximum and minimum vertical load. In addition to the cyclic testing requirements of Sec. 13.6.1.2, isolator units that are vertical-load-carrying elements shall be statically tested by subjecting them to the total maximum displacement while under the maximum and minimum vertical

load. In these tests, the maximum vertical load shall be taken as the maximum effect of $1.2D + 1.0L + |E|$ and the minimum vertical load shall be taken as the minimum effect of $0.8D - |E|$ for any one isolator of a common type and size. The dead load, D , and the live load, L , are defined in Sec. 13.1.2. The effect of seismic load, E , shall be determined in accordance with Sec. 4.2.2.1 except that S_{MS} shall be used in place of S_{DS} and the vertical loads that result from application of horizontal seismic forces, Q_E , shall be based on peak response due to the maximum considered earthquake.

13.6.1.6 Sacrificial wind-restraint systems. If a sacrificial wind-restraint system is to be utilized, the ultimate capacity shall be established by test.

13.6.1.7 Testing similar units. The prototype tests are not required if an isolator unit is of similar dimensional characteristics and of the same type and material as a prototype isolator unit that has been previously tested using the specified sequence of tests.

13.6.2 Determination of force-deflection characteristics. The force-deflection characteristics of the isolation system shall be based on the cyclic load tests of isolator prototypes specified in Sec. 13.6.1.

As required, the effective stiffness of an isolator unit, k_{eff} , shall be calculated for each cycle of loading by Eq. 13.6-1 as follows:

$$k_{eff} = \frac{|F^+| + |F^-|}{|\Delta^+| + |\Delta^-|} \quad (13.6-1)$$

where F^+ and F^- are the positive and negative forces at Δ^+ and Δ^- , respectively.

As required, the effective damping, β_{eff} , of an isolator unit shall be calculated for each cycle of loading by Eq. 13.6-2 as follows:

$$\beta_{eff} = \frac{2}{\pi} \left[\frac{E_{loop}}{k_{eff} (|\Delta^+| + |\Delta^-|)^2} \right] \quad (13.6-2)$$

where the energy dissipated per cycle of loading, E_{loop} , and the effective stiffness, k_{eff} , shall be based on peak test displacements of Δ^+ and Δ^- .

13.6.3 Test specimen adequacy. The performance of the test specimens shall be deemed adequate if the following conditions are satisfied:

1. The force-deflection plots for all tests specified in Sec. 13.6.1 have a positive incremental force carrying capacity. For each increment of test displacement specified in Item 2 of Sec. 13.6.1.2 and for each vertical load case specified in Sec. 13.6.1.2,
 - a. For each test specimen, the difference between the effective stiffness at each of the three cycles of test and the average value of effective stiffness is no greater than 15 percent; and
 - b. For each cycle of test, the difference between effective stiffness of the two test specimens of a common type and size of the isolator unit and the average effective stiffness is no greater than 15 percent.
2. For each specimen there is no greater than a 20 percent change in the initial effective stiffness over the cycles of test specified in Item 4 of Sec. 13.6.1.2;
3. For each specimen there is no greater than a 20 percent decrease in the initial effective damping over the cycles of test specified in Item 4 of Sec. 13.6.1.2; and
4. All specimens of vertical-load-carrying elements of the isolation system remain stable when tested in accordance with Sec. 13.6.1.5.

13.6.4 Design properties of the isolation system

13.6.4.1 Maximum and minimum effective stiffness. At the design displacement, the maximum and minimum effective stiffness of the entire isolated system, k_{Dmax} and k_{Dmin} , shall be based on the cyclic tests of individual isolator units in accordance with Item 2 of Sec. 13.6.1.2 and calculated using Eq. 13.6-3 and 13.6-4 as follows:

$$k_{Dmax} = \frac{\sum |F_D^+|_{max} + \sum |F_D^-|_{max}}{2D_D} \quad (13.6-3)$$

$$k_{Dmin} = \frac{\sum |F_D^+|_{min} + \sum |F_D^-|_{min}}{2D_D} \quad (13.6-4)$$

At the maximum displacement, the maximum and minimum effective stiffness of the entire isolation system, k_{Mmax} and k_{Mmin} , shall be based on the cyclic tests of individual isolator units in accordance with Item 2 of Sec. 13.6.1.2 and calculated using Eq. 13.6-5 and 13.6-6 as follows:

$$k_{Mmax} = \frac{\sum |F_M^+|_{max} + \sum |F_M^-|_{max}}{2D_M} \quad (13.6-5)$$

$$k_{Mmin} = \frac{\sum |F_M^+|_{min} + \sum |F_M^-|_{min}}{2D_M} \quad (13.6-6)$$

The maximum effective stiffness of the isolation system, k_{Dmax} (or k_{Mmax}), shall be based on forces from the cycle of prototype testing at a test displacement equal to D_D (or D_M) that produces the largest value of effective stiffness. Minimum effective stiffness of the isolation system, k_{Dmin} (or k_{Mmin}), shall be based on forces from the cycle of prototype testing at a test displacement equal to D_D (or D_M) that produces the smallest value of effective stiffness.

For isolator units that are found by the tests of Sec. 13.6.1.2, 13.6.1.3 and 13.6.1.4 to have force-deflection characteristics that vary with vertical load, rate of loading, or bilateral load, respectively, the values of k_{Dmax} and k_{Mmax} shall be increased and the values of k_{Dmin} and k_{Mmin} shall be decreased to bound the effects of measured variation in effective stiffness.

13.6.4.2 Effective damping. At the design displacement, the effective damping of the entire isolation system, β_D , shall be based on the cyclic tests of individual isolator units in accordance with Item 2 of Sec. 13.6.1.2 and calculated using Eq. 13.6-7 as follows:

$$\beta_D = \frac{1}{2\pi} \left(\frac{\sum E_D}{k_{Dmax} D_D^2} \right) \quad (13.6-7)$$

In Eq. 13.6-7, the total energy dissipated per cycle of design displacement response, $\sum E_D$, shall be taken as the sum of the energy dissipated per cycle in all isolator units measured at a test displacement equal to D_D , and shall be based on forces and deflections from the cycle of prototype testing that produces the smallest value of effective damping.

At the maximum displacement, the effective damping of the entire isolation system, β_M , shall be based on the cyclic tests of individual isolator units in accordance with Item 2 of Sec. 13.6.1.2 and calculated using Eq. 13.6-8 as follows:

$$\beta_M = \frac{1}{2\pi} \left(\frac{\sum E_M}{k_{Mmax} D_M^2} \right) \quad (13.6-8)$$

In Eq. 13.6-8, the total energy dissipated per cycle of maximum displacement response, ΣE_M , shall be taken as the sum of the energy dissipated per cycle in all isolator units measured at a test displacement equal to D_M , and shall be based on forces and deflections from the cycle of prototype testing that produces the smallest value of effective damping.

Chapter 14

NONBUILDING STRUCTURE DESIGN REQUIREMENTS

14.1 GENERAL

14.1.1 Scope. Nonbuilding structures considered by these *Provisions* include all self-supporting structures which carry gravity loads, with the exception of buildings, vehicular and railroad bridges, electric power substation equipment, overhead power line support structures, buried pipelines, conduits and tunnels, lifeline systems, nuclear power generation plants, offshore platforms, and dams. Nonbuilding structures supported by the earth or by other structures shall be designed and detailed in accordance with these *Provisions* as modified by this chapter. Nonbuilding structures for which this chapter does not provide explicit direction shall be designed in accordance with engineering practices that are approved by the authority having jurisdiction and are applicable to the specific type of nonbuilding structure.

Architectural, mechanical, and electrical components supported by nonbuilding structures within the scope of chapter 14, and their supports and attachments, shall be designed in accordance with Chapter 6 of these *Provisions*.

Exception: Storage racks, cooling towers, and storage tanks shall be designed in accordance with Chapter 14 of these *Provisions*.

14.1.2 References

14.1.2.1 Adopted references. The following references form a part of these *Provisions* to be used for the applications indicated in Table 14.1-1 as specified in this chapter.

ACI 313	<i>Standard Practice for the Design and Construction of Concrete Silos and Stacking Tubes for Storing Granular Materials</i> , American Concrete Institute, 1997.
ACI 350.3	<i>Seismic Design of Liquid-Containing Concrete Structures</i> , American Concrete Institute, 2001.
API 620	<i>Design and Construction of Large, Welded, Low Pressure Storage Tanks</i> , American Petroleum Institute, 2002.
API 650	<i>Welded Steel Tanks For Oil Storage</i> , American Petroleum Institute, 1998.
ASME BPV	<i>Boiler And Pressure Vessel Code</i> , American Society of Mechanical Engineers, including addenda through 2003.
AWWA D100	<i>Welded Steel Tanks for Water Storage</i> , American Water Works Association, 1996.
AWWA D103	<i>Factory-Coated Bolted Steel Tanks for Water Storage</i> , American Water Works Association, 1997.
AWWA D110	<i>Wire- and Strand-Wound Circular Prestressed Concrete Water Tanks</i> , American Water Works Association, 1995.
AWWA D115	<i>Circular Prestressed Concrete Tanks with Circumferential Tendons</i> , American Water Works Association, 1995.
RMI	<i>Specification for the Design, Testing, and Utilization of Industrial Steel Storage Racks</i> , Rack Manufacturers Institute, 1997 (Reaffirmed 2002).

NCEL R-939 Ebeling, R. M., and Morrison, E. E., *The Seismic Design of Waterfront Retaining Structures*, Naval Civil Engineering Laboratory, 1993.

Table 14.1-1 Adopted References

Application	Reference
Steel storage racks	RMI
Welded steel tanks for water storage	AWWA D100
Welded steel tanks for petroleum and petrochemical storage	API 650, API 620
Bolted steel tanks for water storage	AWWA D103
Piers and Wharves	
Concrete tanks for water storage	AWWA D115, AWWA D110, ACI 350.3
Pressure vessels	ASME BPV
Concrete silos and stacking tubes	ACI 313

14.1.2.2 Other references

ACI 371R *Guide for the Analysis, Design, and Construction of Concrete Pedestal Water Towers*, American Concrete Institute, 1998.

API 653 *Tank Inspection, Repair, Alteration, and Reconstruction*, American Petroleum Institute, 2001.

API Spec 12B *Bolted Tanks for Storage of Production Liquids*, American Petroleum Institute, 1995 (Reaffirmed 2000).

14.1.3 Definitions

Attachments: See Sec. 6.1.3.

Base: See Sec. 4.1.3.

Base shear: See Sec. 4.1.3.

Building: See Sec. 4.1.3.

Component: See Sec. 1.1.4.

Container: A large-scale independent component used as a receptacle or a vessel to accommodate plants, refuse, or similar uses.

Dead load: See Sec. 4.1.3.

Diaphragm: See Sec. 4.1.3.

Flexible component: See Sec. 6.1.3.

Flexible equipment connections: Those connections between equipment components that permit rotational and/or transitional movement without degradation of performance. Examples included universal joints, bellows, expansion joints, and flexible metal hose.

Live load: See Sec. 4.1.3.

Maximum considered earthquake ground motion: See Sec. 3.1.3.

Nonbuilding structure: A structure, other than a building, constructed of a type included in Chapter 14 and within the limits of Sec. 14.1.1.

Nonbuilding structure similar to building: A nonbuilding structure that is designed and constructed in a manner similar to buildings, with a basic seismic-force-resisting-system conforming to one of the types indicated in Table 4.3-1, usually with diaphragms or other elements to transfer lateral forces to the vertical seismic force resisting system.

Occupancy importance factor: See Sec. 1.1.4.

P-delta effect: See Sec. 5.1.2.

Plain masonry: See Sec. 11.1.3.

Reinforced masonry: See Sec. 11.1.3.

Rigid component: See Sec. 6.1.3.

Seismic Design Category: See Sec. 1.1.4.

Seismic force-resisting system: See Sec. 1.1.4.

Seismic forces: See Sec. 1.1.4.

Seismic Use Group: A classification assigned to the structure based on its use as defined in Sec. 1.3.

Storage racks: Industrial pallet racks, moveable shelf racks, and stacker racks made of cold-formed and hot-rolled structural members. Other types of racks such as drive-in and drive-through racks, cantilever racks, portable racks, or racks made of materials other than steel are not included.

Structure: See Sec. 1.1.4.

Supports: See Sec. 6.1.3.

14.1.4 Notation.

A_g See Sec. 7.1.4.

B Inside length of a rectangular tank, perpendicular to the direction of the earthquake force being investigated.

a_p See Sec. 6.1.4.

C_d See Sec. 4.1.4.

C_v A coefficient defined in 14.4.7.1(3) [Eq. (14.4-2)].

D See Sec. 4.1.4.

D_i Inside diameter of tank or vessel.

E See Sec. 4.1.4.

E_t Modulus of elasticity of tank or vessel wall material.

F_h Total unbalanced lateral dynamic earth and groundwater pressure acting on the outer wall of the tank or vessel.

F_y The yield stress.

g See Sec. 13.1.3.

H The height of liquid in a tank.

H_L Design liquid height inside tank or vessel.

H_w Height of tank or vessel wall (shell).

h Depth of tank wall embedment.

h_i, h_x The height above the base Level i or x , respectively.

I See Sec. 1.1.5.

I_p See Sec. 6.1.4.

k See Sec. 5.1.3.

k_h	Horizontal ground acceleration (as used in the design of buried tanks and vessels).
L	Inside length of a rectangular tank, parallel to the direction of the earthquake force being investigated.
M	Overturning moment.
N_h	Hydrodynamic hoop force in the wall of a cylindrical tank or vessel
R	See Sec. 4.1.4.
R_p	See Sec. 6.1.4.
S_a	See Sec. 3.1.4.
S_{ac}	The design spectral response acceleration for a convective mode.
S_{ai}	The design spectral response acceleration for an impulsive mode.
S_{DI}	See Sec. 3.1.4.
S_{DS}	See Sec. 3.1.4.
T	See Sec. 4.1.4.
T_0	See Sec. 3.1.4.
T_c	The natural period of the first convective mode.
T_i	The natural period of the first impulsive mode.
T_S	See Sec. 3.1.4.
T_v	The natural period of vertical vibration of the liquid and tank structural system.
t_w	Thickness of tank or vessel wall.
V	See Sec. 5.1.3.
V_c	The total convective shear at the base of the structure in the direction of interest.
V_i	The total impulsive shear at the base of the structure in the direction of interest.
V_{max}	The peak local tangential shear per unit length as determined by Eq. 14.4-10.
\tilde{V}	See Sec. 5.1.3.
W	See Sec. 1.1.5.
W_c	The convective component of seismic weight.
W_i	The impulsive component of seismic weight.
W_L	Weight of the stored liquid.
W_p	See Sec. 6.1.4.
W_r	Weight of the tank roof.
W_w	Weight of the tank or vessel wall (shell).
y	Distance from base of the tank to level being investigated.
γ_L	Unit weight of stored liquid.
δ_s	The height of a sloshing wave.
δ_x	See Sec. 4.1.4.
δ_{xe}	The deflection of Level x at the center of the mass at and above Level x determined by an elastic analysis.

ρ See Sec. 4.1.4.

Ω_0 See Sec. 4.1.4.

14.1.5 Nonbuilding structures supported by other structures. If a nonbuilding structure is supported above the base by another structure and the weight of the nonbuilding structure is not more than 25 percent of the seismic weight, W , as defined in Sec. 5.2.1, the design seismic forces for the supported nonbuilding structure shall be determined in accordance with the requirements of Chapter 6.

Exception: Storage racks, cooling towers, and storage tanks shall be designed in accordance with Chapter 14 of these *Provisions*.

If the weight of a supported nonbuilding structure is more than 25 percent of the seismic weight, W , as defined in Sec. 5.2.1, the design seismic forces shall be determined based on an analysis of the combined system (comprising the nonbuilding structure and supporting structure). For supported nonbuilding structures that have rigid component dynamic characteristics, the R factor for the supporting structural system shall be used for the combined system. For supported nonbuilding structures that have flexible component dynamic characteristics, the R factor for the combined system shall not be greater than 3. The supported nonbuilding structure, and its supports and attachments, shall be designed for the forces determined from the analysis of the combined system.

14.2 GENERAL DESIGN REQUIREMENTS

14.2.1 Seismic Use Groups and importance factors. The Seismic Use Group and importance factor, I , for nonbuilding structures shall be determined based on the function of the structure and the relative hazard of its contents. The value of I shall be the largest of the values determined using approved standards, Table 14.2-1, and other provisions in this chapter.

Table 14.2-1 Seismic Use Groups and Importance Factors for Nonbuilding Structures

Seismic Use Group	I	II	III
Function ^a	F-I	F-II	F-III
Hazard ^b	H-I	H-II	H-III
Importance Factor	I = 1.0	I = 1.25	I = 1.5

^a Function shall be classified as follows:
 F-I Nonbuilding structures not classified as F-III.
 F-II Not applicable for nonbuilding structures.
 F-III Nonbuilding structures that are required for post-earthquake recovery or as emergency back-up facilities for Seismic Use Group III structures.

^b Hazard shall be classified as follows:
 H-I Nonbuilding structures that are not assigned to H-II or H-III.
 H-II Nonbuilding structures that have a substantial public hazard due to contents or use as determined by the authority having jurisdiction.
 H-III Nonbuilding structures containing sufficient quantities of toxic or explosive substance deemed to be hazardous to the public as determined by the authority having jurisdiction.

14.2.2 Ground motion. Where a site-specific study is required by an approved standard or the authority having jurisdiction, the design ground motion shall be determined in accordance with Sec. 3.4.

If a longer recurrence interval is defined in the adopted reference or other approved standard for a nonbuilding structure (such as LNG tanks), the recurrence interval required in the standard shall be used.

14.2.3 Design basis. Nonbuilding structures shall be designed to have sufficient stiffness, strength, and ductility to resist the effects of seismic ground motions. Where adopted references or other approved standards establish specific seismic design criteria for nonbuilding structures, the design shall satisfy those

criteria as amended in this chapter. When adopted references or other approved standards are not available, nonbuilding structures shall be designed in accordance with these *Provisions*.

Unless otherwise noted in this chapter, the effects on the nonbuilding structure due to gravity loads and seismic forces shall be combined in accordance with the factored load combinations as presented in ASCE 7 except that the seismic loads, E , shall be as defined in Sec. 4.2.2.1.

Where specifically required by these *Provisions*, the design seismic force on nonbuilding structure components sensitive to the effects of structural overstrength shall be as defined in Sec. 4.2.2.2. The system overstrength factor, Ω_o , shall be taken from Table 14.2-2.

14.2.4 Seismic-force-resisting system selection and limitations. The basic seismic-force-resisting system shall be selected as follows:

1. For nonbuilding structures similar to buildings, a system shall be selected from among the types indicated in Table 14.2-2 subject to the system limitations and height limits, based on Seismic Design Category, indicated in the table. The appropriate values of R , Ω_o , and C_d indicated in Table 14.2-2 shall be used in determining the base shear, element design forces, and design story drift as indicated in these *Provisions*. Design and detailing requirements shall comply with the sections referenced in table 14.2-2.
2. For nonbuilding structures not similar to buildings, a system shall be selected from among the types indicated in Table 14.2-3 subject to the system limitations and height limits, based on Seismic design Category indicated in the table. The appropriate values of R , Ω_o , and C_d indicated in Table 4.3-1 shall be used in determining the base shear, element design forces, and design story drift as indicated in these *Provisions*. Design and detailing requirements shall comply with the sections referenced in Table 14.2-3.
3. Where neither Table 14.2-2 nor Table 14.2-3 contains an appropriate entry, applicable strength and other design criteria shall be obtained from an adopted reference that is applicable to the specific type of nonbuilding structure. Design and detailing requirements shall comply with the adopted reference.

Where an approved standard provides a basis for the earthquake-resistant design of a particular type of nonbuilding structure, such a standard may be used subject to the following limitations:

1. The design ground motion shall be determined in accordance with Chapter 3.
2. The values for total lateral force and total base overturning moment used in design shall not be less than 80 percent of the base shear and overturning moment that would be obtained using Chapter 5 of these *Provisions*.
3. Where the approved standard defines acceptance criteria in terms of allowable stresses (as opposed to strengths), the design seismic forces shall be obtained from the *Provisions* and reduced by a factor of 1.4 for use with allowable stresses and allowable stress increases used in the approved standard are permitted.

Table 14.2-2 Design Coefficients and Factors for Nonbuilding Structures Similar to Buildings

Nonbuilding Structure Type	Required Detailing Provisions	R	Ω_0	C_d	System Limitations and Height Limits (ft) by Seismic Design Category ^a				
					B	C	D	E	F
Steel Storage Racks	Sec. 14.3.5	4	2	3.5	NL	NL	NL	NL	NL
Building frame systems:									
Special steel concentrically braced frames	AISC Seismic, Part I, Sec. 13	6	2	5	NL	NL	160	160	100
Ordinary steel concentrically braced frame									
With Building Structure Height Limits	AISC Seismic, Part I, Sec. 14	5	2	4.5	NL	NL	35 ^b	35 ^b	NP ^b
With Non-building Structure Height Limits	AISC Seismic, Part I, Sec. 14	3.5	2	3.5	NL	NL	160	160	100
Moment resisting frame systems:									
Special steel moment frames	AISC Seismic, Part I, Sec. 9	8	3	5.5	NL	NL	NL	NL	NL
Special reinforced concrete moment frames	Sec. 9.2.2.2 & ACI 318, Chapter 21	8	3	5.5	NL	NL	NL	NL	NL
Intermediate steel moment frames									
With Building Structure Height Limits	AISC Seismic, Part I, Sec. 10	4.5	3	4	NL	NL	35 ^{c,d}	NP ^{c,d}	NP ^{c,d}
With Non-building Structure Height Limits	AISC Seismic, Part I, Sec. 10	2.5	2	2.5	NL	NL	160	160	100
Intermediate reinforced concrete moment frames									
With Building Structure Height Limits	9.2.2.3 and ACI 318, Chapter 21	5	3	4.5	NL	NL	NP	NP	NP
With Non-building Structure Height Limits	9.2.2.3 and ACI 318, Chapter 21	3.5	2.5	3	NL	NL	50	50	50
Ordinary moment frames of steel									
With Building Structure Height Limits	AISC Seismic, Part I, Sec. 10	3.5	3	3	NL	NL	NP ^{c,d}	NP ^{c,d}	NP ^{c,d}
With Non-building Structure Height Limits	AISC Seismic, Part I, Sec. 10	2.5	2	2.5	NL	NL	100	100	NP ^c
Ordinary reinforced concrete moment frames	Sec. 9.3.1 & ACI 318, Chapter 21	3	3	2.5	NL	NP	NP	NP	NP

^a NL = no limit and NP = not permitted. If using metric units, 50 ft approximately equals 15 m. Heights are measured from the base of the structure as defined in Sec. 14 1.3.

^b Steel ordinary braced frames are permitted in pipe racks up to 65 feet (20 m).

^c Steel ordinary moment frames and intermediate moment frames are permitted in pipe racks up to a height of 65 feet (20 m) where the moment joints of field connections are constructed of bolted end plates.

^d Steel ordinary moment frames and intermediate moment frames are permitted in pipe racks up to a height of 35 ft (11 m).

Table 14.2-3 Design Coefficients and Factors for Nonbuilding Structures NOT Similar to Buildings

Nonbuilding Structure Type	Required Detailing Provisions	R	Ω_0	C_d	System Limitations and Height Limits (ft) by Seismic Design Category ^a				
					B	C	D	E	F
Elevated tanks, vessels, bins, or hoppers: On symmetrically braced legs On unbraced or asymmetrically braced legs Single pedestal or skirt supported - welded steel - prestressed or reinforced concrete ^c	Sec. 14.4.7.9	3	2 ^b	2.5	NL	NL	NL	160	100
		2	2 ^b	2.5	NL	NL	NL	100	60
		3	2 ^b	2	NL	NL	NL	NL	NL
		3 ^b	2 ^b	2	NL	NL	NL	NL	NL
Horizontal, saddle supported welded steel vessels	Sec. 14.4.7.13	3	2 ^b	2.5	NL	NL	NL	NL	NL
Tanks or vessels supported on structural towers similar to buildings	Sec. 14.3.2	3	2	2	NL	NL	NL	NL	NL
Flat bottom, ground supported tanks, or vessels: Steel or fiber-reinforced plastic: Mechanically anchored Self-anchored Reinforced or prestressed concrete: with reinforced nonsliding base with anchored flexible base with unanchored and unconstrained flexible base Other material	Sec. 14.4.7	3	2 ^b	2.5	NL	NL	NL	NL	NL
		2.5	2 ^b	2	NL	NL	NL	NL	NL
		2	2 ^b	2	NL	NL	NL	NL	NL
		3.25	2 ^b	2	NL	NL	NL	NL	NL
		1.5	1.5 ^b	1.5	NL	NL	NL	NL	NL
1.5	1.5 ^b	1.5	NL	NL	NL	NL	NL	NL	
Cast-in-place concrete silos, stacks, and chimneys having walls continuous to the foundation	Sec. 14.4.3	3	1.75	3	NL	NL	NL	NL	NL
Reinforced masonry structures not similar to buildings	Chapter 11	3	2	2.5	NL	NL	NL	50	50
Plain masonry structures not similar to buildings	Chapter 11	1.25	2	1.5	NL	NL	50	50	50
Steel and reinforced concrete distributed mass cantilever structures not covered herein (including stacks, chimneys, silos, and skirt-supported vertical vessels that are not similar to buildings)	Adopted References	3	2	2.5	NL	NL	NL	NL	NL
Trussed towers (freestanding or guyed), guyed stacks and chimneys	Adopted References	3	2	2.5	NL	NL	NL	NL	NL
Cooling towers: Concrete or steel Wood frames	Adopted References	3.5	1.75	3	NL	NL	NL	NL	NL
		3.5	3	3	NL	NL	NL	50	50
Inverted pendulum type structures (except elevated tanks, vessels, bins and hoppers)	Adopted References	2	2	2	NL	NL	NL	NL	NL
Signs and billboards	Adopted References	3.5	1.75	3	NL	NL	NL	NL	NL
Self-supporting structures that are not similar to buildings and are not covered above or by approved standards	Adopted References	1.25	2	2.5	NL	NL	50	50	50

^a NL = no limit and NP = not permitted. If using metric units, 50 ft approximately equals 15 m. Heights are measured from the base of the structure as defined in Sec. 14.1.3.

^b In the case of tanks and vessels, the overstrength factors, Ω_0 , tabulated above apply only to connections, anchorages and other seismic-force-resisting tank *components* or *elements*, which shall be designed in accordance with the provisions of Sec. 14.4.7.2 and 14.4.7.4 (except that anchor bolts or anchor cables that are designed to yield shall be permitted to be designed using an overstrength value, $\Omega_0 = 1.0$). The overstrength provisions of Sec. 4.2.2.2 and the, Ω_0 , values tabulated above, do not apply to the design of walls, including interior walls of tanks and vessels.

^c Detailing in accordance with Sec. 9.2.1.6 of these *Provisions* for special reinforced concrete shear walls is required, or *R* shall be taken as 2.

14.2.5 Structural analysis procedure selection. Structural analysis procedures for nonbuilding structures that are similar to buildings shall be selected in accordance with Sec. 4.4.1 of these *Provisions*.

Nonbuilding structures that are not similar to buildings shall be analyzed by using either the equivalent lateral force procedure in accordance with Sec. 5.2 of these *Provisions*, the response spectrum procedure in accordance with Sec. 5.3 of these *Provisions*, or the procedure prescribed in the specific adopted reference.

14.2.6 Seismic weight. The seismic weight, W , for nonbuilding structures shall include all dead loads as defined for structures in Sec. 5.2.1. For the purposes of calculating design seismic forces in nonbuilding structures, W also shall include all normal operating contents for items such as tanks, vessels, bins, hoppers, and piping. W shall include snow and ice loads where these loads constitute 25 percent or more of W or where required by the authority having jurisdiction based on local environmental conditions.

14.2.7 Rigid nonbuilding structures. Nonbuilding structures that have a fundamental period, T , less than 0.06 sec, including their anchorages, shall be designed for the base shear, V , obtained using Eq. 14.2-1 as follows:

$$V = 0.3S_{DS}IW \quad (14.2-1)$$

where:

- S_{DS} = the short period spectral response acceleration parameter, as determined in Sec. 3.3.3,
- I = the importance factor, as determined from Table 14.2-1, and
- W = the seismic weight.

In this case, the force shall be distributed with height in accordance with Sec. 5.2.3.

14.2.8 Minimum base shear. For nonbuilding systems that have an R value provided in Table 14.2-2, the minimum value specified in Sec. 5.2.1.1 shall be replaced by:

$$C_s = 0.03 \quad (14.2-2)$$

and the minimum value specified in Eq. 5.2-5 shall be replaced by:

$$C_s = \frac{0.8S_1}{R/I} \quad (14.2-3)$$

Exceptions:

1. Nonbuilding systems that have an R value provided in Table 14.2-3 and are designed to an adopted reference as modified by these *Provisions* shall be subject to the minimum base shear values defined by Equations 5.2-4 and 5.2-5.
2. Minimum base shear requirements need not apply to the convective (sloshing) component of liquid in tanks.

14.2.9 Fundamental period. The fundamental period of the nonbuilding structure shall be determined using the structural properties and deformation characteristics of the resisting elements in a properly substantiated analysis, such as the method described in Sec. 5.3.2.

When adopted references or other approved standards are not available, the fundamental period T may be computed using the following formula:

$$T = 2\pi \sqrt{\frac{\sum_{i=1}^n w_i \delta_i^2}{g \sum_{i=1}^n f_i \delta_i}} \quad (14.2-4)$$

The values of f_i represent any lateral force distribution in accordance with the principles of structural mechanics. The elastic deflections, δ_i , shall be calculated using the applied lateral forces, f_i .

Equations 5.2-6, 5.2-7 and 5.2-8 shall not be used for determining the period of a nonbuilding structure.

14.2.10 Vertical distribution of seismic forces. In addition to the methods prescribed in Chapter 5 of these *Provisions*, it shall be permitted to determine the vertical distribution of lateral seismic forces in accordance with an adopted reference or other standard that is approved by the authority having jurisdiction and is applicable to the specific type of nonbuilding structure.

14.2.11 Deformation requirements. The drift limits of Sec. 4.5.1 need not apply to nonbuilding structures if a rational analysis indicates they can be exceeded without adversely affecting structural stability or attached or interconnected components and elements (such as walkways and piping). P-delta effects shall be considered where critical to the function or stability of the structure.

Structures shall satisfy the separation requirements as determined in accordance with Sec. 4.5.1 unless specifically amended in this chapter.

14.2.12 Nonbuilding structure classification. Nonbuilding structures with structural systems that are designed and constructed in a manner similar to buildings and that have dynamic response similar to building structures shall be classified as “similar to buildings” and shall be designed in accordance with Sec. 14.3. All other nonbuilding structures shall be classified as “not similar to buildings” and shall be designed in accordance with Sec. 14.4.

14.3 NONBUILDING STRUCTURES SIMILAR TO BUILDINGS

Nonbuilding structures similar to buildings, as defined in Sec. 14.1.3, shall be designed in accordance with these *Provisions* as modified by this section and the specific adopted references.

14.3.1 Electrical power generating facilities. Electrical power generating facilities are power plants that generate electricity by steam turbines, combustion turbines, diesel generators, or similar turbo machinery. Such structures shall be designed in accordance with Sec. 14.2 of these *Provisions*.

14.3.2 Structural towers for tanks and vessels. Structural towers that support tanks and vessels shall be designed in accordance with Sec. 14.1.5. In addition, the following special considerations shall be included:

1. The distribution of the lateral base shear from the tank or vessel onto the supporting structure shall consider the relative stiffness of the tank and resisting structural elements.
2. The distribution of the vertical reactions from the tank or vessel onto the supporting structure shall consider the relative stiffness of the tank and resisting structural elements. Where the tank or vessel is supported on grillage beams, the calculated vertical reaction due to weight and overturning shall be increased at least 20 percent to account for nonuniform support. The grillage beam and vessel attachment shall be designed for this increased design value.
3. Calculation of the seismic displacements of the tank or vessel shall consider the deformation of the support structure where determining P-delta effects or evaluating required clearances to prevent pounding of the tank on the structure.

14.3.3 Piers and wharves. Piers and wharves are structures located in waterfront areas that project into a body of water. Two categories of these structures are:

- a. Piers and wharves with general public occupancy, such as cruise ship terminals, retail or commercial offices, restaurants, fishing piers and other tourist attractions.
- b. Piers and wharves where occupancy by the general public is not a consideration and economic considerations (on a regional basis, or for the owner) are a major design consideration, such as container wharves, marine oil terminals, bulk terminals, etc., or other structures whose primary function is to moor vessels and barges.

These structures shall conform to the building or building-like structural requirements of the Provisions or other rational criteria and methods of design and analysis. Any methods used for design of these structures should recognize the unique importance of liquefaction and soil failure collapse mechanisms, as well as consider all applicable marine loading combinations, such as mooring, berthing, wave and current. Structural detailing shall be carefully considered for the marine environment.

14.3.3.1 Additional seismic mass. Seismic forces on elements below the water level shall include the inertial force of the mass of the displaced water. The additional seismic mass equal to the mass of the displaced water shall be included as a lumped mass on the submerged element, and shall be added to the calculated seismic forces of the pier or wharf structure.

14.3.3.2 Soil effects. Seismic dynamic forces from the soil shall be determined by the registered design professional. The design shall account for the effects of liquefaction on piers and wharves, as appropriate.

14.3.4 Pipe racks. Pipe racks supported at the base shall be designed for the forces defined in Chapter 5 of these *Provisions*.

Displacements of the pipe rack shall be calculated using Eq. 5.2-15. The potential for interaction effects (pounding of the piping system) shall be considered based on these amplified displacements.

Piping systems, and their supports and attachments, shall be designed in accordance with Sec. 6.4.7. Friction resulting from gravity loads shall not be considered to provide resistance to seismic forces.

14.3.5 Steel storage racks. Steel storage racks supported below, at, or above grade shall be designed in accordance with this section.

14.3.5.1 Testing. Unless higher values of R are justified by test data, the seismic-force-resisting system shall be subject to the requirements and limitations of Sec. 14.2.4.

14.3.5.2 Importance factor. For storage racks in occupancies open to the general public, the importance factor, I , shall be taken as 1.5.

14.3.5.3 Operating weight. Steel storage racks shall be designed for each of the following conditions of operating weight, W .

1. Weight of the rack plus every storage level loaded to 67 percent of its rated load capacity.
2. Weight of the rack plus the highest storage level only loaded to 100 percent of its rated load capacity.

The design shall consider the actual height of the center of mass of each storage load component.

14.3.5.4 Vertical distribution of seismic forces. For all steel storage racks, the vertical distribution of seismic forces shall be as specified in Sec. 5.2.3 and in accordance with the following:

1. The base shear, V , of the steel storage rack shall be determined considering the loading conditions defined in Sec. 14.3.5.3.
2. The base of the structure shall be the floor supporting the steel storage rack. Each storage level of the rack shall be treated as a level of the structure, with heights h_i and h_x measured from the base of the structure.

3. The factor k may be taken as 1.0.

14.3.5.5 Seismic displacements. Steel storage rack installations shall accommodate the seismic displacement of the storage racks and their contents relative to all adjacent or attached components and elements. The assumed total relative displacement for storage racks shall not be less than 5 percent of the height above the base unless a smaller value is justified by test data or a properly substantiated analysis.

14.3.5.6 RMI storage racks. Steel storage racks designed in accordance with Sec. 2.7 of RMI shall be deemed to satisfy the seismic force and displacement requirements of these *Provisions* if all of the following conditions are met:

1. Where determining the value of C_a in Sec. 2.7.3 of RMI, the value of C_s is taken as equal to $S_{DS}/2.5$, the value of C_v is taken as equal to S_{DI} , and the value of I_p is taken equal to the importance factor, I , determined in accordance with Sec. 14.3.5.2;
2. The value of C_s in RMI is not taken less than $0.14S_{DS}$; and
3. For storage racks supported above grade, the value of C_s in RMI is not taken less than the value determined for F_p in accordance with Sec. 6.2.6 of these *Provisions* where R_p taken equal to R , a_p taken equal to 2.5, and I_p is taken equal to the importance factor, I , determined in accordance with Sec. 14.3.5.2.

14.4 NONBUILDING STRUCTURES NOT SIMILAR TO BUILDINGS

The following nonbuilding structures usually do not have lateral and vertical seismic-force-resisting-systems that are similar to buildings and shall be designed in accordance with these *Provisions* as modified by this section and the specific references.

14.4.1 General

14.4.1.1 Loads. Loads and load distributions that are less severe than those determined in accordance with these *Provisions* shall not be used.

14.4.1.2 Redundancy. The redundancy factor, ρ , shall be permitted to be taken as 1.

14.4.2 Earth retaining structures. This section applies to all earth retaining walls. The applied seismic forces shall be based on the recommendations in a geotechnical report prepared by a registered design professional in accordance with Sec. 7.5.1.

14.4.3 Stacks and chimneys. Stacks and chimneys are permitted to be either lined or unlined, and shall be constructed of concrete, steel, or masonry.

Steel stacks, concrete stacks, steel chimneys, concrete chimneys, and liners shall be designed to resist seismic lateral forces determined from a substantiated analysis using approved standards. Interaction of the stack or chimney with the liners shall be considered. A minimum separation shall be provided between the liner and chimney equal to C_d times the calculated differential lateral drift.

14.4.4 Amusement structures. Amusement structures are permanently fixed structures constructed primarily for the conveyance and entertainment of people. Such structures shall be designed to resist seismic lateral forces determined from a substantiated analysis using approved standards.

14.4.5 Special hydraulic structures. Special hydraulic structures are structures that are within liquid-containing structures and are exposed to liquids on both wall surfaces at the same head elevation under normal operating conditions. Under earthquake excitation, such structures are subjected to out-of-plane forces which arise due to differential hydrodynamic pressures. Special hydraulic structures include separation walls, baffle walls, weirs, and other similar structures.

Special hydraulic structures shall be designed for out-of-phase movement of the fluid. Unbalanced forces from the motion of the liquid must be applied simultaneously “in front of” and “behind” these elements.

Structures subject to hydrodynamic pressures induced by earthquakes shall be designed for rigid body and sloshing liquid forces and their own inertia force. The height of sloshing shall be determined and compared to the freeboard height of the structure.

Interior elements, such as baffles or roof supports, also shall be designed for the effects of unbalanced forces and sloshing.

14.4.6 Secondary containment systems. Secondary containment systems, such as impoundment dikes and walls, shall meet the requirements of the applicable standards for tanks and vessels and any additional requirements imposed by the authority having jurisdiction.

Secondary containment systems shall be designed to withstand the effects of a maximum considered earthquake when empty and a maximum considered earthquake when full, including all hydrodynamic forces.

Sloshing of the liquid within the secondary containment area shall be considered in determining the height of the impound. The freeboard provided shall not be less than the sloshing height, δ_s , determined using Eq. 14.4-9. For circular impoundment dikes, D shall be the diameter of the impoundment. For rectangular impoundment dikes, D shall be the longer horizontal plan dimension.

14.4.7 Tanks and vessels. This section applies to all tanks, vessels, bins, silos, and similar containers storing liquids, gases, or granular solids supported at the base (hereinafter referred to as “tanks and vessels”). Tanks and vessels covered herein include those constructed of reinforced concrete, prestressed concrete, steel, and fiber-reinforced plastic materials. The supports and attachments for tanks supported on elevated levels in buildings shall be designed in accordance with Chapter 6.

14.4.7.1 Design basis. Tanks and vessels storing liquids, gases, or granular solids shall satisfy the analysis and design requirements set forth in the applicable references as indicated in Table 14.1-1 and the additional requirements of these *Provisions* including the following:

1. Damping for the convective (sloshing) force component shall be taken as 0.5 percent unless otherwise define in an adopted reference or other approved standard.
2. Impulsive and convective components may be combined by taking the square root of the sum of the squares of the components.
3. Vertical earthquake effects shall be considered in accordance with the applicable approved standard. If the approved standard permits the user the option of including or excluding the vertical earthquake effects, to comply with these *Provisions*, they shall be included. For tanks and vessels not covered by an approved standard, the forces due to the vertical acceleration shall be defined as follows:
 - a. Hydrodynamic *vertical and lateral* forces in tank walls: The increase in hydrostatic pressures due to the vertical excitation of the contained liquid shall correspond to an effective increase in density, γ_L , of the stored liquid equal to $0.2S_{DS} \gamma_L$.
 - b. Hydrodynamic *hoop* forces in cylindrical tank walls: In a cylindrical tank wall, the *hoop* force per unit height, N_h , at level y from the base, associated with the vertical excitation of the contained liquid, shall be computed in accordance with Eq. 14.4-1

$$N_h = 0.2S_{DS}\gamma_L(H_L - y)(D_i/2) \quad (14.4-1)$$

where:

D_i = inside tank diameter (ft)

H_L = liquid height inside the tank (ft).

y = distance from base of the tank to level being investigated (ft).

$$\gamma_L = \text{unit weight of stored liquid (lb/ft}^3\text{)}$$

- c. Vertical *inertia* forces in cylindrical and rectangular tank walls: Vertical *inertia* forces associated with the vertical acceleration of the structure itself shall be taken equal to $0.2S_{DS}W$.

14.4.7.2 Strength and ductility. Structural components and members that are part of the lateral support system shall be designed to provide the following:

1. Connections and attachments for anchorage and other seismic-force-resisting components shall be designed to develop the lesser of the yield strength of the anchor or Ω_0 times the calculated element design load.
2. Penetrations, manholes, and openings in shell components shall be designed to maintain the strength and stability of the shell to carry tensile and compressive membrane shell forces.
3. Support towers for tanks and vessels with irregular bracing, unbraced panels, asymmetric bracing, or concentrated masses shall be designed using the provisions of Sec. 4.3.2 for irregular structures. Support towers using chevron or eccentric braced framing shall satisfy the appropriate requirements of these *Provisions*. Support towers using tension only bracing shall be designed such that the full cross section of the tension element can yield during overload conditions.
4. Compression struts that resist the reaction forces from tension braces shall be designed to resist the lesser of the yield strength of the brace (A_gF_y), or Ω_0 times the calculated tension load in the brace.
5. The vessel stiffness relative to the support system (foundation, support tower, skirt, etc.) shall be considered in determining forces in the vessel, the resisting components, and the connections.
6. For concrete liquid-containing structures, system ductility and energy dissipation under unfactored loads shall not be allowed to be achieved by inelastic deformations to such a degree as to jeopardize the serviceability of the structure. Stiffness degradation and energy dissipation shall be allowed to be obtained either through limited microcracking, or by means of lateral-force resistance mechanisms that dissipate energy without damaging the structure.

14.4.7.3 Flexibility of piping attachments. Design of piping systems connected to tanks and vessels shall consider the potential movement of the connection points during earthquakes and provide sufficient flexibility to avoid release of the product by failure of the piping system. The piping system and supports shall be designed so as not to impart significant mechanical loading on the attachment to the tank or vessel shell. Local loads at piping connections shall be considered in the design of the tank or vessel shell. Mechanical devices which add flexibility, such as bellows, expansion joints, and other flexible apparatus, may be used where they are designed for seismic displacements and defined operating pressure.

Unless otherwise calculated, the minimum displacements in Table 14.4-1 shall be assumed. For attachment points located above the support or foundation elevation, the displacements in Table 14.4-1 shall be increased to account for drift of the tank or vessel.

Table 14.4-1 Minimum Design Displacements for Piping Attachments

Condition	Displacement (in.)
Mechanically-anchored tanks and vessels:	
Upward vertical displacement relative to support or foundation	1
Downward vertical displacement relative to support or foundation	0.5
Range of displacement (radial and tangential) relative to support or foundation:	0.5
Self-anchored tanks and vessels (at grade):	
Upward vertical displacement relative to support or foundation	

If designed in accordance with an adopted reference.	1
Anchorage ratio less than or equal to 0.785 (indicates no uplift):	4
Anchorage ratio greater than 0.785 (indicates uplift):	
If designed for seismic loads in accordance with these <i>Provisions</i> but not covered by an adopted reference:	8
For tanks and vessels with a diameter less than 40 ft:	12
For tanks and vessels with a diameter equal to or greater than 40 ft:	
Downward vertical displacement relative to support of foundation	0.5
For tanks with a ringwall/mat foundation:	1
For tanks with a berm foundation:	2
Range of horizontal displacement (radial and tangential) relative to support or foundation	

The anchorage ratio, J, for self-anchored tanks is defined as:

$$J = \frac{M_{rw}}{D^2(w_t + w_a)} \tag{14.4-2}$$

Where:

$$w_t = \frac{W_s}{\pi D} + w_{rs}$$

w_{rs} = roof load acting on the shell in pounds per foot. Only permanent roof loads shall be included. Roof live load shall not be included.

w_a = weight of annular plate participating

M_{rw} = the ringwall overturning moment due to the seismic design loads

D = tank diameter

Anchorage Ratio

J anchorage ratio	Criteria
J < 0.785	No uplift under the design seismic overturning moment. The tank is self anchored.
0.785 < J < 1.54	Tank is uplifting, but the tank is stable for the design load providing the shell compression requirements are satisfied. Tank is self-anchored.
J > 1.54	Tank is not stable and cannot be self-anchored for the design load. Modify annular plate if $L < 0.035D$ is not controlling or add mechanical anchors.

Where the elastic deformations are calculated, the minimum design displacements for piping attachments shall be the calculated displacements at the point of attachment increased by the amplification factor C_d .

The values given in Table 14.4-1 do not include the influence of relative movements of the foundation and piping anchorage points due to foundation movements (such as settlement or seismic displacements). The effects of foundation movements shall be included in the design of the piping

system design, including the determination of the mechanical loading on the tank or vessel consideration of the total displacement capacity of the mechanical devices intended to add flexibility.

14.4.7.4 Anchorage. Tanks and vessels at grade are permitted to be designed without anchorage where they meet the requirements for unanchored tanks in approved standards. Tanks and vessels supported above grade on structural towers or building structures shall be anchored to the supporting structure.

The following special detailing requirements shall apply to steel tank anchor bolts in seismic regions where S_{DS} is greater than 0.5, or where the structure is assigned to Seismic Use Group III.

1. Hooked anchor bolts (L- or J-shaped embedded bolts) or other anchorage systems based solely on bond or mechanical friction shall not be used where S_{DS} is greater than 0.33. Post-installed anchors may be used provided that testing validates their ability to develop the yield load in the anchor when subjected to cyclic loads in cracked concrete.
2. Where anchorage is required, the anchor embedment into the foundation shall be designed to develop the minimum specified yield strength of the anchor.

14.4.7.5 Ground-supported storage tanks for liquids

14.4.7.5.1 Seismic forces. Ground-supported, flat bottom tanks storing liquids shall be designed to resist the seismic forces calculated using one of the following procedures:

1. The base shear and overturning moment calculated in accordance with Sec. 14.2.7 of these *Provisions* assuming the tank and all its contents are a rigid mass system.
2. Tanks or vessels assigned to Seismic Use Group III or with a diameter greater than 20 ft shall be designed considering the hydrodynamic pressures of the liquid in determining the equivalent lateral forces and lateral force distribution in accordance with the appropriate references listed in Table 14.1-1 and Sec. 14.4.7 of these *Provisions*.
3. The force and displacement provisions of Sec 5.2 of these *Provisions*.

The design of tanks storing liquids shall consider the impulsive and convective (sloshing) effects and consequences on the tank, foundation, and attached elements. The impulsive component corresponds to the high frequency amplified response to the lateral ground motion of the tank roof, shell, and portion of the contents that moves in unison with the shell. The convective component corresponds to the low frequency amplified response of the contents in the fundamental sloshing mode. The following definitions shall apply:

T_c = natural period of the first (convective) mode of sloshing,

T_i = fundamental period of the tank structure and impulsive component of the contents,

T_v = natural period of vertical vibration of the liquid and tank structural system,

V_i = base shear due to impulsive component from the weight of tank and its contents,

V_c = base shear due to the convective component of the effective sloshing mass,

W_i = impulsive weight (impulsive component of liquid, roof and equipment, shell, bottom and internal components).

W_c = the portion of the liquid weight sloshing.

The seismic base shear is the combination of the impulsive and convective components:

$$V = \sqrt{V_i^2 + V_c^2} \quad (14.4-3)$$

where:

$$V_i = \frac{S_{ai}}{R} W_i \quad (14.4-4)$$

$$V_c = \frac{S_{ac}}{R_c} W_c \quad (14.4-5)$$

where

R_c = the force reduction factor for the convective force = 1.5

S_{ai} = the spectral acceleration, in terms of the acceleration due to gravity, including the site impulsive components at period T_i and assuming 5 percent damping.

$$\text{For } T_i \leq T_s, S_{ai} = S_{DS}. \quad (14.4-6)$$

$$\text{For } T_i > T_s, S_{ai} = \frac{S_{DI}}{T_i} \quad (14.4-7)$$

Note: Where an adopted reference or other approved standard is used in which the spectral acceleration for the tank shell and the impulsive component of the liquid is independent of T_i , S_{ai} shall be taken equal to S_{DS} , for all cases.

S_{ac} = the spectral acceleration of the sloshing liquid based on the sloshing period T_c and assuming 0.5 percent damping.

$$\text{For } T_c \leq 4.0 \text{ sec, } S_{ac} = \frac{1.5S_{DI}}{T_c} \leq S_{DS} \quad (14.4-8)$$

$$\text{For } T_c > 4.0 \text{ sec, } S_{ac} = \frac{6S_{DI}}{T_c^2} \quad (14.4-9)$$

The natural period of the first (convective) mode of sloshing shall be determined using Eq. 14.4-10 as follows:

$$T_c = 2\pi \sqrt{\frac{D}{3.68g \tanh\left(\frac{3.68H}{D}\right)}} \quad (14.4-10)$$

where D = the tank diameter, H = liquid height, and g = the acceleration due to gravity.

The general design response spectra for ground-supported liquid storage tanks is shown in Figure 14.4-1.

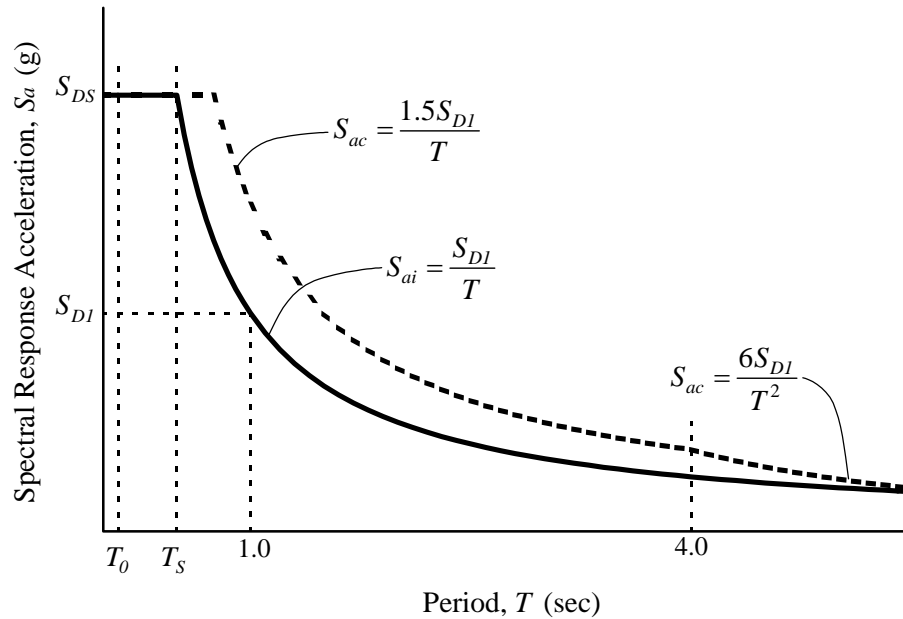

Figure 14.4-1 Design Response Spectra for Ground-supported Liquid Storage Tanks

14.4.7.5.2 Distribution of hydrodynamic and inertia forces. Unless otherwise required by the appropriate reference in Table 14.1-1, the method given ACI 350.3 may be used to determine the vertical and horizontal distribution of the hydrodynamic and inertia forces on the walls of circular and rectangular tanks.

14.4.7.5.3 Freeboard. Sloshing of the stored liquid shall be taken into account in the seismic design of tanks and vessels in accordance with the following provisions:

1. The *height of the sloshing wave*, δ_s , shall be computed using Eq. 14.4-11 as follows:

$$\delta_s = 0.5D_iIS_{ac} \quad (14.4-11)$$

For cylindrical tanks, D_i shall be the inside diameter of the tank; for rectangular tanks, the term D_i shall be replaced by the longer longitudinal plan dimension of the tank, L .

2. The *effects of sloshing* shall be accommodated by means of one of the following:
 - A minimum freeboard in accordance with Table 14.4-2.
 - A roof and supporting structure designed to contain the sloshing liquid in accordance with subsection 3 below.
 - For open-top tanks or vessels only, an overflow spillway around the tank or vessel perimeter.
3. If sloshing is restricted because the freeboard provided is less than the computed sloshing height, the roof in the vicinity of the roof-to-wall joint shall be permitted to be designed for an equivalent *hydrostatic* head equal to the computed sloshing height less the freeboard provided. In addition, the design of the tank shall take into account the fact that a portion of the confined convective (sloshing) mass becomes part of the impulsive mass in proportion to the degree of confinement.

Table 14.4-2 Minimum Required Freeboard^a

Value of S_{DS}	Seismic Use Group		
	I	II	III
$S_{DS} < 0.167$	— ^b	— ^b	δ_s
$0.167 \leq S_{DS} < 0.33$	— ^b	— ^b	δ_s
$0.33 \leq S_{DS} < 0.50$	— ^b	$0.7\delta_s$	δ_s
$0.50 \leq S_{DS}$	— ^b	$0.7\delta_s$	δ_s

^a The noted freeboard is required unless one of the following conditions is satisfied:
 1. Secondary containment in accordance with Sec. 14.4.6 is provided to control the product spill.
 2. The roof and supporting structure are designed to contain the sloshing liquid.
^b No minimum freeboard is required.

14.4.7.5.4 Equipment and attached piping. Equipment, piping, and walkways or other appurtenances attached to the structure shall be designed to accommodate the displacements imposed by seismic forces. For piping attachments, see Sec. 14.4.7.3.

14.4.7.5.5 Internal components. The attachments of internal equipment and accessories that are attached to the primary liquid or pressure retaining shell or bottom, or provide structural support for major components (such as a column supporting the roof rafters) shall be designed for the lateral loads due to the sloshing liquid in addition to the inertial forces.

14.4.7.5.6 Sliding resistance. The transfer of the total lateral shear force between the tank or vessel and the subgrade shall be considered as follows:

1. For unanchored, flat-bottom steel tanks, the overall horizontal seismic shear force shall be resisted by friction between the tank bottom and the foundation or subgrade. Unanchored storage tanks must be designed such that sliding will not occur when the tank is full of stored product. The maximum calculated seismic base shear, V , shall not exceed $N \tan(30^\circ)$.

N shall be determined using the effective weight of the tank, roof, and contents, after reduction for vertical earthquake effects. Values of the friction factor lower than $\tan(30^\circ)$ should be used if the condition at the bottom of the tank (such as a leak detection membrane beneath the bottom with a lower friction factor, smooth bottoms, etc.) is not consistent with such a friction value.

2. No additional lateral anchorage is required for anchored steel tanks designed in accordance with approved standards.
3. The lateral shear transfer behavior for special tank configurations (such as shovel bottoms, highly crowned tank bottoms, or tanks on grillage) can be unique and is beyond the scope of these Provisions.

14.4.7.5.7 Local shear transfer. Local transfer of the shear from the roof to the wall and for the wall of the tank into the base shall be considered. For cylindrical tanks and vessels, the peak local tangential shear per unit length shall be calculated using Eq. 14.4-12 as follows:

$$V_{max} = \frac{2V}{\pi D} \tag{14.4-12}$$

Shear transfer shall be accomplished as follows:

1. Tangential shear in flat-bottom steel tanks shall be transferred through the welded connection to the steel bottom. This transfer mechanism is deemed acceptable where S_{as} is less than 1.0 and the tank is designed in accordance with the approved standards.

2. For concrete tanks with a sliding base where the lateral shear is resisted by friction between the tank wall and the base, the friction coefficient shall not exceed $\tan(30 \text{ degrees})$.
3. In fixed-base or hinged-base concrete tanks, the total horizontal seismic base shear is transferred to the foundation by a combination of membrane (tangential) shear and radial shear. For anchored flexible-base concrete tanks, the majority of the base shear is resisted by membrane (tangential) shear through the anchoring system with only insignificant vertical bending in the wall. The connection between the wall and floor shall be designed to resist the maximum tangential shear.

14.4.7.5.8 Pressure stability. For steel tanks, the internal pressure from the stored product stiffens thin cylindrical shell structural elements subjected to membrane compression forces. This stiffening effect may be considered in resisting seismically induced compressive forces if permitted by the approved standard or the authority having jurisdiction.

14.4.7.5.9 Shell support. Steel tanks resting on concrete ring walls or slabs shall have a uniformly supported annulus under the shell. Uniform support shall be provided by one of the following methods:

1. Shimming and grouting the annulus,
2. Using fiberboard or other suitable padding,
3. Using butt-welded bottom or annular plates resting directly on the foundation, or
4. Using closely spaced shims (without structural grout) provided that the localized bearing loads are considered in the design of the tank wall and foundation so as to prevent local crippling and spalling.

Anchored tanks shall be shimmed and grouted. Local buckling of the steel shell for the peak compressive force due to operating loads and seismic overturning shall be considered.

14.4.7.5.10 Repair, alteration, or reconstruction. Repairs, modifications, or reconstruction (such as cut-down and re-erection) of a tank or vessel shall comply with industry standard practice and these *Provisions*. For welded steel tanks storing liquids, see API 653 and the adopted reference in Table 14.1-1. Tanks that are relocated shall be re-evaluated for the seismic loads for the new site and the requirements of new construction in accordance with the appropriate approved standard and these *Provisions*.

14.4.7.6 Water and water treatment tanks and vessels

14.4.7.6.1 Welded steel. Welded steel water storage tanks and vessels shall be designed in accordance with the seismic requirements of AWWA D100 except that the sloshing height shall be calculated in accordance with Sec 14.4.7.5.3 (rather than using Eq. 13-26 of AWWA D100) and design input forces shall be modified as follows:

1. The impulsive and convective components of the base shear for allowable stress design procedures shall be determined using the following equations, which shall be substituted into Eq. 13-4 and 13-8 of AWWA D100:

$$\text{For } T_s < T_c < 4.0 \text{ sec, } V_i = \frac{S_{DS}I}{1.4R} W_i \quad \text{and} \quad V_c = \frac{S_{DS}I}{1.4RT_c}$$

$$\text{For } T_c \geq 4.0 \text{ sec, } V_c = \frac{6S_{DS}I}{1.4R} \frac{T_s}{T_c^2} W_c$$

2. In Eq. 13-4, 13-8, and 13-20 through 13-25 of AWWA D100, the following changes shall be made:

$$\frac{ZI}{R_w} \text{ shall be replaced by } \frac{S_{DS}I}{2.5(1.4R)}, \text{ and}$$

the term S shall be replaced by the term B .

Where S_{DS} and T_s are determined in accordance with Chapter 3, R is determined in accordance with Sec. 14.2.4, and B is determined as follows:

$$\text{For } T_s < T_c < 4.0 \text{ sec, } B = 1.11T_s$$

$$\text{For } T_c \geq 4.0 \text{ sec, } B = 1.25T_s$$

Thus, Eq. 13-4 of AWWA D100, for base shear at the bottom of the tank shell, becomes

$$V_{ACT} = \frac{18S_{DS}I}{2.5(1.4R)} \left[0.14(W_s + W_r + W_f + W_l) + BC_l W_2 \right]$$

Alternatively,

$$\text{For } T_s < T_c < 4.0 \text{ sec, } V_{ACT} = \frac{S_{DS}I}{1.4R} \left[(W_s + W_r + W_f + W_l) + 1.5 \frac{T_s}{T_c} W_2 \right]$$

$$\text{For } T_s \geq 4.0 \text{ sec, } V_{ACT} = \frac{S_{DS}I}{1.4R} \left[(W_s + W_r + W_f + W_l) + 6 \frac{T_s}{T_c^2} W_2 \right]$$

Similarly, Eq. 13-8 of AWWA D100, for overturning moment applied to the bottom of the tank shell, becomes

$$M = \frac{18S_{DS}I}{2.5(1.4R)} \left[0.14(W_s X_s + W_r H_t + W_l X_l) + BC_l W_2 X_2 \right]$$

14.4.7.6.2 Bolted steel. Bolted steel water storage structures shall be designed in accordance with the seismic requirements of AWWA D103 except that the design input forces shall be modified in the same manner as shown in Sec 14.4.7.6.1 of these *Provisions*.

14.4.7.6.3 Reinforced and prestressed concrete. Reinforced and prestressed concrete tanks shall be designed in accordance with the seismic requirements of ACI 350.3 except that the design input forces shall be modified as follows:

1. For $T_i < T_0$ or $T_i > T_s$, the following terms shall be replaced by $\frac{S_a I}{1.4R}$:

For shear and overturning moment equations of AWWA D110 and AWWA D115, $\frac{ZIC_l}{R_l}$, and

For base shear and overturning moment equations of ACI 350.3, $\frac{ZISC_l}{R_i}$.

2. For $T_0 \leq T_i \leq T_s$, $\frac{ZIC_i}{R_l}$ and $\frac{ZISC_i}{R_i}$ shall be replaced by $\frac{S_{DS}I}{1.4R}$.

3. For all values of T_c (or T_w), $\frac{ZIC_c}{R_c}$ and $\frac{ZISC_c}{R_c}$ shall be replaced by $\frac{6S_{DI}I}{T_c^2}$ or $\frac{6S_{DS}I}{T_c^2} T_s$.

Thus, for $T_0 \leq T_i \leq T_s$,

$$\text{Eq. 4-1 of AWWA D110 becomes } V_l = \frac{S_{DS}I}{1.4R} (W_s + W_R + W_l), \text{ and}$$

$$\text{Eq. 4-2 of AWWA D110 becomes } V_c = \frac{6S_{DS}I}{1.4R} \left(\frac{T_s}{T_c^2} \right) W_c.$$

Where S_a , S_{DI} , S_{DS} , T_0 , and T_s are determined in accordance with Chapter 3 of these *Provisions*.

14.4.7.7 Petrochemical and industrial tanks and vessels storing liquids

14.4.7.7.1 Welded steel. Welded steel petrochemical and industrial tanks and vessels storing liquids shall be designed in accordance with the seismic requirements of API 650 and API 620 except that the design input forces shall be modified as indicated in this section.

Where using the equations in Sec. E.3 of API 650, the following substitutions shall be made in the equation for overturning moment M :

For $T_o < T_i \leq T_s$ 4.0 sec, $M = S_{DS}I \left[0.24(W_s X_s + W_t H_t + W_l X_l) + 0.80C_2 T_s W_2 X_2 \right]$, and

$$C_2 = \frac{0.75S}{T_c} \text{ and } S = 1.0$$

For $T_c > 4.0$ sec, $M = S_{DS}I \left[0.24(W_s X_s + W_t H_t + W_l X_l) + 0.71C_2 T_s W_2 X_2 \right]$, and

$$C_2 = \frac{3.375S}{T_c^2} \text{ and } S = 1.0.$$

Where S_{DS} and T_s are determined in accordance with Chapter 3 of these *Provisions*.

14.4.7.7.2 Bolted steel. Bolted steel tanks used for storage of production liquids are designed in accordance with API 12B, which covers the material, design, and erection requirements for vertical, cylindrical, above-ground, bolted tanks in nominal capacities of 100 to 10,000 barrels for production service. Unless required by the authority having jurisdiction, these temporary structures need not be designed for seismic loads. If design for seismic load is required, the loads may be adjusted for the temporary nature of the anticipated service life.

14.4.7.7.3 Reinforced and prestressed concrete. Reinforced concrete tanks for the storage of petrochemical and industrial liquids shall be designed in accordance with the force requirements of Sec. 14.4.7.6.3.

14.4.7.8 Ground-supported storage tanks for granular materials

14.4.7.8.1 Design considerations. In determining the effective mass and load paths, consideration shall be given to the intergranular behavior of the material as follows:

1. Increased lateral pressure (and the resulting hoop stress) due to loss of the intergranular friction of the material during the seismic shaking,
2. Increased hoop stresses resulting from temperature changes in the shell after the material has been compacted, and
3. Intergranular friction that can transfer seismic shear directly to the foundation.

14.4.7.8.2 Lateral force determination. The lateral forces for tanks and vessels storing granular materials at grade shall be determined using the requirements and accelerations for short period structures.

14.4.7.8.3 Force distribution to shell and foundation

14.4.7.8.3.1 Increased lateral pressure. The increase in lateral pressure on the tank wall shall be added to the static design lateral pressure but shall not be used in the determination of pressure stability effects on the axial buckling strength of the tank shell.

14.4.7.8.3.2 Effective mass. A portion of a stored granular mass will act with the shell (the effective mass). The effective mass is related to the physical characteristics of the product, the height-to-diameter (H/D) ratio of the tank and the intensity of the seismic event. The effective mass shall be used to determine the shear and overturning loads resisted by the tank.

14.4.7.8.3.3 Effective density. The effective density factor (that part of the total stored mass of product that is accelerated by the seismic event) shall be determined in accordance ACI 313.

14.4.7.8.3.4 Lateral sliding. For granular storage tanks that have a steel bottom and are supported such that friction at the bottom to foundation interface can resist lateral shear loads, no additional anchorage to prevent sliding is required. For tanks without steel bottoms (that is, where the material rests directly on the foundation), shear anchorage shall be provided to prevent sliding.

14.4.7.8.3.5 Combined anchorage systems. If separate anchorage systems are used to prevent overturning and sliding, the relative stiffness of the systems shall be considered in determining the load distribution.

14.4.7.8.4 Welded steel. Welded steel granular storage structures shall be designed for seismic forces determined in accordance with these *Provisions*. Component allowable stresses and materials shall be in accordance with AWWA D100, except that the allowable circumferential membrane stresses and material requirements in API 650 shall apply.

14.4.7.8.5 Bolted steel. Bolted steel granular storage structures shall be designed for seismic forces determined in accordance with these *Provisions*. Component allowable stresses and materials shall be in accordance with AWWA D103.

14.4.7.8.6 Reinforced and prestressed concrete. Reinforced and prestressed concrete structures for the storage of granular materials shall be designed for seismic forces determined in accordance with these *Provisions* and shall satisfy the requirements of ACI 313.

14.4.7.9 Elevated tanks and vessels for liquids and granular materials. This section applies to tanks, vessels, bins, and hoppers that are elevated above grade where the supporting tower is an integral part of the structure, or where the primary function of the tower is to support the tank or vessel. Tanks and vessels that are supported within buildings or are incidental to the primary function of the tower are considered mechanical equipment and shall be designed in accordance with Chapter 6 of these *Provisions*.

Elevated tanks shall be designed to satisfy the force and displacement requirements of the applicable approved standard, or these *Provisions*.

14.4.7.9.1 Effective mass. The design of the supporting tower or pedestal, anchorage, and foundation for seismic overturning shall assume the material stored is a rigid mass acting at the volumetric center of gravity. The effects of fluid-structure interaction may be considered in determining the forces, effective period, and mass centroids of the system if the following requirements are met:

1. The sloshing period, T_c is greater than $3T$ where T is the natural period of the tank (with the contents assumed to be rigid) and supporting structure.
2. The sloshing mechanism (percentage of convective mass and centroid) is determined for the specific configuration of the container by detailed fluid-structure interaction analysis or testing.
3. Soil-structure interaction in accordance with Sec. 5.6 may be included in determining T .

14.4.7.9.2 P-delta effects. The lateral drift of the elevated tank shall be considered as follows:

1. For evaluating the additional load in the support structure due to P-delta effects, the design drift shall be computed as the elastic lateral displacement at the center of gravity of the stored mass times the deflection amplification factor, C_d .
2. The base of the tank shall be assumed to be fixed rotationally and laterally.
3. Deflections due to bending, axial tension, or compression shall be considered. For pedestal tanks with a height-to-diameter ratio less than 5, shear deformations of the pedestal shall be considered.
4. The dead load effects of roof-mounted equipment or platforms shall be included in the analysis.

5. If constructed within the plumbness tolerances specified in the approved standard, initial tilt need not be considered in the P-delta analysis.

14.4.7.9.3 Transfer of lateral forces into support tower. For post-supported tanks and vessels that are cross-braced:

1. The bracing shall be installed in such a manner as to provide uniform resistance to the lateral load (such as pre-tensioning or tuning to attain equal sag).
2. The additional load in the brace due to the eccentricity between the post-to-tank attachment and the line of action of the bracing shall be included.
3. Eccentricity of compression strut lines of action with their attachment points shall be considered.
4. The connection of the post or leg with the foundation shall be designed to resist both the vertical and lateral resultant from the yield load in the bracing assuming the direction of the lateral load is oriented to produce the maximum lateral shear at the post-to-foundation interface. Where multiple rods are connected to the same location, the anchorage shall be designed to resist the concurrent tensile loads in the braces.

14.4.7.9.4 Evaluation of structures sensitive to buckling failure. Shell structures that support substantial loads may exhibit a primary mode of failure from localized or general buckling of the support pedestal or skirt during seismic loads. Such structures may include single pedestal water towers, skirt-supported process vessels, and similar single member towers. Where the structural assessment concludes that buckling of the support is the governing primary mode of failure, structures and components assigned to Seismic Use Group III shall be designed to resist the seismic forces as follows:

1. The seismic response coefficient for this evaluation shall be determined in accordance with Sec. 5.2.1.1 with R/I taken equal to 1.0. Soil-structure and fluid-structure interaction may be included when determining the structural response. Vertical or orthogonal combinations need not be considered.
2. The resistance of the structure or component shall be defined as the critical buckling resistance of the element with a factor of safety taken equal to 1.0.
3. The anchorage and foundation shall be designed to resist the load determined in item 1. The foundation shall be proportioned to provide a stability ratio of 1.2 for the overturning moment. The maximum toe pressure under the foundation shall not exceed the lesser of the ultimate bearing capacity or 3 times the allowable bearing capacity. All structural components and elements of the foundation shall be designed to resist the combined loads with a load factor of 1.0 on all loads, including dead load, live load, and earthquake load. Anchors shall be permitted to yield.

14.4.7.9.5 Welded steel. Welded steel elevated water storage structures shall be designed and detailed in accordance with the seismic requirements of AWWA D100 and these *Provisions* except that in using Eq. 13-1 and 13-3 of AWWA D100 S shall be taken equal to 1.0 and the term shall be replaced by the following:

$$\text{For } T < T_s, \frac{S_{DS}I}{1.4R},$$

$$\text{For } T_s \leq T \leq 4.0 \text{ sec, } \frac{S_{DI}I}{T(1.4R)}, \text{ and}$$

$$\text{For } T > 4.0 \text{ sec, } \frac{S_{DI}I}{T^2(1.4R)}.$$

14.4.7.9.5.1 Analysis procedures. The equivalent lateral force procedure may be used. A more rigorous analysis shall be permitted. Analysis of single pedestal structures shall be based on a fixed-

base, single degree-of-freedom model. All mass, including the contents, shall be considered rigid unless the sloshing mechanism (percentage of convective mass and centroid) is determined for the specific configuration of the container by detailed fluid-structure interaction analysis or testing. Soil-structure interaction may be included.

14.4.7.9.5.2 Structure period. The fundamental period of vibration of the structure shall be established using the structural properties and deformational characteristics of the resisting elements in a substantiated analysis. The period used to calculate the seismic response coefficient shall not exceed 4.0 seconds. See AWWA D100 for guidance on computing the fundamental period of cross-braced structures.

14.4.7.9.6 Concrete pedestal (composite) tanks. Concrete pedestal (composite) elevated water storage structures shall be designed in accordance with the requirements of ACI 371 except that the design input forces shall be modified as follows:

1. In Eq. 4-8a of ACI 371,

For $T_s \leq T \leq 4.0$ sec, $\frac{1.2C_v}{RT^{2/3}}$ shall be replaced by $\frac{S_{DI}I}{TR}$, and

For $T > 4.0$ sec, $\frac{1.2C_v}{RT^{2/3}}$ shall be replaced by $\frac{4S_{DI}I}{T^2R}$.

2. In Eq. 4-8b of ACI 371, $\frac{2.5C_a}{R}$ shall be replaced by $\frac{S_{DS}I}{R}$.

3. In Eq. 4-9 of ACI 371, $0.5C_a$ shall be replaced by $0.2S_{DS}$.

14.4.7.9.6.1 Analysis procedures. The equivalent lateral force procedure may be used for all structures and shall be based on a fixed-base, single-degree-of-freedom model. All mass, including that of the contents, shall be considered rigid unless the sloshing mechanism (percentage of convective mass and centroid) is determined for the specific configuration of the container by detailed fluid-structure interaction analysis or testing. Soil-structure interaction may be included. A more rigorous analysis is permitted.

14.4.7.9.6.2 Structure period. The fundamental period of vibration of the structure shall be established using the uncracked structural properties and deformational characteristics of the resisting elements in a properly substantiated analysis. The period used to calculate the seismic response coefficient shall not exceed 2.5 seconds.

14.4.7.10 Boilers and pressure vessels. Supports and attachments for boilers and pressure vessels shall be designed to satisfy the requirements of Chapter 6 and the additional requirements of this section. Boilers and pressure vessels assigned to Seismic Use Group II or III shall be designed to satisfy the force and displacement requirements of Chapter 6.

14.4.7.10.1 ASME boilers and pressure vessels. Boilers and pressure vessels designed and constructed in accordance with ASME BPV shall be deemed to satisfy the seismic force and relative displacement requirements of these *Provisions* provided that the forces and displacements defined in Chapter 6 are used in lieu of the seismic forces and displacements defined in ASME BPV.

14.4.7.10.2 Attachments of internal equipment and refractory. Attachments to the pressure boundary for internal and external ancillary components (refractory, cyclones, trays, etc.) shall be designed to resist the seismic forces in these *Provisions* to safeguard against rupture of the pressure boundary. Alternatively, the element attached to the boiler or pressure vessel may be designed to fail prior to damaging the pressure boundary provided that the pressure boundary is not jeopardized as a consequence of the failure. For boilers or vessels containing liquids, the effect of sloshing on the internal equipment shall be considered if the equipment can damage the pressure boundary.

14.4.7.10.3 Coupling of vessel and support structure. Where the mass of the operating vessel or vessels supported is greater than 25 percent of the total mass of the combined system, the coupling of the masses shall be considered. Coupling with adjacent, connected structures such as multiple towers shall be considered if the structures are interconnected with elements that will transfer loads from one structure to the other.

14.4.7.10.4 Effective mass. Fluid-structure interaction (sloshing) shall be considered in determining the effective mass of the stored material provided that sufficient liquid surface exists for sloshing to occur and the sloshing period, T_c , is greater than $3T$. Changes to or variations in material density with pressure and temperature shall be considered.

14.4.7.10.5 Other boilers and pressure vessels. Boilers and pressure vessels that are assigned to Seismic Use Group III but are not designed and constructed in accordance with the requirements of ASME BPV shall satisfy the following requirements:

1. Provision shall be made to eliminate seismic impact for components vulnerable to impact, for components constructed of nonductile materials, and in cases where material ductility will be reduced due to service conditions (such as low temperature applications).
2. The design strength for seismic loads in combination with other service loads and appropriate environmental effects (such as corrosion) shall be based on the material properties indicated in Table 14.4-3.

Table 14.4-3 Design Material Properties

Material type	Minimum ratio of F_u/F_y	Design material strength	
		Vessel	Threaded Connection ^a
Ductile (such as steel, aluminum, or copper)	1.33 ^b	$0.9F_y$	$0.7F_y$
Semi-ductile	1.2 ^c	$0.7F_y$	$0.5F_y$
Nonductile (such as cast iron, ceramics, or fiberglass)	NA	$0.25F_u$	$0.20F_u$

^a Threaded connection to vessel or support system.
^b Minimum 20 percent elongation per the appropriate ASTM material specification.
^c Minimum 15 percent elongation per the appropriate ASTM material specification.

14.4.7.10.6 Supports and attachments for boilers and pressure vessels. Supports for boilers and pressure vessels and attachments to the pressure boundary shall satisfy the following requirements:

1. Supports and attachments transferring seismic loads shall be constructed of ductile materials suitable for the intended application and environmental conditions.
2. Seismic anchorages embedded in concrete shall be ductile and detailed for cyclic loads.
3. Seismic supports and attachments to structures shall be designed and constructed so that the support or attachment remains ductile throughout the range of reversing seismic lateral loads and displacements.
4. In the design of vessel attachments, consideration shall be given to the potential effects on the vessel and the support due to uneven vertical reactions based on variations in relative stiffness of the support members, dissimilar details, non-uniform shimming, or irregular supports and uneven distribution of lateral forces based on the relative distribution of the resisting elements, the behavior of the connection details, and vessel shear distribution.

The requirements of Sec. 14.4.7.9.4 shall apply.

14.4.7.11 Liquid and gas spheres. Supports and attachments for liquid and gas spheres shall be designed to satisfy the requirements of Chapter 6 and the additional requirements of this section. Spheres assigned to Seismic Use Group II or III shall be designed to satisfy the force and displacement requirements of Chapter 6.

14.4.7.11.1 ASME spheres. Spheres designed and constructed in accordance with Division VIII of ASME BPV shall be deemed to satisfy the seismic force and relative displacement requirements of these *Provisions* provided that the forces and displacements defined in Chapter 6 are used in lieu of the seismic forces and displacements defined in ASME BPV.

14.4.7.11.2 Attachments of internal equipment and refractory. Attachments to the pressure or liquid boundary for internal and external ancillary components (refractory, cyclones, trays, etc.) shall be designed to resist the seismic forces in these *Provisions* to safeguard against rupture of the pressure boundary. Alternatively, the element attached to the sphere may be designed to fail prior to damaging the pressure or liquid boundary provided that the pressure boundary is not jeopardized as a consequence of the failure. For spheres containing liquids, the effect of sloshing on the internal equipment shall be considered if the equipment can damage the pressure boundary.

14.4.7.11.3 Effective mass. Fluid-structure interaction (sloshing) shall be considered in determining the effective mass of the stored material provided that sufficient liquid surface exists for sloshing to occur and the sloshing period, T_s , is greater than $3T$. Changes to or variations in fluid density shall be considered.

14.4.7.11.4 Post and rod supported. For post supported spheres that are cross-braced:

1. The requirements of Sec. 14.4.7.9.3 shall apply.
2. The stiffening effect (reduction in lateral drift) of pre-tensioning of the bracing shall be considered in determining the natural period.
3. The slenderness and local buckling of the posts shall be considered.
4. Local buckling of the sphere shell at the post attachment shall be considered.
5. For spheres storing liquids, bracing connections shall be designed and constructed to develop the minimum published yield strength of the brace. For spheres storing gas vapors only, bracing connections shall be designed for Ω_0 times the maximum design load in the brace. Lateral bracing connections directly attached to the pressure or liquid boundary are prohibited.

14.4.7.11.5 Skirt supported. For skirt supported spheres, the following requirements shall apply:

1. The requirements of Section 14.4.7.9.4 shall apply.
2. The local buckling of the skirt under compressive membrane forces due to axial load and bending moments shall be considered.
3. Penetrations of the skirt support (manholes, piping, etc.) shall be designed and constructed so as to maintain the strength of the skirt without penetrations.

14.4.7.12 Refrigerated gas liquid storage tanks and vessels. The seismic design of the tanks and facilities for the storage of liquefied hydrocarbons and refrigerated liquids is beyond the scope of this section. The design of such tanks is addressed in part by various product and industry standards. See Commentary Sec. 14.1.2.2.

Exception: Low-pressure, welded steel storage tanks for liquefied hydrocarbon gas (such as LPG or butane) and refrigerated liquids (such as ammonia) may be designed in accordance with the requirements of Sec. 14.4.7.7 and API 620.

14.4.7.13 Horizontal, saddle-supported vessels for liquid or vapor storage. Horizontal vessels supported on saddles shall be designed to satisfy the force and displacement requirements of Chapter 6.

14.4.7.13.1 Effective mass. Changes to or variations in material density shall be considered. The design of the supports, saddles, anchorage, and foundation for seismic overturning shall assume the material stored is a rigid mass acting at the volumetric center of gravity.

14.4.7.13.2 Vessel design. Unless a more rigorous analysis is performed:

1. A horizontal vessel with a length-to-diameter ratio of 6 or more may be assumed to be a simply supported beam spanning between the saddles for the purposes of determining the natural period of vibration and global bending moment.
2. For horizontal vessels with a length-to-diameter ratio of less than 6, the effects of “deep beam shear” shall be considered where determining the fundamental period and stress distribution.
3. Local bending and buckling of the vessel shell at the saddle supports due to seismic load shall be considered. The stabilizing effects of internal pressure shall not be considered to increase the buckling resistance of the vessel shell.
4. If the vessel is a combination of liquid and gas storage, the vessel and supports shall be designed both with and without gas pressure acting (assume piping has ruptured and pressure does not exist).

Appendix to Chapter 14

OTHER NONBUILDING STRUCTURES

PREFACE: This appendix is a resource document for future voluntary standards and model code development. The guidelines contained in this appendix represent the current industry design practice for these types of nonbuilding structures.

These sections are included here so that the design community can gain familiarity with the concepts and update their standards. It is hoped that the various consensus design standards will be updated to include the design and construction methodology presented in this appendix. Please direct all feedback on this appendix to the BSSC.

A14.1 GENERAL

A14.1.1 Scope. This appendix includes design requirements for electrical transmission, substation, and distribution structures, telecommunications towers, and buried structures and performance criteria for tanks and vessels.

A14.1.2 References

IEEE 693 Institute of Electrical and Electronics Engineers, *Recommended Practices for Seismic Design of Substations*, Power Engineering Society, Piscataway, New Jersey, 1997.

A14.1.3 Definitions

Base shear: See Sec. 4.1.3.

Buried structures: Subgrade structures such as tanks, tunnels, and pipes.

Dead load: See Sec. 4.1.3.

Registered design professional: See Sec. 2.1.3.

Seismic Use Group: See Sec. 1.1.4.

Structure: See Sec. 1.1.4.

A14.1.4 Notation

C_d See Sec. 4.1.4.

C_S See Sec. 5.1.3.

I See Sec. 1.1.5.

R See Sec. 4.1.4.

S_{DI} See Sec. 3.1.4.

S_{DS} See Sec. 3.1.4.

T See Sec. 4.1.4.

V See Sec. 5.1.3.

W See Sec. 1.1.5.

Ω_0 See Sec. 4.1.4.

A14.2 DESIGN REQUIREMENTS

A14.2.1 Buried structures. Buried structures that are assigned to Seismic Use Group II or III, or warrant special seismic design as determined by the registered design professional, shall be identified in the geotechnical report. Such buried structures shall be designed to resist minimum seismic lateral forces and expected differential displacements determined from a properly substantiated analysis using approved procedures.

A14.3 PERFORMANCE CRITERIA FOR TANKS AND VESSELS

Tanks and vessels shall be designed to meet the minimum post-earthquake performance criteria as specified in Table A14.3-1. These criteria depend on the Seismic Use Group and content-related hazards of the tanks and vessels being considered.

Table A14.3-1 Performance Criteria for Tanks and Vessels

Performance Category ^a	Minimum Post-earthquake Performance
I	The structure shall be permitted to fail if the resulting spill does not pose a threat to the public or to adjoining Category I, II or III structures.
II	The structure shall be permitted to sustain localized damage, including minor leaks, if (a) such damage remains localized and does not propagate; and (b) the resulting leakage does not pose a threat to the public or to adjoining Category I, II or III structures.
III	The structure shall be permitted to sustain minor damage, and its operational systems or components (valves and controls) shall be permitted to become inoperative, if (a) the structure retains its ability to contain 100% of its contents; and (b) the damage is not accompanied by and does not lead to leakage.
IV ^b	The structure shall be permitted to sustain minor damage provided that (a) it shall retain its ability to contain 100% of its contents without leakage; and (b) its operational systems or components shall remain fully operational.
^a Performance Categories I, II, and III correspond to the Seismic Use Groups defined in Sec. 1.2 and tabulated in Table 14.2-1.	
^b For tanks and vessels in Performance Category IV, an Importance Factor, $I = 1.0$ shall be used.	

Chapter 15

STRUCTURES WITH DAMPING SYSTEMS

15.1 GENERAL

15.1.1 Scope. Every structure with a damping system and every portion thereof shall be designed and constructed in accordance with the requirements of these *Provisions* as modified by this Chapter. Where damping devices are used across the isolation interface of a seismically isolated structure, displacements, velocities, and acceleration shall be determined in accordance with Chapter 13.

15.1.2 Definitions

Base: See Sec. 4.1.3.

Base shear: See Sec. 4.1.3.

Component: See Sec. 1.1.4.

Damping device: A flexible structural element of the damping system that dissipates energy due to relative motion of each end of the device. Damping devices include all pins, bolts, gusset plates, brace extensions, and other components required to connect damping devices to the other elements of the structure. Damping devices may be classified as either displacement-dependent or velocity-dependent, or a combination thereof, and may be configured to act in either a linear or nonlinear manner.

Damping system: The collection of structural elements that includes all the individual damping devices, all structural elements or bracing required to transfer forces from damping devices to the base of the structure, and the structural elements required to transfer forces from damping devices to the seismic-force-resisting system.

Design displacement: See Sec. 13.1.2.

Design earthquake ground motion: See Sec. 1.1.4.

Displacement-dependent damping device: The force response of a displacement-dependent damping device is primarily a function of the relative displacement, between each end of the device. The response is substantially independent of the relative velocity between each of the device, and/or the excitation frequency.

Maximum displacement: See Sec. 13.1.2.

Maximum considered earthquake ground motion: See Sec. 3.1.3.

Registered design professional: See Sec. 2.1.3.

Seismic Design Category: See Sec. 1.1.4.

Seismic-force-resisting system: See Sec. 1.1.4.

Seismic forces: See Sec. 1.1.4.

Seismic response coefficient: See Sec. 5.1.2.

Site Class: See Sec. 3.1.3.

Structure: See Sec. 1.1.4.

Total design displacement: See Sec. 13.1.2.

Total maximum displacement: See Sec. 13.1.2.

Velocity-dependent damping device: The force-displacement relation for a velocity-dependent damping device is primarily a function of the relative velocity between each end of the device, and may also be a function of the relative displacement between each end of the device.

15.1.3 Notation

B_{ID}	Numerical coefficient as set forth in Table 15.6-1 for effective damping equal to β_{mI} ($m=1$) and period of structure equal to T_{ID} .
B_{IE}	Numerical coefficient as set forth in Table 15.6-1 for the effective damping equal to $\beta_I + \beta_{VI}$ and period equal to T_I .
B_{IM}	Numerical coefficient as set forth in Table 15.6-1 for effective damping equal to β_{mM} ($m=1$) and period of structure equal to T_{IM} .
B_{mD}	Numerical coefficient as set forth in Table 15.6-1 for effective damping equal to β_{mI} and period of structure equal to T_m .
B_{mM}	Numerical coefficient as set forth in Table 15.6-1 for effective damping equal to β_{mM} and period of structure equal to T_m .
B_R	Numerical coefficient as set forth in Table 15.6-1 for effective damping equal to β_R and the period of structure equal to T_R .
B_{V+I}	Numerical coefficient as set forth in Table 15.6-1 for effective damping equal to the sum of viscous damping in the fundamental mode of vibration of the structure in the direction of interest, β_{Vm} ($m = 1$), plus inherent damping, β_I , and period of structure equal to T_I .
C_d	See Sec. 4.1.4.
C_{mFD}	Force coefficient as set forth in Table 15.7-1.
C_{mFV}	Force coefficient as set forth in Table 15.7-2.
C_{SI}	Seismic response coefficient of the fundamental mode of vibration of the structure in the direction of interest, Sec. 15.4.2.4 or Sec. 15.5.2.4 ($m = 1$).
C_{Sm}	Seismic response coefficient of the m^{th} mode of vibration of the structure in the direction of interest, Sec. 15.4.2.4 ($m = 1$) or Sec. 15.4.2.6 ($m > 1$).
C_{SR}	Seismic response coefficient of the residual mode of vibration of the structure in the direction of interest, Sec. 15.5.2.8.
D_{ID}	Fundamental mode design displacement at the center rigidity of the roof level of structure in the direction under consideration, Sec. 15.5.3.2.
D_{IM}	Fundamental mode maximum displacement at the center of rigidity of the roof level of the structure in the direction under consideration, Sec. 15.5.3.5.
D_{mD}	Design displacement at the center of rigidity of the roof level of the structure due to the m^{th} mode of vibration in the direction under consideration, Sec. 15.4.3.2.
D_{mM}	Maximum displacement at the center of rigidity of the roof level of the structure due to the m^{th} mode of vibration in the direction under consideration, Sec. 15.4.3.5.
D_{RD}	Residual mode design displacement at the center of rigidity of the roof level of the structure in the direction under consideration, Sec. 15.5.3.2.
D_{RM}	Residual mode maximum displacement at the center of rigidity of the roof level of the structure in the direction under consideration, Sec. 15.5.3.5.
D_Y	Displacement at the center of rigidity of the roof level of the structure at the effective yield point of the seismic-force-resisting system, Sec. 15.6.3.

E_{loop}	See Sec. 13.1.3.
f_i	Lateral force at Level i of the structure distributed approximately in accordance with Sec. 5.2.3, Sec. 15.5.2.3.
F_{iI}	Inertial force at Level i (or mass point i) in the fundamental mode of vibration of the structure in the direction of interest, Sec. 15.5.2.9.
F_{im}	Inertial force at Level i (or mass point i) in the m^{th} mode of vibration of the structure in the direction of interest, Sec. 15.4.2.7.
F_{iR}	Inertial force at Level i (or mass point i) in the residual mode of vibration of the structure in the direction of interest, Sec. 15.5.2.9.
h_i	See Sec. 5.1.3.
h_r	Height of the structure above the base to the roof level, Sec. 15.5.2.3.
I	See Sec. 1.1.5.
q_H	Hysteresis loop adjustment factor as determined in Sec. 15.6.2.2.1.
m	See Sec. 5.1.3.
Q_{DSD}	Force in an element of the damping system required to resist design seismic forces of displacement-dependent damping devices, Sec. 15.7.3.3.
Q_E	See Sec. 4.1.4.
Q_{mDSV}	Forces in an element of the damping system required to resist design seismic forces of velocity-dependent damping devices due to the m^{th} mode of vibration of structure in the direction of interest, Sec. 15.7.3.3.
Q_{mSFRS}	Force in a element of the damping system equal to the design seismic force of the m^{th} mode of vibration of the seismic force resisting system in the direction of interest, 15.7.3.3.
R	See Sec. 4.1.4.
S_I	See Sec. 3.1.4.
S_{DI}	See Sec. 3.1.4.
S_{DS}	See Sec. 3.1.4.
S_{MI}	See Sec. 3.1.4.
S_{MS}	See Sec. 3.1.4.
T_0	See Sec. 3.1.4.
T_I	See Sec. 15.5.2.3.
T_{ID}	Effective period, in seconds, of the fundamental mode of vibration of the structure at the design displacement in the direction under consideration, as prescribed by Sec. 15.4.2.5 or Sec. 15.5.2.5.
T_{IM}	Effective period, in seconds, of the fundamental mode of vibration of the structure at the maximum displacement in the direction under consideration, as prescribed by Sec. 15.4.2.5 or Sec. 15.5.2.5.
T_m	See Sec. 5.1.3.
T_R	Period, in seconds, of the residual mode of vibration of the structure in the direction under consideration, Sec. 15.5.2.7.
T_S	See Sec. 3.1.4.

V	See Sec. 5.1.3.
V_m	Design value of the seismic base shear of the m^{th} mode of vibration of the structure in the direction of interest, Sec. 5.3.4 or Sec. 15.4.2.2.
V_{min}	Minimum allowable value of base shear permitted for design of the seismic-force-resisting system of the structure in the direction of interest, Sec. 15.2.2.1.
V_R	Design value of the seismic base shear of the residual mode of vibration of the structure in a given direction, as determined in Sec. 15.5.2.6.
W	See Sec. 1.1.5.
\bar{W}_I	Effective fundamental mode seismic weight determined in accordance with Eq. 5.3-2 for $m = 1$.
\bar{W}_R	Effective residual mode seismic weight determined in accordance with Eq. 15.5-13.
w_i	See Sec. 4.1.4.
w_x	See Sec. 1.1.5.
α	Velocity exponent relating damping device force to damping device velocity.
β_{mD}	Total effective damping of the m^{th} mode of vibration of the structure in the direction of interest at the design displacement, Sec. 15.6.2.
β_{mM}	Total effective damping of the m^{th} mode of vibration of the structure in the direction of interest at the maximum displacement, Sec. 15.6.2.
β_{HD}	Component of effective damping of the structure in the direction of interest due to post-yield hysteric behavior of the seismic-force-resisting system and elements of the damping system at effective ductility demand μ_D , Sec. 15.6.2.2.
β_{HM}	Component of effective damping of the structure in the direction of interest due to post-yield hysteric behavior of the seismic-force-resisting system and elements of the damping system at effective ductility demand, μ_M , Sec. 15.6.2.2.
β_I	Component of effective damping of the structure due to the inherent dissipation of energy by elements of the structure, at or just below the effective yield displacement of the seismic-force-resisting system, Sec. 15.6.2.1.
β_R	Total effective damping in the residual mode of vibration of the structure in the direction of interest, calculated in accordance with Sec. 15.6.2 ($\mu_D = 1.0$ and $\mu_M = 1.0$).
β_{Vm}	Component of effective damping of the m^{th} mode of vibration of the structure in the direction of interest due to viscous dissipation of energy by the damping system, at or just below the effective yield displacement of the seismic-force-resisting system, Sec. 15.6.2.3.
δ_i	Elastic deflection of Level i of the structure due to applied lateral force, f_i , Sec. 15.5.2.3.
δ_{iD}	Fundamental mode design earthquake deflection of Level i at the center of rigidity of the structure in the direction under consideration, Sec. 15.5.3.1.
δ_D	Total design earthquake deflection of Level i at the center of rigidity of the structure in the direction under consideration, Sec. 15.5.3.
δ_M	Total maximum earthquake deflection of Level i at the center of rigidity of the structure in the direction under consideration, Sec. 15.5.3.
δ_{RD}	Residual mode design earthquake deflection of Level i at the center of rigidity of the structure in the direction under consideration, Sec. 15.5.3.

δ_{im}	Deflection of Level i in the m^{th} mode of vibration at the center of rigidity of the structure in the direction under consideration, Sec. 15.6.2.3.
Δ_{ID}	Design earthquake story drift due to the fundamental mode of vibration of the structure in the direction of interest, Sec. 15.5.3.3.
Δ_D	Total design earthquake story drift of the structure in the direction of interest, Sec. 15.5.3.3.
Δ_M	Total maximum earthquake story drift of the structure in the direction of interest, Sec. 15.5.3.
Δ_{mD}	Design earthquake story drift due to the m^{th} mode of vibration of the structure in the direction of interest, Sec. 15.4.3.3.
Δ_{RD}	Design earthquake story drift due to the residual mode of vibration of the structure in the direction of interest, Sec. 15.5.3.3.
μ	Effective ductility demand on the seismic-force-resisting system in the direction of interest.
μ_D	Effective ductility demand on the seismic-force-resisting system in the direction of interest due to the design earthquake, Sec. 15.6.3.
μ_M	Effective ductility demand on the seismic-force-resisting system in the direction of interest due to the maximum considered earthquake, Sec. 15.6.3.
μ_{max}	Maximum allowable effective ductility demand on the seismic-force-resisting system due to design earthquake, Sec. 15.6.4.
ρ	See Sec. 4.1.4.
ϕ_{iI}	Displacement amplitude at Level i of the fundamental mode of vibration of the structure in the direction of interest, normalized to unity at the roof level, Sec. 15.5.2.3.
ϕ_{iR}	Displacement amplitude at Level i of the residual mode of vibration of the structure in the direction of interest normalized to unity at the roof level, Sec. 15.5.2.7.
Γ_1	Participation factor of fundamental mode of vibration of the structure in the direction of interest, Sec. 15.4.2.3 or Sec. 15.5.2.3 ($m = 1$).
Γ_m	Participation factor on the m^{th} mode of vibration of the structure in the direction of interest, Sec. 15.4.2.3.
Γ_R	Participation factor of the residual mode of vibration of the structure in the direction of interest, Sec. 15.5.2.7.
Ω_0	See Sec. 4.1.4.
∇_{ID}	Design earthquake story velocity due to the fundamental mode of vibration of the structure in the direction of interest, Sec. 15.5.3.4.
∇_D	Total design earthquake story velocity of the structure in the direction of interest, Sec. 15.4.3.4.
∇_M	Total maximum earthquake story velocity of the structure in the direction of interest, Sec. 15.5.3.
∇_{mD}	Design earthquake story velocity due to the m^{th} mode of vibration of the structure in the direction of interest, Sec. 15.4.3.4.

15.2 GENERAL DESIGN REQUIREMENTS

15.2.1 Seismic Design Category A. Seismic Design Category A structures with a damping system shall be designed using the design spectral response acceleration determined in accordance with Sec. 3.3.3 and the analysis methods and design provisions required for Seismic Design Category B structures.

15.2.2 System requirements. Design of the structure shall consider the basic requirements for the seismic-force-resisting system and the damping system as defined in the following sections. The seismic-force-resisting system shall have the required strength to meet the forces defined in Section 15.2.2.1. The combination of the seismic-force-resisting system and the damping system may be used to meet the drift requirement.

15.2.2.1 Seismic-force-resisting system. Structures that contain a damping system are required to have a basic seismic-force-resisting system that, in each lateral direction, conforms to one of the types indicated in Table 4.3-1.

The design of the seismic-force-resisting system in each direction shall satisfy the requirements of Sec. 15.7 and the following:

1. The seismic base shear used for design of the seismic-force-resisting system shall not be less than V_{min} , where V_{min} is determined as the greater of the values computed using Eq. 15.2-1 and 15.2-2 as follows:

$$V_{min} = \frac{V}{B_{V+l}} \quad (15.2-1)$$

$$V_{min} = 0.75V \quad (15.2-2)$$

where:

V = seismic base shear in the direction of interest, determined in accordance with Sec. 5.2,

B_{V+l} = numerical coefficient as set forth in Table 15.6-1 for effective damping equal to the sum of viscous damping in the fundamental mode of vibration of the structure in the direction of interest, $\beta_{Vm}(m=1)$, plus inherent damping, β_l , and period of structure equal to T_l .

Exception: The seismic base shear used for design of the seismic-force-resisting system shall not be taken as less than $1.0V$, if either of the following conditions apply:

- a. In the direction of interest, the damping system has less than two damping devices on each floor level, configured to resist torsion.
 - b. The seismic-force-resisting system has plan irregularity Type 1b (Table 4.3-2) or vertical irregularity Type 1b (Table 4.3-3).
2. Minimum strength requirements for elements of the seismic-force-resisting system that are also elements of the damping system or are otherwise required to resist forces from damping devices shall meet the additional requirements of Sec. 15.7.2.

15.2.2.2 Damping system. Elements of the damping system shall be designed to remain elastic for design loads including unreduced seismic forces of damping devices as required in Sec. 15.7.2, unless it is shown by analysis or test that inelastic response of elements would not adversely affect damping system function and inelastic response is limited in accordance with the requirements of Sec. 15.7.2.4.

15.2.3 Ground motion

15.2.3.1 Design spectra. Spectra for the design earthquake and the maximum considered earthquake developed in accordance with Sec. 13.2.3.1 shall be used for the design and analysis of all structures with a damping system. Site-specific design spectra shall be developed and used for design of all structures with a damping system if either of the following conditions apply:

1. The structure is located on a Class F site or
2. The structure is located at a site with S_l greater than 0.6.

15.2.3.2 Time histories. Ground-motion time histories for the design earthquake and the maximum considered earthquake developed in accordance with Sec. 13.2.3.2 shall be used for design and analysis of all structures with a damping system if either of the following conditions apply:

1. The structure is located at a site with S_I greater than 0.6.
2. The damping system is explicitly modeled and analyzed using the time history analysis method.

15.2.4 Procedure selection

All structures with a damping system shall be designed using linear procedures, nonlinear procedures, or a combination of linear and nonlinear procedures, as permitted in this section.

Regardless of the analysis method used, the peak dynamic response of the structure and elements of the damping system shall be confirmed by using the nonlinear response history procedure if the structure is located at a site with S_I greater than 0.6.

15.2.4.1 Nonlinear procedures. The nonlinear procedures of Sec. 15.3 are permitted to be used for design of all structures with damping systems.

15.2.4.2 Response spectrum procedure. The response spectrum procedure of Sec. 15.4 is permitted to be used for design of structures with damping systems provided that:

1. In the direction of interest, the damping system has at least two damping devices in each story, configured to resist torsion; and
2. The total effective damping of the fundamental mode, $\beta_{mD}(m = 1)$, of the structure in the direction of interest is not greater than 35 percent of critical.

15.2.4.3 Equivalent lateral force procedure. The equivalent lateral force procedure of Sec. 15.5 is permitted to be used for design of structures with damping systems provided that:

1. In the direction of interest, the damping system has at least two damping devices in each story, configured to resist torsion;
2. The total effective damping of the fundamental mode, $\beta_{mD}(m = 1)$, of the structure in the direction of interest is not greater than 35 percent of critical;
3. The seismic-force-resisting system does not have plan irregularity Type 1a or 1b (Table 4.3-2) or vertical irregularity Type 1a, 1b, 2, or 3 (Table 4.3-3);
4. Floor diaphragms are rigid as defined in Sec. 4.3.2.1; and
5. The height of the structure above the base does not exceed 100 ft (30 m).

15.2.5 Damping system

15.2.5.1 Device design. The design, construction, and installation of damping devices shall be based on maximum earthquake response and the following conditions:

1. Low-cycle, large-displacement degradation due to seismic loads;
2. High-cycle, small-displacement degradation due to wind, thermal, or other cyclic loads;
3. Forces or displacements due to gravity loads;
4. Adhesion of device parts due to corrosion or abrasion, biodegradation, moisture, or chemical exposure; and
5. Exposure to environmental conditions, including but not limited to temperature, humidity, moisture, radiation (e.g., ultraviolet light), and reactive or corrosive substances (e.g., salt water).

Damping devices subject to failure by low-cycle fatigue shall resist wind forces without slip, movement, or inelastic cycling.

The design of damping devices shall incorporate the range of thermal conditions, device wear, manufacturing tolerances, and other effects that cause device properties to vary during the design life of the device.

15.2.5.2 Multi-axis movement. Connection points of damping devices shall provide sufficient articulation to accommodate simultaneous longitudinal, lateral, and vertical displacements of the damping system.

15.2.5.3 Inspection and periodic testing. Means of access for inspection and removal of all damping devices shall be provided.

The registered design professional responsible for design of the structure shall establish an appropriate inspection and testing schedule for each type of damping device to ensure that the devices respond in a dependable manner throughout the design life. The degree of inspection and testing shall reflect the established in-service history of the damping devices, and the likelihood of change in properties over the design life of devices.

15.2.5.4 Quality control. As part of the quality assurance plan developed in accordance with Sec. 2.2.1, the registered design professional responsible for the structural design shall establish a quality control plan for the manufacture of damping devices. As a minimum, this plan shall include the testing requirements of Sec. 15.9.2.

15.3 NONLINEAR PROCEDURES

The stiffness and damping properties of the damping devices used in the models shall be based on or verified by testing of the damping devices as specified in Sec. 15.9. The nonlinear force-deflection characteristics of damping devices shall be modeled, as required, to explicitly account for device dependence on frequency, amplitude, and duration of seismic loading.

15.3.1 Nonlinear response history procedure. A nonlinear response history (time history) analysis shall utilize a mathematical model of the structure and the damping system as provided in Sec. 5.5.1 and this section. The model shall directly account for the nonlinear hysteretic behavior of elements of the structure and the damping devices to determine its response, through methods of numerical integration, to suites of ground motions compatible with the design response spectrum for the site.

The analysis shall be performed in accordance with Sec. 5.5 together with the requirements of this section. Inherent damping of the structure shall not be taken greater than five percent of the critical unless test data consistent with the levels of deformation at or just below the effective yield displacement of the seismic-force-resisting system support higher values.

If the calculated force in the element of the seismic-force-resisting system does not exceed 1.5 times its nominal strength, that element may be modeled as linear.

15.3.1.1 Damping device modeling. Mathematical models of displacement-dependent damping devices shall include the hysteretic behavior of the devices consistent with test data and accounting for all significant changes in strength, stiffness, and hysteretic loop shape. Mathematical models of velocity-dependent damping devices shall include the velocity coefficient consistent with test data. If this coefficient changes with time and/or temperature, such behavior shall be modeled explicitly. The elements of damping devices connecting damper units to the structure shall be included in the model.

Exception: If the properties of the damping devices are expected to change during the duration of the time history analysis, the dynamic response may be enveloped by the upper and lower limits of device properties. All these limit cases for variable device properties must satisfy the same conditions as if the time dependent behavior of the devices were explicitly modeled.

15.3.1.2 Response parameters. In addition to the response parameters given in Sec. 5.5.3 for each ground motion analyzed, individual response parameters consisting of the maximum value of the discrete damping device forces, displacements, and velocities, in the case of velocity-dependent devices, shall be determined.

If at least seven ground motions are analyzed, the design values of the damping device forces, displacements, and velocities shall be permitted to be taken as the average of the values determined by the analyses. If fewer than seven ground motions are analyzed, the design damping device forces, displacements, and velocities shall be taken as the maximum value determined by the analysis. A minimum of three ground motions shall be used.

15.3.2 Nonlinear static procedure. The nonlinear modeling described in Sec. A5.2.1 and the lateral loads described in Sec. A5.2.2 shall be applied to the seismic-force-resisting system. The resulting force-displacement curve shall be used in lieu of the assumed effective yield displacement, D_y , of Eq. 15.6-10 to calculate the effective ductility demand due to the design earthquake, μ_D , and due to the maximum considered earthquake, μ_M , in Equations 15.6-8 and 15.6-9, respectively. The value of (R/C_d) shall be taken as 1.0 in Eq. 15.4-4, 15.4-5, 15.4-8, and 15.4-9 for the response spectrum procedure, and in Eq. 15.5-6, 15.5-7 and 15.5-15 for the equivalent lateral force procedure.

15.4 RESPONSE SPECTRUM PROCEDURE

Where the response spectrum procedure is used to design structures with a damping system, the requirements of this section shall apply.

15.4.1 Modeling. A mathematical model of the seismic-force-resisting system and damping system shall be constructed that represents the spatial distribution of mass, stiffness and damping throughout the structure. The model and analysis shall comply with the requirements of Sec. 5.3.1 through 5.3.3 for the seismic-force-resisting system and to the requirements of this section for the damping system. The stiffness and damping properties of the damping devices used in the models shall be based on or verified by testing of the damping devices as specified in Sec. 15.9.

The elastic stiffness of elements of the damping system other than damping devices shall be explicitly modeled. Stiffness of damping devices shall be modeled depending on damping device type as follows:

1. *Displacement-Dependent Damping Devices:* Displacement-dependent damping devices shall be modeled with an effective stiffness that represents damping device force at the response displacement of interest (e.g., design story drift). Alternatively, the stiffness of hysteretic and friction damping devices may be excluded from response spectrum analysis provided design forces in displacement-dependent damping devices, Q_{DSD} , are applied to the model as external loads (Sec. 15.7.2.3).
2. *Velocity-Dependent Damping Devices:* Velocity-dependent damping devices that have a stiffness component (e.g., visco-elastic damping devices) shall be modeled with an effective stiffness corresponding to the amplitude and frequency of interest.

15.4.2 Seismic-force-resisting system

15.4.2.1 Seismic base shear. The seismic base shear, V , of the structure in a given direction shall be determined as the combination of modal components, V_m , subject to the limits of Eq. 15.4-1 as follows:

$$V \geq V_{min} \quad (15.4-1)$$

The seismic base shear, V , of the structure shall be determined by the square root sum of the squares or complete quadratic combination of modal base shear components, V_m .

15.4.2.2 Modal base shear. Modal base shear of the m^{th} mode of vibration, V_m , of the structure in the direction of interest shall be determined in accordance with Eq. 15.4-2 as follows:

$$V_m = C_{sm} \bar{W}_m \quad (15.4-2)$$

where:

C_{sm} = seismic response coefficient of the m^{th} mode of vibration of the structure in the direction of interest as determined from Sec. 15.4.2.4 ($m = 1$) or Sec. 15.4.2.6 ($m > 1$), and

\bar{W}_m = the effective gravity load of the m^{th} mode of vibration of the structure determined in accordance with Eq. 5.3-2.

15.4.2.3 Modal participation factor. The modal participation factor of the m^{th} mode of vibration, Γ_m , of the structure in the direction of interest shall be determined in accordance with Eq. 15.4-3 as follows:

$$\Gamma_m = \frac{\bar{W}_m}{\sum_{i=1}^n w_i \phi_{im}} \quad (15.4-3)$$

where:

ϕ_{im} = displacement amplitude at the i^{th} level of the structure for the fixed base condition in the m^{th} mode of vibration in the direction of interest, normalized to unity at the roof level.

15.4.2.4 Fundamental mode seismic response coefficient. The fundamental mode ($m = 1$) seismic response coefficient, C_{s1} , in the direction of interest shall be determined in accordance with Eq. 15.4-4 and 15.4-5 as follows:

$$\text{For } T_{1D} < T_s, C_{s1} = \left(\frac{R}{C_d} \right) \frac{S_{DS}}{\Omega_0 B_{1D}} \quad (15.4-4)$$

$$\text{For } T_{1D} \geq T_s, C_{s1} = \left(\frac{R}{C_d} \right) \frac{S_{D1}}{T_{1D} (\Omega_0 B_{1D})} \quad (15.4-5)$$

15.4.2.5 Effective fundamental mode period determination. The effective fundamental mode ($m = 1$) period at the design earthquake, T_{1D} , and at the maximum considered earthquake, T_{1M} , shall be based either on explicit consideration of the post-yield nonlinear force deflection characteristics of the structure or determined in accordance with Eq. 15.4-6 and 15.4-7 as follows:

$$T_{1D} = T_1 \sqrt{\mu_D} \quad (15.4-6)$$

$$T_{1M} = T_1 \sqrt{\mu_M} \quad (15.4-7)$$

15.4.2.6 Higher mode seismic response coefficient. Higher mode ($m > 1$) seismic response coefficient, C_{sm} , of the m^{th} mode of vibration ($m > 1$) of the structure in the direction of interest shall be determined in accordance with Eq. 15.4-8 and 15.4-9 as follows:

$$\text{For } T_m < T_s, C_{sm} = \left(\frac{R}{C_d} \right) \frac{S_{DS}}{\Omega_0 B_{mD}} \quad (15.4-8)$$

$$\text{For } T_m \geq T_s, C_{sm} = \left(\frac{R}{C_d} \right) \frac{S_{D1}}{T_m (\Omega_0 B_{mD})} \quad (15.4-9)$$

where:

T_m = period, in seconds, of the m^{th} mode of vibration of the structure in the direction under consideration, and

B_{mD} = numerical coefficient as set forth in Table 15.6-1 for effective damping equal to β_{mD} and period of the structure equal to T_m .

15.4.2.7 Design lateral force. Design lateral force at Level i due to m^{th} mode of vibration, F_{im} , of the structure in the direction of interest shall be determined in accordance with Eq. 15.4-10 as follows:

$$F_{im} = w_i \phi_{im} \frac{\Gamma_m}{\bar{W}_m} V_m \quad (15.4-10)$$

Design forces in elements of the seismic-force-resisting system shall be determined by the square root of the sum of the squares or complete quadratic combination of modal design forces.

15.4.3 Damping system. Design forces in damping devices and other elements of the damping system shall be determined on the basis of the floor deflection, story drift and story velocity response parameters described in the following sections.

Displacements and velocities used to determine maximum forces in damping devices at each story shall account for the angle of orientation from horizontal and consider the effects of increased response due to torsion required for design of the seismic-force-resisting system.

Floor deflections at Level i , δ_{iD} and δ_{iM} , design story drifts, Δ_D and Δ_M , and design story velocities, ∇_D and ∇_M , shall be calculated for both the design earthquake and the maximum considered earthquake, respectively, in accordance with this section.

15.4.3.1 Design earthquake floor deflection. The deflection of structure due to the design earthquake at Level i in the m^{th} mode of vibration, δ_{imD} , of the structure in the direction of interest shall be determined in accordance with Eq. 15.4-11 as follows:

$$\delta_{imD} = D_{mD}\phi_{im} \quad (15.4-11)$$

The total design earthquake deflection at each floor of the structure shall be calculated by the square root of the sum of the squares or complete quadratic combination of modal design earthquake deflections.

15.4.3.2 Design earthquake roof displacement. Fundamental ($m = 1$) and higher mode ($m > 1$) roof displacements due to the design earthquake, D_{1D} and D_{mD} , of the structure in the direction of interest shall be determined in accordance with Eq. 15.4-12 and 15.4-13 as follows:

For $m=1$,

$$D_{1D} = \left(\frac{g}{4\pi^2} \right) \Gamma_1 \frac{S_{DS} T_{1D}^2}{B_{1D}} \geq \left(\frac{g}{4\pi^2} \right) \Gamma_1 \frac{S_{DS} T_1^2}{B_{1E}}, \quad T_{1D} < T_s \quad (15.4-12a)$$

$$D_{1D} = \left(\frac{g}{4\pi^2} \right) \Gamma_1 \frac{S_{D1} T_{1D}}{B_{1D}} \geq \left(\frac{g}{4\pi^2} \right) \Gamma_1 \frac{S_{D1} T_1}{B_{1E}}, \quad T_{1D} \geq T_s \quad (15.4-12b)$$

$$\text{For } m > 1, \quad D_{mD} = \left(\frac{g}{4\pi^2} \right) \Gamma_m \frac{S_{D1} T_m}{B_{mD}} \leq \left(\frac{g}{4\pi^2} \right) \Gamma_m \frac{S_{DS} T_m^2}{B_{mD}} \quad (15.4-13)$$

15.4.3.3 Design earthquake story drift. Design earthquake story drift of the fundamental mode, Δ_{1D} , and higher modes, Δ_{mD} ($m > 1$), of the structure in the direction of interest shall be calculated in accordance with Sec. 5.2.6.1 using modal roof displacements of Sec. 15.4.3.2.

Total design earthquake story drift, Δ_D , shall be determined by the square root of the sum of the squares or complete quadratic combination of modal design earthquake drifts.

15.4.3.4 Design earthquake story velocity. Design earthquake story velocity of the fundamental mode, ∇_{1D} , and higher modes, ∇_{mD} ($m > 1$), of the structure in the direction of interest shall be calculated in accordance with Eq. 15.4-14 and 15.4-15 as follows:

$$\text{For } m = 1, \quad \nabla_{1D} = 2\pi \frac{\Delta_{1D}}{T_{1D}} \quad (15.4-14)$$

$$\text{For } m > 1, \nabla_{mD} = 2\pi \frac{A_{mD}}{T_m} \quad (15.4-15)$$

Total design earthquake story velocity, ∇_D , shall be determined by the square root of the sum of the squares or complete quadratic combination of modal design earthquake velocities.

15.4.3.5 Maximum earthquake response. Total modal maximum earthquake floor deflection at Level i , design story drift values and design story velocity values shall be based on Sec. 15.4.3.1, 15.4.3.3 and 15.4.3.4, respectively, except design earthquake roof displacement shall be replaced by maximum earthquake roof displacement. Maximum earthquake roof displacement of the structure in the direction of interest shall be calculated in accordance with Eq. 15.4-16 and 15.4-17 as follows:

For $m=1$,

$$D_{1M} = \left(\frac{g}{4\pi^2} \right) \Gamma_1 \frac{S_{MS} T_{1M}^2}{B_{1M}} \geq \left(\frac{g}{4\pi^2} \right) \Gamma_1 \frac{S_{MS} T_1^2}{B_{1E}}, \quad T_{1M} < T_S \quad (15.4-16a)$$

$$D_{1M} = \left(\frac{g}{4\pi^2} \right) \Gamma_1 \frac{S_{M1} T_{1M}}{B_{1M}} \geq \left(\frac{g}{4\pi^2} \right) \Gamma_1 \frac{S_{M1} T_1}{B_{1E}}, \quad T_{1M} \geq T_S \quad (15.4-16b)$$

$$\text{For } m > 1, D_{mM} = \left(\frac{g}{4\pi^2} \right) \Gamma_m \frac{S_{M1} T_m}{B_{mM}} \leq \left(\frac{g}{4\pi^2} \right) \Gamma_m \frac{S_{MS} T_m^2}{B_{mM}} \quad (15.4-17)$$

where:

B_{mM} = numerical coefficient as set forth in Table 15.6-1 for effective damping equal to β_{mM} and period of the structure equal to T_m .

15.5 EQUIVALENT LATERAL FORCE PROCEDURE

Where the equivalent lateral force procedure is used to design structures with a damping system, the requirements of this section shall apply.

15.5.1 Modeling. Elements of the seismic-force-resisting system shall be modeled in a manner consistent with the requirements of Sec. 5.2. For purposes of analysis, the structure shall be considered to be fixed at the base.

Elements of the damping system shall be modeled as required to determine design forces transferred from damping devices to both the ground and the seismic-force-resisting system. The effective stiffness of velocity-dependent damping devices shall be modeled.

Damping devices need not be explicitly modeled provided effective damping is calculated in accordance with the procedures of Sec. 15.6 and used to modify response as required in Sec. 15.5.2 and 15.5.3.

The stiffness and damping properties of the damping devices used in the models shall be based on or verified by testing of the damping devices as specified in Sec. 15.9.

15.5.2 Seismic-force-resisting system

15.5.2.1 Seismic base shear. The seismic base shear, V , of the seismic-force-resisting system in a given direction shall be determined as the combination of the two modal components, V_I and V_R , in accordance with the following equation:

$$V = \sqrt{V_I^2 + V_R^2} \geq V_{min} \quad (15.5-1)$$

where:

- V_I = design value of the seismic base shear of the fundamental mode in a given direction of response, as determined in Sec. 15.5.2.2,
- V_R = design value of the seismic base shear of the residual mode in a given direction, as determined in Sec. 15.5.2.6, and
- V_{min} = minimum allowable value of base shear permitted for design of the seismic-force-resisting system of the structure in direction of the interest, as determined in Sec. 15.2.2.1.

15.5.2.2 Fundamental mode base shear. The fundamental mode base shear, V_I , shall be determined in accordance with the following equation:

$$V_I = C_{SI} \bar{W}_I \quad (15.5-2)$$

where:

- C_{SI} = the fundamental mode seismic response coefficient, as determined in Sec. 15.5.2.4, and
- \bar{W}_I = the effective fundamental mode gravity load including portions of the live load as defined by Eq. 5.3-2 for $m = 1$.

15.5.2.3 Fundamental mode properties. The fundamental mode shape, ϕ_{i1} , and participation factor, Γ_I , shall be determined by either dynamic analysis using the elastic structural properties and deformational characteristics of the resisting elements or using Eq. 15.5-3 and 15.5-4 as follows:

$$\phi_{i1} = \frac{h_i}{h_r} \quad (15.5-3)$$

$$\Gamma_I = \frac{\bar{W}_I}{\sum_{i=1}^n w_i \phi_{i1}} \quad (15.5-4)$$

where:

- h_i = the height of the structure above the base to Level i ,
- h_r = the height of the structure above the base to the roof level,
- w_i = the portion of the total gravity load, W , located at or assigned to Level i .

The fundamental period, T_I , shall be determined either by dynamic analysis using the elastic structural properties and deformational characteristics of the resisting elements, or using Eq. 15.5-5 as follows:

$$T_I = 2\pi \sqrt{\frac{\sum_{i=1}^n w_i \delta_i^2}{g \sum_{i=1}^n f_i \delta_i}} \quad (15.5-5)$$

where:

- f_i = lateral force at Level i of the structure distributed in accordance with Sec. 5.2.3, and
- δ_i = elastic deflection at Level i of the structure due to applied lateral forces f_i .

15.5.2.4 Fundamental mode seismic response coefficient. The fundamental mode seismic response coefficient, C_{SI} , shall be determined using Eq. 15.5-6 or 15.5-7 as follows:

$$\text{For } T_{ID} < T_S, C_{SI} = \left(\frac{R}{C_d} \right) \frac{S_{DI}}{\Omega_0 B_{1D}} \quad (15.5-6)$$

$$\text{For } T_{ID} \geq T_S, C_{SI} = \left(\frac{R}{C_d} \right) \frac{S_{DI}}{T_{ID} (\Omega_0 B_{ID})} \quad (15.5-7)$$

where:

- S_{DS} = the design spectral response acceleration parameter in the short period range,
 S_{DI} = the design spectral response acceleration parameter at a period of 1 second, and
 B_{ID} = numerical coefficient as set forth in Table 15.6-1 for effective damping equal to β_{mD} ($m = 1$) and period of the structure equal to T_{ID} .

15.5.2.5 Effective fundamental mode period determination. The effective fundamental mode period at the design earthquake, T_{ID} , and at the maximum considered earthquake, T_{IM} , shall be based on explicit consideration of the post-yield force deflection characteristics of the structure or shall be calculated using Eq. 15.5-8 and 15.5-9 as follows:

$$T_{ID} = T_I \sqrt{\mu_D} \quad (15.5-8)$$

$$T_{IM} = T_I \sqrt{\mu_M} \quad (15.5-9)$$

15.5.2.6 Residual mode base shear. Residual mode base shear, V_R , shall be determined in accordance with Eq. 15.5-10 as follows:

$$V_R = C_{SR} \bar{W}_R \quad (15.5-10)$$

where:

- C_{SR} = the residual mode seismic response coefficient as determined in Sec. 15.5.2.8, and
 \bar{W}_R = the effective residual mode gravity load of the structure determined using Eq. 15.5-13.

15.5.2.7 Residual mode properties. Residual mode shape, ϕ_{iR} , participation factor, Γ_R , effective gravity load of the structure, \bar{W}_R , and effective period, T_R , shall be determined using Eq. 15.5-11 through 15.5-14 as follows:

$$\phi_{iR} = \frac{1 - \Gamma_I \phi_{iI}}{1 - \Gamma_I} \quad (15.5-11)$$

$$\Gamma_R = 1 - \Gamma_I \quad (15.5-12)$$

$$\bar{W}_R = W - \bar{W}_I \quad (15.5-13)$$

$$T_R = 0.4T_I \quad (15.5-14)$$

15.5.2.8 Residual mode seismic response coefficient. The residual mode seismic response coefficient, C_{SR} , shall be determined in accordance with the following equation:

$$C_{SR} = \left(\frac{R}{C_d} \right) \frac{S_{DS}}{\Omega_0 B_R} \quad (15.5-15)$$

where:

- B_R = Numerical coefficient as set forth in Table 15.6-1 for effective damping equal to β_R , and period of the structure equal to T_R .

15.5.2.9 Design lateral force. The design lateral force in elements of the seismic-force-resisting system at Level i due to fundamental mode response, F_{iI} , and residual mode response, F_{iR} , of the structure in the direction of interest shall be determined in accordance with Eq. 15.5-16 and 15.5-17 as follows:

$$F_{iI} = w_i \phi_{iI} \frac{\Gamma_I}{\bar{W}_I} V_I \quad (15.5-16)$$

$$F_{iR} = w_i \phi_{iR} \frac{\Gamma_R}{\bar{W}_R} V_R \quad (15.5-17)$$

Design forces in elements of the seismic-force-resisting system shall be determined by taking the square root of the sum of the squares of the forces due to fundamental and residual modes.

15.5.3 Damping system. Design forces in damping devices and other elements of the damping system shall be determined on the basis of the floor deflection, story drift, and story velocity response parameters described in the following sections.

Displacements and velocities used to determine maximum forces in damping devices at each story shall account for the angle of orientation from horizontal and consider the effects of increased response due to torsion required for design of the seismic-force-resisting system.

Floor deflections at Level i , δ_{iD} and δ_{iM} , design story drifts, Δ_D and Δ_M , and design story velocities, ∇_D and ∇_M , shall be calculated for both the design earthquake and the maximum considered earthquake, respectively, in accordance with the following sections.

15.5.3.1 Design earthquake floor deflection. The total design earthquake deflection at each floor of the structure in the direction of interest shall be calculated as the square root of the sum of the squares of the fundamental and residual mode floor deflections. The fundamental and residual mode deflections due to the design earthquake, δ_{iID} and δ_{iRD} , at the center of rigidity of Level i of the structure in the direction of interest shall be determined using Eq. 15.5-18 and 15.5-19 as follows:

$$\delta_{iID} = D_{iD} \phi_{iI} \quad (15.5-18)$$

$$\delta_{iRD} = D_{iRD} \phi_{iR} \quad (15.5-19)$$

where:

D_{iD} = Fundamental mode design displacement at the center of rigidity of the roof level of the structure in the direction under consideration, Sec. 15.5.3.2.

D_{iRD} = Residual mode design displacement at the center of rigidity of the roof level of the structure in the direction under consideration, Sec. 15.5.3.2.

15.5.3.2 Design earthquake roof displacement. Fundamental and residual mode displacements due to the design earthquake, D_{iD} and D_{iR} , at the center of rigidity of the roof level of the structure in the direction of interest shall be determined using Eq. 15.5-20 and 15.5-21 as follows:

$$D_{iD} = \left(\frac{g}{4\pi^2} \right) \Gamma_1 \frac{S_{DS} T_{iD}^2}{B_{iD}} \geq \left(\frac{g}{4\pi^2} \right) \Gamma_1 \frac{S_{DS} T_1^2}{B_{1E}}, \quad T_{iD} < T_s \quad (15.5-20a)$$

$$D_{iD} = \left(\frac{g}{4\pi^2} \right) \Gamma_1 \frac{S_{D1} T_{iD}}{B_{iD}} \geq \left(\frac{g}{4\pi^2} \right) \Gamma_1 \frac{S_{D1} T_1}{B_{1E}}, \quad T_{iD} \geq T_s \quad (15.5-20b)$$

$$D_{iRD} = \left(\frac{g}{4\pi^2} \right) \Gamma_R \frac{S_{D1} T_{iR}}{B_R} \leq \left(\frac{g}{4\pi^2} \right) \Gamma_R \frac{S_{DS} T_R^2}{B_R}$$

15.5.3.3 Design earthquake story drift. Design earthquake story drifts, Δ_D , in the direction of interest shall be calculated using Eq. 15.5-22 as follows:

$$\Delta_D = \sqrt{\Delta_{ID}^2 + \Delta_{RD}^2} \quad (15.5-22)$$

where:

Δ_{ID} = design earthquake story drift due to the fundamental mode of vibration of the structure in the direction of interest, and

Δ_{RD} = design earthquake story drift due to the residual mode of vibration of the structure in the direction of interest.

Modal design earthquake story drifts, Δ_{ID} and Δ_{RD} , shall be determined in accordance with Eq. 5.3-8 using the floor deflections of Sec. 15.5.3.1

15.5.3.4 Design earthquake story velocity. Design earthquake story velocities, ∇_D , in the direction of interest shall be calculated in accordance with Eq. 15.5-23 through 15.5-25 as follows:

$$\nabla_D = \sqrt{\nabla_{ID}^2 + \nabla_{RD}^2} \quad (15.5-23)$$

$$\nabla_{ID} = 2\pi \frac{\Delta_{ID}}{T_{ID}} \quad (15.5-24)$$

$$\nabla_{RD} = 2\pi \frac{\Delta_{RD}}{T_R} \quad (15.5-25)$$

where:

∇_{ID} = design earthquake story velocity due to the fundamental mode of vibration of the structure in the direction of interest, and

∇_{RD} = design earthquake story velocity due to the residual mode of vibration of the structure in the direction of interest.

15.5.3.5 Maximum earthquake response. Total and modal maximum earthquake floor deflections at Level i , design story drifts, and design story velocities shall be based on the equations in Sec. 15.5.3.1, 15.5.3.3 and 15.5.3.4, respectively, except that design earthquake roof displacements shall be replaced by maximum earthquake roof displacements. Maximum earthquake roof displacements shall be calculated in accordance with Eq. 15.5-26 and 15.5-27 as follows:

$$D_{1M} = \left(\frac{g}{4\pi^2} \right) \Gamma_1 \frac{S_{MS} T_{1M}^2}{B_{1M}} \geq \left(\frac{g}{4\pi^2} \right) \Gamma_1 \frac{S_{MS} T_1^2}{B_{1E}}, \quad T_{1M} < T_S \quad (15.5-26a)$$

$$D_{1M} = \left(\frac{g}{4\pi^2} \right) \Gamma_1 \frac{S_{M1} T_{1M}}{B_{1M}} \geq \left(\frac{g}{4\pi^2} \right) \Gamma_1 \frac{S_{M1} T_1}{B_{1E}}, \quad T_{1M} \geq T_S \quad (15.5-26b)$$

$$D_{RM} = \left(\frac{g}{4\pi^2} \right) \Gamma_R \frac{S_{M1} T_R}{B_R} \leq \left(\frac{g}{4\pi^2} \right) \Gamma_R \frac{S_{MS} T_R^2}{B_R} \quad (15.5-27)$$

where:

- S_{MI} = the maximum considered earthquake, 5-percent-damped, spectral response acceleration at a period of 1 second, determined in accordance with Chapter 3.
- S_{MS} = the maximum considered earthquake, 5-percent-damped, spectral response acceleration at short periods, determined in accordance with Chapter 3.
- B_{IM} = Numerical coefficient as set forth in Table 15.6-1 for effective damping equal to β_{mM} ($m = 1$) and period of structure equal to T_{IM} .

15.6 DAMPED RESPONSE MODIFICATION

As required in Sec. 15.4 and 15.5, response of the structure shall be modified for the effects of the damping system.

15.6.1 Damping coefficient. Where the period of the structure is greater than or equal to T_0 , the damping coefficient shall be as prescribed in Table 15.6-1. Where the period of the structure is less than T_0 , the damping coefficient shall be linearly interpolated between a value of 1.0 at a 0-second period for all values of effective damping and the value at period T_0 as indicated in Table 15.6-1.

Table 15.6-1
Damping Coefficient, B_{V+I} , B_{ID} , B_R , B_{IM} , B_{mD} , or B_{mM}

Effective Damping, β (percentage of critical)	B_{V+I} , B_{ID} , B_R , B_{IM} , B_{mD} or B_{mM} (where period of the structure $\leq T_0$)
≤ 2	0.8
5	1.0
10	1.2
20	1.5
30	1.8
40	2.1
50	2.4
60	2.7
70	3.0
80	3.3
90	3.6
≤ 100	4.0

15.6.2 Effective damping. The effective damping at the design displacement, β_{mD} , and at the maximum displacement, β_{mM} , of the m^{th} mode of vibration of the structure in the direction under consideration shall be calculated using Eq. 15.6-1 and 15.6-2 as follows:

$$\beta_{mD} = \beta_I + \beta_{Vm} \sqrt{\mu_D} + \beta_{HD} \quad (15.6-1)$$

$$\beta_{mM} = \beta_I + \beta_{Vm} \sqrt{\mu_M} + \beta_{HM} \quad (15.6-2)$$

where:

- β_{HD} = component of effective damping of the structure in the direction of interest due to post-yield hysteretic behavior of the seismic-force-resisting system and elements of the damping system at effective ductility demand, μ_D ;

- β_{HM} = component of effective damping of the structure in the direction of interest due to post-yield hysteretic behavior of the seismic-force-resisting system and elements of the damping system at effective ductility demand, μ_M ;
- β_I = component of effective damping of the structure due to the inherent dissipation of energy by elements of the structure, at or just below the effective yield displacement of the seismic-force-resisting system;
- β_{vm} = component of effective damping of the m^{th} mode of vibration of the structure in the direction of interest due to viscous dissipation of energy by the damping system, at or just below the effective yield displacement of the seismic-force-resisting system;
- μ_D = effective ductility demand on the seismic-force-resisting system in the direction of interest due to the design earthquake; and
- μ_M = effective ductility demand on the seismic-force-resisting system in the direction of interest due to the maximum considered earthquake.

Unless analysis or test data supports other values, the effective ductility demand of higher modes of vibration in the direction of interest shall be taken as 1.0.

15.6.2.1 Inherent damping. Inherent damping, β_I , shall be based on the material type, configuration, and behavior of the structure and nonstructural components responding dynamically at or just below yield of the seismic-force-resisting system. Unless analysis or test data supports other values, inherent damping shall be taken as not greater than five percent of critical for all modes of vibration.

15.6.2.2 Hysteretic damping. Hysteretic damping of the seismic-force-resisting system and elements of the damping system shall be based either on test or analysis, or shall be calculated using Eq. 15.6-3 and 15.6-4 as follows:

$$\beta_{HD} = q_H (0.64 - \beta_I) \left(1 - \frac{1}{\mu_D} \right) \quad (15.6-3)$$

$$\beta_{HM} = q_H (0.64 - \beta_I) \left(1 - \frac{1}{\mu_M} \right) \quad (15.6-4)$$

where:

- q_H = hysteresis loop adjustment factor, as defined in Sec. 15.6.2.2.1,
- μ_D = effective ductility demand on the seismic-force-resisting system in the direction of interest due to the design earthquake, as defined in Sec. 15.6.3, and
- μ_M = effective ductility demand on the seismic-force-resisting system in the direction of interest due to the maximum considered earthquake, as defined in Sec. 15.6.3.

Unless analysis or test data supports other values, the hysteretic damping of higher modes of vibration in the direction of interest shall be taken as zero.

15.6.2.2.1 Hysteresis loop adjustment factor. The calculation of hysteretic damping of the seismic-force-resisting system and elements of the damping system shall consider pinching and other effects that reduce the area of the hysteresis loop during repeated cycles of earthquake demand. Unless analysis or test data support other values, the fraction of full hysteretic loop area of the seismic-force-resisting system used for design shall be taken as equal to the factor, q_H , using Eq. 15.6-5 as follows:

$$q_H = 0.67 \frac{T_S}{T_I} \quad (15.6-5)$$

where:

- T_S = period defined by the ratio, S_{D1}/S_{D5}

T_1 = period of the fundamental mode of vibration of the structure in the direction of the interest

The value of q_H shall not be taken as greater than 1.0, and need not be taken as less than 0.5.

15.6.2.3 Viscous damping. Viscous damping of the m^{th} mode of vibration of the structure, β_{vm} , shall be calculated using Eq. 15.6-6 and 15.6-7 as follows:

$$\beta_{vm} = \frac{\sum_j W_{mj}}{4\pi W_m} \quad (15.6-6)$$

$$W_m = \frac{1}{2} \sum_i F_{im} \delta_{im} \quad (15.6-7)$$

where:

W_{mj} = work done by j^{th} damping device in one complete cycle of dynamic response corresponding to the m^{th} mode of vibration of the structure in the direction of interest at modal displacements, δ_{im} ,

W_m = maximum strain energy in the m^{th} mode of vibration of the structure in the direction of interest at modal displacements, δ_{im} ,

F_{im} = m^{th} mode inertial force at Level i ,

δ_{im} = deflection of Level i in the m^{th} mode of vibration at the center of rigidity of the structure in the direction under consideration.

Viscous modal damping of displacement-dependent damping devices shall be based on a response amplitude equal to the effective yield displacement of the structure.

The calculation of the work done by individual damping devices shall consider orientation and participation of each device with respect to the mode of vibration of interest. The work done by individual damping devices shall be reduced as required to account for the flexibility of elements, including pins, bolts, gusset plates, brace extensions, and other components that connect damping devices to other elements of the structure.

15.6.3 Effective ductility demand. The effective ductility demand on the seismic-force-resisting system due to the design earthquake, μ_D , and due to the maximum considered earthquake, μ_M , shall be calculated using Eq. 15.6-8, 15.6-9, and 15.6-10 as follows:

$$\mu_D = \frac{D_{1D}}{D_Y} \geq 1.0 \quad (15.6-8)$$

$$\mu_M = \frac{D_{1M}}{D_Y} \geq 1.0 \quad (15.6-9)$$

$$D_Y = \left(\frac{g}{4\pi^2} \right) \left(\frac{\Omega_0 C_d}{R} \right) \Gamma_1 C_{s1} T_1^2 \quad (15.6-10)$$

where:

D_{1D} = fundamental mode design displacement at the center of rigidity of the roof level of the structure in the direction under consideration, Sec. 15.5.3.2,

D_{1M} = fundamental mode maximum displacement at the center of rigidity of the roof level of structure in the direction under consideration, Sec. 15.5.3.5,

D_Y = displacement at the center of rigidity of the roof level of the structure at the effective yield point of the seismic-force-resisting system,

R = response modification factor from Table 4.3-1,

- C_d = deflection amplification factor from Table 4.3-1,
 Ω_0 = system overstrength factor from Table 4.3-1,
 Γ_1 = participation factor of the fundamental mode of vibration of the structure in the direction of interest, Sec. 15.4.2.3 or Sec. 15.5.2.3 ($m = 1$),
 C_{SI} = seismic response coefficient of the fundamental mode of vibration of the structure in the direction of interest, Sec. 15.4.2.4 or Sec. 15.5.2.4 ($m = 1$), and
 T_1 = period of the fundamental mode of vibration of the structure in the direction of interest.

The design earthquake ductility demand, μ_D , shall not exceed the maximum value of effective ductility demand, μ_{max} , given in Sec. 15.6.4.

15.6.4 Maximum effective ductility demand. For determination of the hysteresis loop adjustment factor, hysteretic damping, and other parameters, the maximum value of effective ductility demand, μ_{max} , shall be calculated using Eq. 15.6-11 and 15.6-12 as follows:

$$\text{For } T_{ID} \leq T_S, \mu_{max} = \frac{1}{2} \left(\left(\frac{R}{\Omega_0 I} \right)^2 + 1 \right) \quad (15.6-11)$$

$$\text{For } T_1 \geq T_S, \mu_{max} = \frac{R}{\Omega_0 I} \quad (15.6-12)$$

For $T_1 < T_S < T_{ID}$, μ_{max} shall be determined by linear interpolation between the values of Eq. 15.6-11 and 15.6-12

where:

- I = the occupancy importance factor determined in accordance with Sec. 1.3.
 T_{ID} = effective period of the fundamental mode of vibration of the structure at the design displacement in the direction under consideration.

15.7 SEISMIC LOAD CONDITIONS AND ACCEPTANCE CRITERIA

For the nonlinear procedures of Sec. 15.3, the seismic-force-resisting system, damping system, loading conditions and acceptance criteria for response parameters of interest shall conform with Sec. 15.7.1. Design forces and displacements determined in accordance with the response spectrum procedure of Sec. 15.4 or the equivalent lateral force procedure of Sec. 15.5 shall be checked using the strength design criteria of the *Provisions* and the seismic loading conditions of Sec. 15.7.2 and 15.7.3.

15.7.1 Nonlinear procedures. Where nonlinear procedures are used in analysis, the seismic force resisting system, damping system, seismic loading conditions and acceptance criteria shall conform to the following subsections.

15.7.1.1 Seismic force resisting system. The seismic-force-resisting system shall satisfy the strength requirements of Sec. 4.3 using the seismic base shear, V_{min} , as given by Sec. 15.2.2.1.

15.7.1.2 Seismic loads. Seismic forces shall be based upon the design earthquake for damping system strength. The damping devices and their connections shall be sized to resist the forces, displacements and velocities from the maximum considered earthquake. The story drift shall be determined using the design earthquake.

15.7.1.3 Combination of load effects. The effects on the damping system due to gravity loads and seismic forces shall be combined in accordance with Sec. 4.2.2 using the effect of horizontal seismic forces, Q_E , determined in accordance with the analysis. The redundancy factor, ρ , shall be taken equal to 1.0 in all cases and the seismic load effect with overstrength of Sec. 4.2.2.2 need not apply to the design of the damping system.

15.7.1.4 Acceptance criteria for the response parameters of interest. The damping system components shall be evaluated using the strength design criteria of the *Provisions* using the seismic forces and seismic loading conditions determined from the nonlinear procedures and $\phi = 1.0$. The members of the seismic-force-resisting system need not be evaluated when using the nonlinear procedure forces.

The story drift shall not exceed 125 percent of the allowable story drift, Δ_a , as obtained from Table 4.5-1. The maximum story drift shall include torsional effects.

15.7.2 Seismic-force-resisting system. The seismic-force-resisting system shall satisfy the requirements of Sec. 4.3 using seismic base shear and design forces determined in accordance with Sec. 15.4.2 or Sec. 15.5.2.

The design earthquake story drift, Δ_D , as determined in either Sec. 15.4.3.3 or Sec. 15.5.3.3 shall not exceed (R/C_d) times the allowable story drift, as obtained from Table 4.5-1, considering the effects of torsion as required in Sec. 4.5.1.

15.7.3 Damping system. The damping system shall satisfy the requirements of Sec. 4.3 for seismic design forces and seismic loading conditions determined in accordance with this section.

15.7.3.1 Combination of load effects. The effects on the damping system and its components due to gravity loads and seismic forces shall be combined in accordance with Sec. 4.2.2 using the effect of horizontal seismic forces, Q_E , determined in accordance with Sec. 15.7.3.3. The redundancy factor, ρ , shall be taken equal to 1.0 in all cases and the seismic load effect with overstrength of Sec. 4.2.2.2 need not apply to the design of the damping system.

15.7.3.2 Modal damping system design forces. Modal damping system design forces shall be calculated on the basis of the type of damping devices and the modal design story displacements and velocities determined in accordance with either Sec. 15.4.3 or Sec. 15.5.3.

Modal design story displacements and velocities shall be increased as required to envelop the total design story displacements and velocities determined in accordance with Sec. 15.3 where peak response is required to be confirmed by time history analysis.

1. Displacement-Dependent Damping Devices: Design seismic force in displacement-dependent damping devices shall be based on the maximum force in the device at displacements up to and including the design earthquake story drift, Δ_D .
2. Velocity-Dependent Damping Devices: Design seismic force in each mode of vibration of velocity-dependent damping devices shall be based on the maximum force in the device at velocities up to and including the design earthquake story velocity for the mode of interest.

Displacements and velocities used to determine design forces in damping devices at each story shall account for the angle of orientation from horizontal and consider the effects of increased floor response due to torsional motions.

15.7.3.3 Seismic load conditions and combination of modal responses. Seismic design force, Q_E , in each element of the damping system due to horizontal earthquake load shall be taken as the maximum force of the following three loading conditions:

1. Stage of Maximum Displacement: Seismic design force at the stage of maximum displacement shall be calculated in accordance with Eq. 15.7-1 as follows:

$$Q_E = \Omega_o \sqrt{\sum_m (Q_{mSFERS})^2} \pm Q_{DSD} \quad (15.7-1)$$

where:

Q_{mSFERS} = Force in an element of the damping system equal to the design seismic force of the m^{th} mode of vibration of the seismic-force-resisting system in the direction of interest.

Q_{DSD} = Force in an element of the damping system required to resist design seismic forces of displacement-dependent damping devices.

Seismic forces in elements of the damping system, Q_{DSD} , shall be calculated by imposing design forces of displacement-dependent damping devices on the damping system as pseudo-static forces. Design seismic forces of displacement-dependent damping devices shall be applied in both positive and negative directions at peak displacement of the structure.

2. Stage of Maximum Velocity: Seismic design force at the stage of maximum velocity shall be calculated in accordance with Eq. 15.7-2 as follows:

$$Q_E = \sqrt{\sum_m (Q_{mDSV})^2} \quad (15.7-2)$$

where:

Q_{mDSV} = Force in an element of the damping system required to resist design seismic forces of velocity-dependent damping devices due to the m^{th} mode of vibration of structure in the direction of interest.

Modal seismic design forces in elements of the damping system, Q_{mDSV} , shall be calculated by imposing modal design forces of velocity-dependent devices on the non-deformed damping system as pseudo-static forces. Modal seismic design forces shall be applied in directions consistent with the deformed shape of the mode of interest. Horizontal restraint forces shall be applied at each floor Level i of the non-deformed damping system concurrent with the design forces in velocity-dependent damping devices such that the horizontal displacement at each level of the structure is zero. At each floor Level i , restraint forces shall be proportional to and applied at the location of each mass point.

3. Stage of Maximum Acceleration: Seismic design force at the stage of maximum acceleration shall be calculated in accordance Eq. 15.7-3 as follows:

$$Q_E = \sqrt{\sum_m (C_{mFD} \Omega_o Q_{mSFRS} + C_{mFV} Q_{mDSV})^2} \pm Q_{DSD} \quad (15.7-3)$$

The force coefficients, C_{mFD} and C_{mFV} , shall be determined from Tables 15.7-1 and 15.7-2, respectively, using values of effective damping determined in accordance with the following requirements:

For fundamental-mode response ($m = 1$) in the direction of interest, the coefficients, C_{IFD} and C_{IFV} , shall be based on the velocity exponent, α , that relates device force to damping device velocity. The effective fundamental-mode damping, shall be taken equal to the total effective damping of the fundamental mode less the hysteretic component of damping ($\beta_{1D} - \beta_{HD}$ or $\beta_{1M} - \beta_{HM}$) at the response level of interest ($\mu = \mu_D$ or $\mu = \mu_M$).

For higher-mode ($m > 1$) or residual-mode response in the direction of interest, the coefficients, C_{mFD} and C_{mFV} , shall be based on a value of α equal to 1.0. The effective modal damping shall be taken equal to the total effective damping of the mode of interest (β_{mD} or β_{mM}). For determination of the coefficient C_{mFD} , the ductility demand shall be taken equal to that of the fundamental mode ($\mu = \mu_D$ or $\mu = \mu_M$).

Table 15.7-1 Force Coefficient, C_{mFD} ^{a, b}

Effective Damping	$\mu \leq 1.0$				$C_{mFD} = 1.0^c$
	$\alpha \leq 0.25$	$\alpha = 0.5$	$\alpha = 0.75$	$\alpha \geq 1.0$	
≤ 0.05	1.00	1.00	1.00	1.00	$\mu \geq 1.0$
0.1	1.00	1.00	1.00	1.00	$\mu \geq 1.0$
0.2	1.00	0.95	0.94	0.93	$\mu \geq 1.1$
0.3	1.00	0.92	0.88	0.86	$\mu \geq 1.2$
0.4	1.00	0.88	0.81	0.78	$\mu \geq 1.3$
0.5	1.00	0.84	0.73	0.71	$\mu \geq 1.4$
0.6	1.00	0.79	0.64	0.64	$\mu \geq 1.6$
0.7	1.00	0.75	0.55	0.58	$\mu \geq 1.7$
0.8	1.00	0.70	0.50	0.53	$\mu \geq 1.9$
0.9	1.00	0.66	0.50	0.50	$\mu \geq 2.1$
≥ 1.0	1.00	0.62	0.50	0.50	$\mu \geq 2.2$

^a Unless analysis or test data support other values, the force coefficient C_{mFD} for visco-elastic systems shall be taken as 1.0.

^b Interpolation shall be used for intermediate values of velocity exponent α , and ductility demand, μ .

^c C_{mFD} shall be taken equal to 1.0 for values of ductility demand, μ , greater than or equal to the values shown.

Table 15.7-2 Force Coefficient, C_{mFV} ^{a, b}

Effective Damping	$\alpha \leq 0.25$	$\alpha = 0.5$	$\alpha = 0.75$	$\alpha \geq 1.0$
≤ 0.05	1.00	0.35	0.20	0.10
0.1	1.00	0.44	0.31	0.20
0.2	1.00	0.56	0.46	0.37
0.3	1.00	0.64	0.58	0.51
0.4	1.00	0.70	0.69	0.62
0.5	1.00	0.75	0.77	0.71
0.6	1.00	0.80	0.84	0.77
0.7	1.00	0.83	0.90	0.81
0.8	1.00	0.90	0.94	0.90
0.9	1.00	1.00	1.00	1.00
≥ 1.0	1.00	1.00	1.00	1.00

^a Unless analysis or test data support other values, the force coefficient C_{mFD} for visco-elastic systems shall be taken as 1.0.

^b Interpolation shall be used for intermediate values of velocity exponent, α .

15.7.3.4 Inelastic response limits. Elements of the damping system may exceed strength limits for design loads provided it is shown by analysis or test that:

1. Inelastic response does not adversely affect damping system function.
2. Element forces calculated in accordance with Sec. 15.7.3.3, using a value of Ω_0 , taken equal to 1.0, do not exceed the strength required to satisfy the load combinations of Sec. 4.2.2.1.

15.8 DESIGN REVIEW

A design review of the damping system and related test programs shall be performed by an independent team of registered design professionals in the appropriate disciplines and others experienced in seismic analysis methods and the theory of energy dissipation systems.

The design review shall include, but need not be limited to, the following:

1. Review of site-specific seismic criteria including the development of the site-specific spectra and ground motion histories and all other design criteria developed specifically for the project;
2. Review of the preliminary design of the seismic-force-resisting system and the damping system, including design parameters of damping devices;
3. Review of the final design of the seismic-force-resisting system and the damping system and all supporting analyses; and
4. Review of damping device test requirements, device manufacturing quality control and assurance, and scheduled maintenance and inspection requirements.

15.9 TESTING

The force-velocity-displacement and damping properties used for the design of the damping system shall be based on the prototype tests as specified in this section.

The fabrication and quality control procedures used for all prototype and production damping devices shall be identical.

15.9.1 Prototype tests

The following tests shall be performed separately on two full-size damping devices of each type and size used in the design, in the order listed below.

Representative sizes of each type of device may be used for prototype testing, provided both of the following conditions are met:

1. All pertinent testing and other damping device data are made available to, and are accepted by the registered design professional responsible for the design of the structure.
2. The registered design professional substantiates the similarity of the damping device to previously tested devices.

Test specimens shall not be used for construction, unless they are accepted by the registered design professional responsible for design of the structure and meet the requirements for prototype and production tests.

15.9.1.1 Data recording. The force-deflection relationship for each cycle of each test shall be recorded.

15.9.1.2 Sequence and cycles of testing. For the following test sequences, each damping device shall be subjected to gravity load effects and thermal environments representative of the installed condition. For seismic testing, the displacement in the devices calculated for the maximum considered earthquake, termed herein as the maximum earthquake device displacement, shall be used.

1. Each damping device shall be subjected to the number of cycles expected in the design windstorm, but not less than 2000 continuous fully reversed cycles of wind load. Wind load shall be at

amplitudes expected in the design wind storm, and applied at a frequency equal to the inverse of the fundamental period of the building ($f_l = 1/T_l$).

Exception: Damping devices need not be subjected to these tests if they are not subject to wind-induced forces or displacements, or if the design wind force is less than the device yield or slip force.

2. Each damping device shall be loaded with 5 fully reversed, sinusoidal cycles at the maximum earthquake device displacement at a frequency equal to $1/T_{IM}$ as calculated in Sec. 15.4.2.5. Where the damping device characteristics vary with operating temperature, these tests shall be conducted at a minimum of 3 temperatures (minimum, ambient, and maximum) that bracket the range of operating temperatures.

Exception: Damping devices may be tested by alternative methods provided all of the following conditions are met:

- a. Alternative methods of testing are equivalent to the cyclic testing requirements of this section.
 - b. Alternative methods capture the dependence of the damping device response on ambient temperature, frequency of loading, and temperature rise during testing.
 - c. Alternative methods are accepted by the registered design professional responsible for the design of the structure.
3. If the force-deformation properties of the damping device at any displacement less than or equal the maximum earthquake device displacement change by more than 15 percent for changes in testing frequency from $1/T_{IM}$ to $2.5/T_l$, then the preceding tests shall also be performed at frequencies equal to $1/T_l$ and $2.5/T_l$.

If reduced-scale prototypes are used to qualify the rate dependent properties of damping devices, the reduced-scale prototypes should be of the same type and materials, and manufactured with the same processes and quality control procedures, as full-scale prototypes, and tested at a similitude-scaled frequency that represents the full-scale loading rates.

15.9.1.3 Testing similar devices. Damping devices need not be prototype tested provided that both of the following conditions are met:

1. All pertinent testing and other damping device data are made available to, and are accepted by the registered design professional responsible for the design of the structure.
2. The registered design professional substantiates the similarity of the damping device to previously tested devices.

15.9.1.4 Determination of force-velocity-displacement characteristics. The force-velocity-displacement characteristics of a damping device shall be based on the cyclic load and displacement tests of prototype devices specified above. Effective stiffness of a damping device shall be calculated for each cycle of deformation using equation 13.6-1.

15.9.1.5 Device adequacy. The performance of a prototype damping device shall be deemed adequate if all of the conditions listed below are satisfied. The 15-percent limits specified below may be increased by the registered design professional responsible for the design of the structure provided that the increased limit has been demonstrated by analysis not to have a deleterious effect on the response of the structure.

15.9.1.5.1 Displacement-dependent damping devices. The performance of the prototype displacement-dependent damping devices shall be deemed adequate if the following conditions, based on tests specified in Sec. 15.9.1.2, are satisfied:

1. For Test 1, no signs of damage including leakage, yielding, or breakage.
2. For Tests 2 and 3, the maximum force and minimum force at zero displacement for a damping device for any one cycle does not differ by more than 15 percent from the average maximum and minimum forces at zero displacement as calculated from all cycles in that test at a specific frequency and temperature.
3. For Tests 2 and 3, the maximum force and minimum force at maximum earthquake device displacement for a damping device for any one cycle does not differ by more than 15 percent from the average maximum and minimum forces at the maximum earthquake device displacement as calculated from all cycles in that test at a specific frequency and temperature.
4. For Tests 2 and 3, the area of hysteresis loop (E_{loop}) of a damping device for any one cycle does not differ by more than 15 percent from the average area of the hysteresis loop as calculated from all cycles in that test at a specific frequency and temperature.
5. The average maximum and minimum forces at zero displacement and maximum earthquake displacement, and the average area of the hysteresis loop (E_{loop}), calculated for each test in the sequence of Tests 2 and 3, shall not differ by more than 15 percent from the target values specified by the registered design professional responsible for the design of the structure.

15.9.1.5.1 Velocity-dependent damping devices. The performance of the prototype velocity-dependent damping devices shall be deemed adequate if the following conditions, based on tests specified in Sec. 15.9.1.2, are satisfied:

1. For Test 1, no signs of damage including leakage, yielding, or breakage.
2. For velocity-dependent damping devices with stiffness, the effective stiffness of a damping device in any one cycle of Tests 2 and 3 does not differ by more than 15 percent from the average effective stiffness as calculated from all cycles in that test at a specific frequency and temperature.
3. For Tests 2 and 3, the maximum force and minimum force at zero displacement for a damping device for any one cycle does not differ by more than 15 percent from the average maximum and minimum forces at zero displacement as calculated from all cycles in that test at a specific frequency and temperature.
4. For Tests 2 and 3, the area of hysteresis loop (E_{loop}) of a damping device for any one cycle does not differ by more than 15 percent from the average area of the hysteresis loop as calculated from all cycles in that test at a specific frequency and temperature.
5. The average maximum and minimum forces at zero displacement, effective stiffness (for damping devices with stiffness only), and average area of the hysteresis loop (E_{loop}) calculated for each test in the sequence of Tests 2 and 3, does not differ by more than 15 percent from the target values specified by the registered design professional responsible for the design of the structure.

15.9.2 Production testing. Prior to installation in a building, damping devices shall be tested to ensure that their force-velocity-displacement characteristics fall within the limits set by the registered design professional responsible for the design of the structure. The scope and frequency of the production-testing program shall be determined by the registered design professional responsible for the design of the structure.

Appendix A

DIFFERENCES BETWEEN THE 2000 AND THE 2003 EDITIONS OF THE *NEHRP RECOMMENDED PROVISIONS*

EDITORIAL AND ORGANIZATIONAL CHANGES

The 2003 *Provisions* and *Commentary* documents were developed in two phases. First, the 2000 Edition was thoroughly edited and reformatted to increase the usability of the documents and eliminate inconsistencies that had crept in over the years. This reformatted version was approved by the BSSC member organizations and became the base document used in the remainder of the update process. The marked up version of the 2000 *Provisions* contents presented at the end of this appendix shows the reformatting organizational changes made as well as those resulting from substantive proposals for change.

The 2003 PUC also worked closely with those developing the seismic requirements for ASCE 7. The goal was to begin to reduce the redundancy between the *Provisions* and ASCE 7. The longer term goal, which should be achieved as a result of the next *Provisions* update, is to fully integrate ASCE 7 as a reference standard in the *Provisions* and thereby eliminate duplications.

2003 CHAPTER 1, GENERAL PROVISIONS

The manner in which Seismic Design Category is determined in Sec. 1.4.1 has been clarified by the addition of an exception. Note that the Simplified Alternate Chapter 4 includes an explanation of how to determine SDC using that procedure.

Section 1.5.3 has been modified to replace the term “anchor” with the term “connector.” This section also has been broadened to apply to more than just the interface of walls to roofs or floors.

2003 CHAPTER 2, QUALITY ASSURANCE

The quality assurance requirements that appeared as Chapter 2 of the 2000 *Provisions* now appear as Chapter 3. Definitions have been added for “quality assurance,” “quality assurance plan,” and “quality control.”

2003 CHAPTER 3, GROUND MOTION

One of the most significant changes made for the 2003 edition affects the ground motion requirements. First, the spectral acceleration maps distributed in a separate packet with past editions now are reduced in number and size and appear in the 2003 *Provisions* volume. Further, the maps are based on the newest version of the U.S. Geological Survey’s hazard maps and long-period maps showing contours for up to a 16-sec period have been added to permit designers to take longer period, T_L , into account.

The site classification procedures have been clarified and commentary has been added on site class definitions and on the procedure used to classify a site (Sec. 3.5.1 and 3.5.2).

Provisions Sec. 3.4 has been revised to strengthen and make more explicit the requirements for site-specific determinations of earthquake ground motions and new text to support this section has been added to the *Commentary*.

2003 CHAPTER 4, STRUCTURAL DESIGN CRITERIA

The redundancy provisions have been substantially revised for the 2003 *Provisions* to both simplify the calculation effort and to provide provisions that result in requirements that are more consistent with observed performance. Some minor modifications were made to the *R* factor table to provide for more consistency with respect to nonductile systems and dual systems. The base shear equations have been modified to take into account the new long-period ground motion maps, to adjust the minimum base shear value, and to refine the requirements for when the near-source equations are to be used. The *P*-delta and nonlinear static pushover analysis requirements have been modified to take into account recent research results.

An alternate chapter has been prepared to provide simplified design procedures for a specific class of structure. Low-rise buildings that are regular in plan and consist of “rigid” vertical seismic force-resisting systems may be designed using this alternative procedure, which significantly simplifies the design process.

2003 CHAPTER 5, STRUCTURAL ANALYSIS PROCEDURE

Revisions were made to Sec. 5.6 to clarify that the provisions of this section to determine soil-structure-interaction effects on design earthquake forces and displacements should not be used if foundation springs are incorporated in the analysis to directly model soil-structure interaction effects.

2003 CHAPTER 6, ARCHITECTURAL, MECHANICAL, AND ELECTRICAL COMPONENTS

The provisions for anchorage have been modified to reflect the current state of practice. New requirements for fire sprinkler system bracing and a new performance-based design approach for piping have been added for the 2003 edition. Also added are design provisions for long-period components. Requirements for suspended components have been updated and requirements concerning direction of loading have been clarified.

2003 CHAPTER 7, FOUNDATION DESIGN REQUIREMENTS

New in the 2003 edition are provisions and commentary covering the geotechnical ultimate strength design of foundations as a proposed replacement for allowable stress design. These procedures appear as an appendix to Chapter 7 to provide for trial use and evaluation prior to incorporation in the main text of the *Provisions*.

Also new in the 2003 edition are provisions and commentary concerning the modeling of the load-deformation characteristics of the foundation-soil system (“foundation stiffness”) using soil springs. Linear springs are addressed in the main text of the *Provisions* whereas nonlinear springs are treated in an appendix.

Supplemental provisions and commentary have been added for minimum longitudinal reinforcement requirements for uncased concrete piles, piles in a group containing both batter and vertical piles, and steel H piles.

The provisions mandating assessments of seismically induced geohazards in Seismic Design Categories (SDC) C, D, E, and F have been modified to waive these requirements when the authority having jurisdiction determines that sufficient information is available for nearby sites to evaluate the hazard for the proposed construction. Commentary text describing methods for geohazards assessments has been updated and guidance added on hazard screening and determination of earthquake magnitude.

2003 CHAPTER 8, STEEL STRUCTURE DESIGN REQUIREMENTS

Changes made for the 2003 edition include reference to the 2002 edition of the AISC Seismic Provisions and other updated standards.

New provisions and commentary have been added to address buckling restrained braced frames (BRBF). This system, initially developed in Japan and now gaining widespread use in areas of high seismicity in the United States, provides for highly ductile bracing elements in concentrically braced frames. Also included are new provisions and commentary to address special steel plate walls. This system, which has been included in the National Building Code of Canada for a number of years based on research conducted both in the United States and Canada, is gaining some limited use in areas of high seismicity in the United States. The system provides for ductile thin steel plate wall elements.

Table 4.3-1 has been updated to better define the requirements for the design of steel intermediate moment, ordinary moment, and ordinary concentrically braced frame systems.

2003 CHAPTER 9, CONCRETE STRUCTURE DESIGN REQUIREMENTS

Adoption of ACI 318-02 has permitted the elimination of many of the definitions and notations that were included in the 2000 *Provisions* as well as the deletion of provisions related to precast gravity load systems, emulation design of seismic-force-resisting precast frame and wall systems, non-emulative design of special moment frames constructed using precast concrete, precast concrete connections, anchor bolts in the top of columns, and most of the provisions related to anchoring to concrete.

Since ACI 318-02 includes a new type of seismic-force-resisting system termed an intermediate precast structural wall, R , Ω_o , and C_d values were added for that system as well as for ordinary precast shear wall systems. Intermediate precast shear wall systems are permitted as seismic-force-resisting systems in SDC D, E and F provided the building height does not exceed 40ft. There are no height limitations on that system for SDC B and C. Ordinary precast shear wall systems are allowed as seismic-force-resisting systems in SDC B only. Tilt-up concrete walls are interpreted in accordance with ACI 318 as precast shear walls and provisions are also introduced for wall piers and segments for intermediate precast structural walls that parallel those of the 2000 *Provisions* for wall piers and segments for special structural walls. Wall piers in both special and intermediate walls are required to be designed as columns if their horizontal length to thickness ratio is less than 2.5. Finally, it is specified that special reinforced concrete structural walls can be of either monolithic or precast construction so that the same R , Ω_o , and C_d apply for both types of construction.

New requirements were added for acceptance criteria and the validation testing of special precast structural walls that parallel those of ACI T1.1, *Acceptance Criteria for Moment Frames Based on*

Structural Testing. However, while the latter are applicable to both monolithic and precast frame construction, the new provisions are restricted to precast wall construction only.

2003 CHAPTER 10, STEEL AND CONCRETE STRUCTURE DESIGN REQUIREMENTS

Most of the requirements for composite structures appear in the reference standard, AISC Seismic Part II; thus, Chapter 10 is very brief and lists only modifications to this standard.

2003 CHAPTER 11, MASONRY STRUCTURE DESIGN REQUIREMENTS

Adoption of the 2002 Masonry Society Joint Committee (MSJC) standards, ACI530/ASCE 5/TMS402 and ACI 530.1/ASCE 6/TMS 602 stimulated a complete revision of Chapter 11. Additional changes were made in the reinforcement requirements for special moment frames.

2003 CHAPTER 12, WOOD STRUCTURE DESIGN REQUIREMENTS

In the 2003 *Provisions*, AF&PA's *ASD/LRFD Supplement Special Design Provisions for Wind and Seismic (AF&PA SDPWS)* and *AF&PA/ASCE 16 Load and Resistance Factor Design (LRFD) for Engineered Wood Construction* serve as the primary reference documents for engineered design provisions for wood. Adoption of *AF&PA SDPWS* permitted the deletion of significant portions of Chapter 12 and stimulated the revision of the material that remains.

A reference to the 2003 *International Residential Code* replaces the reference to the 1995 CABO *One- and Two-Family Dwelling Code*. Other basic requirements for conventional construction in Chapter 12 remain unchanged.

The wood design provisions also have been revised to address shear wall design and construction. The intent of the requirements concerning the sizing of hold-down devices has been clarified and extended to foundation shear anchorage. The equation format for calculating perforated shear wall capacity is introduced into the body of the *Provisions* allowing some efficiencies in determination of wall capacity relative to tabulated strength reduction factors. Guidance for shear wall and diaphragm deflection calculations also has been added as had commentary on the effect of framing moisture content on deflection calculations. Additional guidance also is provided to address constructability issues regarding slotted holes in large plate washers.

2003 CHAPTER 13, SEISMICALLY ISOLATED STRUCTURES DESIGN REQUIREMENTS

For the 2003 *Provisions*, provisions for the analysis and design of structures with damping systems move from an appendix to Chapter 13 to a new Chapter 15, "Structures with Damping Systems", and a short commentary is provided. A series of minor modifications to the 2000 text clarify the basic philosophy of the chapter to prevent erroneous calculations.

In Chapter 13 on seismically isolated structures, an exception on isolation systems without sufficient restoring force has been removed so that all isolation systems must have sufficient restoring force. A new requirement calling for variations in seismic isolator material properties due to aging, contamination, environmental exposure, loading rate, scragging and temperature to be considered in

analysis has been added while the requirement concerning the independence of isolation system behavior vis-à-vis application of the equivalent lateral force procedure has been deleted. Related changes have been made in the commentary text.

2003 CHAPTER 14, NONBUILDING STRUCTURE DESIGN REQUIREMENTS

For 2003 a new definition for nonbuilding structures similar to buildings has been added and the design coefficient table has been split into two tables to cover structures similar to buildings and structures not similar to buildings separately.

Table 14.2-2 has been separated into two tables for consistency with the definition. Furthermore, the path to the applicable design and detailing requirements in the other chapters and in Chapter 14 has been added to Tables 14.2-2 and the new Table 14.2-3.

Table 14.2-2 of the 2000 *Provisions* for nonbuilding structures similar to buildings prescribed R , Ω_o , and C_d values to be taken from Table 4.3-1, but prescribed less restrictive height limitations than those prescribed in Table 4.3-1. This inconsistency has been corrected. In addition, some nonbuilding structures similar to buildings are permitted with less restrictive height limitations if lower R values are used.

2003 CHAPTER 15, STRUCTURES WITH DAMPING SYSTEMS

See explanation above under Chapter 13.

**CHANGES IN SECTION NUMBERS BETWEEN THE
2000 AND 2003 EDITIONS PROVISIONS**

Chapter 1, GENERAL PROVISIONS

1.1 PURPOSE GENERAL

1.1.1 Purpose

1.1.2 Scope and application

1.1.3 References

1.1.4 Definitions

1.1.5 Notation

~~1.2 SCOPE AND APPLICATION~~

~~1.2.1 Scope~~

~~1.2.2 Additions~~

~~1.2.3 Change of Use~~

~~1.2.4 Alterations~~

~~1.2.5 Alternate Materials and Alternate Means and Methods of Construction~~

1.32 SEISMIC USE GROUPS

1.32.1 Seismic Use Group III

1.32.2 Seismic Use Group II

1.32.3 Seismic Use Group I

1.32.4 Multiple Use

1.32.5 Seismic Use Group III Structure Access Protection

1.43 OCCUPANCY IMPORTANCE FACTOR

1.4 SEISMIC DESIGN CATEGORY

1.4.1 Determination of Seismic Design Category

1.4.2 Site limitation for Seismic Design Categories E and F

1.5 SEISMIC DESIGN CATEGORY A

1.5.1 Lateral forces

1.5.2 Connections

1.5.3 Anchorage of concrete or masonry walls

1.5.4 Tanks assigned to Seismic use group III

Chapter 2, GLOSSARY AND NOTATIONS

~~2.1 GLOSSARY~~

~~2.2 NOTATIONS~~

Chapter 32, QUALITY ASSURANCE

32.1 SCOPE GENERAL

2.1.1 Scope

2.1.2 References

2.1.3 Definitions

2.1.4 Notation

~~32.2 QUALITY ASSURANCE~~

~~3.2.1 Details of Quality Assurance Plan~~

~~3.2.2 Contractor Responsibility~~

2.2 GENERAL REQUIREMENTS

- 2.2.1 Details of quality assurance plan
- 2.2.2 Contractor responsibility
- 32.3 SPECIAL INSPECTION
 - 32.3.1 Piers, Piles, Caissons
 - 32.3.2 Reinforcing Steel
 - 32.3.3 Structural Concrete
 - 32.3.4 Prestressed Concrete
 - 32.3.5 Structural Masonry
 - 32.3.6 Structural Steel
 - 32.3.7 Structural Wood
 - 32.3.8 Cold-Formed Steel Framing
 - 32.3.9 Architectural Components
 - 32.3.10 Mechanical and Electrical Components
 - 32.3.11 Seismic Isolation System
- 32.4 TESTING
 - 32.4.1 Reinforcing and Prestressing Steel
 - 32.4.2 Structural Concrete
 - 32.4.3 Structural Masonry
 - 32.4.4 Structural Steel
 - 32.4.5 Mechanical and Electrical Equipment
 - 32.4.6 Seismically Isolated Structures
- 32.5 STRUCTURAL OBSERVATIONS
- 32.6 REPORTING AND COMPLIANCE PROCEDURES

Chapter 43, GROUND MOTION

- ~~4.1 PROCEDURES FOR DETERMINING MAXIMUM CONSIDERED EARTHQUAKE AND DESIGN EARTHQUAKE GROUND MOTION ACCELERATIONS AND RESPONSE SPECTRA~~
 - ~~4.1.1 Maximum Considered Earthquake Ground Motions~~
 - ~~4.1.2 General Procedure for Determining Maximum Considered Earthquake and Design Spectral Response Accelerations~~
 - ~~4.1.3 Site Specific Procedure for Determining Ground Motion Accelerations~~
- ~~4.2 SEISMIC DESIGN CATEGORY~~
 - ~~4.2.1 Determination of Seismic Design Category~~
 - ~~4.2.2 Site Limitation for Seismic Design Categories E and F~~
- 3.1 GENERAL
 - 3.1.1 Scope
 - 3.1.2 References
 - 3.1.3 Definitions
 - 3.1.4 Notation
- 3.2 GENERAL REQUIREMENTS
 - 3.2.1 Site class
 - 3.2.2 Procedure selection
- 3.3 GENERAL PROCEDURE
 - 3.3.1 Mapped acceleration parameters
 - 3.3.2 Site coefficients and adjusted acceleration parameters
 - 3.3.3 Design acceleration parameters
 - 3.3.4 Design response spectrum
- 3.4 SITE SPECIFIC PROCEDURE
 - 3.4.1 Probabilistic maximum considered earthquake
 - 3.4.2 Deterministic maximum considered earthquake
 - 3.4.3 Site-specific maximum considered earthquake

3.4.4 Design response spectrum

3.5 SITE CLASSIFICATION FOR SEISMIC DESIGN

3.5.1 Site class definitions

Chapter 54, STRUCTURAL DESIGN CRITERIA

~~5.1 REFERENCE DOCUMENT~~

~~ASCE 7~~

~~5.2 DESIGN BASIS~~

~~5.2.1 General~~

~~5.2.2 Basic Seismic Force Resisting Systems~~

~~5.2.3 Structure Configuration~~

~~5.2.4 Redundancy~~

~~5.2.5 Analysis Procedures~~

~~5.2.6 Design and Detailing Requirements~~

~~5.2.7 Combination of Load Effects~~

~~5.2.8 Deflection and Drift Limits~~

~~5.3 INDEX FORCE ANALYSIS PROCEDURE~~

~~5.4 EQUIVALENT LATERAL FORCE PROCEDURE~~

~~5.4.1 Seismic Base Shear~~

~~5.4.2 Period Determination~~

~~5.4.3 Vertical Distribution of Seismic Forces~~

~~5.4.4 Horizontal Shear Distribution~~

~~5.4.5 Overturning~~

~~5.4.6 Drift Determination and *P*-Delta Effects~~

~~5.5 MODAL ANALYSIS PROCEDURE~~

~~5.5.1 Modeling~~

~~5.5.2 Modes~~

~~5.5.3 Modal Properties~~

~~5.5.4 Modal Base Shear~~

~~5.5.5 Modal Forces, Deflections, and Drifts~~

~~5.5.6 Modal Story Shears and Moments~~

~~5.5.7 Design Values~~

~~5.5.8 Horizontal Shear Distribution~~

~~5.5.9 Foundation Overturning~~

~~5.5.10 *P*-Delta Effects~~

~~5.6 LINEAR RESPONSE HISTORY ANALYSIS PROCEDURE~~

~~5.6.1 Modeling~~

~~5.6.2 Ground Motion~~

~~5.6.3 Response Parameters~~

~~5.7 NONLINEAR RESPONSE HISTORY ANALYSIS PROCEDURE~~

~~5.7.1 Modeling~~

~~5.7.2 Ground Motion and Other Loading~~

~~5.7.3 Response Parameters~~

~~5.7.4 Design Review~~

~~5.8 SOIL STRUCTURE INTERACTION EFFECTS~~

~~5.8.1 General~~

~~5.8.2 Equivalent Lateral Force Procedure~~

~~5.8.3 Modal Analysis Procedure~~

~~4.1 GENERAL~~

~~4.1.1 Scope~~

~~4.1.2 References~~

- 4.1.3 Definitions
- 4.1.4 Notation
- 4.2 GENERAL REQUIREMENTS
- 4.2.1 Design basis
- 4.2.2 Combination of load effects
- 4.3 SEISMIC-FORCE-RESISTING SYSTEM
- 4.3.1 Selection and limitations
- 4.3.2 Configuration
- 4.3.3 Redundancy
- 4.4 STRUCTURAL ANALYSIS
- 4.4.1 Procedure selection
- 4.4.2 Application of loading
- 4.5 DEFORMATION REQUIREMENTS
- 4.5.1 Deflection and drift limits
- 4.5.2 Seismic Design Categories B and C
- 4.5.3 Seismic Design Categories D, E, and F
- 4.6 DESIGN AND DETAILING REQUIREMENTS
- 4.6.1 Seismic design Category B
- 4.6.2 Seismic design Category C
- 4.6.3 Seismic Design Category D, E, and F

ALTERNATIVE SIMPLIFIED CHAPTER 4

Chapter 5 STRUCTURAL ANALYSIS PROCEDURES

- 5.1 GENERAL
- 5.1.1 Scope
- 5.1.2 Definitions
- 5.1.3 Notation
- 5.2 EQUIVALENT LATERAL FORCE PROCEDURE
- 5.2.1 Seismic base shear
- 5.2.2 Period determination
- 5.2.3 Vertical distribution of seismic forces
- 5.2.4 Horizontal shear distribution
- 5.2.5 Overturning
- 5.2.6 Drift determination and P-delta effects
- 5.3 RESPONSE SPECTRUM PROCEDURE
- 5.3.1 Modeling
- 5.3.2 Modes
- 5.3.3 Modal properties
- 5.3.4 Modal base shear
- 5.3.5 Modal forces, deflections and drifts
- 5.3.6 Modal story shears and moments
- 5.3.7 Design values
- 5.3.8 Horizontal shear distribution
- 5.3.9 Foundation overturning
- 5.3.10 P-delta effects
- 5.4 LINEAR RESPONSE HISTORY PROCEDURE
- 5.4.1 Modeling
- 5.4.2 Ground motion
- 5.4.3 Response parameters
- 5.5 NONLINEAR RESPONSE HISTORY PROCEDURE

5.5.1 Modeling

5.5.2 Ground motion and other loading

5.5.3 Response parameters

5.5.4 Design review

5.6 SOIL-STRUCTURE INTERACTION EFFECTS

5.6.1 General

5.6.2 Equivalent lateral force procedure

5.6.3 Response spectrum procedure

Appendix to Chapter 5, NONLINEAR STATIC ANALYSIS

**Chapter 6, ARCHITECTURAL, MECHANICAL, AND ELECTRICAL COMPONENTS
DESIGN REQUIREMENTS**

6.1 GENERAL

~~6.1.1 References and Standards~~

~~ASME A17.1~~

~~ASTM C635~~

~~ASME/BPV~~

~~ASTM C636~~

~~ANSI/ASME B31.1~~

~~ANSI/ASME B31.3~~

~~ANSI/ASME B31.4~~

~~ANSI/ASME B31.5~~

~~ANSI/ASME B31.9~~

~~ANSI/ASME B31.11~~

~~ANSI/ASME B31.8~~

~~NFPA 13~~

~~IEEE 344~~

~~ASHRAE SRD~~

~~CISCA Rees for Zones 0-2~~

~~CISCA Rees for Zones 3-4~~

~~SMACNA HVAC~~

~~SMACNA Rectangular~~

~~SMACNA Restraint~~

~~AAMA 501.4~~

6.1.1 Scope

6.1.2 References

6.1.3 Definitions

6.1.4 Notation

6.2 GENERAL DESIGN REQUIREMENTS

~~6.1.2.1 Component Force Transfer~~ Seismic Design Category

~~6.1.2.2 Seismic Forces~~ Component Importance Factor

~~6.1.2.3 Seismic Relative Displacements~~ Consequential damage

~~6.1.2.4 Component Importance Factor~~ Flexibility

6.2.5 Component force transfer

6.2.6 Seismic forces

6.2.7 Seismic relative displacements

~~6.1.2.8~~ Component Anchorage

~~6.1.2.9~~ Construction Documents

6.2.3 ARCHITECTURAL COMPONENT DESIGN

~~6.2.1~~ General

- ~~6.2.2-3.1~~ Architectural Component Forces and Displacements
- ~~6.2.33.2~~ Architectural Component Deformation
- ~~6.2.43.3~~ Exterior Nonstructural Wall Elements and Connections
- ~~6.2.53.3~~ Out-of-Plane Bending
- ~~6.2.63.4~~ Suspended Ceilings
- ~~6.2.73.5~~ Access Floors
- ~~6.2.83.6~~ Partitions
- ~~6.3.7~~ General
- ~~6.2.9~~ ~~Steel Storage Racks~~
- ~~6.2.103.8~~ Glass in Glazed Curtain Walls, Glazed Storefronts, and Glazed Partitions
- ~~6.34~~ MECHANICAL AND ELECTRICAL COMPONENT DESIGN
- ~~6.34.1~~ ~~General~~ Component period
- ~~6.34.2~~ Mechanical and Electrical Component Forces and Displacements
- ~~6.34.3~~ Mechanical and Electrical Component Period
- ~~6.3.4~~ Mechanical and Electrical Component Attachments
- ~~6.3.54.4~~ Component Supports and attachments
- ~~6.3.6~~ ~~Component Certification~~
- ~~6.3.74.5~~ Utility and Service Lines at Structure Interfaces
- ~~6.3.8~~ ~~Site Specific Considerations~~
- ~~6.3.9~~ ~~Storage Tanks~~
- ~~6.3.104.6~~ HVAC Ductwork
- ~~6.3.114.7~~ Piping Systems
- ~~6.3.124.8~~ Boilers and Pressure Vessels
- ~~6.3.13~~ Mechanical Equipment Attachments, and Supports
- ~~6.3.14~~ Electrical Equipment Attachments, and Supports
- ~~6.3.15~~ ~~Alternative Seismic Qualification Methods~~
- ~~6.3.164.9~~ Elevator Design Requirements

Appendix to Chapter 6, ALTERNATIVE PROVISIONS FOR THE DESIGN OF PIPING SYSTEMS

Chapter 7, FOUNDATION DESIGN REQUIREMENTS

- 7.1 GENERAL
 - 7.1.1 Scope
 - 7.1.2 References
 - 7.1.3 Definitions
 - 7.1.4 Notation
- ~~7.2~~ ~~STRENGTH OF COMPONENTS AND FOUNDATIONS~~ General Design Requirements
 - ~~7.2.1~~ ~~Structural Materials~~ Foundation components
 - 7.2.2 Soil Capacities
 - 7.2.3 Foundation load-deformation characteristics
- 7.3 SEISMIC DESIGN CATEGORIES A AND B
- 7.4 SEISMIC DESIGN CATEGORY C
 - 7.4.1 Investigation
 - 7.4.2 Pole-Type Structures
 - 7.4.3 Foundation Ties
 - 7.4.4 Special Pile Requirements
- 7.5 SEISMIC DESIGN CATEGORIES D, E, AND F
 - 7.5.1 Investigation

- 7.5.2 Foundation Ties
- 7.5.3 Liquefaction Potential and Soil Strength Loss
- 7.5.4 Special Pile and Grade Beam Requirements

Appendix to Chapter 7, GEOTECHNICAL ULTIMATE STRENGTH DESIGN
OF FOUNDATIONS AND FOUNDATION LOAD-DEFORMATION
MODELING

Chapter 8, STEEL STRUCTURE DESIGN REQUIREMENTS

8.1 REFERENCE DOCUMENTS—GENERAL

- ~~AISC LRFD~~
- ~~AISC ASD~~
- ~~AISC Seismic~~
- ~~AISI~~
- ~~ANSI/ASCE 8-90~~
- ~~SJI~~
- ~~ASCE 19~~

8.1.1 Scope

8.1.2 References

8.1.3 Definitions

8.1.4 Notation

8.2 SEISMIC REQUIREMENTS FOR STEEL STRUCTURES GENERAL DESIGN REQUIREMENTS

8.2.1 Seismic Design Categories B and C

8.2.2 Seismic Design categories D, E, and F

8.3 SEISMIC DESIGN CATEGORIES A, B, AND C STRUCTURAL STEEL

8.3.1 Material properties for determination of required strength

~~8.4 SEISMIC DESIGN CATEGORIES D, E, AND F~~

~~8.4.1 Modifications to AISC Seismic~~

8.5 4 COLD-FORMED STEEL SEISMIC REQUIREMENTS

8.4.1 Modifications to references

8.4.2 Light-frame walls

8.4.3 Prescriptive framing

8.4.4 Steel deck diaphragms

~~8.5.1 Modifications to AISI~~

~~8.5.2 Modifications to ANSI/ASCE 8-90~~

~~8.6 LIGHT FRAMED WALLS~~

~~8.6.1 Boundary Members~~

~~8.6.2 Connections~~

~~8.6.3 Braced Bay Members~~

~~8.6.4 Diagonal Braces~~

~~8.6.5 Shear Walls~~

~~8.7 SEISMIC REQUIREMENTS FOR STEEL DECK DIAPHRAGMS~~

8.8 5 STEEL CABLES

**8.6 RECOMMENDED PROVISIONS FOR BUCKLING-RESTRAINED
BRACED FRAMES**

8.6.1 Symbols

8.6.2 Glossary

8.6.3 Buckling-restrained braced frames (BRBF)

**8.7 RECOMMENDED PROVISIONS FOR SPECIAL STEEL PLATE
WALLS**

8.7.1 Symbols

8.7.2 Glossary

8.7.3 Scope

8.7.4 Webs

8.7.5 Connections of webs to boundary elements

8.7.6 Horizontal and vertical boundary elements (HBE and VBE)

Chapter 9, CONCRETE STRUCTURE DESIGN REQUIREMENTS

9.1 REFERENCE DOCUMENTS GENERAL

~~ACI 318~~

~~ACI ITG/T1.1~~

~~ASME B1.1~~

~~ASME B18.2.1~~

~~ASME B18.2.6.9~~

~~ATC 24~~

~~9.1.1 Modifications to ACI 318 Ref. 9-1 Scope~~

~~9.1.2 References~~

~~9.1.3 General definitions~~

9.2 ~~ANCHORING TO CONCRETE~~ GENERAL DESIGN REQUIREMENTS

~~9.2.1 Scope~~

~~9.2.2 Notations and Definitions~~

~~9.2.3 General Requirements~~

~~9.2.4 General Requirements for Strength of Structural Anchors~~

~~9.2.5 Design Requirements for Tensile Loading~~

~~9.2.6 Design Requirements for Shear Loading~~

~~9.2.7 Interaction of Tensile and Shear Forces~~

~~9.2.8 Required Edge Distances, Spacings, and Thicknesses to Preclude Splitting Failure~~

~~9.2.9 Installation of Anchors~~

~~9.2.1 Classification of shear walls~~

~~9.2.2 Modifications to ACI 318~~

9.3 ~~CLASSIFICATION OF SHEAR WALLS~~

~~9.3.1 Ordinary Plain Concrete Shear Walls~~

~~9.3.2 Detailed Plain Concrete Shear Walls~~

9.4 ~~SEISMIC DESIGN CATEGORY A~~

9.5 ~~SEISMIC DESIGN CATEGORY B~~

~~9.5.1 Ordinary Moment Frames~~

9.6 ~~SEISMIC DESIGN CATEGORY C~~

~~9.6.1 Seismic Force Resisting Systems~~

~~9.6.2 Discontinuous Members~~

~~9.4.1 Classification of shear walls~~

~~9.6.3.2 Plain Concrete~~

~~9.6.4 Anchor Bolts in the Tops of Columns~~

9.7 ~~SEISMIC DESIGN CATEGORIES D, E, OR F~~

~~9.7.1 Seismic Force Resisting Systems~~

~~9.7.2 Frame Members Not Proportioned to Resist Forces Induced by Earthquake Motions~~

9.6 ACCEPTANCE CRITERIA FOR SPECIAL PRECAST STRUCTURAL

WALLS BASED ON VALIDATION TESTING

9.6.1 Notation

9.6.2 Definitions

9.6.3 Scope and general requirements

9.6.4 Design procedure

9.6.5 Test modules

9.6.6 Testing agency

9.6.7 Test method

9.6.8 Test report

9.6.9 Test module acceptance criteria

9.6.10 Reference

Appendix to Chapter 9, REINFORCED CONCRETE DIAPHRAGMS CONSTRUCTED USING
UNTOPPED PRECAST CONCRETE ELEMENTS

Chapter 10, STEEL AND CONCRETE STRUCTURE DESIGN REQUIREMENTS

10.1 ~~REFERENCE DOCUMENTS~~ GENERAL

~~ACI 318~~

~~AISC/LRFD~~

~~AISC Seismic~~

~~AISI~~

10.1.1 Scope

10.1.2 References

10.1.3 Definitions

10.1.4 Notation

10.2 GENERAL DESIGN REQUIREMENTS

10.3 SEISMIC DESIGN CATEGORIES B AND C

10.4 SEISMIC DESIGN CATEGORIES D, E, AND F

10.5 MODIFICATIONS TO AISC SEISMIC, PART II

10.5.1 Changes to nomenclature

10.5.2 Changes to definitions in the AISC Glossary

10.5.3 Changes to section 1-SCOPE

10.5.4 Changes to Section 2 – REFERENCED SPECIFICATIONS,
CODES AND STANDARDS

10.5.5 Changes to Section 3 – SEISMIC DESIGN CATEGORIES

10.5.6 Changes to Section 4 – LOADS, LOAD COMBINATIONS
AND NOMINAL STRENGTHS

10.5.7 Changes to Section 5.2 – Concrete and steel reinforcement

10.5.8 Changes to Section 6.3 - COMPOSITE BEAMS

10.5.9 Changes to Section 6.4 – Reinforced-Concrete-Encased
Composite Columns

10.5.10 Changes to Section 6.4a – Ordinary Seismic System
Requirements

10.5.11 Changes to Section 6.5 – CONCRETE-FILLED COMPOSITE
COLUMNS

10.5.12 Changes to Section 6.5a – CONCRETE-FILLED COMPOSITE
COLUMNS

10.5.13 Changes to Section 7.3 – NOMINAL STRENGTH OF
CONNECTIONS

10.5.14 Changes to Section 8.2 – COLUMNS

10.5.15 Changes to Section 8.3 – COMPOSITE BEAMS

10.5.16 Changes to Section 8.4 – Partially Restrained (PR) Moment
Connections

10.5.17 Changes to Section 9.3 – BEAMS

- 10.5.18 Changes to Section 9.4 – MOMENT CONNECTIONS
- 10.5.19 Changes to Section 9.5 – COLUMN-BEAM MOMENT RATIO
- 10.5.20 Changes to Section 10.2 – COLUMNS
- 10.5.21 Changes to Section 10.4 – MOMENT CONNECTIONS
- 10.5.22 Changes to Section 11.4 – MOMENT CONNECTIONS
- 10.5.23 Changes to Section 12.4 – BRACES
- 10.5.24 Changes Title for Section 15.3
- 10.5.25 Changes Title for Section 16.3
- 10.5.26 Add New Section 15.4
- 10.5.27 Add New Section 16.4

Chapter 11, MASONRY STRUCTURE DESIGN REQUIREMENTS

11.1 GENERAL

11.1.1 Scope

11.1.2 Reference Documents

ACI 318

ACI 530

ACI 530.1

~~11.1.3 Definitions~~

~~11.1.4 Notations~~

~~11.2 CONSTRUCTION REQUIREMENTS~~

~~11.2.1 General~~

~~11.2.2 Quality Assurance~~

11.3 GENERAL DESIGN REQUIREMENTS

~~11.3.1 Scope~~

~~11.3.2 Empirical Masonry Design~~

~~11.3.3 Plain (Unreinforced) Masonry Design~~

~~11.3.4 Reinforced Masonry Design~~

~~11.3.5 Seismic Design Category A~~

~~11.3.6 Seismic Design Category B~~

~~11.3.7 Seismic Design Category C~~

~~11.3.8 Seismic Design Category D~~

~~11.3.9 Seismic Design Categories E and F~~

~~11.3.10 Properties of Materials~~

~~11.3.11 Section Properties~~

~~11.3.12 Headed and Bent Bar Anchor Bolts~~

11.2.1 Classification of shear walls

11.2.2 Modifications to ACI 530/ADCE 5/TMS 402 and ACI 530.1/ASCE 5/TMS 602

~~11.4 DETAILS OF REINFORCEMENT~~

~~11.4.1 General~~

~~11.4.2 Size of Reinforcement~~

~~11.4.3 Placement Limits for Reinforcement~~

~~11.4.4 Cover for Reinforcement~~

~~11.4.5 Development of Reinforcement~~

~~11.5 STRENGTH AND DEFORMATION REQUIREMENTS~~

~~11.5.1 General~~

~~11.5.2 Required Strength~~

~~11.5.3 Design Strength~~

~~11.5.4 Deformation Requirements~~

~~11.6 FLEXURE AND AXIAL LOADS~~

~~11.6.1 Scope~~

~~11.6.2 Design Requirements of Reinforced Masonry Members~~

~~11.6.3 Design of Plain (Unreinforced) Masonry Members~~

~~11.7 SHEAR~~

~~11.7.1 Scope~~

~~11.7.2 Shear Strength~~

~~11.7.3 Design of Reinforced Masonry Members~~

~~11.7.4 Design of Plain (Unreinforced) Masonry Members~~

~~11.8 SPECIAL REQUIREMENTS FOR BEAMS~~

~~11.9 SPECIAL REQUIREMENTS FOR COLUMNS~~

~~11.10 SPECIAL REQUIREMENTS FOR SHEAR WALLS~~

~~11.10.1 Ordinary Plain Masonry Shear Walls~~

~~11.10.2 Detailed Plain Masonry Shear Walls~~

~~11.10.3 Ordinary Reinforced Masonry Shear Walls~~

~~11.10.4 Intermediate Reinforced Masonry Shear Walls~~

~~11.10.5 Special Reinforced Masonry Shear Walls~~

~~11.10.6 Flanged Shear Walls~~

~~11.10.7 Coupled Shear Walls~~

~~11.113 SPECIAL MOMENT FRAMES OF MASONRY~~

~~11.113.1 Calculation of Required Strength~~

~~11.113.2 Flexural Yielding~~

~~11.3.3 Materials~~

~~11.113.34 Reinforcement~~

~~11.113.4 5 Wall Frame Beams~~

~~11.113.5 6 Wall Frame Columns~~

~~11.113.67 Wall Frame Beam-Column Intersection~~

~~11.124 GLASS-UNIT MASONRY AND MASONRY VENEER~~

~~11.124.1 Design Lateral Forces and Displacements~~

~~11.124.2 Glass-Unit Masonry Design~~

~~11.124.3 Masonry Veneer Design~~

~~11.5 PRESTRESSED MASONRY~~

Chapter 12, WOOD STRUCTURE DESIGN REQUIREMENTS

12.1 GENERAL

12.1.1 Scope

12.1.2 Reference Documents

ASCE 16

APA Y510T

APA N375B

APA E315H

CABO Code

NFoPA T903

PS20

ANSI/AITC A190.1

ASTM D5055-95A

PS-1

PS-2

ANSI 05.1

ANSI A208.1

~~AWPA C1, 2, 2, 3, 9, 28~~

12.1.3 Definitions

~~12.1.34 Notations~~

12.2 DESIGN METHODS

~~12.2.1 Engineered Wood Design~~

~~12.2.2 Conventional Light Frame Construction~~

12.2.1 Seismic design categories B, C, and D

12.2.2 Seismic design Categories E and F

12.2.3 Modifications to AF&PA SDPWS for Seismic Design

Categories B, C, and D

12.2.4 Modifications to AF&PA SDPWS for Seismic Design

Categories E, and F

12.3 GENERAL DESIGN REQUIREMENTS FOR ENGINEERED WOOD CONSTRUCTION

~~12.3.1 General~~

~~12.3.2 Shear Resistance Based on Principles of Mechanics~~

~~12.3.3 Deformation Compatibility Requirements~~

12.3.4 Framing Requirements

~~12.3.5 Sheathing Requirements~~

~~12.3.6 Wood Members Resisting Horizontal Seismic Forces Contributed by Masonry and Concrete~~

~~12.4 DIAPHRAGMS AND SHEAR WALLS~~

~~12.4.1 Diaphragms~~

~~12.4.2 Shear Walls~~

~~12.4.3 Perforated Shear Walls~~

12.5 CONVENTIONAL LIGHT-FRAME CONSTRUCTION

~~12.5.1 Scope Limitations~~

12.5.2 Braced Walls

12.5.3 Detailing Requirements

~~12.6 SEISMIC DESIGN CATEGORY A~~

~~12.7 SEISMIC DESIGN CATEGORIES B, C, AND D~~

~~12.7.1 Conventional Light Frame Construction~~

~~12.7.2 Engineered Construction~~

~~12.8 SEISMIC DESIGN CATEGORIES E AND F~~

~~12.8.1 Limitations~~

Chapter 13, SEISMICALLY ISOLATED STRUCTURES DESIGN REQUIREMENTS

13.1 GENERAL

13.1.1 Scope

13.1.2 Definitions

13.1.3 Notation

~~13.2 CRITERIA SELECTION~~

~~13.2.1 Basis for Design~~

~~13.2.2 Stability of the Isolation System~~

~~13.2.3 Seismic Use Group~~

~~13.2.4 Configuration Requirements~~

~~13.2.5 Selection of Lateral Response Procedure~~

13.2 GENERAL DESIGN REQUIREMENTS

13.2.1 Occupancy importance factor

13.2.2 Configuration

13.2.3 Ground motion

13.2.4 Procedure selection

13.2.5 Isolation system

13.2.6 Structural system

13.2.7 Elements of structures and nonstructural components

~~13.3 EQUIVALENT LATERAL FORCE PROCEDURE~~

~~13.3.1 General~~

~~13.3.2₁ Deformation Characteristics of the Isolation System~~

~~13.3.3₂ Minimum Lateral Displacements~~

~~13.3.4₃ Minimum Lateral Forces~~

~~13.3.5₄ Vertical Distribution of Force~~

~~13.3.6₅ Drift Limits~~

~~13.4 DYNAMIC LATERAL RESPONSE PROCEDURE~~

~~13.4.1 General Modeling~~

~~13.4.2 Isolation System and Structural Elements Below the Isolation System Description of procedures~~

~~13.4.3 Structural Elements Above the Isolation System Minimum lateral displacements and forces~~

~~13.4.4 Ground Motion Drift limits~~

~~13.4.5 Mathematical Model~~

~~13.4.6 Description of Analysis Procedures~~

~~13.4.7 Design Lateral Force~~

~~13.5 LATERAL LOAD ON ELEMENTS OF STRUCTURES AND NONSTRUCTURAL COMPONENTS SUPPORTED BY BUILDINGS DESIGN REVIEW~~

~~13.5.1 General~~

~~13.5.2 Forces and Displacements~~

~~13.6 DETAILED SYSTEM REQUIREMENTS~~

~~13.6.1 General~~

~~13.6.2 Isolation System~~

~~13.6.3 Structural System~~

~~13.7 FOUNDATIONS~~

~~13.8 DESIGN AND CONSTRUCTION REVIEW~~

~~13.8.1 General~~

~~13.8.2 Isolation System~~

~~13.9 REQUIRED TESTS OF THE ISOLATION SYSTEM TESTING~~

~~13.9.1 General~~

~~13.9.2.6.1 Prototype Tests~~

~~13.9.36.2 Determination of Force-Deflection Characteristics~~

~~13.9.46.3 Test Specimen Adequacy~~

~~13.9.56.4 Design Properties of the Isolation System~~

~~Appendix to Chapter 13, STRUCTURES WITH DAMPING SYSTEMS~~

Chapter 14, NONBUILDING STRUCTURE DESIGN REQUIREMENTS

14.1 GENERAL

14.1.1 Scope

14.1.2 References

14.1.3 Definitions

14.1.4 Notation

14.1.5 Nonbuilding structures supported by other structures

~~14.2 REFERENCES~~

~~14.3 INDUSTRY DESIGN STANDARDS AND RECOMMENDED PRACTICE~~

~~14.4 NONBUILDING STRUCTURES SUPPORTED BY OTHER STRUCTURES~~

~~14.4.1 Architectural, Mechanical, and Electrical Components~~

~~14.5 2 STRUCTURAL GENERAL DESIGN REQUIREMENTS~~

~~14.5.1 Design Basis~~

~~14.5.2 Rigid Nonbuilding Structures~~

~~14.5.3 Loads~~

~~14.5.4 Fundamental Period~~

~~14.5.5 Drift Limitations~~

~~14.5.6 Materials Requirements~~

~~14.5.7 Deflection Limits and Structure Separation~~

~~14.5.8 Site Specific Response Spectra~~

14.2.1 Seismic Use groups and importance factors

14.2.2 Ground motion

14.2.3 Design basis

14.2.4 Seismic-force-resisting system selection and limitations

14.2.5 Structural analysis procedure selection

14.2.6 Seismic weight

14.2.7 Rigid nonbuilding structures

14.2.8 Minimum base shear

14.2.9 Fundamental period

14.2.10 Vertical distribution of seismic forces

14.2.11 Deformation requirements

14.2.12 Nonbuilding structure classification

~~14.6 3 NONBUILDING STRUCTURES SIMILAR TO BUILDINGS~~

~~14.6.3 1 General Electrical Power Generating Facilities~~

~~14.6.3.2 Pipe Racks Structural Towers for Tanks and Vessels~~

~~14.6.3.3 Steel Storage Racks Piers and Wharves~~

~~14.6.3.4 Electrical Power Generating Facilities Pipe Racks~~

~~14.6.3.5 Structural Towers for Tanks and Vessels Steel Storage Racks~~

~~14.6.6 Piers and Wharves~~

~~14.7 NONBUILDING STRUCTURES NOT SIMILAR TO BUILDINGS~~

~~14.7.1 General~~

~~14.7.2 Earth Retaining Structures~~

~~14.7.3 Tanks and Vessels Stacks and Chimneys~~

~~14.7.4 Stacks and Chimneys Amusement Structures~~

~~14.7.5 Amusement Structures Special Hydraulic Structures~~

~~14.7.6 Special Hydraulic Structures Secondary Containment Systems~~

~~14.7.7 Secondary Containment Systems Tanks and Vessels~~

Appendix to Chapter 14 OTHER NONBUILDING STRUCTURES

Chapter 15 STRUCTURES WITH DAMPING SYSTEMS

15.1 GENERAL

15.1.1 Scope

15.1.2 Definitions

15.1.3 Notation

15.2 GENERAL DESIGN REQUIREMENTS

15.2.1 Seismic Design Category A

15.2.2 System requirements

15.2.3 Ground motion

15.2.4 Procedure selection

15.2.5 Damping system

15.3 NONLINEAR PROCEDURES

15.3.1 Nonlinear response history procedure

15.3.2 Nonlinear static procedure

15.4 RESPONSE SPECTRUM PROCEDURE

15.4.1 Modeling

15.4.2 Seismic-force-resisting system

15.4.3 Damping system

15.5 EQUIVALENT LATERAL FORCE PROCEDURE

15.5.1 Modeling

15.5.2 Seismic-force-resisting system

15.5.3 Damping system

15.6 DAMPED RESPONSE MODIFICATION

15.6.1 Damping coefficient

15.6.2 Effective damping

15.6.3 Effective ductility demand

15.6.4 Maximum effective ductility demand

15.7 SEISMIC LOAD CONDITIONS AND ACCEPTANCE CRITERIA

15.7.1 Nonlinear procedures

15.7.2 Seismic-force-resisting system

15.7.3 Damping system

15.8 DESIGN REVIEW

15.9 TESTING

15.9.1 Prototype tests

15.9.2 Production testing

Appendix B

PARTICIPANTS IN THE BSSC 2003 *PROVISIONS* UPDATE PROGRAM

2001 BSSC BOARD OF DIRECTION

Chair

Charles Thornton, Ph.D., PE, The Thornton P Tomasetti Group, Inc., New York, New York

Vice Chair

S. K. Ghosh, Ph.D., S. K. Ghosh Associates, Inc., Northbrook, Illinois (representing the Portland Cement Association)

Secretary

Charles Carter, PE, American Institute of Steel Construction, Chicago, Illinois

Ex Officio

William W. Stewart, FAIA, Stewart-Schaberg Architects, Clayton, Missouri

Members

J. Gregg Borchelt, PE, Brick Institute of America, Reston, Virginia

Bradford K. Douglas, PE, American Forest and Paper Association, Washington, D.C.

Edwin Dean, PE, SE, Nishkian Dean, Portland, Oregon (representing the Applied Technology Council)

Henry Green, Bureau of Construction Codes, State of Michigan Department of Consumer and Industry Services, Okemos, Michigan (representing the National Institute of Building Sciences)

H. S. Lew, Ph.D., PE, National Institute of Standards and Technology, Gaithersburg, Maryland (representing the Interagency Committee for Seismic Safety in Construction)

Joseph Nicoletti, PE, URS/John A. Blume and Associates, San Francisco, California (representing the Earthquake Engineering Research Institute)

James Rinner, Turner Construction, Dixon, California (representing the Association General Contractors of America)

James Rossberg, PE, American Society of Civil Engineers, Reston, Virginia

Jeffrey Sciaudone, PE, Institute for Building and Home Safety, Tampa, Florida

W. Lee Shoemaker, Ph.D., Metal Building Manufacturers Association, Cleveland, Ohio

Howard Simpson, Sc.D., P.E., Simpson, Gumpertz and Heger, Arlington, Massachusetts (representing the National Council of Structural Engineers Associations)

Charles Spitz, NCARB, AIA, CSI, Architect/Planner Code Consultant, Wall, New Jersey (representing the American Institute of Architects)

David Wismer, PE, CBO, Department of Licenses and Inspections, Philadelphia, Pennsylvania (representing the Building Officials and Code Administrators International)

BSSC Staff

Claret M. Heider, NIBS Vice President, BSSC/MMC

Bernard F. Murphy, PE, Director, Special Projects

Carita Tanner, Editorial and Public Relations Manager

Patricia Blasi, Administrative Assistant

2002 BSSC BOARD OF DIRECTION

Chair

Charles Thornton, Ph.D., PE, The Thornton P Tomasetti Group, Inc., New York, New York

Vice Chair

S. K. Ghosh, Ph.D., S. K. Ghosh Associates, Inc., Northbrook, Illinois (representing the Portland Cement Association)

Secretary

Charles Carter, PE, American Institute of Steel Construction, Chicago, Illinois

Ex Officio

William W. Stewart, FAIA, Stewart-Schaberg Architects, Clayton, Missouri

Members

David R. Bonneville, PE, SE, Degenkolb Engineers, San Francisco (representing the EarthquakeEngineering Research Institute)

J. Gregg Borchelt, PE, Brick Institute of America, Reston, Virginia

Bradford K. Douglas, PE, American Forest and Paper Association, Washington, D.C.

Edwin Dean, PE, SE, Nishkian Dean, Portland, Oregon (representing the Applied Technology Council)

Henry Green, Bureau of Construction Codes, State of Michigan Department of Consumer and Industry Services, Okemos, Michigan (representing the National Institute of Building Sciences)

H. S. Lew, Ph.D., PE, National Institute of Standards and Technology, Gaithersburg, Maryland (representing the Interagency Committee for Seismic Safety in Construction)

James Rinner, Turner Construction, Dixon, California (representing the Associated General Contractors of America)

James Rossberg, PE, American Society of Civil Engineers, Reston, Virginia

Grover Lee Sawyer, Jr., PE, North Carolina Department of Insurance, Office of the State Fire Marshall, Raleigh (representing the International Code Council)

Jeffrey Sciaudone, PE, Institute for Building and Home Safety, Tampa, Florida

W. Lee Shoemaker, Ph.D., Metal Building Manufacturers Association, Cleveland, Ohio

Howard Simpson, Sc.D., P.E., Simpson, Gumpertz and Heger, Arlington, Massachusetts (representing the National Council of Structural Engineers Associations)

Charles Spitz, NCARB, AIA, CSI, Architect/Planner Code Consultant, Wall, New Jersey (representing the American Institute of Architects)

BSSC Staff

Claret M. Heider, NIBS Vice President, BSSC/MMC

Bernard Murphy, PE, Director, Special Projects

Carita Tanner, Communications and Public Relations Manager

Patricia Blasi, Administrative Assistant

2003 BSSC BOARD OF DIRECTION

Chairman

Charles Thornton, Chairman/Principal, Thornton-Tomasetti Group, Inc., New York, New York

Vice Chairman

David Bonneville, Degenkolb Engineers, San Francisco, California

Secretary

Charles Carter, Chief Structural Engineer, American Institute of Steel Construction, Chicago, Illinois

Ex-Officio

William W. Stewart, Stewart-Schaberg Architects, Clayton, Missouri (representing the American Institute of Architects)

Members

J. Gregg Borchelt, Vice President, Brick Industry Association, Reston, Virginia

Edwin Dean, Nishkian Dean, Portland, Oregon

Bradford K. Douglas, Director of Engineering, American Forest and Paper Association, Washington, D.C.

Henry Green, Executive Director, Bureau of Construction Codes and Fire Safety, State of Michigan, Department of Labor and Economic Growth, Lansing, Michigan (representing the National Institute of Building Sciences)

H.S. Lew, Senior Research Engineer, National Institute of Standards and Technology, Gaithersburg, Maryland (representing Interagency Committee on Seismic Safety in Construction)

Joseph Messersmith, Coordinating Manager, Regional Code Services, Portland Cement Association, Rockville, Virginia (representing the Portland Cement Association)

Jim Rinner, Project Manager II, Kitchell CEM, Sacramento, California

James Rossberg, Manager, Technical Activities for the Structural Engineering Institute, American Society of Civil Engineers, Reston Virginia

Jeffery Sciadone, Associate Director, of Engineering, Institute of Business and Home Safety, Tampa, Florida

W. Lee Shoemaker, Director, Engineering and Research, Metal Building Manufacturers Association, Cleveland, Ohio

Howard Simpson, Simpson Gumpertz and Heger, Arlington, Massachusetts (representing National Council of Structural Engineers Associations)

Charles A. Spitz, Architect/Planner/Code Consultant, Wall New Jersey (representing the American Institute of Architects)

BSSC STAFF

Claret M. Heider, Vice President for BSSC Programs

Bernard F. Murphy, Director, Special Projects

Carita Tanner, Communications/Public Relations Manager

Patricia Blasi, Administrative Assistant

2003 PROVISIONS UPDATE COMMITTEE

Chair

Ronald O. Hamburger, Simpson Gumpertz and Heger, San Francisco, California

Representing Technical Subcommittee 1, Design Mapping

C. B. Crouse, URS Corporation, Seattle, Washington

R. Joe Hunt, BWXT Y-12, LLC, Oak Ridge, Tennessee

E. V. Leyendecker, U.S. Geological Survey, Denver, Colorado

Representing Technical Subcommittee 2, Design Criteria and Analysis

John D. Hooper, Magnusson Klemencic, Seattle, Washington

James R. Harris, J. R. Harris and Company, Denver, Colorado

Charles Kircher, Charles Kircher and Associates Consulting Engineers, Palo Alto, California

Representing Technical Subcommittee 3, Foundations and Geotechnical Considerations

Maurice S. Power, Geomatrix Consultants, Oakland, California

Roger Borchardt, U.S. Geological Survey, Menlo Park, California

Representing Technical Subcommittee 4, Concrete Structures

Neil Hawkins, Professor Emeritus, University of Illinois, Clyde Hill, Washington

Joseph J. Messersmith, Regional Code Services, Portland Cement Association, Rockville, Virginia

Jack P. Moehle, Pacific Earthquake Engineering Research Center, Richmond, California

Representing Technical Subcommittee 5, Masonry Structures

Daniel Shapiro, SOHA Engineers, San Francisco, California

Daniel P. Abrams, MAE Center, University of Illinois, Urbana

Jason J. Thompson, National Concrete Masonry Association, Herndon, Virginia

Representing Technical Subcommittee 6, Steel Structures

James O. Malley, Degenkolb Engineers, San Francisco, California

Harry W. Martin, American Iron and Steel Institute, Auburn, California

C. Mark Saunders, Rutherford and Chekene, Oakland, California

Representing Technical Subcommittee 7, Wood Structures

Philip Line, American Forest and Paper Association, Washington, D.C.

James E. Russell, Building Code Consultant, Concord, California

Erol Karacabeyli, Forintek Canada Corporation, Vancouver, British Columbia, Canada

Representing Technical Subcommittee 8, Mechanical/Electrical Systems and Building Equipment and Architectural Elements

John D. Gillengerten, Office of Statewide Health and Planning and Development, Sacramento, California

Pat Lama, Mason Industries, Hauppauge, New York

John F. Silva, Hilti Incorporated, San Rafael, California

Representing Technical Subcommittee 9, Quality Assurance

Douglas M. Smits, Division of Building Inspections, City of Charleston, South Carolina

Jim W. Sealy, Jim W. Sealy/Architect/Consultant, Dallas, Texas

Representing Technical Subcommittee 10, Low Rise and Residential Structures

J. Daniel Dolan, Washington State University, Pullman, Washington

Representing Technical Subcommittee 11, Composite Steel and Concrete Structures

Roberto T. Leon, Georgia Institute of Technology, Atlanta, Georgia

Jerome Hajjar, University of Minnesota, Minneapolis, Minnesota

Representing Technical Subcommittee 12, Base Isolation and Energy Dissipation

Michael Constantinou, University at Buffalo, State University of New York, Buffalo

Martin Johnson, ABS Consulting, Irvine, California

Representing Technical Subcommittee 13, Nonbuilding Structures

Stephen W. Meier, Tank Industry Consultants, Indianapolis, Indiana

John T. Hutton, Uzun and Case Engineers, Atlanta, Georgia

Richard Drake, J.S. Dyer and Associates, Irvine, California

Gayle Johnson, Han-Padron Associates, Oakland, California

Harold Sprague, Structural Engineer, Black and Veatch, Overland Park, Kansas

At-Large Member

Ed Sutton, National Association of Home Builders, Washington, D.C.

Robert McCluer, International Code Council, Country Club Hills, Illinois

Bonnie Manley, National Fire and Protection Association, Quincy, Massachusetts

Dominic Kelly, Simpson Gumpetz and Heger, Waltham, Massachusetts

Robert E. Bachman, Consulting Structural Engineer, Westlake Village, California

Ex-officio Voting Member

William T. Holmes, Rutherford and Chekene, Oakland, California

PUC TECHNICAL SUBCOMMITTEES

Technical Subcommittee 1, DESIGN MAPPING

Chair

C.B. Crouse, URS Corporation, Seattle, Washington

Members

Roger Borchardt, U.S. Geological Survey, Menlo Park, California

R. Joe Hunt, BWXT Y-12, LLC, Oak Ridge, Tennessee

Jeffrey K. Kimball, Engineering and Operations Support, U.S. Department of Energy, Germantown, Maryland

E.V. Leyendecker, U.S. Geological Survey, Denver, Colorado

Lance Manuel, University of Texas, Austin, Texas

Walter Silva, Pacific Engineering Analysis, El Cerrito, California

Paul G. Somerville, Woodward-Clyde Federal Services, Pasadena, California

Eugene L. Trahern, Coughlin Porter Lundeen, Seattle, Washington

Michael Valley, Magnusson Klemencic, Seattle, Washington

Corresponding Members

Nathan Gould, ABS Consulting, St Louis, Missouri

Richard McConnell, Consultant, Springfield, Virginia

Technical Subcommittee 2, DESIGN CRITERIA AND ANALYSIS

Chair

John D. Hooper, Magnusson Klemencic, Seattle, Washington

Members

Mark Ascheim, University of Illinois, Urban, Illinois

James R. Harris, J.R. Harris and Company, Denver, Colorado

Charles Kircher, Charles Kircher and Associates Consulting Engineers, Palo Alto, California

Richard J. Phillips, Martin and HBL, Los Angeles, California

Chia-Ming Uang, University of California, La Jolla, California

Corresponding Members

David Bonowitz, San Francisco, California

David Bonneville, Degenkolb Engineers, San Francisco, California

Finley Charney, Virginia Polytechnic Institute and State University, Blacksburg, Virginia

Gary Y.K. Chock, Martin and Chock, Honolulu, Hawaii
Anil K. Chopa, University of California, Berkeley, California
Mohammed M. Ettouney, Wedlinger Associates, New York, New York
Andrew Gayer, ABS Consulting, St. Louis, Missouri
S.K. Ghosh, S.K. Ghosh Associates, Palatine, Illinois
John D. Gilengerten, OSHPD, Facilities Development Division, Sacramento, California
Nathan Gould, ABS Consulting, St Louis, Missouri
Walter B. Grossman, Structural Consultant, Fairlawn, New Jersey
Ronald Hamburger, Simpson Gumpertz and Heger, San Francisco, California
Husein Hasan, Tennessee Valley Authority, Knoxville, Tennessee
William T. Holmes, Rutherford and Chekene Engineers, Oakland, California
John T. Hutton, Uzun and Case Engineers, Atlanta, Georgia
Marcelino Iglesias, Department of Community Development, Trenton, New Jersey
Robert I. Johnson, R.I. Johnson and Associates, Wheaton, Illinois
Leonard Joseph, Thornton-Tomasetti Engineers, New York, New York
Ghassem Khosrownia, U.S. Army Corps of Engineers, Sacramento, California
Uno Kula, Phoenix, Arizona
Philip Line, American Forest and Paper Association, Washington, D.C.
Joe Maffei, Rutherford and Chekene Consulting Engineers, Oakland, California
Scott E. Maxwell, Consulting Engineer, Ypsilanti, Michigan
Richard D. McConnell, Consultant, Springfield, Virginia
Vilas Mujumdar, National Science Foundation, Arlington, Virginia
Paul Murray, Structural Design Group, Nashville, Tennessee
Simin Naseeh, SEAoNC, San Francisco, California
Mark Pierepiekarz, MRP Engineering, Newcastle, Washington
David Pierson, ARW Engineers, Ogden, Utah
Andrei M. Reinhorn, State University of New York, Buffalo, New York
Frederick C. Schmitt, Consulting Civil Engineer, West Chester, Pennsylvania
Gary R. Searer, Wiss, Janney, Elstner Associates, Emeryville, California
John G. Shipp, EQE International, Irvine, California
Thomas, D. Skaggs, APA-The Engineered Wood Association, Tacoma, Washington
Itzhak Tepper, American Structural Engineers, Alexandria, Virginia
Jason Thompson, National Concrete Masonry Association, Herndon, Virginia
Fred M. Turner, Seismic Safety Commission, Sacramento, California

Michael Valley, Magnusson Klemencic, Seattle, Washington

Ed Wang, CH2M Hill, St. Louis, Missouri

Tom C. Xia, DCI Engineers, Bellevue, Washington

Howard Zee, ARUP, San Francisco, California

Technical Subcommittee 3, FOUNDATIONS AND GEOTECHNICAL CONSIDERATIONS

Chair

Maurice S. Power, Geomatrix Consultants, San Francisco, California

Members

Donald G. Anderson, CH2M Hill, Bellevue, Washington

David Bonowitz, Consultant, San Francisco, California

Roger D. Borchardt, U.S. Geological Survey, Menlo Park, California

Craig Comartin, Comartin-Reis, Stockton, California

Ricardo Dobry, Rensselaer Polytechnic Institute, Troy, New York

Tom H. Hale, California Office of Statewide Health Planning and Development, Sacramento, California

Jeffrey R. Keaton, AMEC Earth and Environmental, Anaheim, California

Geoffrey R. Martin, University of Southern California, Los Angeles, California

Farhang Ostadan, Bechtel Corporation, San Francisco, California

Edward E. Rinne, Kleinfelder, Oakland, California

Jonathan P. Stewart, University of California, Los Angeles

Corresponding Members

Susan W. Chang, Shannon & Wilson, Seattle, Washington

Paul L. Cloke, Science Applications International Corporation, Las Vegas, Nevada

C.B. Crouse, URS Corporation, Seattle, Washington

Husein Hasan, Tennessee Valley Authority, Knoxville, Tennessee

Neil M. Hawkins, University of Illinois, Urbana

Klaus H. Jacob, Lamont Doherty Earth Observatory of Columbia University, Palisades, New York

Dominic Kelly, Simpson Gumpertz & Heger, Waltham, Massachusetts

Jeffrey K. Kimball, U.S. Department of Energy, Germantown, Maryland

Cetin Soydemir, Geotechnical Services, Goffstown, New Hampshire

Steven A. Wendland, GeoSystems Engineering, Lenexa, Kansas

Tom C. Xia, DCI Engineers, Bellevue, Washington

T. Leslie Youd, Brigham Young University, Provo, Utah

Technical Subcommittee 4, CONCRETE STRUCTURES

Chair

Neil M. Hawkins, University of Illinois, Urbana

Members:

David E. Arndt, KPFF Consulting Engineers, Seattle, Washington

Ned M. Cleland, Blue Ridge Design, Winchester, Virginia

W. Gene Corley, Construction Technology Laboratories, Skokie, Illinois

S. K. Ghosh, S.K. Ghosh Associates, Northbrook, Illinois

David P. Gustafson, Concrete Reinforcing Steel Institute, Schaumburg, Illinois

Marcelino Iglesias, Department of Community Development, Trenton, New Jersey

H. S. Lew, National Institute of Standards and Technology, Gaithersburg, Maryland

Rene W. Luft, Simpson Gumpertz & Heger, San Francisco, California

Joe Maffei, Rutherford & Chekene Consulting Engineers, Oakland, California

Joseph J. Messersmith, Jr., Portland Cement Association, Rockville, Virginia

Jack P. Moehle, Pacific Earthquake Engineering Research Center, Richmond, California

Richard Wollmershauser, Hilti, Tulsa, Oklahoma

Sharon L. Wood, University of Texas, Austin

Corresponding Members:

Leo Argiris, Arup & Partners, New York, New York

Nathan Gould, ABS Consulting, St. Louis, Missouri

Mervyn Kowalsky, North Carolina State University, Raleigh, North Carolina

Scott E. Maxwell, Consulting Engineer, Ypsilanti, Michigan

Antonio Nanni, University of Missouri, Rolla, Missouri

John F. Silva, Hilti, San Rafael, California

Scott Tinker, EQE International, Seattle, Washington

Tom C. Xia, DCI Engineers, Bellvue, Washington

Technical Subcommittee 5, MASONRY STRUCTURES

Chair

Daniel Shapiro, SOH and Associates, Structural Engineers, San Francisco, California

Members

Daniel P. Abrams, University of Illinois MAE Center, Urbana

Randall P. Bernhardt, Burns & McDonnell, St. Louis, Missouri

J. Gregg Borchelt, Brick Industry Association, Reston, Virginia

Robert Chittendon, DSA, Granite Bay, California

Richard E. Klingner, University of Texas, Austin

Vilas Mujumdar, National Science Foundation, Arlington, Virginia

Max L. Porter, Department of Civil Engineering, Iowa State University, Ames

James R. Tauby, Mason Industries, Smithtown, New York

Jason J. Thompson, National Concrete Masonry Association, Herndon, Virginia

Terence A. Weigel, Department of Civil Engineering, University of Louisville, Kentucky

Corresponding Members

Dean D. Brown, Interstate Brick Company, West Jordan, Utah

Thomas A. Gangel, Wallace Engineering Structural Consultants, Tulsa, Oklahoma

S.K. Ghosh, S.K. Ghosh Associates, Palatine, Illinois

Marcelino Iglesias, Department of Community Development, Trenton, New Jersey

Eric N. Johnson, Brick Association of the Carolinas, Charlotte, North Carolina

Dilip Khatri, Khatri International, Pasadena, California

Laura Larson, Durant, Au Clair, Wisconsin

Scott Maxwell, Consulting Engineer, Ypsilanti, Michigan

Richard Silva, National Park Service, Lakewood, Colorado

Simin Naseeh, Structural Engineers Association of Northern California, San Francisco, California

Arturo E. Schultz, University of Minnesota, Minneapolis

John Tawresey, KPFF Consulting Engineers, Seattle, Washington

Diane Throop, Consultant, Cincinnati, Ohio

Technical Subcommittee 6, STEEL STRUCTURES

Chair

James O. Malley, Degenkolb Engineers, San Francisco, California

Members

Michel Bruneau, MCEER, State University of New York, Buffalo

Richard M. Drake, J.S. Dyer & Associates, Irvine, California

Harry W. Martin, American Iron and Steel Institute, Auburn, California

Clarkson W. Pinkham, S. B. Barnes Associates, Los Angeles, California

C. Mark Saunders, Rutherford and Chekene, San Francisco, California

W. Lee Shoemaker, Metal Building Manufacturers Association, Cleveland, Ohio

Bozidar Stojadinovic, University of California, Berkeley

Kurt D. Swensson, KSI Structural Engineers, Atlanta, Georgia

Chia-Ming Uang, University of California

Corresponding Members:

Leo Argiris, Arup & Partners, New York, New York

Hassan Astaneh, University of California at Berkeley

Michael Cochran, Brian L. Cochran Associates, Los Angeles, California

Andrew Gayer, ABS Consulting, St. Louis, Missouri

Subhash C. Goel, University of Michigan, Ann Arbor

Nathan Gould, ABS Consulting, St. Louis, Missouri

John L. Gross, National Institute of Standards and Technology, Gaithersburg, Maryland

Y. Henry Huang, Los Angeles County Department of Public Works, Alhambra, California

Marcelino Iglesias, Department of Community Development, Trenton, New Jersey

Ghassem Khosrownia, U.S. Army Corps of Engineers, Sacramento, California

Cynthia Duncan, AISC, Chicago, Illinois

Terry R. Lundeen, Coughlin Porter Lundeen, Seattle, Washington

Robert T. Lyons, Brandow & Johnston Associates, Los Angeles, California

Paul C. Perrin, Burgess & Niple, Ltd., Cincinnati, Ohio

David L. Pierson, ARW Engineers, Ogden, Utah

Steven M. Thomas, Butler Construction, Kansas City, Missouri

James R. Thomas, Delich, Roth & Goodwillie, P.A., Kansas City, Missouri

Tom C. Xia, DCI Engineers, Bellvue, Washington

Technical Subcommittee 7, WOOD STRUCTURES

Chair

Philip Line, American Forest and Paper Association, Washington, D.C.

Members

Kelly Cobeen, Cobeen & Associates Structural Engineering, Lafayette, California

Vladimir Kochkin, National Association of Home Builders Research Center, Upper Marlboro, Maryland

J. Daniel Dolan, Washington State University, Pullman, Washington

Erol Karacabeyli, Forintek Canada Corporation, Vancouver, British Columbia, Canada

James A. Mahaney, Wiss, Janney, Elstner Associates, Emeryville, California

Frank K. H. Park, Guilford County Planning and Development, Greensboro, North Carolina

Steven E. Pryor, Simpson Strong-Tie, Dublin, California

James E. Russell, Consultant, Concord, California

Thomas D. Skaggs, APA - The Engineered Wood Association, Tacoma, Washington

Chuck Williams, CWA Consultants, Sammamish, Washington

Corresponding Members

Philip R. Brazil, Reid Middleton, Everett, Washington

Kevin C. K. Cheung, Western Wood Products Association, Portland, Oregon

John M. Coil, Thornton-Tomasetti, Cole & Walsh, Tustin, California

Jay Crandell, Applied Residential Engineering Associates, West River, Maryland

Thomas M. Corcoran, Carter-Burgess, Kirkland, Washington

Andre Filiatrault, University of California, San Diego

Robert S. George, Architect, San Bruno, California

Greg Gilda, EQE International, Seattle, Washington

Robert W. Glowinski, American Forest and Paper Association, Washington, DC

Zeno Martin, APA- The Engineered Wood Association, Tacoma, Washington

Gary L. Mochizuki, Structural Solutions, Walnut Creek, California

Rawn Nelson, R.F. Nelson and Associates, Hermosa Beach, California

Douglas Rammer, USDA Forest Products Laboratory, Madison, Wisconsin

Mike Rhodebeck, USP Lumber Connectors, Gambier, Ohio

Alan Robinson, Tuan and Robinson Structural Engineers, San Francisco, California

David V. Rosowsky, Oregon State University, Corvallis, Oregon

Stephen P. Schneider, Kramer-Gehlen and Associates, Vancouver, Washington

Douglas M. Smith, City of Charleston, South Carolina

Victor L. Taugher, Taugher and Associates, Castro Valley, California

David P. Tyree, American Forest and Paper Association, Colorado Springs, Colorado

Dennis S. Wish, Professional Engineer, La Quinta, California

Edwin G. Zacher, H.J. Brunnier and Associates, San Francisco, California

**Technical Subcommittee 8, MECHANICAL/ELECTRICAL SYSTEMS AND BUILDING
EQUIPMENT AND ARCHITECTURAL ELEMENTS**

Chair

John D. Gillengerten, Office of Statewide Health Planning and Development, Sacramento, California

Members

George Antaki, WSRC – Savannah Site, Aiken, South Carolina

Robert E. Bachman, Consulting Structural Engineer, Sacramento, California

Richard A. Behr, Pennsylvania State University, University Park, Pennsylvania

Russell Fleming, National Fire Sprinkler Association, Patterson, New York

Ronald W. Haupt, Pressure Piping Engineering Associates, Foster City, California

Y. Henry Huang, Los Angeles County Department of Public Works, Alhambra, California

Pat Lama, Mason Industries, Hauppauge, New York

John V. Loscheider, Loscheider Engineering Company, Renton, Washington

David A. Sheppard, Consulting Structural Engineer, Sonoma, California

John F. Silva, Hilti, San Rafael, California

William W. Stewart, Stewart-Schaberg/Architects, Clayton, Missouri

Corresponding Members

Leo Argiris, Arup & Partners, New York, New York

Victor D. Azzi, Rack Manufacturers Institute, Rye, New Hampshire

Antonio Braga, FM Global, Woodland Hills, California

James A. Carlson, Fort Calhoun Station, Fort Calhoun, Nebraska

Paul J. Carrafa, Property Maintenance Specialists, Willingboro, New Jersey

Christian Dubay, National Fire Protection Association, Quincy, Massachusetts

Mohammed M. Ettouney, Weidlinger Associates, New York, New York

Joseph R. Hetzel, Door & Access Systems Manufacturers, Cleveland, Ohio

John T. Hutton, Lockwood Greene Engineers, Atlanta, Georgia

Marcelino Iglesias, Department of Community Development, Trenton, New Jersey

Brian Kehoe, Consultant, Emeryville, California

Paul Meisel, Kinetics Noise Control, Dublin, Ohio

Antonio Nanni, University of Missouri, Rolla

Richard J. Phillips, Martin & HBL, Los Angeles, California

Mark R. Pierepiekarz, MRP Engineering, Newcastle, Washington

John "Jack" Prosek, Turner Construction Company, San Jose, California

Robert Simmons, Amber/Booth, Houston, Texas

Jean Smith, Schindler Elevator Corporation, Morristown, New Jersey

William Staehlin, Division of State Architect, Sacramento, California

Victoria Valentine, National Fire Sprinkler Association, Patterson, New York

Michael E. Werner, County of St. Louis, Missouri

Richard Wollmershauser, Hilti, Tulsa, Oklahoma

Maryann Phipps, ESTRUCTURE, El Cerrito, California

Technical Subcommittee 9, QUALITY ASSURANCE

Chair

Douglas M. Smits, City of Charleston, South Carolina

Members

Mark Kluver, Portland Cement Association, San Ramon, California

John Loscheider, Loscheider Engineering Company, Renton, Washington

Jim W. Sealy, Jim W. Sealy/Architect/Consultant, Dallas, Texas

Charles A. Spitz, Architect/Planner/Code Consultant, Wall, New Jersey

Corresponding Members

Michael Constantinou, State University of New York, Buffalo

Neil Hawkins, Consultant, Clyde Hill, Washington

Roberto T. Leon, Georgia Institute of Technology, Atlanta, Georgia

Philip Line, American Forest and Paper Association, Washington, DC

James O. Malley, Degenkolb Engineers, San Francisco, California

R. William McNealy, McNealy-Burnberry Engineering, St. Louis, Missouri

Vilas Mujumdar, National Science Foundation, Arlington, Virginia

Daniel Shapiro, SOHA Engineers, San Francisco, California

Ed Sutton, National Association of Home Builders, Washington, DC

James R. Thomas, Delich, Roth and Goodwillie, P.A., Kansas City, Missouri

Fred M. Turner, California Seismic Safety Commission, Sacramento, California

Technical Subcommittee 10, RESIDENTIAL AND LOW RISE STRUCTURES

Chair

J. Daniel Dolan, Washington State University, Pullman, Washington

Members

Mark Caldwell, Apex Engineering, Calvert City, Kentucky

Chip Clark, Brick Industry Association, Reston, Virginia

James R. Harris, J.R. Harris & Company, Denver, Colorado

Eric N. Johnson, Brick Association of the Carolinas, Charlotte, North Carolina

Joseph J. Messersmith, Portland Cement Association, Rockville, Virginia

Jim W. Sealy, Architect, Dallas, Texas

Lee Shoemaker, Metal Building Manufacturers Association, Cleveland, Ohio

David P. Tyree, American Forest and Paper Association, Colorado Springs, Colorado

Terence A. Weigel, University of Louisville, Kentucky

Robert J. Wills, American Iron & Steel Institute, Birmingham, Alabama

Sharon, L. Wood, University of Texas, Austin

Corresponding Members

S.K. Ghosh, S.K. Ghosh Associates, Palatine, Illinois

Wassem Khan, Brick Industry Association, Reston, Virginia

Ed Sutton, National Association of Home Builders, Washington, DC

Technical Subcommittee 11, COMPOSITE STEEL AND CONCRETE STRUCTURES

Chair

Roberto T. Leon, School of Civil and Environmental Engineering, Georgia Institute of Technology, Atlanta

Members

Jerome F. Hajjar, University of Minnesota, Minneapolis

Kevin LeSmith, Magnusson Klemencic, Seattle, Washington

Clarkson W. Pinkham, S. B. Barnes Associates, Los Angeles, California

Bahram M. Sharooz, University of Cincinnati, Ohio

Kurt D. Swenson, KSI Structural Engineers, Atlanta, Georgia

Corresponding Members

Scott A. Civjan, University of Massachusetts, Amherst

Greg Deierlein, Stanford University, Palo Alto, California

Subhash Goel, University of Michigan, Ann Arbor

Larry Griffis, Walter P. Moore and Associates, Austin, Texas

Neil Hawkins, Consultant, Clyde Hill, Washington

Technical Subcommittee 12, BASE ISOLATION AND ENERGY DISSIPATION

Chair

Michael Constantinou, Department of Civil, Structural and Environmental Engineering, University at Buffalo, State University of New York, Buffalo, New York

Members

Tom H. Hale, Office of Statewide Health Planning and Development, Sacramento, California

Robert D. Hanson, Federal Emergency Management Agency, Pasadena, California

Saif Hussain, SHA Coffman Engineers, Encino, California

Martin W. Johnson, ABS Consulting, Irvine, California

Charles Kircher, Charles Kircher & Associates Consulting Engineers, Palo Alto, California

Kit Miyamoto, Marr Chatter & Miyamoto, West Sacramento, California

Andrew Whittaker, Department of Civil, Structural and Environmental Engineering, University at Buffalo, State University of New York, Buffalo, New York

Corresponding Members

Ian Aiken, Seismic Isolation Engineering, Piedmont, California

Amarnath Kasalanati, DIS, Inc., Lafayette, California

Wenshen Pong, San Francisco State University, California

Mark Sinclair, Degenkolb Engineers, San Francisco, California

John Stewart, Rimkus Consulting Group, Atlanta, Georgia

Andrew W. Taylor, KPFF Consulting Engineers, Seattle, Washington

Jack Wiggins, EQE International, Seattle, Washington

Technical Subcommittee 13, NONBUILDING STRUCTURES

Chair

Stephen W. Meier, Tank Industry Consultants, Indianapolis, Indiana

Members

Wafic T. Ayoub, Specialized Engineering Services, Overland Park, Kansas

Robert E. Bachman, Consulting Structural Engineer, Sacramento, California

Richard M Drake, J.S. Dyer & Associates, Irvine, California

Robert M. Ebeling, U.S. Army Engineer Research and Development Center, Vicksburg, Mississippi

Martin L. Eskijian, California State Land Commission, Long Beach, California

Douglas G. Honegger, D.G. Honegger Consulting, Arroyo Grande, California

John T. Hutton, Uzun & Case Engineers, Atlanta, Georgia

Gayle S. Johnson, Han-Padron Associates, Oakland, California

Leon Kempner, Jr., Bonneville Power Administration, Vancouver, Washington

Nicholas A. Legatos, Preload, Hauppauge, New York

Theodore, C. Lemoff, National Fire Protection Association International, Quincy, Massachusetts

Denis Radecki, Hamon Custodis, Brazil, Indiana

Carl Rivkin, National Fire Protection Association International, Quincy, Massachusetts

Harold Sprague, Black and Veatch Special Projects Corporation, Overland Park, Kansas

Corresponding Members

David K. Adams, Lane Engineers, Tulare, California

Scott Ashford, University of California, San Diego

Victor D. Azzi, Rack Manufacturers Institute, Rye, New Hampshire

Pete Carrato, Bechtel Corporation, Frederick, Maryland

Thomas Dahlgren, Ben E. Gerwick, San Francisco, California
John Ferrito, Consultant, Ventura, California
Henry Fong, Port of Long Beach, California
Donita K. Fredricks, Chicago Bridge and Iron, Clive, Iowa
Charles S. Hanskat, Hanskat and Associates, San Diego, California
Husein Hasan, Tennessee Valley Authority, Knoxville, Tennessee
Frank J. Hsiu, Chevron Texaco Research and Technology Company, Richmond, California
Jagadish Joshi, Westinghouse, Georgia
John V. Loscheider, Loscheider Engineering Company, Renton, Washington
Praveen K. Malhotra, Factory Mutual Research, Norwood, Massachusetts
Sanj Malhuste, Bechtel Corporation, Frederick, Maryland
Robert J. Masterson, RJM Associates, Fall River, Massachusetts
Anil Misra, University of Missouri, Kansas City
Douglas J. Nyman, D.J. Nyman & Associates, Houston, Texas
Rolf Pawski, Landmark Structures, Wheaton, Illinois
Bob Porthouse, Chimney Consultants, West Lebanon, New Hampshire
Anshel J. Schiff, Stanford University, Stanford, California
Jerry Serventi, Port of Oakland, California
John D. Stevenson, Stevenson & Associates, Cleveland, Ohio
Harry E. Stewart, Cornell University, Ithaca, New York
Warren Stewart, Han-Padron Associates, Long Beach, California
Eric K. Thorkildsen, Collins Engineering, East Greenbush, New York
Stuart D. Werner, Seismic Systems & Engineering Consultants, Oakland, California
Peter Yin, Port of Los Angeles, San Pedro, California

BSSC SIMPLIFIED DESIGN TASK GROUP

Chair

William T. Holmes, Rutherford & Chekene, Oakland, California

Members

Gary Y.K. Chock, Martin and Chock, Honolulu, Hawaii
Ronald O. Hamburger, Simpson Gumpertz and Heger, San Francisco, California
James R. Harris, J.R. Harris & Company, Denver, Colorado
John D. Hooper, Magnusson Klemencic, Seattle, Washington
Richard J. Phillips, Martin & HBL, Los Angeles, California

**REPRESENTATIVES OF BSSC MEMBER ORGANIZATIONS
AND THEIR ALTERNATES**

AFL-CIO Building and Construction Trades Department

Representative Pete Stafford, Center to Protect Workers' Rights, Washington, D.C.
Alternate None on Record

American Concrete Institute

Representative Shuaib H. Ahmed, American Concrete Institute, Farmington Hills, Michigan
Alternate None on Record

American Consulting Engineers Council

Representative Gregg E. Brandow, Brandow and Johnston Associates, Los Angeles, California
Alternate Edward Bajer, American Council of Engineering Companies, Washington, D.C.

American Forest and Paper Association

Representative David P. Tyree, American Forest and Paper Association, Colorado Springs, Colorado
Alternate Bradford K. Douglas, American Forest and Paper Association, Washington, D.C.

American Institute of Architects

Representative Charles A. Spitz, Architect/Planner/Code Consultant, Wall, New Jersey
Alternate Perry A. Haviland, Haviland Associates Architects, Oakland, California

American Institute of Steel Construction

Representative Charles J. Carter, American Institute of Steel Construction, Chicago, Illinois
Alternate Louis F. Geschwinder, American Institute of Steel Construction, Chicago, Illinois

American Iron and Steel Institute

Representative Harry W. Martin, American Iron and Steel Institute, Auburn, California
Alternate None on Record

American Society of Civil Engineers

Representative James A. Rossberg, American Society of Civil Engineers, Reston, Virginia
Alternate Douglas E. Honegger, Consultant, Arroyo Grande, California

American Society of Civil Engineers – Kansas City Chapter

Representative F. Alan Wiley, Black and Veatch, Overland Park, Kansas
Alternate Thomas Heausler, Heausler Structural Engineers, Kansas City, Missouri

American Society of Heating, Refrigeration, and Air-Conditioning Engineers

Representative William Staehlin, Office of State Health Planning and Development, Sacramento, California
Alternate Bruce D. Hunn, American Society of Heating, Refrigeration, and Air-Conditioning Engineers

American Society of Mechanical Engineers

Representative Ronald W. Haupt, Pressure Piping Engineering Associates, Inc., Foster City, California
Alternate Timothy M. Adams, Stevenson & Associates, Cleveland, Ohio

American Welding Society

Representative John Gayler, American Welding Society, Miami, Florida
Alternate William R. Oates, American Welding Society, Miami, Florida

APA - The Engineered Wood Association

Representative Thomas D. Skaggs, APA - The Engineered Wood Association, Tacoma, Washington
Alternate Zeno A. Martin, APA - The Engineered Wood Association, Tacoma, Washington

Applied Technology Council

Representative Christopher Rojahn, Applied Technology Council, Redwood City, California
Alternate Edwin T. Dean, Nishkian Dean, Portland, Oregon

Associated General Contractors of America

Representative Jim Rinner, Kitchell CEM, Sacramento, California
Alternate Dirk Haire, Haire Logan, LLP, Annapolis, Maryland

Association of Engineering Geologists

Representative Ellis Krinitzsky, U.S. Army Corps of Engineers, Vicksburg, Mississippi

Alternate Patrick J. Barosh, Patrick J. Barosh and Associates, Bristol, Rhode Island

Association of Major City Building Officials

Representative Andrew A. Adelman, City of Los Angeles, California

Alternate Steve Ikkanda, City of Los Angeles, California

Brick Industry Association

Representative J. Gregg Borchelt, Brick Industry Association, Reston, Virginia

Alternate Wassem Khan, Brick Industry Association, Reston, Virginia

Building Owners and Managers Association International

Representative Ron Burton, Building Owners and Managers Association International, Washington, D.C.

California Geotechnical Engineers Association

Representative Alan Kropp, Alan Kropp and Associates, Berkeley, California

Alternate Matt Rogers, Zeiser Kling Consultants, Inc., Santa Ana, California

California Seismic Safety Commission

Representative Fred Turner, Seismic Safety Commission, Sacramento, California

Canadian National Committee on Earthquake Engineering

Representative R.H. Devall, Canadian National Committee on Earthquake Engineering, Vancouver, British Columbia, Canada

Alternate Cathleen Taraschuk, National Research Council of Canada, Ottawa, Ontario, Canada

Concrete Masonry Association of California and Nevada

Representative Paul D. Bambauer, Concrete Masonry Association of California and Nevada, Citrus Heights, California

Alternate None on Record

Concrete Reinforcing Steel Institute

Representative David P. Gustafson, Concrete Reinforcing Steel Institute, Schaumburg, Illinois
Alternate Scott R. Humphries, Concrete Reinforcing Steel Institute, Schaumburg, Illinois

California Division of the State Architect

Representative Dennis Bellet, Division of State Architect, Sacramento, California
Alternate Howard “Chip” Smith, Jr., Division of State Architect, Sacramento, California

Earthquake Engineering Research Institute

Representative David Bonneville, Degenkolb Engineers, San Francisco, California
Alternate F. Robert Preece, Consultant, San Francisco, California

General Services Administration (9PCT)

Representative Bela I. Palfalvi, General Services Administration 9PCT, San Francisco, California
Alternate Catherine K. Lee, General Services Administration 9 PCT, San Francisco, California

Hawaii State Earthquake Advisory Board

Representative Gary Y. K. Chock, Martin and Chock, Inc., Honolulu, Hawaii
Alternate Paul Okubo, Hawaii State Earthquake Advisory Board, Honolulu, Hawaii

Institute for Business and Home Safety

Representative Jeffrey Sciaudone, Institute for Business and Home Safety, Tampa Florida
Alternate None on Record

Interagency Committee on Seismic Safety in Construction

Representative H. S. Lew, National Institute of Standards and Technology, Gaithersburg, Maryland
Alternate Shyam Sunder, National Institute of Standards and Technology, Gaithersburg, Maryland

International Code Council

Representative Tom Frost, International Code Council, Country Club Hills, Illinois
Alternate None on Record

International Masonry Institute

Representative Diane Throop, Consultant, Cincinnati, Ohio

Alternate Richard Filloramo, International Masonry Institute, Glastonbury, Connecticut

Masonry Institute of America

Representative John Chrysler, Masonry Institute of America, Torrance, California

Metal Building Manufacturers Association

Representative W. Lee Shoemaker, Metal Building Manufacturers Association, Cleveland, Ohio

Alternate Joe N. Nunnery, VP Buildings, Memphis, Tennessee

Mid-America Earthquake Center

Representative Daniel P. Abrams, Mid-America Earthquake Center, University of Illinois, Urbana

Alternate Amr Elnashai, Mid-America Earthquake Center, University of Illinois, Urbana

National Association of Home Builders

Representative Joseph Knarich, National Association of Home Builders, Washington, D.C.

Alternate None on Record

National Concrete Masonry Association

Representative Jason J. Thompson, National Concrete Masonry Association, Herndon, Virginia

Alternate Jeff Greenwald, National Concrete Masonry Association, Herndon, Virginia

National Conference of States on Building Codes and Standards

Representative Richard T. Conrad, Division of State Architect, Sacramento, California

Alternate Robert C. Wible, National Conference of States on Building Codes and Standards, Herndon, Virginia

National Council of Structural Engineers Associations

Representative Howard Simpson, Simpson, Gumpertz and Heger, Arlington, Massachusetts

Alternate W. Gene Corley, Construction Technology Laboratories, Skokie, Illinois

National Elevator Industry, Inc.

Representative George A. Kappenhagen, Schindler Elevator Corporation, Morristown, New Jersey
Alternate Jean Smith, Schindler Elevator Corporation, Morristown, New Jersey

National Fire Sprinkler Association

Representative Russell P. Fleming, National Fire Sprinkler Association, Patterson, New York
Alternate Victoria Valentine, National Fire Sprinkler Association, Patterson, New York

National Institute of Building Sciences

Representative Henry L. Green, State of Michigan Department of Consumer and Industry Services, Okemos, Michigan
Alternate Gerald H. Jones, Consultant, Kansas City, Missouri

National Ready Mixed Concrete Association

Representative George Muste, National Ready Mixed Concrete Association, Silver Spring, Maryland
Alternate Colin L. Lobo, National Ready Mixed Concrete Association, Silver Spring, Maryland

Portland Cement Association

Representative Joseph J. Messersmith, Jr., Portland Cement Association, Rockville, Virginia
Alternate S. K. Ghosh, S. K. Ghosh Associates, Inc., Palatine, Illinois

Precast/Prestressed Concrete Institute

Representative Jason J. Krohn, Precast/Prestressed Concrete Institute, Chicago, Illinois
Alternate David A. Sheppard, Consulting Structural Engineer, Sonora, California

Rack Manufacturers Institute

Representative Victor Azzi, Rack Manufacturers Institute, Rye, New Hampshire
Alternate John Nofsinger, Rack Manufacturers Institute, Charlotte, North Carolina

Santa Clara University

Representative Reynaud Serrette, Santa Clara University, Santa Clara, California

Alternate Wendy Taniwangsa, Santa Clara University, Santa Clara, California

Steel Deck Institute, Inc.

Representative Steven A. Roehrig, Steel Deck Institute, Algonquin, Illinois

Alternate Walter Schultz, Nucor Research & Development, Norfolk, Nebraska

Structural Engineers Association of California

Representative James O. Malley, Degenkolb Engineers, San Francisco, California

Alternate Allan Porush, Dames & Moore, Los Angeles, California

Structural Engineers Association of Central California

Representative Dennis Bellet, Structural Engineers Association of California, Fair Oaks, California

Alternate Tom H. Hale, Office of Statewide Health Planning and Development, Sacramento, California

Structural Engineers Association of Colorado

Representative James R. Harris, J. R. Harris and Company, Denver, Colorado

Alternate Dave Houdeshell, JVA, Incorporated, Boulder, Colorado

Structural Engineers Association of Illinois

Representative W. Gene Corley, Construction Technology Laboratories, Skokie, Illinois

Alternate None on Record

Structural Engineers Association of Kentucky

Representative Mark A. Caldwell, Apex Engineering, Calvert City, Kentucky

Alternate Jiin Long Huang, Consultant, Lexington, Kentucky

Structural Engineers Association of Northern California

Representative Simin Naseeh, Structural Engineers Association of Northern California, San Francisco, California

Alternate Edwin G. Zacher, H. J. Brunnier Associates, San Francisco, California

Structural Engineers Association of Oregon

Representative Michael R. Hagerty, Consulting Engineer, Portland, Oregon

Alternate Joseph C. Gehlen, Kramer Gehlen Associates, inc., Vancouver, Washington

Structural Engineers Association of San Diego

Representative Chris Kamp, Stedman Dyson Structural Engineers, San Diego, California

Alternate None on Record

Structural Engineers Association of Southern California

Representative Richard L. Hess, Hess Engineering, Los Alamitos, California

Alternate Robert T. Lyons, Brandow & Johnston Associates, Los Angeles, California

Structural Engineers Association of Texas

Representative Joseph Kallaby, OSI, Houston, Texas

Alternate Michael D. Engelhardt, University of Texas, Austin

Structural Engineers Association of Utah

Representative A. Parry Brown, Reaveley Engineers and Associates, Salt Lake City, Utah

Alternate David L. Pierson, ARW Engineers, Ogden, Utah

Structural Engineers Association of Washington

Representative Doug Wilson, Reid Middleton, Inc., Everett, Washington

Alternate Michael Valley, Magnusson Klemencic, Seattle, Washington

The Masonry Society

Representative Arturo E. Schultz, University of Minnesota, Minneapolis

U.S. Army Construction & Engineering Research Laboratory

Representative John R. Hayes, US Army CERL, Champaign, Illinois

Alternate Steven C. Sweeney, US Army CERL, Champaign, Illinois

Western States Clay Products Association

Representative Jeff I. Elder, Western State Clay Products Association, West Jordan, Utah

Alternate None on Record

Western States Structural Engineers Association

Representative Greg Shea, Moffat, Nichol and Bonney, Inc., Portland, Oregon

Alternate William T. Rafferty, Structural Design North, Spokane, Washington

Wire Reinforcement Institute, Inc.

Representative Roy H. Reiterman, Roy H. Reiterman, PE & Associates, Troy, Michigan

Alternate Robert C. Richardson, Consultant, Sun Lakes, Arizona

**REPRESENTATIVES OF BSSC AFFILIATE MEMBERS
AND THEIR ALTERNATES**

Bay Area Structural, Inc.

Representative David Benaroya Helfant, Bay Area Structural, Inc., Oakland, California
Alternate None on Record

Building Technology, Incorporated

Representative David B. Hattis, Building Technology, Inc., Silver Spring, Maryland
Alternate None on Record

City of Hayward

Representative Paul O. Johnson, City of Hayward, California
Alternate None on Record

Felten Engineering Group

Representative Greg Felten, Felten Engineering Group, Phoenix, Arizona
Alternate Ken Mulder, Felten Engineering Group, Phoenix, Arizona

H & H Group, Inc.

Representative Les. L. Hegyi, H&H Group, Inc., McLean, Virginia
Alternate None on Record

HLM Design

Representative Philip J. Antis, Burns Engineering, McLean, Virginia
Alternate Shawn M. Elliott, HLM Design, Bethesda, Maryland

LaPay Consulting, Inc.

Representative William S. LaPay, LaPay Consulting, Inc., Export, Pennsylvania
Alternate None on Record

Square D Company

Representative Philip J. Caldwell, Square D Company, Seneca, South Carolina
Alternate Jeffrey Gatscher, Square D Company, Nashville, Tennessee

Steel Joist Institute

Representative Robert R. Hackworth, Steel Joist Institute, Myrtle Beach, South Carolina

Alternate None on Record

Vibration Mountings and Controls

Representative John P. Giuliano, Vibration Mountings and Controls, Bloomingdale, New Jersey

Alternate Rajendra Prasad, Vibration Mountings and Controls, Bloomingdale, New Jersey

This page is intentionally left blank.