

# (PRE-FINAL) TRAVIS AIR FORCE BASE INSTALLATION FACILITIES STANDARDS (IFS)



Installation Elements



Site Development



Facilities Exteriors



Facilities Interiors

**APPROVED FOR PUBLIC RELEASE; DISTRIBUTION UNLIMITED**

Signature Field

**Travis Air Force Base IFS**

**Table of Contents**

|  |    |   |    |
|--|----|---|----|
| <b>A. OVERVIEW</b> .....                           | 5  | B03.2.3. Preserves                          |    |
| A01. Facility Hierarchy .....                      | 6  | B03.2.4. Perimeter Fence                    |    |
| A02. Facility Quality .....                        | 6  | <b>C. SITE DEVELOPMENT</b> .....            | 30 |
| A03. Facility Districts .....                      | 6  | C01. Site Design .....                      | 30 |
| <b>B. INSTALLATION ELEMENTS</b> .....              | 8  | C01.1. Site Design Considerations .....     | 30 |
| B01. Comprehensive Planning .....                  | 8  | C01.2. Building Orientation .....           | 32 |
| B01.1. Installation Development Plan (IDP) .....   | 8  | C02. Utilities .....                        | 32 |
| B01.1.1. IFS Component Plan of IDP                 |    | C02.1. Utility Components .....             | 33 |
| B01.1.2. Brief History of Base                     |    | C03. Parking Areas .....                    | 33 |
| B01.1.3. Future Development                        |    | C03.1. Configurations and Design .....      | 34 |
| B02. Street Envelope Standards .....               | 11 | C03.1.1. Paving and Striping                |    |
| B02.1. Hierarchy of Streets .....                  | 11 | C03.1.2. Curbing                            |    |
| B02.1.1. Arterial Streets                          |    | C03.1.3. Internal Islands and Medians       |    |
| B02.1.2. Collector Streets                         |    | C03.2. Parking Structures .....             | 38 |
| B02.1.3. Local Streets                             |    | C03.3. Connectivity .....                   | 38 |
| B02.1.4. Special Routes                            |    | C04. Stormwater Management .....            | 39 |
| B02.2. Hierarchy of Intersections .....            | 16 | C04.1. Stormwater Requirements .....        | 39 |
| B02.2.1. Arterials                                 |    | C05. Sidewalks, Bikeways and Trails .....   | 39 |
| B02.2.2. Arterial/Collector                        |    | C05.1. Circulation and Paving .....         | 40 |
| B02.2.3. Collectors                                |    | C05.1.1. Ramps and Stairs                   |    |
| B02.2.4. Special Intersections                     |    | C05.1.2. Lighting                           |    |
| B02.2.5. Street Frontage Requirements              |    | C06. Landscape .....                        | 43 |
| B02.2.6. Sight Lines                               |    | C06.1. Climate-based Materials .....        | 43 |
| B02.3. Street Elements .....                       | 19 | C06.1.1. Landscape Design Concept           |    |
| B02.3.1. Paving                                    |    | C06.1.2. Xeriscape Design Principles        |    |
| B02.3.2. Curb and Gutter                           |    | C06.1.3. Minimizing Water Requirements      |    |
| B02.3.3. Utility Service Elements                  |    | C06.1.4. Plant Material Selection           |    |
| B02.3.4. Traffic Signs                             |    | C06.1.5. Water Budgeting (Hydrozones)       |    |
| B02.3.5. Street Lighting                           |    | C06.1.6. Base Entrance Landscaping          |    |
| B02.3.6. Other                                     |    | C06.1.7. Streetscape Landscaping            |    |
| B03. Open Space / Public Space .....               | 22 | C06.1.8. Pedestrian Circulation Landscaping |    |
| B03.1. Plazas, Monuments and Static Displays ..... | 23 | C06.1.9. Parking Lot Landscaping            |    |
| B03.1.1. Paved Plazas                              |    | C06.1.10. Screen/Accent Landscaping         |    |
| B03.1.2. Sculptures, Markers and Statuary          |    | C06.1.11. Other                             |    |
| B03.1.3. Static Display of Aircraft                |    | C07. Site Furnishings .....                 | 52 |
| B03.2. Grounds and Perimeters .....                | 26 | C07.1. Furnishings and Elements .....       | 53 |
| B03.2.1. Parade Grounds                            |    |   |    |
| B03.2.2. Parks                                     |    |   |    |



Table of contents continued

|  |           |  |     |
|--|-----------|--|-----|
| C07.2. Site Furnishings Products, Materials / Color .. | 55        | D03.3.4. Thermal Shading                           |     |
| C07.2.1. Barbeque Grills                               |           | D03.3.5. Renewable Heating/Cooling                 |     |
| C07.2.2. Benches                                       |           | D03.3.6. Solar Photovoltaic System                 |     |
| C07.2.3. Bike Racks                                    |           | D03.3.7. Solar Thermal System                      |     |
| C07.2.4. Bike Lockers                                  |           | D04. Building Entrances .....                      | 92  |
| C07.2.5. Bollards                                      |           | D04.1. Primary Entrances .....                     | 93  |
| C07.2.6. Bus Shelters                                  |           | D04.2. Secondary Entrances .....                   | 93  |
| C07.2.7. Drinking Fountains                            |           | D05. Wall Systems .....                            | 94  |
| C07.2.8. Dumpster Enclosures / Gates                   |           | D05.1. Hierarchy of Materials .....                | 95  |
| C07.2.9. Fencing                                       |           | D05.2. Layout, Organization and Durability .....   | 95  |
| C07.2.10. Flagpoles                                    |           | D05.3. Equipment, Vents and Devices .....          | 96  |
| C07.2.11. Lighting – Landscape / Accent                |           | D05.4 Wall Systems Materials .....                 | 96  |
| C07.2.12. Litter and Ash Receptacles                   |           | D05.4.1. Flat Metal Panels                         |     |
| C07.2.13. Picnic Tables                                |           | D05.4.2. Brick Veneer                              |     |
| C07.2.14. Planters – Free Standing                     |           | D05.4.3. Architectural Precast                     |     |
| C07.2.15. Play Equipment                               |           | D05.4.4. Stucco Over Sheathing                     |     |
| C07.2.16. Screen Walls                                 |           | D05.4.5. Curtain Wall                              |     |
| C07.2.17. Tree Grates                                  |           | D05.4.6. Cast-in Place Concrete                    |     |
| C07.2.18. Other  |           | D05.4.7. Tilt-up Concrete                          |     |
| C08. Exterior Signs .....                              | 70        | D05.4.8. Ribbed Metal Sheeting                     |     |
| C08.1. Colors and Types .....                          | 71        | D05.4.9. EFIS                                      |     |
| C08.1.1. Materials and Color Specifications            |           | D05.4.10. GRFC                                     |     |
| C08.1.2. Installation and Gate Identification Signs    |           | D05.4.11. Concrete Block                           |     |
| C08.1.3. Building Identification Signs                 |           | D05.4.12. Fiber Cement Siding                      |     |
| C08.1.4. Traffic Control Devices (Street Signs)        |           | D05.4.13. Other                                    |     |
| C08.1.5. Directional and Wayfinding Signs              |           | D06. Doors and Windows .....                       | 100 |
| C08.1.6. Informational Signs                           |           | D06.1. Types .....                                 | 101 |
| C08.1.7. Motivational Signs                            |           | D06.2. Layout and Geometry .....                   | 101 |
| C08.1.8. Parking Lot Signs                             |           | D06.3. Glazing and Shading .....                   | 101 |
| C08.1.9. Regulatory Signs                              |           | D06.4. Hardware .....                              | 101 |
| C08.1.10. Other  |           | D06.5. Doors and Windows Materials .....           | 102 |
| C09. Lighting .....                                    | 79        | D06.5.1. Anodized Aluminum                         |     |
| C09.1. Fixtures and Lamping .....                      | 79        | D06.5.2. Hollow Metal                              |     |
| C09.2. Light Fixture Types .....                       | 80        | D06.5.3. Aluminum-clad Wood                        |     |
| C09.2.1. Street Lighting                               |           | D06.5.4. Other                                     |     |
| C09.2.2. Parking Lot Lighting                          |           | D07. Roof Systems .....                            | 106 |
| C09.2.3. Lighted Bollards                              |           | D07.1. Roof Type and Form .....                    | 107 |
| C09.2.4. Sidewalk Lighting                             |           | D07.2. Roof Slope .....                            | 107 |
| C09.2.5. Walls / Stairs Lighting                       |           | D07.3. Parapets and Copings .....                  | 108 |
| C09.2.6. Other   |           | D07.4. Color and Reflectivity .....                | 108 |
| <b>D. FACILITIES EXTERIORS .....</b>                   | <b>85</b> | D07.5. Gutters, Downspouts, Scuppers, Drains ..... | 108 |
| D01. Supporting the Mission .....                      | 85        | D07.6. Roof Vents and Elements .....               | 109 |
| D02. Sustainability .....                              | 85        | D07.7. Clerestories and Skylights .....            | 109 |
| D03. Architectural Features .....                      | 86        | D07.8. Vegetated Roof .....                        | 110 |
| D03.1. Orientation, Massing and Scale .....            | 87        |  |     |
| D03.2. Architectural Character .....                   | 87        |  |     |
| D03.3. Details and Color .....                         | 87        |  |     |
| D03.3.1. Climate-based Data                            |           |  |     |
| D03.3.2. Natural Ventilation System                    |           |  |     |
| D03.3.3. Thermal Mass                                  |           |  |     |

Table of contents continued

|  |            |  |            |
|--|------------|--|------------|
| D07.9. Roof Systems Materials .....            | 110        | E04. Ceilings .....                                | 132        |
| D07.9.1. Standing Seam Metal                   |            | E04.1. Ceiling Materials .....                     | 132        |
| D07.9.2. Membrane Single-ply                   |            | E04.1.1. Exposed Framing (Roof / Floor Structure   |            |
| D07.9.3. Built-up Multi-ply                    |            | Above)   |            |
| D07.9.4. Concrete Tile                         |            | E04.1.2. Exposed Concrete                          |            |
| D07.9.5. Clay Tile                             |            | E04.1.3. Grid and Acoustical Tile                  |            |
| D07.9.6. Slate Shingles                        |            | E04.1.4. Gypsum Board                              |            |
| D07.9.7. Vegetated System                      |            | E04.1.5. Metal Panels                              |            |
| D07.9.8. Ribbed Metal Sheeting                 |            | E04.1.6. Wood                                      |            |
| D07.9.9. Composite Shingles                    |            | E04.1.7. Rapidly-Renewable Products                |            |
| D07.9.10. Other                                |            | E04.1.8. Other                                     |            |
| D08. Structural Systems .....                  | 114        | E05. Doors and Windows .....                       | 135        |
| D08.1. Systems and Layouts .....               | 115        | E05.1. Doors and Windows and Frames Materials .... | 135        |
| D08.2. Structural Systems Materials .....      | 115        | E05.1.1. Aluminum                                  |            |
| D08.2.1. Concrete                              |            | E05.1.2. Hollow Metal                              |            |
| D08.2.2. Insulated Concrete Forming (ICF)      |            | E05.1.3. Wood                                      |            |
| D08.2.3. Steel                                 |            | E05.1.4. Other                                     |            |
| D08.2.4. Pre-Engineered Steel                  |            | E06. Casework Systems .....                        | 139        |
| D08.2.5. Masonry                               |            | E06.1. Casework Materials .....                    | 139        |
| D08.2.6. Heavy Timber                          |            | E06.1.1. Plastic Laminate                          |            |
| D08.2.7. Light-gauge Steel                     |            | E06.1.2. Solid Polymer Surface                     |            |
| D08.2.8. Lumber Framing                        |            | E06.1.3. Rapidly-Renewable Products                |            |
| D08.2.9. Other                                 |            | E06.1.4. Metal                                     |            |
| D09. Mechanical, Electrical and Plumbing ..... | 118        | E06.1.5 Other                                      |            |
| D09.1. Passive and Active Systems .....        | 119        | E06.2. Countertop Materials .....                  | 142        |
| D09.2. Functionality and Efficiency .....      | 119        | E06.2.1. Plastic Laminate                          |            |
| <b>E. FACILITIES INTERIORS .....</b>           | <b>120</b> | E06.2.2. Solid Polymer Surface                     |            |
| E01. Building Configurations .....             | 121        | E06.2.3. Natural Stone                             |            |
| E01.1. Layout and Common Areas .....           | 121        | E06.2.4. Cast Stone                                |            |
| E01.1.1. Interior Design Process               |            | E06.2.5. Metal                                     |            |
| E01.1.2. Codes and Regulations                 |            | E06.2.6 Other                                      |            |
| E01.2. Quality and Comfort .....               | 122        | E07. Furnishings .....                             | 144        |
| E02. Floors .....                              | 123        | E07.1. Durability and Serviceability .....         | 144        |
| E02.1. Floor Materials .....                   | 123        | E07.2. Accessories .....                           | 144        |
| E02.1.1. Prepared Slabs                        |            | E08. Interior Signs .....                          | 144        |
| E02.1.2. Natural Stone and Terrazzo            |            | E08.1 Types and Color .....                        | 144        |
| E02.1.3. Quarry Tile                           |            | E08.2. Interior Signs Materials .....              | 145        |
| E02.1.4. Ceramic Tile                          |            | E09. Lighting, Power and Communication .....       | 145        |
| E02.1.5. Resilient Floor                       |            | E09.1. Functionality and Efficiency .....          | 145        |
| E02.1.6. Carpet                                |            | E09.2. Types and Color .....                       | 145        |
| E02.1.7. Rapidly-Renewable Products            |            | <b>F. Appendices .....</b>                         | <b>146</b> |
| E02.1.8. Other                                 |            | <b>G. Appendices .....</b>                         | <b>146</b> |
| E03. Walls .....                               | 128        |  |            |
| E03.1. Wall Materials .....                    | 128        |  |            |
| E03.1.1. Concrete                              |            |  |            |
| E03.1.2. Masonry                               |            |  |            |
| E03.1.3. Ceramic Tile                          |            |  |            |
| E03.1.4. Gypsum Board                          |            |  |            |
| E03.1.5. Metal Panels                          |            |  |            |
| E03.1.6. Wood Paneling                         |            |  |            |
| E03.1.7. Rapidly-Renewable Products            |            |  |            |
| E03.1.8. Other                                 |            |  |            |

## A. OVERVIEW

Comply with Air Force Corporate Standards for Overview:

<http://afcfs.wbdg.org/index.html>

This Installation Facilities Standards (IFS) document is part of the Air Force Corporate Facilities Standards (AFCFS) program to assist bases in implementing and maintaining facilities standards as appropriate for efficient operations within the respective climate region. IFS fully replaces, consolidates and simplifies existing facilities standards documents, such as the Architectural Compatibility Plan (ACP) or ACGs, FEPs, etc., and organizes information using the same structure, or Table of Contents, as the AFCFS website.

IFS reflects the AFCFS' concepts of "Facility Hierarchy" (categorizing facilities into group numbers) and "Facility Quality" (assigning an appropriate level of quality to each group number) and applies these principles at the base level. Applicable DoD and Air Force criteria such as UFCs, AFIs, Memoranda, and UFGSs (Guide Specs) are referenced and linked within IFS to ensure the document is always current.

Navigating within this IFS is efficient and straightforward. Please use the interactive Table of Contents to locate subject matter, and click on the title of a section to access it. From any page, click on the "Back to Table of Contents" footer to return. Content is organized into 4 major sections: Installation Elements, Site Development, Facilities Exteriors and Facilities Interiors.

This IFS document begins as a fill-in PDF form, which is fully editable, and becomes a "living document" that can be regularly updated by base-level personnel following a format that is consistent across the Air Force. While the format is standardized, IFS content is customized for base operations and the local climate to ensure mission success while emphasizing reduced maintenance and reduced initial costs, life-cycle costs, energy use, and water use.

1. Conformance to Air Force Corporate Facilities Standards (AFCFS) and Installation Facilities Standards (IFS) are required by Air Force Instruction (AFI) 32-1023 and Air Force Memorandum. Please refer to the AFCFS website for links to documentation on current policy.
2. Requests to deviate from any installation facilities standards, that are Unified Facilities Criteria (UFC) requirements, will follow the process outlined in the AFCFS for UFC waivers and exemptions.
3. The IFS is a component plan of the Installation Development Plan (IDP) per Air Force Instruction (AFI) 32-7062 (replacing the Architectural Compatibility Plan). All military construction projects and Non-Appropriated Funds (NAF) facilities are required to comply with the IDP and its IFS component plan by AFI 32-1023. The Base Civil Engineer (BCE) maintains and implements the IDP and its component plans, to include the IFS.
4. Please refer to the AFCFS website as a portal to reference materials and requirements documents for design and construction projects (via links). Specific references to current DoD memoranda and Air Force criteria are updated periodically to provide the most current guidance and requirements. Programming, design and contract documents should list "current edition" for all reference and requirements documents. The documents in force at the date of execution of the design and/or construction contract shall be the governing version.
5. *Advanced Modeling Requirements:*  
*For all Air Force projects requiring advanced modeling, to include 3D visualization, Building Information Modeling (BIM), facility data, quantity take-off, geospatial, etc., follow the Army standards. Refer to USACE Minimum Model Matrix (M3) and Project Execution Plan (PxP) which outline required model uses. Refer to [CAD BIM Technology Center \(Contract Requirements\)](#) for more information on M3 and PxP.*
6. Joint Bases shall implement IFS under their Joint-Base designation with volume numbers for individual installations following the IFS Development Tool template. For example, for Joint Base Langley-Eustis, provide: Vol. 1 Langley AFB and Vol. 2 Fort Eustis.

Applicable  N/A Select number of graphics / images (large: 800 px x 440 px) to insert 1

Image Tool 800 x 440

Applicable  N/A Select number of graphics / images (small: 250 px x 188 px) to insert 3

Image Tool 250 x 188



Flightline and Airfield Setting



Mountain Backdrop



Coastal Flora



Regional Vernacular Architecture

### A.01. FACILITY HIERARCHY

Comply with AF Corporate Standards for Facility Hierarchy (and subsections):

<http://afcs.wbdg.org/facility-hierarchy/index.html>

### A.02. FACILITY QUALITY

Comply with AF Corporate Standards for Facility Quality (and subsections):

<http://afcs.wbdg.org/facility-quality/index.html>

### A.03. FACILITY DISTRICTS

Comply with AF Corporate Standards for Facility Districts (and subsections):

<http://afcs.wbdg.org/facility-districts/index.html>



Image Tool 800 x 800

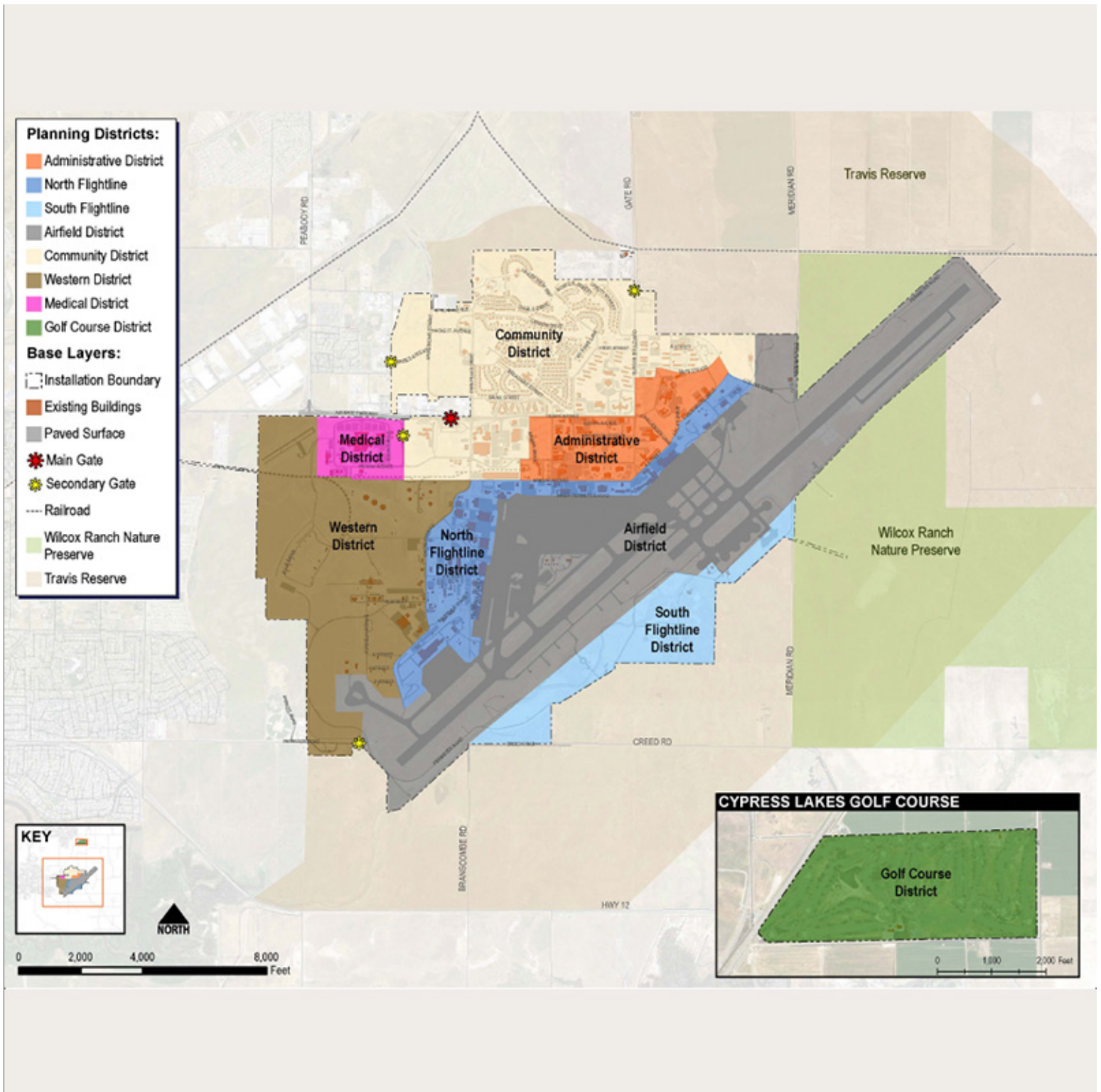

**Note:** Apply the base-wide standards in this IFS for Installation Elements, Site Development, Facilities Exteriors and Facilities Interiors (products, materials, color, etc.). Following application of the base-wide standards, refer to the Appendix and apply any additional requirements specifically related to the Facility District.

## B. INSTALLATION ELEMENTS

Comply with Air Force Corporate Standards for Installation Elements:  
<http://afcs.wbdg.org/installation-elements/index.html>

### B.01. COMPREHENSIVE PLANNING

Comply with Air Force Corporate Standards for Comprehensive Planning:  
<http://afcs.wbdg.org/installation-elements/comprehensive-planning/index.html>

#### B01.1. Installation Development Plan (IDP)

Applicable  N/A Select number of graphics / images (large: 800 px x 440 px) to insert 1

Image Tool 800 x 440

Applicable  N/A Small graphics do not apply

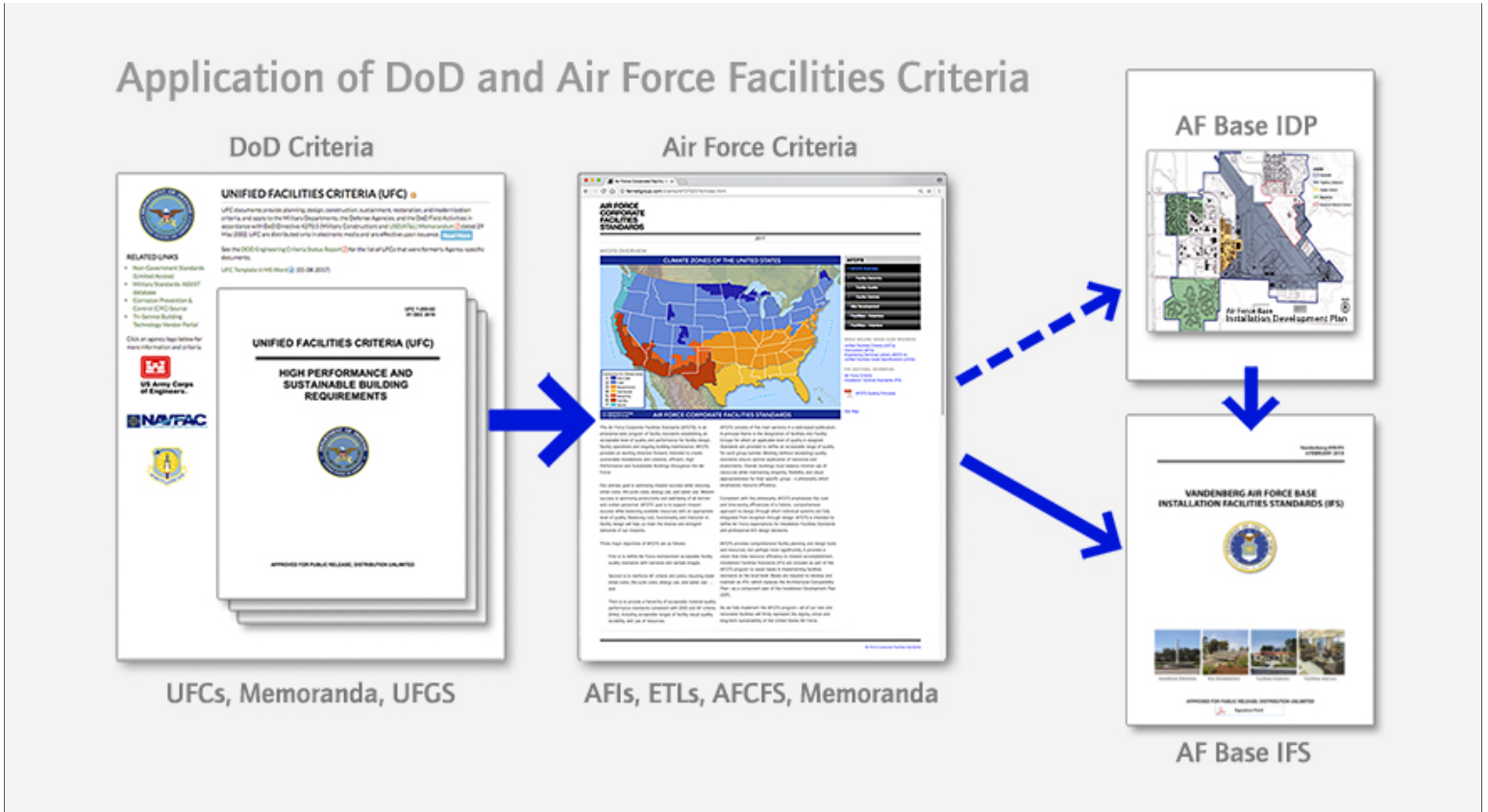

Department of Defense, Department of the Air Force and Air Force Base Criteria

1. The Base Civil Engineer is responsible for developing, maintaining and implementing the installation's Comprehensive Planning documents and to ensure that the Installation Development Plan (IDP) is prepared, maintained, and implemented following AFI 32-7062.1. The base is required to provide and maintain Installation Facilities Standards (IFS) as a Component Plan of the base's Installation Development Plan (IDP).

#### B01.1.1. IFS Component Plan of IDP

Applicable  N/A Large graphics do not apply

Applicable  N/A Small graphics do not apply

1. Maintain this Installation Facilities Standards (IFS) as a Component Plan of the base's Installation Development Plan (IDP).



## B01.1.2. Brief History of Base

Applicable  N/A Large graphics do not apply

Applicable  N/A Select number of graphics / images (small: 250 px x 188 px) to insert 3

Image Tool 250 x 188



Fairfield-Suisun Army Air Base 1942



First Base HQ at Fairfield-Suisun AAB ca. 1943



Douglas C-54 "Skymaster" Fairfield ca. 1948

The establishment of an Army airfield near Fairfield and Suisun City was first recommended in December 1941, shortly after the Japanese attack on Pearl Harbor. Representatives from Fourth Air Force and the Army Corps of Engineers investigated the area and approved the idea in early 1942.

On April 22, 1942, the Office of the Chief of Engineers, Washington DC, authorized spending \$998,000 for construction of two runways and a few temporary buildings on 945 acres. The project received a top wartime priority, and construction began in the summer of 1942. On May 17, 1943, the Air Transport Command officially activated Fairfield-Suisun Army Air Base, named after the two cities that the base was located between.

Travis Air Force Base is named in honor of Brigadier General Robert F. Travis, who was killed when his B-29-MR crashed on the installation on August 5, 1950. At the time of his death, General Travis was the commander of the 5th Strategic Reconnaissance Wing and 9th Bombardment Wing.

General Travis' popularity and the shock of his death led base officials and the local community to sponsor renaming the base in his honor. The proposal was favored in Washington DC, and on October 20, 1950 the base was re-named Travis Air Force Base. Although Travis is now the home of the largest airlift organization in the Air Force, it began as an isolated airstrip with a few tar paper shacks set in the middle of a wind-swept prairie during World War II. The field was named Fairfield-Suisun Army Air Base, after the two closest, mostly agricultural towns. The base was first planned shortly after the December 7, 1941 attack on Pearl Harbor as a home for medium bombers and fighters assigned to defend the West Coast. The first runway and temporary buildings were constructed by the Army Corps of Engineers in the summer of 1942. They were used initially by Army and Navy fighter planes for takeoff and landing practice. For a few months, the outline of an aircraft carrier's deck was painted on the runway to help newly-commissioned Navy pilots practice landings. The strong local prevailing winds nearly duplicated those at sea.

Shortly after construction began, however, the base's potential as a major aerial port and supply transfer point for the Pacific theater led the Army Air Corps to assign it to the newly-designated Air Transport Command. The base officially opened on June 1, 1943, with a primary mission of preparing various military aircraft, mainly bombers and transports, for the Pacific war zone and ferrying them to that region. Consairway, a division of the Consolidated Vultee Aircraft Corporation, airlifted some of the cargo and personnel to the Pacific using their fleet of 13 converted LB-30/B-24 "Liberator" bombers. The first host unit for the base was the 23rd Ferrying Group. At the end of WWII, the primary mission became the airlift of troops and supplies to occupied Japan and Korea, and the processing of war-weary returning GIs. On June 1, 1948, the Military Air Transport Service (MATs) assumed jurisdiction. In July, two of the base's air transport C-54 squadrons left for Europe to assist in the Berlin Airlift.

On May 1, 1949, the Strategic Air Command became the parent major command for the base, turning it into a major long-range reconnaissance and intercontinental bombing installation. For the next nine years, airlift operations became secondary while the base served as home for SAC bombers such as the Boeing B-29 "Superfortress," Convair B-36 "Peacemaker," and the Boeing B-52G "Stratofortress." During this period, new hangars appeared, runways were added and widened, and permanent barracks and family living quarters were built. The base grew to its present size, which encompasses 6,258 acres.

The Military Air Transport Service (MATS) resumed command of Travis on July 1, 1958, after SAC's new dispersal policy led to the transfer of the 14th Air Division to Beale Air Force Base, California. The base became headquarters to the 1501st Air Transport Wing in 1955; for MATS' Western Transport Air Force (later the 22nd Air Force) in 1958; and the 60th Military Airlift Wing in 1966 (later to be re-designated to the present 60th Air Mobility Wing). The 349th Military Airlift Wing (United State Air Force Reserve) moved to Travis from Hamilton Air Force Base, California, in 1969. Travis became part of the Air Mobility Command on June 1, 1992, when airlift assets from Military Airlift Command and Strategic Air Command tankers were fused into a single team. From 1969 to the present, the 60th and 349th Air Mobility Wings have worked closely to make Travis one of the best and most versatile bases in the United States Air Force. The base has provided continuous airlift support in the face of world-wide contingencies since adding air refueling to its mission in September 1994.

### B01.1.3. Future Development

Applicable  N/A Select number of graphics / images (large: 800 px x 440 px) to insert 1

Image Tool 800 x 440

Applicable  N/A Small graphics do not apply



Future Development Graphic from the IDP

1. Follow AFI 32-7062 for Air Force Comprehensive Planning, the Comprehensive Planning Process, Comprehensive Planning Requirements, and Geospatial Mapping.
2. Address all future development under the Installation Development Plan (IDP).



## B02. STREET ENVELOPE STANDARDS

Comply with Air Force Corporate Standards for Installation Elements:

<http://afcs.wbdg.org/installation-elements/index.html>

Comply with AF Corporate Standards for Street Envelope Standards:

<http://afcs.wbdg.org/installation-elements/street-envelope-standards/index.html>

### B02.1. Hierarchy of Streets

Applicable  N/A Select number of graphics / images (large: 800 px x 440 px) to insert 1

Image Tool 800 x 440

Applicable  N/A Select number of graphics / images (small: 250 px x 188 px) to insert 3

Image Tool 250 x 188



Arterial Street, Collector Street and Service Drives

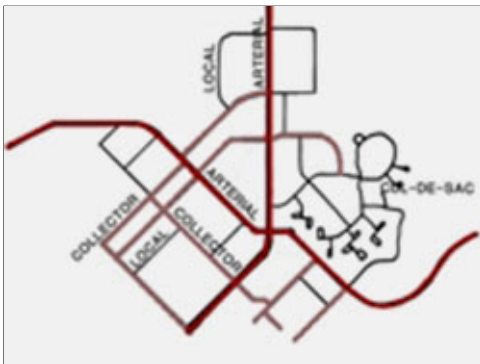

Hierarchy of Streets

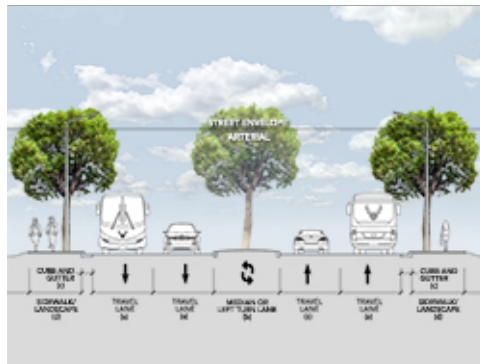

Street Envelope Section



Greenbelt along Travis Avenue

1. Develop and evolve a hierarchical transportation network of arterial, collector and local streets following UFC 3-201-01 and its industry references.

2. Provide consistent functionality throughout the installation and a level of visual quality relating to the adjacent Facility Group number.
3. Routes along facilities in Group 1 may have materials, finishes and features with a higher visual quality than Groups 2, 3 and 4. Reduce maintenance requirements by installing highly durable materials and finishes in routes along Group 3 industrial facilities.
4. Special routes may have a visual quality comparable to those along facilities in Group 1.
5. Create and maintain arterials with two lanes of traffic in each direction with landscaped or paved medians as applicable to the local climate and adjacent facility group designation / land use.
6. Minimize stops and turns along arterials. Eliminate on-street parking along arterials and collector streets.
7. Connect arterials to local streets with appropriately scaled collector streets.
8. Provide appropriate landscape setbacks and pedestrian buffers along all streets.
9. Minimize and consolidate curb cuts along streets.
10. Ensure access for emergency and service vehicles.
11. Define bicycle traffic routes in the Installation Development Plan or its applicable component plans.
12. Provide illustrations in the Installation Facilities Standards (IFS) to include street cross-sections and plans for every type of street specified on the installation. At a minimum provide dimensions for vehicular traffic-lanes, curb radii, medians, bike lanes, pedestrian buffers, sidewalks, crosswalks, tree planting areas, and on-street parking configurations.
13. Define appropriate force protection features, site furnishings, signs, lighting, utilities, and paving in the IFS.
14. Service Drives: Service drives are used to access service areas of facilities in the cantonment area. Service drives shall be combined with parking drives to serve multiple facilities and provide with access control point meeting minimum antiterrorism setback standards and signage that clearly identifies the service drive and restricted access. Service drives shall have a clear width of 20 feet, set back from facilities by 10 feet.
15. Fire Access Lanes: All ground level portions of structures must be within 150 feet of a drivable surface. Fire access lanes shall have a clear width of 20 feet, set back from facilities by 10 feet with a minimum vertical clearance of 13.5 feet and set 15 feet from fire hydrants and standpipe connections.



## B02.1.1. Arterial Streets

Applicable  N/A Select number of graphics / images (large: 800 px x 440 px) to insert 1

Image Tool 800 x 440

Applicable  N/A Select number of graphics / images (small: 250 px x 188 px) to insert 2

Image Tool 250 x 188

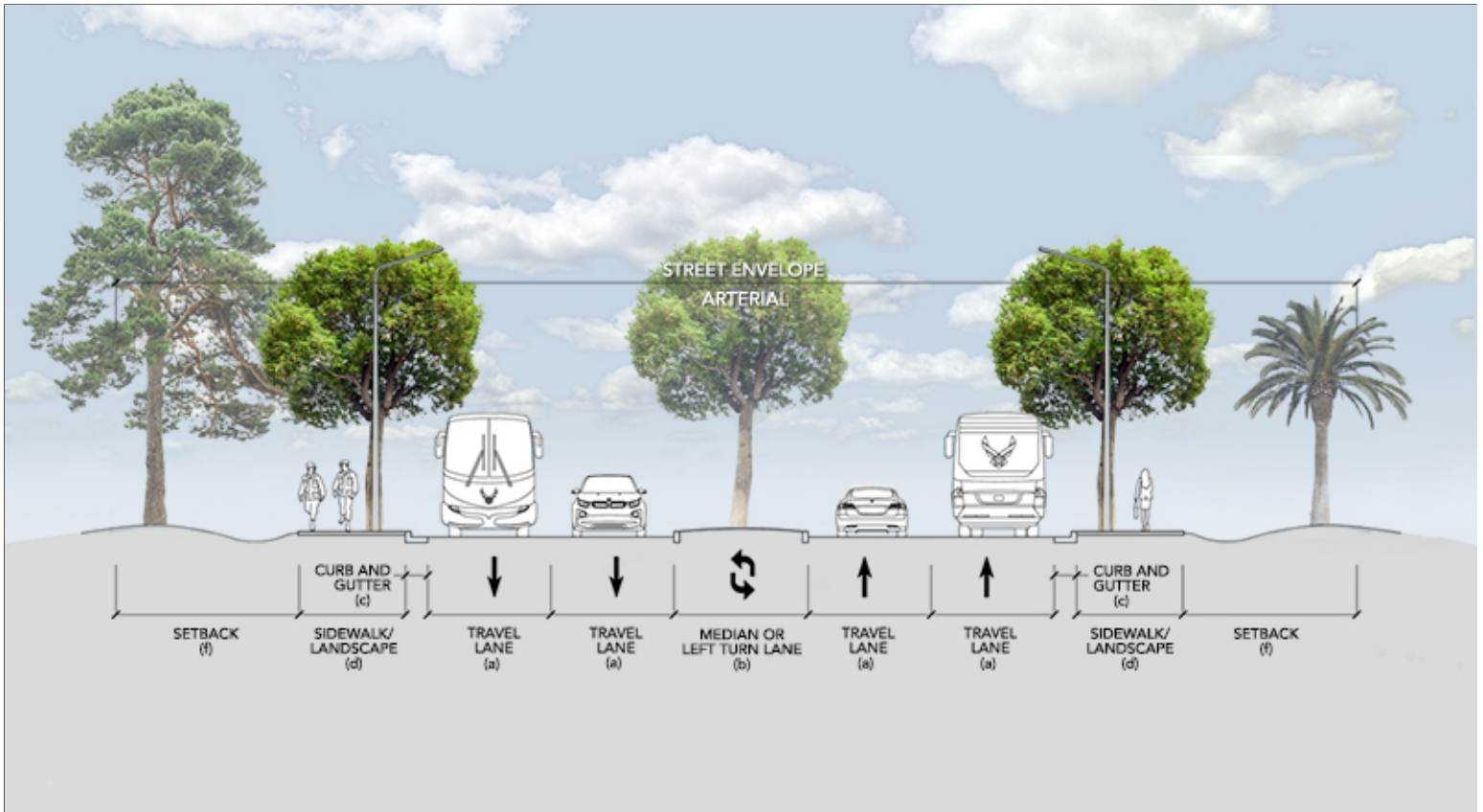

Travel Lane (a): 12' Median (b): 12' Curb and Gutter (c): 2' Sidewalk / Landscape (d): 12' Setback (f): Min. 35' or per ATFP

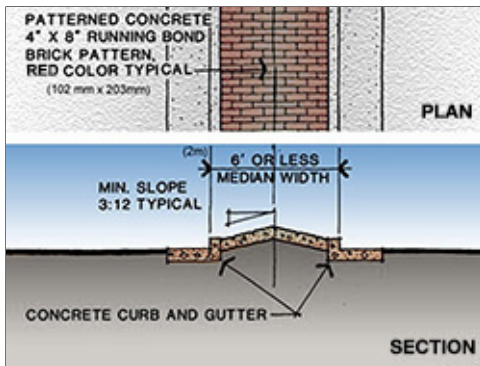

Paved Median



Travis Avenue from Main Gate

1. Arterials are the widest and carry the most vehicles often containing two lanes of traffic in each direction.
2. Minimize stops and turns and on-street parking shall not be allowed at any point along arterial streets.
3. Provide sidewalks on at least one side of arterial streets and both sides of arterial streets in developed areas. Provide a 6 foot buffer between the road and sidewalk where space allows.
4. Limit curb cuts on arterial street to entries into major facilities, building groups and major parking areas.

5. Signs, plantings and street lighting should be added to reinforce the importance of arterial streets.

### B02.1.2. Collector Streets

Applicable  N/A Select number of graphics / images (large: 800 px x 440 px) to insert 1

Image Tool 800 x 440

Applicable  N/A Select number of graphics / images (small: 250 px x 188 px) to insert 1

Image Tool 250 x 188

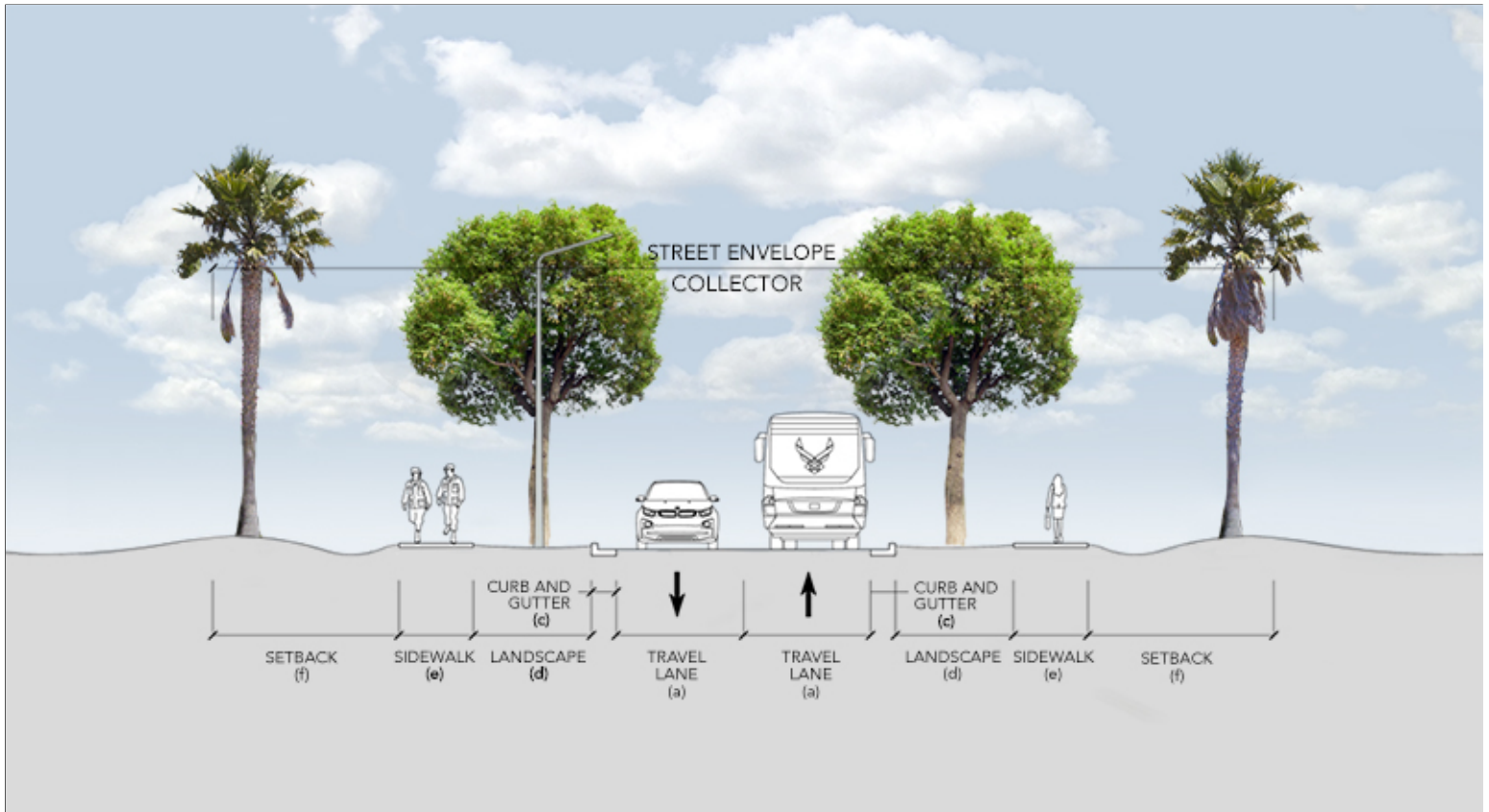

Travel Lane (a): 12' Median (b): N/A Curb and Gutter (c): 2' Landscape (d): 10' Sidewalk (e): 6' Setback (f): Min. 15' or per ATRP



Airlift Drive onto Burgan

1. Collector streets feed local streets to arterial streets.
2. On-street parking is discouraged, but where necessary, may be allowed on one side where collector streets are at least 28 feet wide. Parking shall not interfere with intersections or traffic flow.



3. Minimize the number of curb cuts from driveways and area entrances. Where necessary, locate curb cuts to be at least 40 feet from intersection.

4. Provide sidewalks on at least one side of collector streets. Medians are preferred but not required.

### B02.1.3. Local Streets

Applicable  N/A Select number of graphics / images (large: 800 px x 440 px) to insert 1

Image Tool 800 x 440

Applicable  N/A Select number of graphics / images (small: 250 px x 188 px) to insert 1

Image Tool 250 x 188

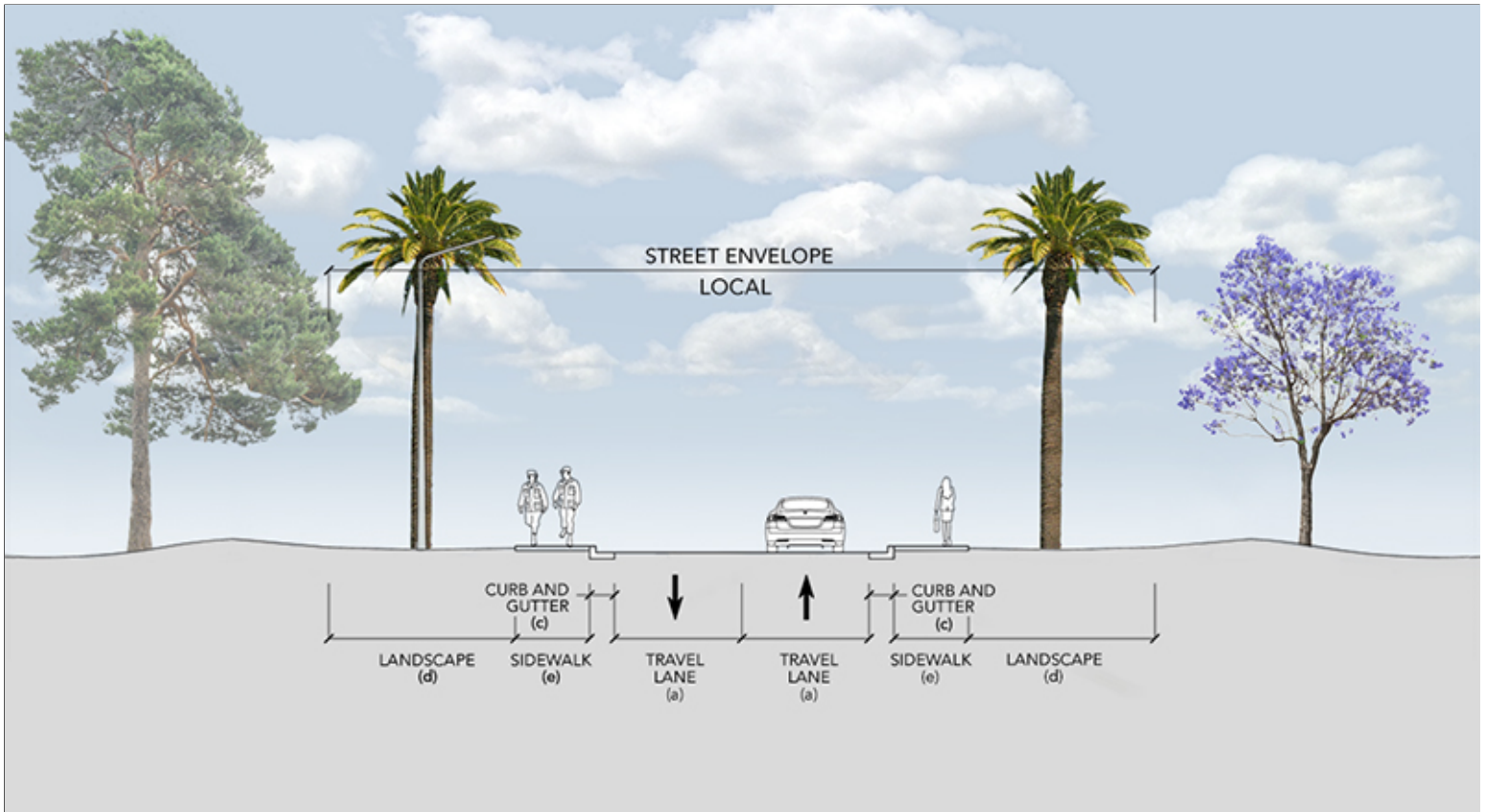

Travel Lane (a): 11' Median (b): N/A Curb and Gutter (c): 1.5' Landscape (d): 15' Sidewalk (e): 6' Setback (f): 15' or per AT/FP requireme



Residential Street in Housing Area

1. Local streets are the narrowest have slower posted speed limits and provide access to individual sites or parking areas.
2. On-street parking and curb cuts for driveways, parking lot entrances and service drives are allowed.

3. Maintain adequate access for large vehicles such as fire trucks, service and delivery vehicles.

#### B02.1.4. Special Routes

Applicable  N/A Large graphics do not apply

Applicable  N/A Select number of graphics / images (small: 250 px x 188 px) to insert 1

Image Tool 250 x 188



View from Hangar Avenue onto Burgan Blvd.

1. Develop all special routes consistently with those adjacent to Group 1 facilities. Special routes include areas that are high visibility and frequented by distinguished visitors.

#### B02.2. Hierarchy of Intersections

Applicable  N/A Large graphics do not apply

Applicable  N/A Small graphics do not apply

1. Provide a hierarchy of intersections to include arterial, arterial-collector, collector, collector-local and local following UFC 3-201-01 and its industry references.
2. Passive systems such as traffic circles are preferred to active systems such as signalized intersections. Aggressively pursue passive systems to lower maintenance requirements and reduce energy use.
3. Use a level of visual quality for an intersection equal to the quality found in the related streetscape, which corresponds to the adjacent Facility Group number.

### B02.2.1. Arterials

Applicable  N/A Large graphics do not apply

Applicable  N/A Select number of graphics / images (small: 250 px x 188 px) to insert 2

Image Tool 250 x 188



Burgan Boulevard and Travis Avenue

1. At arterial intersections adjacent to Group 1, landscaping of native grasses and shrubs may be provided; trees may be included when maintenance and non-potable irrigation is available. Monuments and static displays may be integrated into arterial intersection designs.

### B02.2.2. Arterial/Collector

Applicable  N/A Large graphics do not apply

Applicable  N/A Select number of graphics / images (small: 250 px x 188 px) to insert 1

Image Tool 250 x 188



Airlift Drive onto Burgan Boulevard

1. At arterial/collector intersections adjacent to Group 1, landscaping of native grasses and shrubs may be provided; trees may be included when maintenance and non-potable irrigation is available.

### B02.2.3. Collectors

Applicable  N/A Large graphics do not apply

Applicable  N/A Select number of graphics / images (small: 250 px x 188 px) to insert 1

Image Tool 250 x 188



"T" Intersection

1. At collector intersections adjacent to Group 1, landscaping of native grasses and shrubs may be provided; trees may be included when maintenance and non-potable irrigation is available. Intersections adjacent to Group 2 may be developed similarly, but with less detailing.

### B02.2.4. Special Intersections

Applicable  N/A Large graphics do not apply

Applicable  N/A Small graphics do not apply

1. Develop all special intersections consistently with those adjacent to Group 1 facilities.

### B02.2.5. Street Frontage Requirements

Applicable  N/A Large graphics do not apply

Applicable  N/A Small graphics do not apply

1. Consistently maintain open space buffers following B03.2.3. Preserves.
2. Refer to C06.1.7. Streetscape Landscaping for planting and screen wall requirements along street frontage.

### B02.2.6. Sight Lines

Applicable  N/A Large graphics do not apply

Applicable  N/A Small graphics do not apply

1. Provide adequate sight lines for an effective and safe traffic operation per American Association of State Highway and Transportation Officials (AASHTO) standards and local municipality guidelines.



2. Maintain a 45 foot clear zone free of visual barriers over 18 inches in height at uncontrolled intersections. Maintain a 15 foot clear zone free of visual barriers over 18 inches in height at controlled intersections with vehicle speeds of 30 mph or less.

### B02.3. Street Elements

Applicable  N/A Large graphics do not apply

Applicable  N/A Select number of graphics / images (small: 250 px x 188 px) to insert 2

Image Tool 250 x 188



Coordinated Lighting and Sidewalk



Screening of Parking Areas

1. Emulate the streetscape area's pre-development hydrology using passive and active design features to help sustain the adjacent regionally appropriate landscape. Coordinate with the base Stormwater Management Plan.
2. Employ systems, materials and techniques to maximize streetscape sustainability. Consider pervious paving and reflectivity of surfaces appropriate for the local climate.
3. Install at-grade curbing and/or raised-profile curb and gutter as applicable to direct stormwater to bioswales and rain gardens as source water for vegetation. Do not paint concrete curbing.
4. Provide all on-site utility service lines and equipment below grade when adjacent to Facility Group 1. In routes along Group 2, 3 and 4, when mounting elements such as utility cabinets, communications equipment and water valves above grade is unavoidable, paint these consistently and provide visual screening following Installation Facilities Standards (IFS).
5. Provide traffic control devices including access control point/entry control facility signs, speed limit signs and street name signs following the current edition of the Manual on Uniform Traffic Control Devices (MUTCD) per UFC 3-120-01.
6. Crosswalk markings shall follow the MUTCD for Streets and Highways, current edition. Provide white markings that define the edges of the crosswalk or a tone of lines defining the area of the crosswalk consistent with common practices found in the adjacent municipality.
7. Follow UFC 3-120-01 for directional and wayfinding signs and address both vehicular and pedestrian traffic.
8. Reduce energy consumption and reduce maintenance requirements by providing street lighting only when functionally required to ensure safety and to address antiterrorism following UFC 4-010-01. Ensure the quality and quantities of lighting and fixtures are appropriate for the adjacent Facility Group number.

### B02.3.1. Paving

Applicable  N/A Large graphics do not apply

Applicable  N/A Select number of graphics / images (small: 250 px x 188 px) to insert 1

Image Tool 250 x 188



Typical Bituminous Paving with Concrete Curb

1. Pavement design shall comply with UFC 3-250-01. Ensure appropriate analysis and design of subgrade conditions to promote low maintenance, high performance pavements. Apply all applicable best practices from Appendix B of the UFC.
2. Materials shall be specified in accordance with UFC 3-250-01 and must conform to requirements set forth in the Unified Facility Guide Specifications (UFGS) for concrete and bituminous pavement.

### B02.3.2. Curb and Gutter

Applicable  N/A Large graphics do not apply

Applicable  N/A Select number of graphics / images (small: 250 px x 188 px) to insert 1

Image Tool 250 x 188

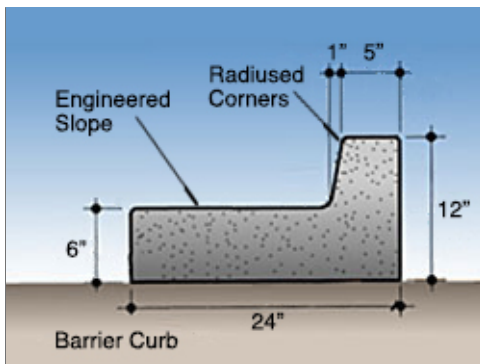

Integral Curb and Gutter

1. Continuous concrete curbs shall be provided at paved roads and parking areas adjacent to Group 1, Group 2 and Group 4 facilities. Asphalt curbs may be used at roads and parking areas adjacent to Group 3 facilities where needed but are not required. Patrol roads and service drives in outlying areas may not require curb and gutter, with ACRB approval.
2. Integral concrete curb and gutter shall be used at areas with drainage (asphalt sloped towards curb). A header curb without gutter shall be allowed in areas if adjacent asphalt is sloped away.
3. A minimum standard curb height of 6 inches shall be consistently maintained. "Rolled" mountable curbs are not allowed.



4. Wheel stops in lieu of curbs are not allowed.

5. Do not paint concrete curbs.

### B02.3.3. Utility Service Elements

Applicable  N/A Large graphics do not apply

Applicable  N/A Select number of graphics / images (small: 250 px x 188 px) to insert 2

Image Tool 250 x 188



Electrical Gear Cabinets with Screening



At-Grade Service Box

1. Provide all utility service lines below grade when streets are adjacent to Facility Group 1.
2. When mounting elements (such as utility cabinets, communications equipment and water valves) above grade is unavoidable, paint these consistently and provide visual screening following Site Development, Landscaping.
3. Overhead service lines along streets adjacent to Facility Groups 2, 3 and 4 are discouraged.

### B02.3.4. Traffic Signs

Applicable  N/A Large graphics do not apply

Applicable  N/A Select number of graphics / images (small: 250 px x 188 px) to insert 1

Image Tool 250 x 188



Typical Street Sign

1. Refer to Exterior Signs, Colors and Types for Traffic Control Devices, which includes signs.

### B02.3.5. Street Lighting

Applicable  N/A Large graphics do not apply

Applicable  N/A Select number of graphics / images (small: 250 px x 188 px) to insert 1

Image Tool 250 x 188



Coordinated Lighting and Landscape

1. Refer to the Lighting section for appropriate applications along streets.

### B02.3.6. Other

Applicable  N/A Large graphics do not apply

Applicable  N/A Small graphics do not apply

## B03. OPEN SPACE / PUBLIC SPACE

Comply with Air Force Corporate Standards for Installation Elements:

<http://afcs.wbdg.org/installation-elements/index.html>

Comply with AF Corporate Standards for Open Space / Public Space:

<http://afcs.wbdg.org/installation-elements/open-space-public-space/index.html>



### B03.1. Plazas, Monuments and Static Displays

Applicable  N/A Select number of graphics / images (large: 800 px x 440 px) to insert 1

Image Tool 800 x 440

Applicable  N/A Select number of graphics / images (small: 250 px x 188 px) to insert 2

Image Tool 250 x 188



Static Display of Aircraft Plaza



Paved Plaza at Building Entrance



Array of Flags

1. Natural features and culturally or historically significant features or events may be recognized and acknowledged with physical elements such as plazas, monuments and static displays. However, limit these elements on the base to ensure judicious use of resources and to reduce ongoing maintenance requirements.
2. Design highly durable plazas, monuments and static displays with a level of quality comparable to Facility Group 1.
3. Link plazas, monuments and static displays to the pedestrian circulation system. Install landscaping, site furnishings and lighting appropriate for the application and local climate following Installation Facilities Standards (IFS).

4. Select systems, products and materials for paving, walls, and structures following IFS.

### B03.1.1. Paved Plazas

Applicable  N/A Large graphics do not apply

Applicable  N/A Select number of graphics / images (small: 250 px x 188 px) to insert 3

Image Tool 250 x 188



Patterned Brick Paver



Combination of Concrete and Brick Pavers



Pervious Paving Used at Fire Station

1. Mitigate heat island by providing high-albedo, shaded plazas. Pervious pavers shall be used on all plazas and courtyards in Facility Groups 1 and 2; use pervious concrete in Groups 3 and 4. The designer shall incorporate appropriate expansion and construction joints.
2. Pavers shall match the color of pavers used on adjacent sidewalks using Terra Cotta as a base standard. Bricks used on plazas shall typically be 4" x 8" size.

### B03.1.2. Sculptures, Markers and Statuary

Applicable  N/A Large graphics do not apply

Applicable  N/A Select number of graphics / images (small: 250 px x 188 px) to insert 1

Image Tool 250 x 188



Cast Stone Marker

1. Relate new sculpture, markers and statuary to the base's architectural design theme. Generally limit these elements to frequently used locations adjacent to Facility Group 1 and highly traveled community pedestrian spaces.
2. All proposed memorials shall follow AFI 36-3108 and be limited to highly deserving individuals or groups as deemed appropriate by the installation leadership. Living memorials (tree plantings / etc.) are discouraged due to added maintenance requirements.



3. Materials used shall match color palette of adjacent structures/spaces, be of permanent nature, be durable and require minimal maintenance.
4. Use LED direct or indirect lighting to accentuate features or enhance an intended effect.
5. Ensure that all sculpture, markers and statuary are honorable and inspiring, provide a sense of place, positively contribute to the base's visual quality, and encourage pride for the community and the US Air Force.

### B03.1.3. Static Display of Aircraft

Applicable  N/A Large graphics do not apply

Applicable  N/A Select number of graphics / images (small: 250 px x 188 px) to insert 1

Image Tool 250 x 188



Ground-Mounted Display

1. Follow IFS base-wide standards for all elements of the display area with specific attention to traffic sight lines, pedestrian circulation, site furnishings, signs, and lighting. Address requirements for the Facility District as well.
2. Generally locate concrete base/foundation structures for static displays below grade.
3. At static displays where pedestrian paths are provided, a minimum of one trash receptacle and one bench shall be provided. Receptacle and bench design must conform to IFS requirements.

## B03.2. Grounds and Perimeters

Applicable  N/A Select number of graphics / images (large: 800 px x 440 px) to insert 1

Image Tool 800 x 440

Applicable  N/A Select number of graphics / images (small: 250 px x 188 px) to insert 2

Image Tool 250 x 188



Berm and Landscape Buffer Preserves Views to Open Space



Landscaped Open Space



Open Space at Perimeter Fence

1. Provide formal spaces for parade and review functions, recreational areas and parks following the base's Installation Development Plan (IDP) and Installation Facilities Standards (IFS). Refer to the Site Furnishings topic for additional information.
2. Maintain preservation areas following the IDP and IFS.
3. Comply with UFC 4-010-01 DoD Minimum Antiterrorism Standards for Buildings and UFC 4-022-03 Security Fences and Gates for all elements associated with the base's gates and perimeter fence.



4. Identify and describe base-wide utility corridors in the IDP.
5. Base-wide utility infrastructure shall be inconspicuous. Bury utility service lines below grade when adjacent to Facility Group 1 and when economically feasible for Facility Groups 2, 3 and 4. When service lines are located above grade, create an ordered, coordinated appearance.
6. Follow the requirements of this IFS regarding all utility structures and service lines located above grade that visually impact the installation.
7. Where screening of utility equipment and structures is provided, allow adequate and proper clearance for safety and maintenance.
8. Reduce visual clutter and visual impact of the following items through a combination of careful placement, screen walls, landscaping and painting:
  - Electrical switch-stations.
  - Sewage lift stations.
  - Water well pumps, storage tanks and/or related structures.
  - Gas piping, meters and similar incidental items.
  - Above ground fuel storage tanks.
  - Any ground-mounted freestanding utility item exposed to view.
9. Larger structures such as electrical switch-stations, sewage lift stations, fuel storage tanks and mechanical/electrical equipment shall be screened from view, using materials, forms, and colors in the screen walls which match those respective design elements present at adjacent buildings.
10. Paint above-ground equipment and associated components such as electrical piping or exposed plumbing lines dark bronze.
11. Maintain currently buried utility service lines as a visual asset.
12. Bury the following exposed above-grade items in future projects when economically feasible:
  - Electrical power grid and service lines.
  - Telephone lines.
  - Cable TV lines.
  - Communications lines.
  - Exterior lighting service lines.
  - Any similar system of above-ground lines serving the base.
13. Consolidate and enclose service utility lines in underground utility corridors when feasible. Create routes along the inside edge of parking lot islands.

### **B03.2.1. Parade Grounds**

Applicable  N/A Large graphics do not apply

Applicable  N/A Small graphics do not apply

1. Follow UFC 3-201-02, Appendix B for the planning and design process and criteria for parade grounds.
2. Establish and maintain parade grounds only where there is a confirmed need and provide landscape materials appropriate for the locale following IFS.
3. Bleachers may be installed only when there is a documented requirement at parade grounds. Nonferrous metals that do not require painting or going maintenance are preferred. The Base Civil Engineer shall determine quantities, sizes, and products on a case basis.

### B03.2.2. Parks

Applicable  N/A Select number of graphics / images (large: 800 px x 440 px) to insert 1

Image Tool 800 x 440

Applicable  N/A Select number of graphics / images (small: 250 px x 188 px) to insert 1

Image Tool 250 x 188



Water Feature as a Central Focus for Park



Compatible Pavilion

1. Bleachers may be installed only when there is a documented requirement at parks and fields for recreational events. Follow guidance under Parade Grounds.
2. Picnic pavilions may be provided in parks where there is a documented need.
3. Picnic pavilions shall be constructed of durable materials matching the quality and style of finish of the adjacent Facility Group.

### B03.2.3. Preserves

Applicable  N/A Large graphics do not apply

Applicable  N/A Small graphics do not apply

1. Preserve areas adjacent to runways, taxiways, aprons, golf course roughs, storage areas, antenna facilities, and ammunition storage areas, as open space.
2. Provide minimal maintenance with mowing as needed for controlling bird behavior for airfield safety, or eliminating fire hazards.

### B03.2.4. Perimeter Fence

Applicable  N/A Large graphics do not apply

Applicable  N/A Select number of graphics / images (small: 250 px x 188 px) to insert 1

Image Tool 250 x 188



Base Standard Fencing

1. Design, install and maintain the base's perimeter fence following UFC 4-022-03.
2. Stringently comply with AT / FP requirements following UFC 04-010-01 for all spaces adjacent to the base's perimeter fence and all gates.
3. Fencing, gates and other elements that are associated with the main gates shall be a level of quality equivalent to Facility Group 1.
4. Maintain a positive visual quality along the traffic corridor on both sides of the main gates. Specifically address pedestrian access, circulation and common areas.



## C. SITE DEVELOPMENT

Comply with Air Force Corporate Standards for Site Development:  
<http://afcs.wbdg.org/site-development/index.html>

### C01. SITE DESIGN

Comply with Air Force Corporate Standards for Site Development:  
<http://afcs.wbdg.org/site-development/index.html>

Comply with AF Corporate Standards for Site Design / NEPA:  
<http://afcs.wbdg.org/site-development/site-design-nepa/index.html>

#### C01.1. Site Design Considerations

Applicable  N/A Select number of graphics / images (large: 800 px x 440 px) to insert 1

Image Tool 800 x 440

Applicable  N/A Select number of graphics / images (small: 250 px x 188 px) to insert 3

Image Tool 250 x 188



Westwind Inn Base Lodging with Clearly Defined Pedestrian and Vehicular Circulation



Rendering of Site with Facilities



Conceptual Site Plan



Site Analysis Diagram

1. Collect documentation to validate approvals and completion of the NEPA process.
2. Ensure site design compliance with the Installation Development Plan (IDP) and its component plans and Installation Facilities Standards (IFS).
3. Promote integrated design with on-site solutions such as engineered small-scale hydrologic controls versus base-wide infrastructure; consider open space, natural features, bioswales, building roofs, streets, and paved surfaces.
4. Limit the impact of development on land and water resources. All site elements and infrastructure shall reinforce an image of sustainability, with reduced energy demand, renewable-energy usage, and water conservation.
5. Consider energy conservation during site design for the following categories: building and site lighting, auxiliary systems and equipment (refrigerators, elevators, etc.), building envelope, electric power and distribution, HVAC systems and equipment, service hot water, energy management (metering, EMCS).
6. Coordinate on-site renewable-energy systems and components to minimize area requirements and maximize efficiencies. Appropriately buffer and screen these and other mechanical systems and equipment.
7. New building projects should preserve open space and protect natural habitat.
8. Conform to existing topography to the greatest extent possible and use slopes to increase site and building efficiencies. Design sites to minimize irrigation and impacts to stormwater runoff.
9. Carefully study new project sites to identify the character of adjacent buildings, streets, landscaping, and site design elements. Reinforce the existing character in new site design.
10. Consider relationships to adjacent facilities and district / centralized heating and cooling infrastructure and cost effectively connect building systems to harvest heat, grey water or other beneficial byproducts.
11. Minimize existing and planned obstructions from landscaping, structures, topography, and adjacent developments to preserve solar access and natural ventilation.
12. Purposefully integrate service access, receiving and storage areas to eliminate the need for visual screening.
13. Appropriately connect to the base network of streets, sidewalks and trails using drive aisles, parking areas, walkways, paths, and bicycle routes addressing both vehicles and pedestrians.
14. Applicably coordinate heat island mitigation in paving and roof designs when implementing an integrated approach to stormwater management.
15. Designated Tobacco Areas shall be sited and approved by 60 CES/CENM in compliance with AFI40-102, Tobacco Free Living.



## C01.2. Building Orientation

Applicable  N/A Select number of graphics / images (large: 800 px x 440 px) to insert 1

Image Tool 800 x 440

Applicable  N/A Small graphics do not apply

### DRIVING FACTORS

- |  |  |  |   |
|--|--|--|---|
| • Optimal solar orientation of the building.   | • Maximize the daylight & desirable views.       | • Meet the required AT/FP standoff distance          | • Create a unified campus                       |
| • Main entrance from Pepperrell street.        | • Saving existing vegetation and trees           | • Separation between staff/public/materials entrance | • Outdoor healing environment                   |
| • Addressing the orientation of the future ACC | • Visibility of the new facility from main roads | • Required parking spaces for public and staff       | • Implementation of landscape zones A, B, C & D |

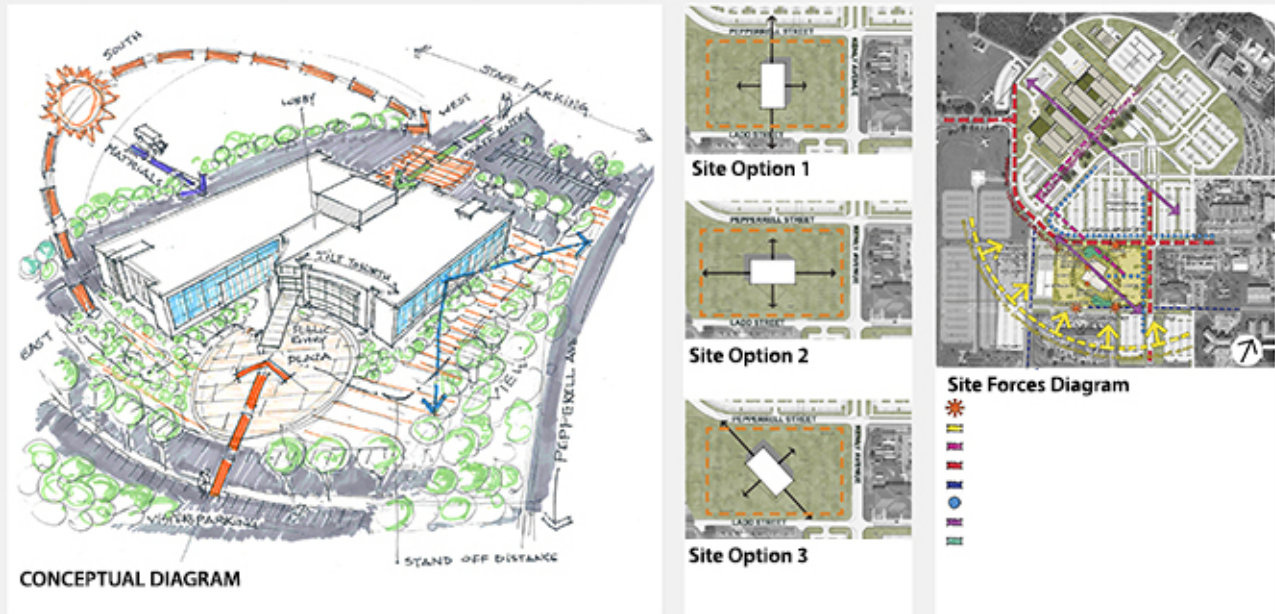

Conceptual Site Analysis and Site Design Diagram

1. Ensure the site will accommodate optimum requirements for building orientation, which is with the long axis parallel to the east/west direction for rectilinear CONUS buildings.
2. Meet Installation Facilities Standards (IFS) requirements for the locations of the building's passive and renewable-energy systems --including geothermal and solar systems --and exterior shading systems.
3. Locate the building(s) and permitted ancillary structures to promote solar gain, solar shading, natural ventilation, rainwater harvesting, wind buffering and other beneficial passive systems. Consider natural ventilation during the design of HVAC systems.
4. Consider relationships to adjacent sites and their facilities and infrastructure, and cost effectively integrate building systems to harvest heat, grey water or other beneficial byproducts.
5. Consider the "public side" of the building, its views and the location of the main entrance.

## C02. UTILITIES

Comply with AF Corporate Standards for Site Development:  
<http://afcs.wbdg.org/site-development/index.html>

Comply with AF Corporate Standards for Utilities:  
<http://afcs.wbdg.org/site-development/utilities/index.html>

## C02.1. Utility Components

Applicable  N/A Large graphics do not apply

Applicable  N/A Select number of graphics / images (small: 250 px x 188 px) to insert 3

Image Tool 250 x 188



Landscape Screening



Flush with Grade Mounting



Gas Service Screening

1. Provide all on-site utility service lines below grade for Facility Group 1; when mounting elements (such as utility cabinets, communications equipment and water valves) above grade is unavoidable, paint these consistently and provide visual screening following Installation Facilities Standards (IFS).
2. Provide installation of utility infrastructure to support near term and future electric vehicle charging stations.
3. Define all service entry points into the building and route distribution below grade into an interior space within the facility; exposed conduits, cables and wires on exterior walls are not permitted for Facility Group 1.
4. Include consideration of appropriate placement of meters in support of Automated Revenue Management Services (ARMS).
5. Limit exterior mechanical distribution systems such as exterior steam, chilled water, and hot water distribution to Group 3 facilities; when required for Group 1 and 2 facilities integrate with the architecture and provide visual screens following IFS.
6. Direct roof drainage to underground collection when feasible or provide splash blocks/paved channels to intercept roof drainage at grade.

## C03. PARKING AREAS

Comply with AF Corporate Standards for Site Development:

<http://afcs.wbdg.org/site-development/index.html>

Comply with AF Corporate Standards for Parking Areas:

<http://afcs.wbdg.org/site-development/parking-areas/index.html>



### C03.1. Configurations and Design

Applicable  N/A Select number of graphics / images (large: 800 px x 440 px) to insert 1

Image Tool 800 x 440

Applicable  N/A Select number of graphics / images (small: 250 px x 188 px) to insert 3

Image Tool 250 x 188



Facility Group 2 Site Development with Adjacent Parking

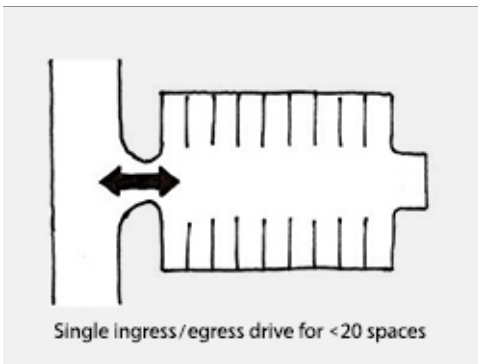

Small Lot Configuration

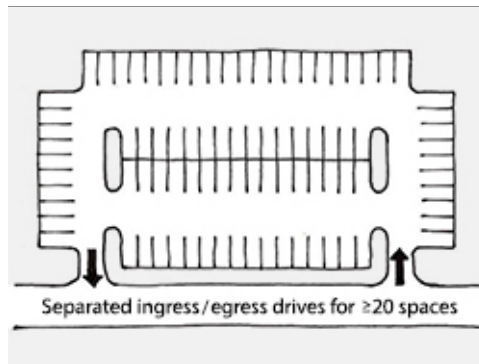

Large Lot Configuration

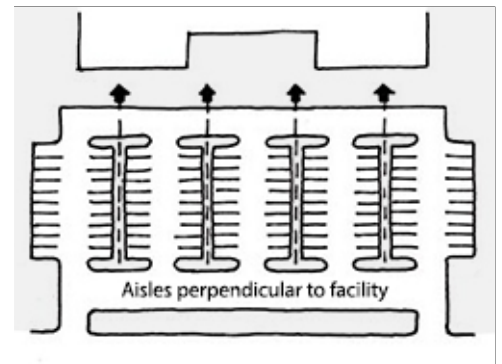

Facility Group 1 Configuration

1. Evaluate adjacent sites and cost-effectively consolidate parking areas to maximize efficient use. Parking layout must address maintenance, safety, and accessibility.
2. Generally envision on-site parking as a series of small connected singular areas selectively placed around the facility served, rather than a single large area; buffer parking areas from the facility main entrance with a transition space and provide drop-offs to decrease close-in parking.
3. Comply with IFS standards while meeting AT/FP requirements. Coordinate suitable landscape or barriers integrated with walls and fences to ensure adequate force protection.

4. Integrate at-grade and raised-profile curbing, permeable paved areas, and parking islands with the stormwater system and direct stormwater to bioswales and rain gardens as source water for regionally appropriate native vegetation.
5. Define pedestrian access with approved hardscape and provide shading along the primary path from the parking area to the main entrance of the building. Wherever possible, provide tree shading or shade canopy for parking areas. Consider cost-effectively integrating solar photovoltaic arrays into covered parking structures.
6. Use shrubs in groupings and landscaped berms around the perimeter to soften the impact of parking areas. Avoid the use of hedges outlining parking areas. Provide a greenbelt of 20 feet from parking lots to streets.
7. Use decomposed granite or approved rock in medians and islands for ease of maintenance. Allow for breaks in the medians where necessary for pedestrian cross circulation. Provide medians for every four rows of vehicle and planting islands for every 20 stalls where there is adequate space. Coordinate layout for light poles with landscape islands and minimize their number to provide the required illumination.
8. Accessible parking spaces shall be marked according to UFC 3-120-01 and its references in ABAAS and the MUTCD.
9. Designate spaces with approved curbsmounted signs. Use the 90-degree parking configuration when possible.
10. Designate preferred parking spaces for electric vehicles and carpools near the main entrance. Consider locations and requirements of near term and future electric vehicle charging stations.
11. Reserved parking is discouraged except GOVs assigned to the adjacent facilities and for Facility Group 1.
12. On-street parking is discouraged except in existing low traffic areas or residential areas. When used, provide approved on-street parking configurations following UFC 3-201-01.
13. Access and service drives should accommodate the largest vehicle serving the facility.

### C03.1.1. Paving and Striping

Applicable  N/A Large graphics do not apply

Applicable  N/A Select number of graphics / images (small: 250 px x 188 px) to insert 3

Image Tool 250 x 188



Asphaltic Concrete Paving



Integrated Landscape Medians



Typical White Striping



**Facility Group 1** paving materials shall be as follows.

Primary: Asphaltic concrete

Secondary: Concrete

Accent: Permeable pavers

**Facility Group 2** paving materials shall be as follows.

Primary: Asphaltic Concrete

Secondary: N/A

Accent: N/A

**Facility Group 3** paving materials shall be as follows.

Primary: Concrete where operationally required

Secondary: Asphaltic Concrete

Accent: N/A

**Facility Group 4** paving materials shall be as follows.

Primary: Asphaltic Concrete

Secondary: N/A

Accent: N/A

1. All new parking lots in Groups 1 and 2 shall be constructed of asphaltic concrete paving.
2. Porous paving may be considered on a case basis.
3. Cost-effectively provide light-colored concrete to reduce heat island effect; otherwise install asphaltic concrete paving. Dirt, gravel, and grass lots are not allowed.
4. Use consistent striping, angles and stall sizes in all parking areas.
5. All parking shall be marked with white stripes of paint or applied vinyl coatings. Red or yellow markings shall only be used for safety purposes and must be kept to a minimum. All lines shall be four inches (4") wide.

### C03.1.2. Curbing

Applicable  N/A Large graphics do not apply

Applicable  N/A Select number of graphics / images (small: 250 px x 188 px) to insert 2

Image Tool 250 x 188

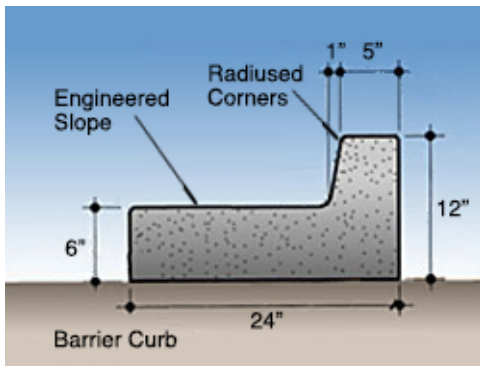

"Barrier" Curb

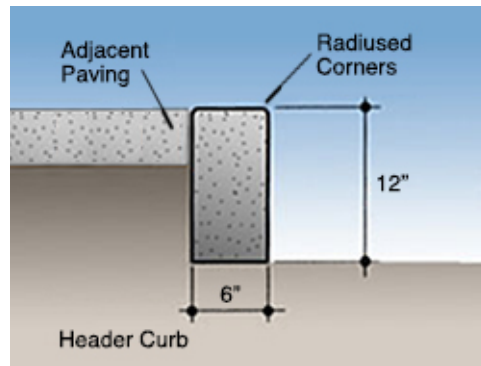

Header Curb

**Facility Group 1** curbing / edging materials shall be as follows.

Primary: Concrete, formed, 6" high minimum

Secondary: N/A

Accent: N/A

**Facility Group 3** curbing / edging materials shall be as follows.

Primary: Concrete, formed, 6" high minimum

Secondary: N/A

Accent: N/A

**Facility Group 2** curbing / edging materials shall be as follows.

Primary: Concrete, formed, 6" high minimum

Secondary: N/A

Accent: N/A

**Facility Group 4** curbing / edging materials shall be as follows.

Primary: Concrete, formed, 6" high minimum

Secondary: N/A

Accent: N/A

1. Define all parking lots with either raised profile or at-grade curbing to promote drainage and protect paving edges. Group 3 parking areas and service yards are not required to have edge curbing but dirt areas directly adjacent to parking areas and driveways shall be compacted base course or decomposed granite, extending 6' to 8' from paved areas.
2. Integrate curbing to direct storm water to bioswales and rain gardens as source water for regionally appropriate native vegetation.
3. Wheel stops are not permitted except at locations where car bumpers could contact adjacent items such as poles, signs or pedestrians.

### C03.1.3. Internal Islands and Medians

Applicable  N/A Large graphics do not apply

Applicable  N/A Select number of graphics / images (small: 250 px x 188 px) to insert 3

Image Tool 250 x 188



Coordinated Geometries



Central Landscape Island



Header Curb at Island

1. Install landscape islands and medians as visual breaks, to reduce heat island effects and to accommodate bioswales and rain gardens. Coordinate suitable landscape or barriers integrated with walls and fences to ensure adequate force protection.
2. When lighting is necessary, contain fixture bases within medians or internal landscape islands.



### C03.2. Parking Structures

Applicable  N/A Large graphics do not apply

Applicable  N/A Small graphics do not apply

1. Parking structures are encouraged in land-constrained locations when economically feasible.
2. Consider near term and future electric vehicle charging stations and renewable energy generation development during the analysis and design.
3. Consider opportunities for integrating parking structures into multi-use developments with pedestrian-oriented uses located on the ground floor and parking on upper levels; ensure AFTP guidelines are fully addressed.
4. Structures may be constructed below grade with roofs serving as vegetated areas or plazas.

### C03.3. Connectivity

Applicable  N/A Select number of graphics / images (large: 800 px x 440 px) to insert 1

Image Tool 800 x 440

Applicable  N/A Small graphics do not apply



Central Pedestrian Pathway Linking Parking Areas to Pavilion and Main Entrance

1. Refer to the Installation Development Plan (IDP) for locations of transit stops and pedestrian and cycling networks; provide appropriately sized sidewalks and bike paths to connect facilities and users to these networks.
2. Provide amenities such as rain and shade shelters, trees, and benches to encourage and facilitate use of public transportation.
3. Evaluate the IDP for the current and planned network of roads and optimally develop vehicular access to and from the site.

- Define pedestrian access with approved hardscape, provide shading and provide safe, efficient travel from vehicles along the primary path from the parking area to the main entrance of the building. Emphasize building main entrance in alignment of landscape median and pedestrian paths.

#### C04. STORMWATER MANAGEMENT

Comply with AF Corporate Standards for Site Development:

<http://afcs.wbdg.org/site-development/index.html>

Comply with AF Corporate Standards for Stormwater Management:

<http://afcs.wbdg.org/site-development/stormwater-management/index.html>

##### C04.1. Stormwater Requirements

Applicable  N/A Large graphics do not apply

Applicable  N/A Select number of graphics / images (small: 250 px x 188 px) to insert 3

Image Tool 250 x 188



Curb Inlet



Inlet Setback from Crosswalk



Drainage Toward Perimeter

- Design all stormwater systems including retention ponds, detention areas, channels, etc. as on-site amenities that are consistent with natural systems and drainage patterns, that help sustain the base landscape with beneficial functionality and that provide aesthetic appeal; coordinate with the base Stormwater Management Plan.
- Permeable paving may be used in areas that are not subjected to severe freeze-thaw cycles.
- When underground drainage systems are required establish a maintenance program to include removal of sediments and debris; inspect joints seasonally for alignment to prevent leakage and the development of voids and surface failures.
- Cost-effectively integrate stormwater systems with ATRP measures.

#### C05. SIDEWALKS, BIKEWAYS AND TRAILS

Comply with AF Corporate Standards for Site Development:

<http://afcs.wbdg.org/site-development/index.html>

Comply with AF Corporate Standards for Sidewalks, Bikeways and Trails:

<http://afcs.wbdg.org/site-development/sidewalks-bikeways-trails/index.html>



## C05.1. Circulation and Paving

Applicable  N/A Select number of graphics / images (large: 800 px x 440 px) to insert 1

Image Tool 800 x 440

Applicable  N/A Select number of graphics / images (small: 250 px x 188 px) to insert 6

Image Tool 250 x 188



Entrance Feature Aligned with Sidewalks



Intersection of sidewalks



Integrated Landscape



Group 2 Crosswalk with Colored Pavers



Concrete Paving with Tile Accent Color



Colored Pavers at Curb Cut



Rock Paving at Recreational Trail

**Facility Group 1** sidewalks, plazas, and courtyards paving materials shall be as follows.

Primary: Pervious Pavers

Secondary: Concrete Edging

Accent: N/A

**Facility Group 2** sidewalks, plazas, and courtyards paving materials shall be as follows.

Primary: Pervious Pavers

Secondary: Concrete Edging

Accent: N/A

**Facility Group 3** sidewalks, plazas, and courtyards paving materials shall be as follows.

Primary: Permeable concrete

Secondary: N/A

Accent: N/A

**Facility Group 4** sidewalks, plazas, and courtyards paving materials shall be as follows.

Primary: Permeable concrete

Secondary: N/A

Accent: N/A

1. Maintain efficient geometry and accessibility to connect building entrances to adjacent parking areas and activity areas and to the base transportation system following AT/FP. Efficiently use materials to optimize life-cycle costs and to minimize maintenance.
2. Generally conform horizontal layouts of sidewalks to the geometric configuration of adjacent buildings, streets, parking lots, and other adjacent related site amenities. Occasional meanders and/or jogs may be included to capture views, to coordinate with landscaping or accommodate site constraints.
3. Walks in parking areas shall provide a direct path using "safe islands" and "peninsulas" to encourage safety. Walks parallel to streets shall follow streetscape guidelines. Clearly mark pedestrian crossings at vehicular routes.
4. Mitigate heat island by providing high-albedo, shaded sidewalks. Pervious pavers shall be used on all sidewalks, plazas and courtyards in Facility Groups 1 and 2; use pervious concrete in Groups 3 and 4. The designer shall incorporate appropriate expansion and construction joints.
5. Only experienced contractors will install pervious pavements.
6. Consider an integrated approach that could include stormwater management (permeable surfaces) and complement the design of the storm drainage system when appropriate.
7. Pedestrian paths should be at least 5' in width to allow for comfortable side-by-side walking.
8. Sidewalks leading to a building main entrance and at the interior of parking lots shall be a minimum width of 6'. Walks greater than 10' wide may be used at high-density pedestrian areas where volumes of traffic justify added material.



9. Where cars park adjacent and head-in to the sidewalk and wheel stops are not used, such perimeter walks shall be increased to a minimum width of 8' to accommodate overhangs of the parked vehicles.
10. All sidewalks shall have positive drainage to prevent ponding of water or ice accumulation with slopes ranging from 2.1% to 4.2%. Walks with a slope greater than 4.2% shall be designed as ramps following accessibility guidelines. All walks shall have a minimum cross slope of 2.1%.
11. Pavers shall conform to the following range of color: terra cotta. Pavers used on walks shall typically be 4" x 8" in size; other sizes and shapes may be approved by 60 CES/CENM on a case by case basis.
12. Connect to the bicycle circulation system and provide bicycle parking with a suitable means for securing bicycles following IFS. Consider changing/shower facilities for use by cyclists.
13. Refer to the Installation Development Plan for future trails, bicycle paths, and sidewalks.

### C05.1.1. Ramps and Stairs

Applicable  N/A Large graphics do not apply

Applicable  N/A Select number of graphics / images (small: 250 px x 188 px) to insert 2

Image Tool 250 x 188



Integrated Access



Stair Wall and Railing

1. Use ramps instead of stairs for sidewalks, bikeways and trails and at all buildings where possible. Where steps are unavoidable, follow UFC 1-200-01 and its references to the international Building Code.

### C05.1.2. Lighting

Applicable  N/A Large graphics do not apply

Applicable  N/A Select number of graphics / images (small: 250 px x 188 px) to insert 3

Image Tool 250 x 188



Parking Lot Lighting



Group 2 Uplighting



Group 2 Entrance Lighting



1. Provide lighting for all stairs and landings where traffic warrants.
2. Refer to the Lighting section for path lighting along sidewalks, bikeways and trails.

## C06. LANDSCAPE

Comply with AF Corporate Standards for Site Development:  
<http://afcs.wbdg.org/site-development/index.html>

Comply with AF Corporate Standards for Landscape:  
<http://afcs.wbdg.org/site-development/landscape/index.html>

### C06.1. Climate-based Materials

Applicable  N/A Select number of graphics / images (large: 800 px x 440 px) to insert 1

Image Tool 800 x 440

Applicable  N/A Small graphics do not apply



Drought Tolerant Planting with Colorful Accents at Building Entrance

1. Use only native, naturally occurring, drought tolerant indigenous plant species (including grasses) appropriate for the locale to promote energy efficiency and water conservation, preserve drainage patterns, inhibit erosion, improve air quality, lower maintenance, and add beauty. In high-visibility areas, the use of non-natives may be used as approved by 60 CES/CEN. Coordinate with 60 CES/CEN for list of approved plants.
2. Follow details and specifications of the American Standard for Nursery Stock, current edition.

## C06.1.1. Landscape Design Concept

Applicable  N/A Large graphics do not apply

Applicable  N/A Select number of graphics / images (small: 250 px x 188 px) to insert 6

Image Tool 250 x 188



Indigenous Species



Grasses and Trees as Primary Palette



Trees as a Focal Point



Trees and Shrubs Defining Sidewalk



Trees and Integrated Lighting



Native Grasses in Open Space

1. Develop, maintain and implement a climate-based plant list with landscape features using a regionally appropriate palette of materials to promote energy efficiency, preserve drainage patterns, inhibit erosion, improve air quality, lower maintenance and add beauty. Follow UFC 3-201-02 Landscape Architecture.
2. Landscaping is required for all newly developed sites and facilities; preserve existing native landscape where possible and avoid overplanting.
3. Concentrate landscaping in Facility Group 1 and along major thoroughfares and integrate these landscaped areas into the base's stormwater management plan. Refer to the Streetscape Envelope Standards in this IFS.
4. All Facility Group 1 and 4 sites shall be landscaped at their entire perimeter; limit formal planting arrangements to formal spaces typically associated with Group 1. Landscape public spaces near the main entrances of Group 1 facilities.
5. Facility Group 2 and 3 sites may have a native undisturbed landscape except at the main entrances of Group 2, which should be newly landscaped.
6. Facility plantings shall follow the Installation Facilities Standards (IFS) plant list, which is based on the specific microclimates created by the adjacent building; shadow areas, protected areas, zones adjacent to thermal mass, and availability of rainwater and/or grey water.
7. Provide open spaces as transitions between developed and native areas that promote quality of life and provide visual relief and allow walkable connections to the transportation system.



8. Return suitable areas to a natural state to minimize and, whenever possible, eliminate ground maintenance requirements; expand prairie areas where appropriate with native plants to eliminate mowing and maintenance requirements.
9. In tree clusters replace grass with naturalized shrub beds and leaf litter mulch to eliminate mowing requirements.
10. Use plantings in open spaces to reinforce the space as a visual asset.
11. Consider landscape windbreaks when suitable for the local climate.
12. Integrate security requirements into the landscape design. Coordinate the heights of trees and shrubs and note restrictions for plantings following UFC 4-010-01, DoD Minimum Antiterrorism Standards for Buildings.
13. Berms may be used as an integral part of the overall landscape strategy for screening, security and/or visual interest.

### C06.1.2. Xeriscape Design Principles

Applicable  N/A Large graphics do not apply

Applicable  N/A Select number of graphics / images (small: 250 px x 188 px) to insert 3

Image Tool 250 x 188



Xeric Flowering Perennials



Drought Tolerant Planting in Full Sun



Low-Water Groundcover

1. Apply xeriscape principles following UFC 3-201-02, Landscape Architecture, Appendix B, and Air Force Corporate Facilities Standards.
2. Facility plantings are encouraged to use native plant species and to consider specific microclimates created by the adjacent building: shadow areas, protected areas, zones adjacent to thermal mass, and availability of rainwater and/or grey water.



### C06.1.3. Minimizing Water Requirements

Applicable  N/A Large graphics do not apply

Applicable  N/A Select number of graphics / images (small: 250 px x 188 px) to insert 6

Image Tool 250 x 188



Shrubs with Bark Mulch



Low-Water Planting at Foundation



Native Grasses



Shrubs and Limited Turf Areas



Raised Planter



Landscape Beds and Container Planting

1. Reasonably reduce demand on potable water while seeking opportunities to increase alternative water sources for irrigation. Reduce or eliminate the use of potable/domestic water for purposes of landscape architecture maintenance, consistent with existing legal or contractual obligations, and prohibit potable-water irrigation in new construction beyond establishment following current DoD and Air Force policy.

## C06.1.4. Plant Material Selection

Applicable  N/A Large graphics do not apply

Applicable  N/A Select number of graphics / images (small: 250 px x 188 px) to insert 6

Image Tool 250 x 188



Vertical Proportions Adjacent to Tall Walls



Vibrant Form and Bold Color



Soft Textures and Neutral Color

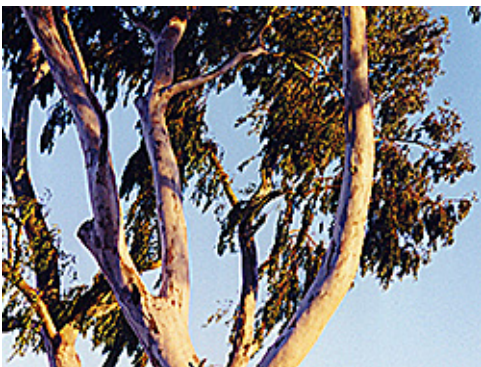

Heavily Textured Exfoliating Bark



Drought Tolerant Species



Groundcover Integrated with Trees

1. Use only native, naturally occurring plant materials including grasses or turf suited for the local climatic conditions in the landscape design; potable-water irrigation systems are discouraged beyond the establishment period.
2. New facilities are encouraged to use native plant species as indicated on the plant list available from 60 CES.
3. Trees should be the focus of landscape plantings and, where possible, should be a mix of deciduous and evergreen species for variety; provide tree grates when appropriate and use tree guards on smaller trees.
4. Ground covers are only recommended when minimal maintenance is required.
5. Turf areas should be limited to those that can be sustained by natural rainfall or grey water (non-potable) irrigation systems; turf may be defined by at-grade concrete mow strips to lessen maintenance.
6. Analyze soils and provide organic amendments as needed to improve plant growth and conserve water.
7. All plant material shall have one-year warranty and is subject to approval by the Base Civil Engineer.



### C06.1.5. Water Budgeting (Hydrozones)

Applicable  N/A Large graphics do not apply

Applicable  N/A Select number of graphics / images (small: 250 px x 188 px) to insert 3

Image Tool 250 x 188



Segregated Areas into Hydrozones



Varied Irrigation Requirements



Definition of Turf Area

1. Comply with DoD and Air Force policy on potable-water irrigation systems.
2. Provide irrigation systems in new construction to establish plant materials following "Water for Landscaping" in UFC 1-200-02. Note the climate zone and annual rainfall for the locale.
3. New buildings shall cost-effectively integrate a grey-water reclamation system following UFC 1-200-02, which provides source water for an automatic drip irrigation system; connect adaptive plantings adjacent to facilities to a grey-water irrigation system when available and discontinue the use of potable water for irrigation after the establishment period.
4. Provide irrigation design following UFC 3-201-02. Install drip irrigation products and components following UFGS Section 32 84 24 Irrigation Sprinkler Systems. Match the color of valve box lids to the adjacent ground treatment (i.e. green at turf & native seed areas, brown at wood mulch & rock areas).
5. Life cycle cost-effectively equip irrigation systems to sense soil moisture, rainfall and wind to minimize unnecessary watering; incorporate drip irrigation systems as the primary source.

### C06.1.6. Base Entrance Landscaping

Applicable  N/A Large graphics do not apply

Applicable  N/A Select number of graphics / images (small: 250 px x 188 px) to insert 3

Image Tool 250 x 188



Minimal Planting at Facilities



Ornamental Mass Planting along Fence



Delicate Neutral Flowering Shrub



1. At the main gate, reinforce a sense of arrival through a well-designed concentration of landscape elements consistent in visual quality with Facility Group 1.
2. Ensure landscaping has seasonal features with spring and fall color and a combination of evergreen and deciduous trees and shrubs for winter interest.
3. Integrate base signs and street and pedestrian lighting whenever feasible.

### C06.1.7. Streetscape Landscaping

Applicable  N/A Large graphics do not apply

Applicable  N/A Select number of graphics / images (small: 250 px x 188 px) to insert 3

Image Tool 250 x 188



Trees and Grasses as Principal Materials



Limited Turf Area



Coordinated Street Elements

1. Provide landscape designs with plant materials appropriately representing the level of quality of the adjacent Facility Group number. Refer to the Installation Elements section.
2. Select a variety of regionally appropriate streetscape plantings and grading to create a visual interest.

### C06.1.8. Pedestrian Circulation Landscaping

Applicable  N/A Large graphics do not apply

Applicable  N/A Select number of graphics / images (small: 250 px x 188 px) to insert 3

Image Tool 250 x 188



Tress Defining Space



Shrubs Defining Sidewalk



Turf Area at Group 1

1. Define walkways with landscaping where appropriate.
2. Provide rest areas along the pedestrian circulation network with human-scaled deciduous shade trees. Supplement tree plantings with finely textured shrubs when appropriate for the climate.



3. Provide wind breaks where required.

### C06.1.9. Parking Lot Landscaping

Applicable  N/A Select number of graphics / images (large: 800 px x 440 px) to insert 1

Image Tool 800 x 440

Applicable  N/A Select number of graphics / images (small: 250 px x 188 px) to insert 6

Image Tool 250 x 188



Primary Parking Access Drive Aligning with Building Entrance Feature



Landscape Medians in Group 2



Trees and Shrubs Providing Screening



Low Level Drought Tolerant Planting





Trees, Shrubs and Limited Turf Area



Shrubs Defining Sidewalk



Accent Planting at Curb Cut

1. Integrate appropriate landscaping elements into parking areas to visually soften the appearance at a minimum rate of 10-15 percent of the total area.
2. Avoid trees that drop sap, fruit, or seeds, and use long-lived species; keep trees trimmed, removing dead and dying trees or branches.
3. Provide planting in islands within parking lots for shade and appeal following IFS and the base stormwater management plan.
4. Rain garden islands shall be landscaped to receive rainwater runoff from adjacent impervious parking areas to be absorbed into the ground/planting bed. Native plants and groundcovers are recommended within the rain garden areas, which can survive without supplemental irrigation once established.

### C06.1.10. Screen/Accent Landscaping

Applicable  N/A Large graphics do not apply

Applicable  N/A Select number of graphics / images (small: 250 px x 188 px) to insert 6

Image Tool 250 x 188



Accent Planting at Masonry Screen Wall



Landscape Hedge for Visual Screening



Accent Planting at Concrete Screen Wall





Accent Planting at Bus Shelter

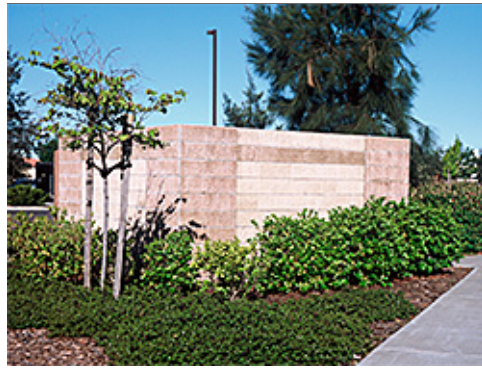

Trees, Shrubs and Groundcover



Colorful Ornamental Species

1. Provide complimentary accent landscaping at monuments and static displays.
2. At Facility Group 1, provide landscaping adjacent to all freestanding signs without distracting from the written communication.
3. Provide landscape screening of utility elements adjacent to Facility Group 1.
4. Providing landscaping as visual screening is preferred to the construction of walls and fences; berming and mounding may supplement landscape screening.

#### **C06.1.11. Other**

Applicable  N/A Large graphics do not apply

Applicable  N/A Small graphics do not apply

#### **C07. SITE FURNISHINGS**

Comply with AF Corporate Standards for Site Development:  
<http://afcs.wbdg.org/site-development/index.html>

Comply with AF Corporate Standards for Site Furnishings:  
<http://afcs.wbdg.org/site-development/site-furnishings/index.html>

## C07.1. Furnishings and Elements

Applicable  N/A Select number of graphics / images (large: 800 px x 440 px) to insert 1

Image Tool 800 x 440

Applicable  N/A Small graphics do not apply



Coordinated Site Furnishings at Paved Plaza

1. Provide a coordinated consistent inventory of site furnishings to positively contribute to the visual environment, image, and identity of the base; ensure durability, low maintenance, reduced visual clutter, and compatibility with the adjacent architecture.
2. Remove poorly located or redundant litter / ash receptacles, newspaper and bicycle racks, telephone booths, vending machines, walls and fences to reduce visual clutter and to lessen the requirements for maintenance.
3. Group 1 and 2 site furnishing shall be concrete, recycled plastic or metal with factory applied earth tone colors. Accent colors may be appropriate in select areas as approved by 60 CES/CEN. Groups 3 and 4 site furnishings shall be constructed of concrete or coated metal with factory applied earth tone colors. Generally match the site furniture of adjacent facilities and the facility district.
4. Install needed outdoor seating (benches and low walls) in public gathering spaces near main and secondary building entrances. Low walls shall match facility architecture.
5. Benches in Groups 1, 2 and 3 shall be concrete, recycled plastic or metal with factory applied earth tone colors. Accent colors may be appropriate in select areas as approved by 60 CES/CEN. Groups 3, 4 and park site furnishings shall be constructed of concrete or coated metal with factory applied earth tone colors. Generally match the site furniture of adjacent facilities and the facility districts. Place seating along walkways, building entries, courtyards and plazas. Place benches on paved areas.
6. Integrate functional bicycle racks with the design of the building's main entrance grounds in Facility Groups 1 and 2 while meeting AT/FP requirements. Combine areas for densely sited buildings. Incorporate bike racks into hardscape design within 200 yards of building entrance but no closer than 82 feet (25m) to any occupied building or portion thereof.

Screen large bicycle parking areas with landscaping or screen walls. A ribbon shaped metal rack is preferred for all high visibility sites.

7. Use bollards to protect buildings, equipment, and people from vehicle impact and to restrict access. Use a six inch diameter, steel round top bollard as the standard. For force protection use 8-inch diameter, concrete filled, steel pipe. Paint Base Brown and apply three inch wide yellow and black striped reflective tape around the bollard six inches from the top. Feature/accent bollards should be precast concrete and match beige stucco. Bollards at the flightline and industrial areas shall be painted safety yellow with reflective beads for high visibility especially at night.
8. Place surface mounted or portable litter and ash receptacles at building entrances, pathways, outdoor seating, and picnic areas. Locate these to be functional, yet visually unobtrusive. Minimize the use of freestanding planters. When used, locate planters in conjunction with other exterior elements.
9. Generally limit picnic tables, barbeque grills and drinking fountains to lodging, dormitories, housing areas, parks and recreation areas following IFS. BCE will make a selection from the following materials dependent on the location: concrete; factory finished, recycled plastic picnic tables with metal frames; or vinyl-coated steel tables and seating with an open mesh design. Provide mid-morning to late-afternoon shade for all picnic tables. Ensure tables are accessible (ADA/ABAA compliant). Placement and design of built-in grills must be approved by the ACRB. Use materials that complement adjacent facilities.
10. The Installation Flagpole location shall comply with the guidance for the display of flags in AFI 34-1201. Each Air Force installation is authorized to fly one United States Flag, normally in front of the installation headquarters. Waivers for non-authorized locations must be submitted in accordance with AFI 33-360 and approved waivers (AF Form 679) must be maintained by the installation protocol office.
11. Refer to the Overview Section "Facility Hierarchy" topic of this AFCFS for guidelines regarding ancillary structures such as pavilions and shade shelters.
12. Bus shelters shall be provided only where there is a documented need and when approved on a case basis. Generally emulate the designs of adjacent facilities and outdoor furniture using dark bronze aluminum powder coat anodized finish.
13. Monuments and static displays shall be limited. New elements must be fully vetted through the base's approval process and designed following IFS.
14. When visual screening is necessary, consider landscaping as the first option. Use landscaping to soften walls and fences and to screen dumpsters. Ribbed is the standard texture for CMU screens or enclosures. Perforated metal screening with a factory applied finish may be used for appropriate locations. Ensure screens are high enough to conceal equipment, vending machines and utilities. Consider ATRP requirements.
15. For fencing, apply the standards for "Products, Materials and Color" in the following section. Limit those with the highest visual quality to Facility Group 1 where there is sustained maintenance. Define all levels of security and visual quality.
16. Do not use chain-link fencing at Group 1, 2 or 4 facilities; Limit the use of barbed-wire outriggers on chain-link fencing at industrial sites, unless required for additional security or protection of assets.
17. Wood fencing may be used in Facility Group 4 and in recreation areas following IFS for material and finish when there is sustained periodic maintenance.
18. Trash dumpster enclosures shall be constructed of split face or ribbed CMU for walls to match adjacent CMU in area. Height shall be 76" above finish grade. Walls shall have a rounded and integrally colored grout top matching block color. Color shall be beige for walls and brown accents. Locate dumpster enclosures to minimize visual impact. In high-visibility locations, provide factory finished metal gates to screen dumpsters. Concrete slab within the enclosure shall have positive drainage to exterior.
19. Limit the use of freestanding planters to areas with ongoing maintenance. Use planters that match litter and ash receptacles in design.



20. Provide kiosks only where there is a documented need for visual communication of posted messages. When used, match adjacent facilities in materials and detailing and consolidate kiosks with other site furnishings within 30 feet of major pedestrian paths. Limit kiosks to facility Groups 1 and 2 and parks.

21. Manufacturers listed below are only provided to establish a baseline of equivalency among all applicable manufacturers.

## C07.2. Site Furnishings Products, Materials and Color

**Note:** Apply the below base-wide standards for Site Furnishings (products, materials and color). Then refer to the Appendix and apply any additional requirements specifically related to the Facility District in which the project is located.

### C07.2.1. Barbeque Grills

Applicable  N/A

Number of base standards 2

Image Tool 250 x 188



Type: **Charcoal**

Applies to:  Group 1  Group 2  Group 3  Group 4  Other

Mfr: Most Dependable Fountains, Inc.

Color: Natural stainless steel

Finish: Mill

Model #: SS BBQ Grill

Other: Concrete foundation, coordinate with Base Architect

UFGS: N/A

Type: **Natural Gas**

Applies to:  Group 1  Group 2  Group 3  Group 4  Other

Mfr: BBQ Coach

Color: Natural stainless steel

Finish: Mill

Model #: 32" 4-Burner

Other: Built-in Concrete or masonry, coordinate with Base Architect

UFGS: N/A



## C07.2.2. Benches

Applicable  N/A

Number of base standards 2

Image Tool 250 x 188



Type: **Perforated Metal**

Applies to:  Group 1  Group 2  Group 3  Group 4  Other

Mfr: Belson

Color: Black

Finish: Powder Coat

Model #: Model 1H4CSS

Other: Horizontal Slot Pattern, Surface Mount

UFGS: N/A



Type: **Slatted Metal**

Applies to:  Group 1  Group 2  Group 3  Group 4  Other

Mfr: Belson

Color: Black

Finish: Powder Coat

Model #: CBPB-6SB-BK

Other: Optional ground mount

UFGS: N/A



### C07.2.3. Bike Racks

Applicable  N/A

Number of base standards 2

Image Tool 250 x 188

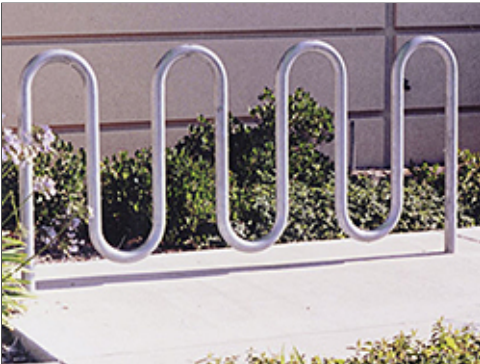

Type: **Style 1**

Applies to:  Group 1  Group 2  Group 3  Group 4  Other

Mfr: Brandir International Inc.

Color: Galvanized or Dark Bronze

Finish: Factory

Model #: The Ribbon Bike Rack, RB-07

Other: N/A

UFGS: N/A

Type: **Style 2**

Applies to:  Group 1  Group 2  Group 3  Group 4  Other

Mfr: Custom

Color: Dark Bronze

Finish: Powder Coat

Model #: U-Shaped In-Ground Mount

Other: Provide cast concrete slab or at grade pier to conceal mounting

UFGS: N/A

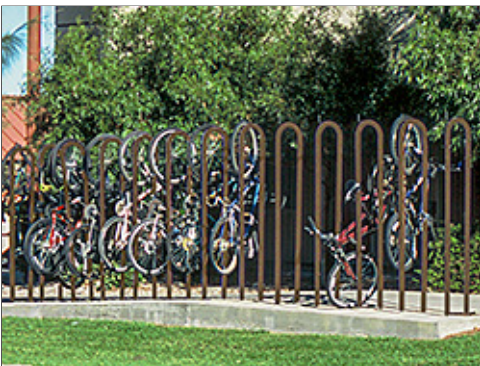

### C07.2.4. Bike Lockers

Applicable  N/A

## C07.2.5. Bollards

Applicable  N/A

Number of base standards 4

Image Tool 250 x 188



Type: **Lighted Square Flat Top**

Applies to:  Group 1  Group 2  Group 3  Group 4  Other

Mfr: Lithonia Lighting Products

Color: Dark Bronze

Finish: Anodized aluminum

Model #: KBS

Other: 3000K LED Lamp, 360° downlighting

UFGS: N/A



Type: **Lighted Round Flat Top**

Applies to:  Group 1  Group 2  Group 3  Group 4  Other

Mfr: Lithonia Lighting Products

Color: Dark Bronze

Finish: Anodized aluminum

Model #: KBD or KBR

Other: Flared cone, 3000K LED Lamp

UFGS: N/A





Type: **Building Protection, Concrete**

Applies to:  Group 1  Group 2  Group 3  Group 4  Other

Mfr: Local TBD

Color: Natural Concrete, Optional Black Fixture

Finish: Natural Concrete, Factory Powder Coated Metal

Model #: 8" Round

Other: Bollards may be tapered to match adjacent facilities

UFGS: N/A

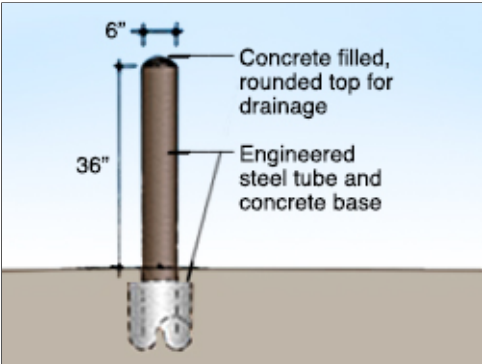

Type: **Building Protection, Steel**

Applies to:  Group 1  Group 2  Group 3  Group 4  Other

Mfr: (Bollard Cover) Reliance Foundry

Color: Brown cover may be field painted dark bronze

Finish: Factory

Model #: 6" Steel pipe, concrete filled, Cover: R-7173

Other: A 1" (25.4 mm) rigid conduit and box with shroud may be provided at top of bollard with a receiver/key switch application

UFGS: N/A

### C07.2.6. Bus Shelters

Applicable  N/A

Number of base standards 1

Image Tool 250 x 188

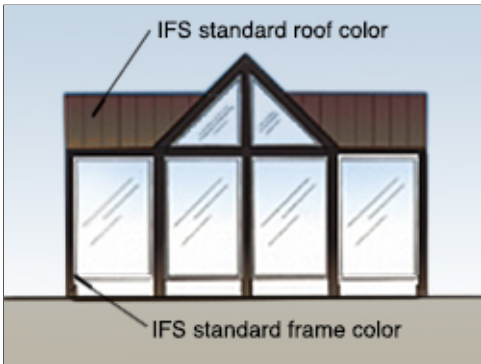

Type: **1**

Applies to:  Group 1  Group 2  Group 3  Group 4  Other

Mfr: Custom

Color: Dark Bronze

Finish: Powder coated

Model #: Gabled roof

Other: Provide concrete slab and 2 pre-manufactured aluminum benches

UFGS: N/A

### C07.2.7. Drinking Fountains

Applicable  N/A

Number of base standards 1

Image Tool 250 x 188



Type: **Pedestal**

Applies to:  Group 1  Group 2  Group 3  Group 4  Other

Mfr: Most Dependable Fountains, Inc.

Color: Natural

Finish: Stainless Steel

Model #: MDF 440 SMSS

Other: Accessible

UFGS: N/A

### C07.2.8. Dumpster Enclosures / Gates

Applicable  N/A

Number of base standards 1

Image Tool 250 x 188



Type: **CMU and Steel**

Applies to:  Group 1  Group 2  Group 3  Group 4  Other

Mfr: Custom

Color: Tan and buff CMU blend, dark bronze doors

Finish: Slit Face and Ground Face CMU, powder coated doors

Model #: Match adjacent building

Other: Steel gates and hardware, dark bronze, dumpsters shall be painted dark brown

UFGS: Section 04 20 00 Unit Masonry

### C07.2.9. Fencing

Applicable  N/A

Number of base standards 7

Image Tool 250 x 188

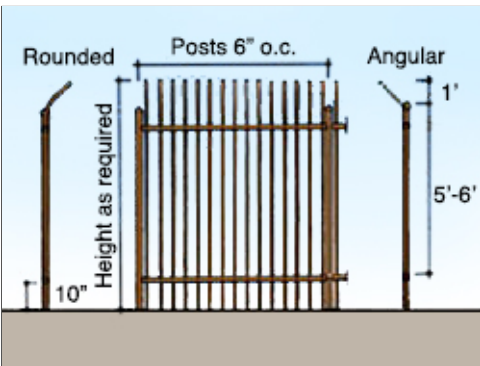

Type: **Style A Barrier: High Security, High Visibility**

Applies to:  Group 1  Group 2  Group 3  Group 4  Other

Mfr: Custom

Color: Dark bronze

Finish: Powder coated

Model #: Steel posts, rails and pickets (vertical, bent outward at top)

Other: Split Face or ground face beige CMU piers may be used. CMU piers may receive a stucco finish matching the color of the adjacent building.

UFGS: Section 05 50 13 Miscellaneous Metal Fabrications



Type: **Style B Barrier: High Security, Medium Visibility**

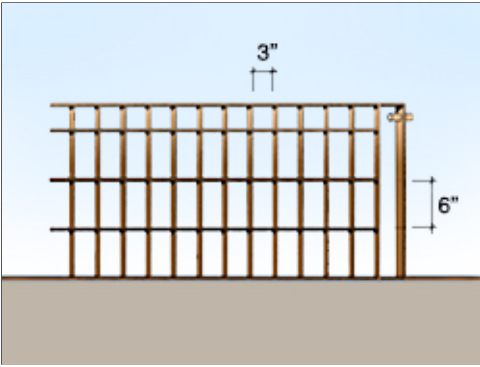

Applies to:  Group 1  Group 2  Group 3  Group 4  Other

Mfr: Custom

Color: Dark brown

Finish: Powder coat

Model #: Steel grid: flat bar stock verticals, round rod horizontals

Other: Steel posts, horizontal bars, braces, and accessories, in heights, lengths, and gauges as required; Close all ends of tubing

UFGS: Section 05 50 13 Miscellaneous Metal Fabrications

Type: **Style C Barrier: High Security, Low Visibility**

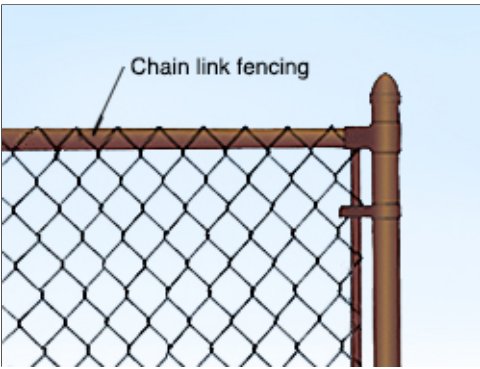

Applies to:  Group 1  Group 2  Group 3  Group 4  Other

Mfr: Custom

Color: Black or dark bronze

Finish: Powder coated galvanized steel

Model #: Chain link, steel posts and rails, gates and accessories

Other: Posts, rails, and pickets in heights, lengths and gauges as required, (see Appendix for Facility Districts requirements). Provide matching gates where required.

UFGS: Section 32 31 13 Chain Link Fences and Gates

Type: **Style D Barrier: Low security, High visibility**

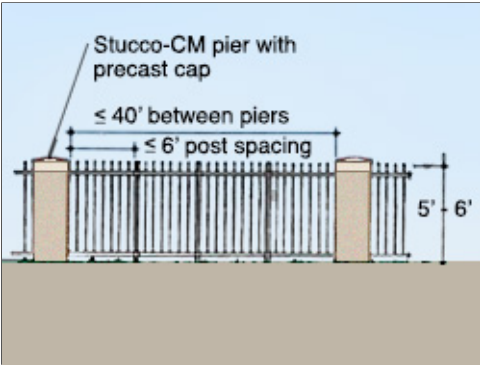

Applies to:  Group 1  Group 2  Group 3  Group 4  Other

Mfr: Custom

Color: Beige Stucco, dark bronze fencing

Finish: Stucco or Split Face CMU, powder coated metal

Model #: Stucco-CMU Piers with steel posts, rails and pickets

Other: CMU: 2'x2' (Height as required, equally spaced 12' to 40'), Steel posts: 4"x4" (equally spaced), Rails: 2"x2", Pickets: 1"x1" (6"o.c.); close all ends of tubing

UFGS: Section 04 20 00 Unit Masonry, Section 05 50 13 Misc. Metal

Type: **Style E Barrier: Low security, High visibility**

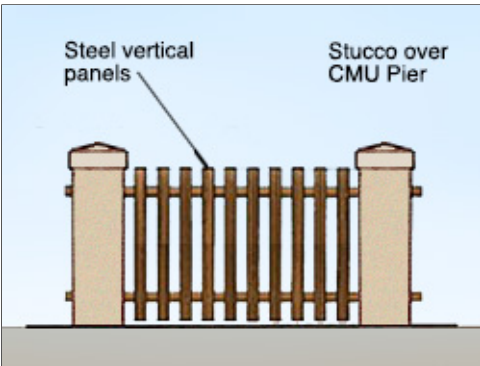

Applies to:  Group 1  Group 2  Group 3  Group 4  Other

Mfr: Custom

Color: Beige Stucco, dark bronze fencing

Finish: Stucco or Split Face CMU, powder coated metal

Model #: Stucco-CMU Piers with steel posts, rails and alternating panels

Other: CMU: 2'x2' (Height as required, equally spaced 8' to 40'), Steel posts: 4"x4" (equally spaced), Rails: 1-1/4"x1-1/2", vertical steel panels spaced alternately on each side of the rails; matching gates; close all ends

UFGS: Section 04 20 00 Unit Masonry, Section 05 50 13 Misc. Metal



Type: **Style F Barrier: Very low security, high visibility**

---

Applies to:  Group 1  Group 2  Group 3  Group 4  Other

Mfr: Custom

---

Color: Integral mixed Davis Colors: dark warm gray

---

Finish: Factory

---

Model #: Post and rail

---

Other: Concrete 3-rail, wood-grain textured (4,000 psi at 28 days); Posts: 39" height, 8' spacing, set 30" deep below grade with footing, typical

---

UFGS: SECTION 03 33 00 Cast-In-Place Architectural Concrete

---

Type: **Style G Barrier (Alternate): Very low security, high visibility**

---

Applies to:  Group 1  Group 2  Group 3  Group 4  Other

Mfr: James Hardie Building Products, Inc.

---

Color: Off white and Earth tones

---

Finish: Factory

---

Model #: Post and rail with vertical boards

---

Other: Posts: Height as required, 8' max. spacing; apply boards to outside face.

---

UFGS: Not Available (SECTION 074646 Fiber Cement Siding)

---





### C07.2.10. Flagpoles

Applicable  N/A

Number of base standards 1

Image Tool 250 x 188



Type: 1

Applies to:  Group 1  Group 2  Group 3  Group 4  Other

Mfr: Eder Flag

Color: Natural aluminum

Finish: Satin Lustre

Model #: ECL30 IH, Internal Halyard

Other: 5" Butt Dia. 33' H (30' Exposed)

UFGS: N/A

### C07.2.11. Lighting – Landscape / Accent

Please refer to the Lighting section.

### C07.2.12. Litter and Ash Receptacles

Applicable  N/A

Number of base standards 2

Image Tool 250 x 188



Type: Style 1: Concrete Trash Receptacle

Applies to:  Group 1  Group 2  Group 3  Group 4  Other

Mfr: Belson

Color: White with Acid Wash Stain (Light Beige)

Finish: Light Texture

Model #: TF1151

Other: Aluminum Lid, include optional black plastic internal liner

UFGS: N/A



Type: **Style 2: Metal**

Applies to:  Group 1  Group 2  Group 3  Group 4  Other

Mfr: Wabash Valley

Color: Black or as approved

Finish: Powder Coated Steel

Model #: Urbanscape - "J" Style 32 Gallon Receptacle with Liner

Other: Flat Top

UFGS: N/A

### C07.2.13. Picnic Tables

Applicable  N/A

Number of base standards 3

Image Tool 250 x 188



Type: **Contemporary Aluminum Dining Table and Chairs**

Applies to:  Group 1  Group 2  Group 3  Group 4  Other

Mfr: Moda

Color: Natural Aluminum

Finish: Standard Finish (Smooth)

Model #: 5113-LHSU

Other: Stacking Chairs

UFGS: N/A



Type: **Metal, Vinyl Coated**

Applies to:  Group 1  Group 2  Group 3  Group 4  Other

Mfr: Wabash Valley

Color: Brown or as approved

Finish: Factory vinyl coated

Model #: Signature Series, 46" Square Pedestal Tables with 4 Seats

Other: Perforated Pattern, In-ground mount

UFGS: N/A



Type: **Composite Recycled Content**

Applies to:  Group 1  Group 2  Group 3  Group 4  Other

Mfr: TimberForm

Color: Black Frame, Wood Tone Top and Seats

Finish: Powder coated metal, factory recycled slabs

Model #: 2167

Other: Accessible Picnic Table with Seats (Recycled Plastic Slats)

UFGS: N/A



### C07.2.14. Planters

Applicable  N/A

Number of base standards 1

Image Tool 250 x 188

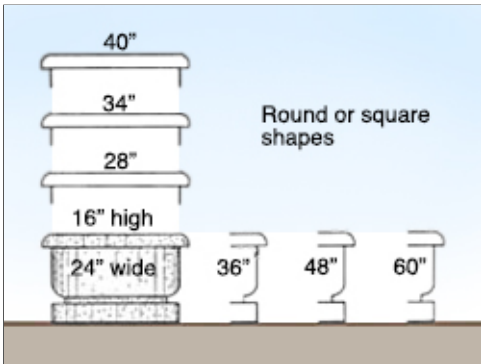

Type: **Precast concrete**

Applies to:  Group 1  Group 2  Group 3  Group 4  Other

Mfr: Materials, Inc.

Color: Weatherstone Gray

Finish: Smooth

Model #: Santa Fe

Other: N/A

UFGS: N/A

### C07.2.15. Play Equipment

Applicable  N/A

Number of base standards 1

Image Tool 250 x 188



Type: **Steel**

Applies to:  Group 1  Group 2  Group 3  Group 4  Other

Mfr: Little Tikes Commercial

Color: Varies

Finish: Powdercoated Steel

Model #: N-R-G Freestyle

Other: Coordinate with Base Architect

UFGS: N/A

## C07.2.16. Screen Walls

Applicable  N/A

Number of base standards 2

Image Tool 250 x 188



Type: **CMU Walls or CMU Piers with Steel Fencing**

Applies to:  Group 1  Group 2  Group 3  Group 4  Other

Mfr: Custom

Color: CMU beige blend walls or posts with dark brown fencing

Finish: Split Faced CMU, powder coated metal

Model #: CMU Walls or piers with steel posts, rails and alternating panels

Other: CMU Pier: 2'x2' (Height as required, equally spaced 8' to 40'), Steel posts: 4"x4" (equally spaced), Rails: 1-1/4"x1-1/2", vertical steel panels spaced alternately on each side of the rails; matching gates; close all ends

UFGS: Section 04 20 00 Unit Masonry, Section 05 50 13 Misc. Metal

Type: **Perforated Steel Sheeting with Steel Framing**

Applies to:  Group 1  Group 2  Group 3  Group 4  Other

Mfr: Custom

Color: Black or Dark Bronze

Finish: Powder Coated

Model #: Steel Tube Framing

Other: Provide matching gates as required

UFGS: Section 05 50 13 Misc. Metal



### C07.2.17. Tree Grates

Applicable  N/A

Number of base standards 1

Image Tool 250 x 188



Type: **Cast Iron**

Applies to:  Group 1  Group 2  Group 3  Group 4  Other

Mfr: Neenah Enterprises, Inc.

Color: Natural cast iron

Finish: Cast

Model #: 2-Piece, round or square

Other: N/A

UFGS: N/A

### C07.2.18. Other

Applicable  N/A

## C08. EXTERIOR SIGNS

Comply with AF Corporate Standards for Site Development:

<http://afcs.wbdg.org/site-development/index.html>

Comply with AF Corporate Standards for Exterior Signs:

<http://afcs.wbdg.org/site-development/exterior-signs/index.html>



## C08.1. Colors and Types

Applicable  N/A Large graphics do not apply

Applicable  N/A Select number of graphics / images (small: 250 px x 188 px) to insert 3

Image Tool 250 x 188



Building Identification Sign



Building Number Sign



Monument Sign for Housing Area

1. Provide concise functional signs as a visually unifying element with consistent colors and types for all Installation and Gate Identification Signs; Building Identification Signs; Traffic Control Devices; Directional and Wayfinding Signs; and Informational and Motivational Signs.
2. Provide signs with the lowest overall life cycle costs considering initial cost, ongoing maintenance and lifespan while meeting quality standards. Follow IFS for specifications appropriate for the local climate to withstand weathering.
3. Reduce the number of signs, reduce visual clutter and provide only essential signs required for identification, directions, instructions, and customer service following UFC 3-120-01. Remove non-conforming signs during renovation projects.
4. Use clear concise terms for content consistent with UFC 3-120-01.
5. Display of emblems on building exterior walls or other permanent structures is prohibited by UFC.
6. Raised "standout" letters and numbers may be used for Group 1 with approval on a case basis.
7. Group 2 and 3 facilities shall have wall mounted facility signs with sizes and layouts following UFC 3-120-01. Signs are not permitted for Group 4 facilities.
8. Only one identification sign is permitted at each building entrance. Include a building address consistent with US Postal Service protocols following UFC 3-120-01.
9. Traffic Control Devices, which regulate vehicular traffic on the installation, shall conform to the standards in the Manual of Uniform Traffic Control Devices (MUTCD) published by the Federal Highway Administration. Coordinate street signs with this IFS.
10. Provide Directional and Wayfinding Signs and address both pedestrian and vehicular traffic following UFC 3-120-01 for size, layout and content.
11. Reserved parking signs should be kept to a minimum. When approved, provide post-mounted sign faces in base standard materials and colors. Consider "bracketing" a designated area with a single sign at each end.
12. Parking lot identification signs may be used to identify areas or rows within large lots.
13. Follow the guidelines and requirements in ABAAS and the MUTCD for accessible parking signs.
14. Follow UFC 3-120-01 for Informational and Motivational Signs for size, layout and content.

- 15. Symbols or pictographs (graphic expressions of actual objects) may be used to indicate service, mandatory / prohibitory, sports, and recreation when rapid communication is necessary.
- 16. Changeable Force Protection signage may be applied to glass doors at primary building entrances.
- 17. Refer to UFC 3-120-01 for prohibited signs, which include those with animated, blinking, chasing, flashing, or moving effects. Traffic regulation signage with hazard flashers (i.e. pedestrian crossings) are allowed. Other types of prohibited signs include rotating signs, windblown or inflated signs, neon signs and portable signs.

**C08.1.1. Materials and Color Specifications**

Applicable  N/A Large graphics do not apply

Applicable  N/A Small graphics do not apply

- 1. Exterior Regulatory Signs: Fabricate sign panels from 0.080 inch high grade aluminum alloy, laminated with a high intensity diamond prismatic grade vinyl. Text will be electro-cut reflective engineer grade vinyl or ink jet factory printed (if purchased). Sign posts shall be 2"x2" square hot dipped galvanized perforated steel post, preferably powder coated anodized bronze. Sign posts shall be set in an 18" long by 2.5" galvanized perforated breakaway sleeve set in at 12" x 24" concrete footing, with 3" of the sleeve above grade (2"x2" inside) with capped ends in a concrete base.
- 2. Fence mounted sign panels may be attached with exposed fasteners.
- 3. All signage shall follow Federal Highway Administration (FHWA) Manual on Uniform Traffic Control Devices (MUTCD) using standard colors. Refer to MUTCD color specifications, which provide cross-referenced Pantone Matching System (PMS) numbers.
  - a. Standard Blue
  - b. Standard Dark Bronze (also Federal Standard Color 30040)
  - c. Standard Red
  - d. Standard Black (non-reflective)
  - e. Standard White
  - f. Standard Brown

**Materials and Color Specifications**

Applicable  N/A Number of base standards 3



Type: **Typical Sign Fce**

Applies to:  Group 1  Group 2  Group 3  Group 4  Other

Mfr: Custom

Color: Medium bronze

Finish: Matte vinyl

Model #: Aluminum flat sheet

Other: Mount to square posts. Provide sizes following UFC.

UFGS: Section 05 50 13 Miscellaneous Metal Fabrications

Type: **Typical Sign Post**

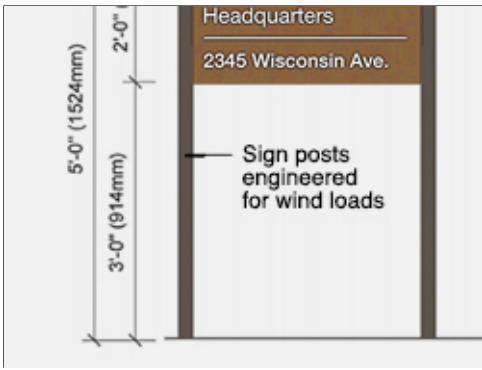

Applies to:  Group 1  Group 2  Group 3  Group 4  Other

Mfr: Custom

Color: Dark bronze, powder coat finish

Finish: Matte

Model #: Extruded aluminum with capped top ends

Other: Square posts and squared ends. Provide engineered sizes.

UFGS: Section 05 50 13 Miscellaneous Metal Fabrications

Type: **Typical Sign Base**

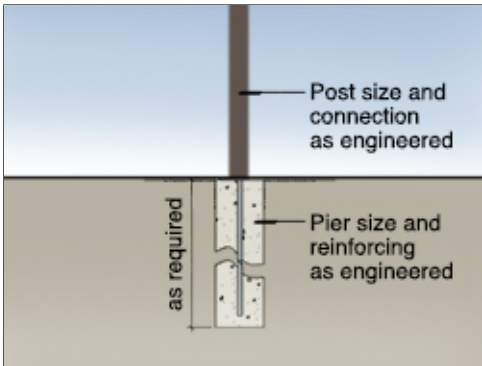

Applies to:  Group 1  Group 2  Group 3  Group 4  Other

Mfr: Custom

Color: Natural Gray

Finish: Sonotube-formed

Model #: 24" height x 12" diameter, as engineered.

Other: At grade with 3/4" chamfer. Provide engineered sizes.

UFGS: UFGS 03 30 00 Cast-in-place Concrete



### C08.1.2. Installation and Gate Identification Signs

Applicable  N/A

Number of base standards 1

Image Tool 250 x 188



Type: **Primary, Secondary and Tertiary (Uses per UFC)**

Applies to:  Group 1  Group 2  Group 3  Group 4  Other

Mfr: Custom

Color: Dark bronze, brushed aluminum, accents per UFC

Finish: Powder coat or vinyl sign face

Model #: Metal frame and panels, buff stone base

Other: White vinyl lettering. Provide dimensions per UFC. Secondary signs shall match primary sign's materials, but shall be smaller in size per UFC. Tertiary signs shall follow the UFC.

UFGS: Section 05 50 13 Miscellaneous Metal Fabrications

### C08.1.3. Building Identification Signs

Applicable  N/A

Number of base standards 5

Image Tool 250 x 188

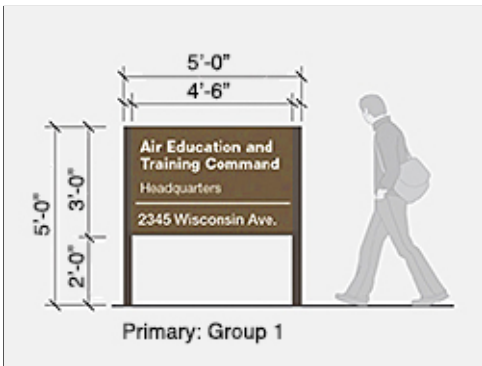

Type: **Freestanding Primary Sign (Sizes and Uses per UFC)**

Applies to:  Group 1  Group 2  Group 3  Group 4  Other

Mfr: Custom

Color: Medium brown face, dark bronze posts, white vinyl lettering

Finish: Powder coat or vinyl sign face

Model #: Aluminum sheet face, extruded aluminum posts

Other: Provide layout and sizes per UFC.

UFGS: Section 05 50 13 Miscellaneous Metal Fabrications

Type: **Freestanding Secondary Sign (Sizes and Uses per UFC)**

Applies to:  Group 1  Group 2  Group 3  Group 4  Other

Mfr: Custom

Color: Medium brown face, dark bronze posts, white vinyl lettering

Finish: Powder coat or vinyl sign face

Model #: Aluminum sheet face, extruded aluminum posts

Other: Provide layout and sizes per UFC.

UFGS: Section 05 50 13 Miscellaneous Metal Fabrications

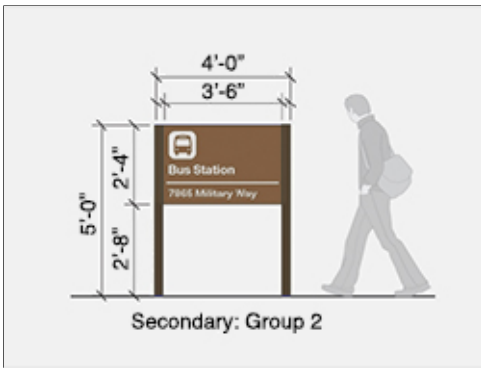

Secondary: Group 2

Type: **Freestanding Tertiary Sign (Sizes and Uses per UFC)**

Applies to:  Group 1  Group 2  Group 3  Group 4  Other

Mfr: Custom

Color: Medium brown face, dark bronze posts, white vinyl lettering

Finish: Powder coat or vinyl sign face

Model #: Aluminum sheet face, extruded aluminum posts

Other: Provide layout and sizes per UFC.

UFGS: Section 05 50 13 Miscellaneous Metal Fabrications

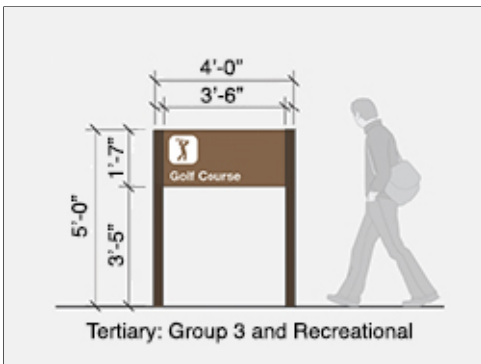

Tertiary: Group 3 and Recreational

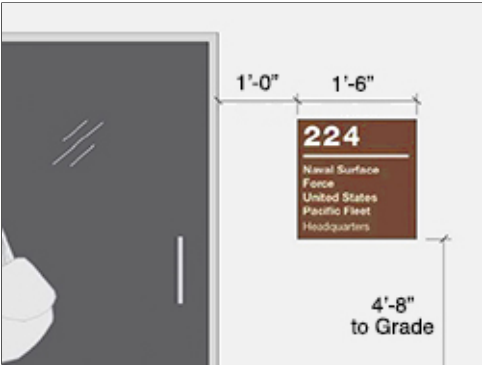

Type: **Wall Mounted**

Applies to:  Group 1  Group 2  Group 3  Group 4  Other

Mfr: Custom

Color: Medium brown, white lettering

Finish: Satin vinyl applied to aluminum sheet

Model #: Aluminum sheet with vinyl face and vinyl lettering

Other: Provide layout and sizes following UFC.

UFGS: N/A



Type: **Glass Mounted**

Applies to:  Group 1  Group 2  Group 3  Group 4  Other

Mfr: Custom

Color: White vinyl lettering

Finish: Matte vinyl

Model #: Machine-cut sheet vinyl

Other: Apply vinyl lettering to glass. Provide sizes following UFC.

UFGS: N/A



### C08.1.4. Traffic Control Devices (Street Signs)

Applicable  N/A

Number of base standards 1

Image Tool 250 x 188



Type: **Street Signs**

Applies to:  Group 1  Group 2  Group 3  Group 4  Other

Mfr: Custom

Color: White reflective lettering on a Standard Brown background

Finish: Powder coat or vinyl sign face

Model #: Aluminum sign face, control arm or pole mounted

Other: Mount 7' above grade minimum, pictographs and logos are prohibited on street name signs per UFC.

UFGS: Section 05 50 13 Miscellaneous Metal Fabrications

### C08.1.5. Directional and Wayfinding Signs

Applicable  N/A

Number of base standards 2

Image Tool 250 x 188

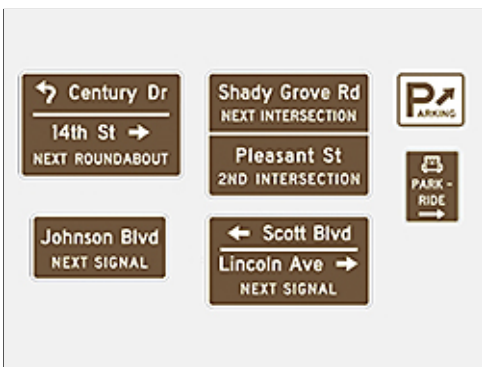

Type: **Vehicular**

Applies to:  Group 1  Group 2  Group 3  Group 4  Other

Mfr: Custom

Color: Medium brown face, dark bronze posts, white reflective lettering

Finish: Powder coat or vinyl sign face

Model #: Aluminum sheet face, extruded aluminum posts

Other: Conform to the requirements of the MUTCD and its DoD Supplement. Provide types and sizes where required by UFC.

UFGS: Section 05 50 13 Miscellaneous Metal Fabrications

Type: **Pedestrian**

Applies to:  Group 1  Group 2  Group 3  Group 4  Other

Mfr: Custom

Color: Medium brown face, dark bronze posts

Finish: Powder coat or vinyl sign face

Model #: Aluminum sheet face, extruded aluminum posts

Other: White vinyl lettering. Provide types and sizes where required by UFC.

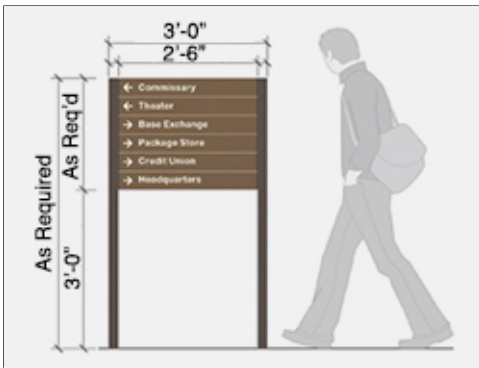

UFGS: Section 05 50 13 Miscellaneous Metal Fabrications

### C08.1.6. Informational Signs

Applicable  N/A Large graphics do not apply

Applicable  N/A Small graphics do not apply

1. Minimize informational signs such as static display signs, hours of operation, and project signs to reduce visual clutter.
2. Static display signs shall be designed suitable to the display. Solid cast metal signage is preferred with a suitable base, quality of finish suitable to the location..
3. Hours of operation signs shall have a level of quality equivalent to the Facility Group number.
4. Temporary / Project Signage shall be judiciously placed to avoid visual clutter. Contractor shall coordinate location of these signs with CE prior to installation.

### C08.1.7. Motivational Signage

Applicable  N/A Large graphics do not apply

Applicable  N/A Small graphics do not apply

1. Provide professionally produced motivational signs as important elements of campaigns to boost morale, improve safety, aid in recruiting, and accomplish other motivational objectives. Consolidate this signage to reduce visual clutter.
2. Motivational signs shall be limited to an electronic "marquee" type changeable sign near each gate. Temporary signs are not permitted. Motivational information may also be posted in a small, printed format on kiosks in specified, high pedestrian use areas. Refer to kiosks under Site Furnishings.
3. Follow UFC 3-120-01 for color and layout. Note that animated, blinking, chasing, flashing, or moving effects are prohibited by the UFC.
4. Mount marquee signs on reinforced concrete bases with a natural warm gray color.

### C08.1.8. Parking Lot Signs

Applicable  N/A

1. Follow guidelines and requirements in ABAAS and the MUTCD for accessible parking signage.
2. Limit number of parking signs by bracketing multiple reserved parking spaces when there are four or more contiguous reserved spaces.

### C08.1.9. Regulatory Signs

Applicable  N/A

1. Regulatory signage, which restricts, warns and advises, shall be limited to those mandated under Highway/Traffic, Government Warning, and/or Parking Regulation. Follow UFC 3-120-01 and its industry references for color and layout.
2. Provide a comprehensive, systematic approach to regulatory signage to avoid clutter and confusion from "over signage."
3. Maintain base warning signs for safety and security at the base perimeter and at specific secure areas. Use these to notify visitors of restrictions governing conduct on the base, as well as other security procedures.

### C08.1.10. Other

Applicable  N/A

## C09. LIGHTING

Comply with AF Corporate Standards for Site Development:

<http://afcs.wbdg.org/site-development/index.html>

Comply with AF Corporate Standards for Lighting:

<http://afcs.wbdg.org/site-development/lighting/index.html>

### C09.1. Fixtures and Lamping

Applicable  N/A Large graphics do not apply

Applicable  N/A Select number of graphics / images (small: 250 px x 188 px) to insert 3

Image Tool 250 x 188



Wall Mounted Lighting



Windows as a Focal Point



Entrance Lighting



1. Provide, coordinate and efficiently install street, parking lot, sidewalk and facility lighting with appropriate luminaires, lamping, placement and spacing following UFC 3-530-01 and Installation Facilities Standards (IFS); ensure the level of quality is consistent with the adjacent facility group number. Pole-mounted, wall-mounted and bollard fixtures are permitted.
2. Integrate controls to automatically reduce lighting power during periods of non-activity; automatically turn off power when sufficient daylight is available.
3. Ensure continuity and consistency of lighting elements. In new construction generally match post types, fixture types, styles, heights, sizes, materials, colors, and lamp types of adjacent facilities and the facility district.
4. Economically provide renewable-energy power sources such as solar photovoltaic when feasible.
5. Use appropriately designed or shielded luminaires to direct light downward to minimize light pollution and intrusion onto adjacent sites and to facilitate night training.
6. Calculate illuminant levels for all lighting applications following UFC 3-530-01 and ensure compliance with pre-curfew maximum brightness level requirements.
7. Sufficiently address environmental factors to prevent corrosion and weathering of fixtures, plinths and other components.
8. Wall mounted fixtures should respond to the architectural character of the facility.
9. Efficient accent lighting of architectural and landscape features may be provided for Group 1, lodging and historical applications. Accent lights in ground-mounted locations may be provided for static displays and signs when these do not conflict or cause hazards with overhead aircraft.
10. Comply with UFC 3-530-01 for light source technology and lamp types. High efficiency lamping such as LED is preferred for most applications.
11. Provide round tapered, square non-tapered, or round non-tapered aluminum poles and aluminum fixtures with square, rectangular or circular housings in colors and shapes to match adjacent facilities and the facility district.
12. Install lighted bollards only at Group 1 and high-traffic Group 2 facilities. Generally match materials, colors and shapes of adjacent facilities and the facility district.
13. Install natural warm gray color, smooth finished concrete bases for all poles in heights appropriate for the facility group and application. Generally Groups 1, 2 and 4 shall have at-grade bases. Group 3 shall have taller bases for added durability.
14. When parking lot lighting is necessary, provide an illuminated path to the building's main entrance. Pole bases should be contained within an internal landscape median or island.
15. Consistently install lighting for sidewalks, bikeways and trails to match adjacent facilities.
16. Landscape accent lighting may be used in public gathering spaces and in Group 1 facilities. Coordinate the design, luminaire selection, and placement with the location of trees, shrubs, and site furnishings.

## **C09.2. Light Fixture Types**

**Note:** *Apply the below base-wide standards for Light Fixtures (products, materials and color). Then refer to the Appendix and apply any additional requirements specifically related to the Facility District in which the project is located.*

## C09.2.1. Street Lighting

Applicable  N/A

Number of base standards 2

Image Tool 250 x 188

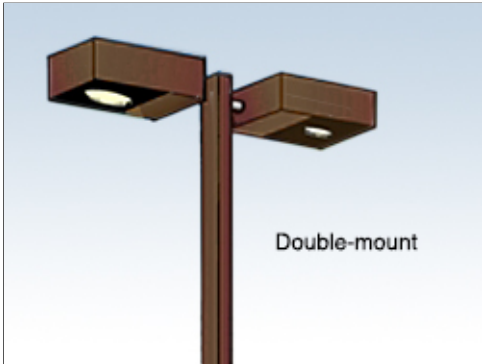

Type: **Style 1**

Applies to:  Group 1  Group 2  Group 3  Group 4  Other

Mfr: Hubbell, Kim Lighting

Color: Dark Bronze Anodized (or Clear Anodized as approved by BCE)

Finish: Factory

Model #: Rectilinear Cutoff, Single Arm or Dual Arm Mount

Other: Lamp: LED. Follow manufacturer's recommendations for fixture base.

UFGS: N/A

Type: **Style 2**

Applies to:  Group 1  Group 2  Group 3  Group 4  Other

Mfr: Hubbell, Kim Lighting

Color: Clear Anodized as approved by BCE

Finish: Factory

Model #: Round Cutoff, Single Arm or Dual Arm Mount

Other: Lamp: LED. Follow manufacturer's recommendations for fixture base.

UFGS: N/A



## C09.2.2. Parking Lot Lighting

Applicable  N/A

Number of base standards 2

Image Tool 250 x 188

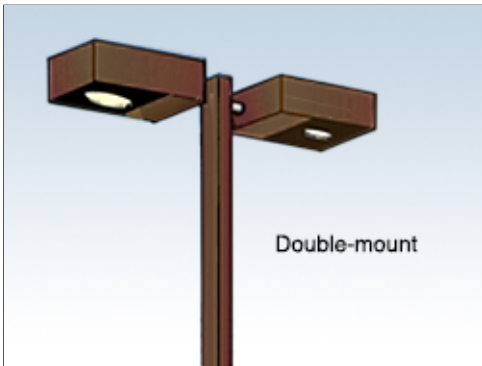

Type: **Parking Lot Style 1**

Applies to:  Group 1  Group 2  Group 3  Group 4  Other

Mfr: Hubbell, Kim Lighting

Color: Dark Bronze Anodized (or Clear Anodized as approved by BCE)

Finish: Factory

Model #: Rectilinear or Round Cutoff, Single Arm or Dual Arm Mount

Other: Lamp: LED. Follow manufacturer's recommendations for fixture base.

UFGS: N/A

Type: **Parking Lot Fixture Base**

Applies to:  Group 1  Group 2  Group 3  Group 4  Other

Mfr: Custom

Color: Natural gray

Finish: Trowel

Model #: Form-cast, round

Other: N/A

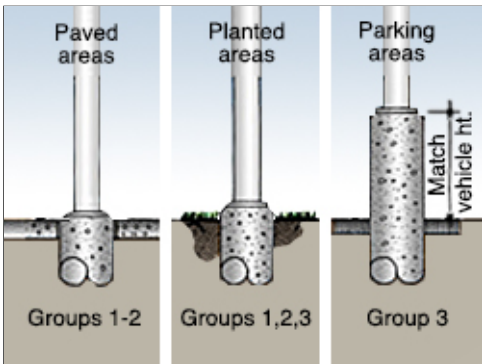

UFGS: Section 03 33 00 Cast-In-Place Architectural Concrete



### C09.2.3. Lighted Bollards

Applicable  N/A

Number of base standards 2

Image Tool 250 x 188



Type: **Lighted Square Flat Top**

Applies to:  Group 1  Group 2  Group 3  Group 4  Other

Mfr: Lithonia Lighting Products

Color: Dark Bronze

Finish: Anodized aluminum

Model #: KBS

Other: 3000K LED lamp, 360° downlighting

UFGS: N/A



Type: **Lighted Round Flat Top**

Applies to:  Group 1  Group 2  Group 3  Group 4  Other

Mfr: Lithonia Lighting Products

Color: Dark Bronze

Finish: Anodized aluminum

Model #: KBD or KBR

Other: Flared cone, 3000K LED lamp

UFGS: N/A

### C09.2.4. Sidewalk Lighting

Applicable  N/A      Number of base standards 1

Image Tool 250 x 188

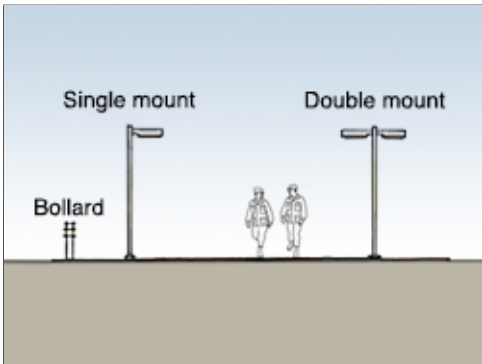

Type: **Rectilinear Cutoff**

Applies to:  Group 1  Group 2  Group 3  Group 4  Other

Mfr: Hubbell, Kim Lighting

Color: Dark Bronze Anodized (or Clear Anodized as approved by BCE)

Finish: Anodized aluminum

Model #: Rectilinear Cutoff, Single Arm or Dual Arm Mount

Other: Lamp: LED. Follow manufacturer's recommendations for fixture base.

UFGS: N/A

### C09.2.5. Walls / Stairs Lighting

Applicable  N/A      Number of base standards 1

Image Tool 250 x 188



Type: **Style 1**

Applies to:  Group 1  Group 2  Group 3  Group 4  Other

Mfr: Vista Lighting

Color: Dark bronze anodized

Finish: Smooth

Model #: Aluminum Step and Wall Lights, 5230 round louvered

Other: Lamp: LED

UFGS: N/A

### C09.2.6. Other

Applicable  N/A

## D. FACILITIES EXTERIORS

Comply with Air Force Corporate Standards for Facilities Exteriors:

<http://afcs.wbdg.org/facilities-exteriors/index.html>

Applicable  N/A Select number of graphics / images (large: 800 px x 440 px) to insert 1

Image Tool 800 x 440

Applicable  N/A Select number of graphics / images (small: 250 px x 188 px) to insert 3

Image Tool 250 x 188



Tower and Flightline Facilities

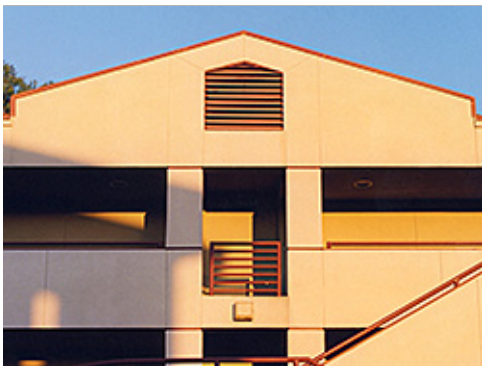

Dormitory



Hangar



Fire Station

### D01. SUPPORTING THE MISSION

Comply with AF Corporate Standards for Supporting the Mission:

<http://afcs.wbdg.org/facilities-exteriors/supporting-the-mission/index.html>

### D02. SUSTAINABILITY

Comply with Air Force Corporate Standards for Sustainability:

<http://afcs.wbdg.org/facilities-exteriors/supporting-the-mission/index.html>



### D03. ARCHITECTURAL FEATURES

Comply with AF Corporate Standards for Facilities Exteriors:

<http://afcs.wbdg.org/facilities-exterior/index.html>

Comply with AF Corporate Standards for Architectural Features:

<http://afcs.wbdg.org/facilities-exterior/architectural-features/index.html>

*Insert 3 photos for each facility group.*

Image Tool 250 x 188

Group 1



Group 2



Group 3



Group 4



### **D03.1. Orientation, Massing and Scale**

1. Orient new buildings to maximize energy efficiency, passive solar and daylighting potential of the building; narrow buildings oriented along an east-west axis are preferred to minimize heat gain in the summer months and maximize heat gain in the winter months resulting in less overall energy usage.
2. Provide orthogonal geometry for principal building form; angular geometry may be used sparingly for Group 1 and used only for emphasis at specific areas such as building entrances and stairwells.
3. Maintain a human scale and reduce the visual scale of large buildings with sub-massing related to interior functional operations; create consistent form and scale in adjacent buildings with compatible profiles or silhouettes.
4. Building heights shall not be limited; however, building heights over 2 stories shall be considered on a case basis.
5. Combine functions where practical to avoid a proliferation of small, independent structures.
6. Use and coordinate shading devices with orientation and for function.

### **D03.2. Architectural Character**

1. Develop architectural features, materials and detailing appropriate for the Facility Group designation. Refer to Building Entrances, Wall Systems and Roof Systems.
2. Respond to the local climate and regional influences with environmentally functional architectural features.
3. For new facilities design generally maintain consistency and visual unity in the character of the adjacent buildings through compatible architectural features: repeated use of similar forms such as roofs, and through recurring elements such as doors, windows, materials and colors.
4. Designers are encouraged to explore themes related to the history of the Air Force, the Air Mobility Command, the 60th Air Mobility Wing, and tenant units, and find elements that would be appropriate for the specific facility design. Such thematic material may include historic flags, symbols, emblems, and mottoes. These thematic elements should be incorporated where appropriate for highly visible facilities along the main thoroughfare and for public facilities.
5. All facilities shall express sustainability through their orientation, massing, shape, form, materials, and detailing. Provide louvers, fins and other shading devices to control heat gain and glare and to and improve energy efficiency.
6. Strive for economical construction without compromising a high-quality, professional appearance.

### **D03.3. Details and Color**

1. Provide a palette of earth-tone colors related to the native landscape in brick, block, stucco and powder-coated metals. Refer to wall systems for detailed material listings.
2. Relate the level of architectural detailing to the Facility Group number.
3. Use only integrally colored materials as the predominant exterior building material; do not use materials that require field painting and ongoing maintenance.
4. Provide consistent and compatible colors for every exterior building feature, including walls, roofs, doors, windows, gutters, downspouts, utility and mechanical elements, and other visible elements.
5. Noncorrosive metals with factory applied color finishes are required.
6. Combine details and color with orientation, massing, scale and architectural character to maintain base compatibility.

#### **D03.3.1. Climate-based Data and Life-Cycle Cost-Effective Passive and Natural Design Strategies:**

- Climate dominated by mechanical cooling

- Climate dominated by mechanical heating
- Climate with similar mechanical cooling / heating needs
- Climate with minimal mechanical cooling / heating needs
  
- Climate with high humidity
- Climate with moderate humidity
- Climate with low humidity
  
- High Solar Insolation
- Moderate Solar Insolation
- Low Solar Insolation
  
- Soils with High Thermal Conductivity
- Soils with Average Thermal Conductivity
- Soils with Low Thermal Conductivity

Other: Consider the potential for flooding and corrosion

Other: Exterior corridors and hallways may be provided when integrated with shading and rain protection

*Facility:* Narrow buildings along E-W axis are preferred

*Wall:* Integral shading features and devices / interior masonry thermal mass walls (for cooling)

*Doors:* Recessed are preferred

*Windows:* Provide insulating glazing on north-facing windows / maximize shading for windows on south façades

*Roof:* High to medium albedo, moderate slope for all buildings except hangars / large industrial facilities

*Structure:* Do not expose ferrous metals. Provide factory finished non-ferrous metals or concrete

*MEP:* Ground-source following LCCA

*Other:* Internal thermal mass walls may be used for cooling following LCCA

*Other:*

**Note:** Apply the below base-wide standards for Architectural Features (products, materials and color). Then refer to the Appendix and apply any additional requirements specifically related to the Facility District in which the project is located.



### D03.3.2. Natural Ventilation System

Applicable  N/A

Number of base standards 1

Image Tool 250 x 188



Type: **Style 1 Aluminum Windows**

Applies to:  Group 1  Group 2  Group 3  Group 4  Other

Mfr: Kawneer (or equivalent)

Color: Dark Bronze (or clear anodized as approved by BCE)

Finish: Anodized

Model #: 2x4, slider or awning type

Other: Provide thermally broken frames.

UFGS: Section 08 41 13 Aluminum-Framed Entrances and Storefronts

### D03.3.3. Thermal Mass

Applicable  N/A

Number of base standards 1

Image Tool 250 x 188



Type: **Style 1 Interior Wall Material**

Applies to:  Group 1  Group 2  Group 3  Group 4  Other

Mfr: Custom, TBD

Color: Beige Plaster or CMU

Finish: Light texture

Model #: Stucco or coursed unit masonry

Other: Plaster is preferred. Concrete block may only be used in Group 3 when approved by the BCE.

UFGS: Section 09 24 23 Cement Stucco or Section 04 20 00 Unit Masonry

### D03.3.4. Thermal Shading

Applicable  N/A

Number of base standards 1

Image Tool 250 x 188



Type: **Style 1 Wall Devices**

Applies to:  Group 1  Group 2  Group 3  Group 4  Other

Mfr: Kawneer (or equivalent) or custom

Color: Dark bronze

Finish: Factory, to match frames

Model #: Louver

Other: Shading devices may be attached to frames or structure

UFGS: Section 08 41 13 Aluminum-Framed Entrances and Storefronts

### D03.3.5. Renewable Heating/Cooling

Applicable  N/A

Number of base standards 1

Image Tool 250 x 188

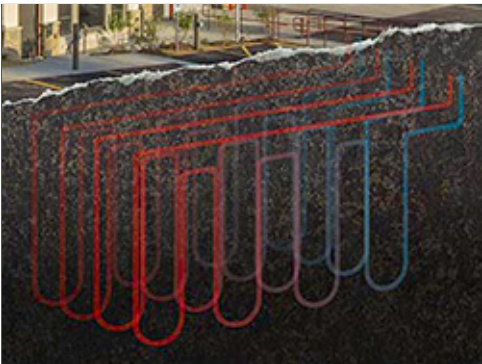

Type: **Style 1 Geothermal (Ground Source)**

Applies to:  Group 1  Group 2  Group 3  Group 4  Other

Mfr: Climate Master

Color: N/A

Finish: N/A

Model #: N/A

Other: Vertical ground loop well field

UFGS: Section 23 81 47 Water-Loop and Ground-Loop Heat Pump Systems

### D03.3.6. Solar Photovoltaic System

Applicable  N/A

Number of base standards 1

Image Tool 250 x 188



Type: **Roof mounted, or ground array systems**

Applies to:  Group 1  Group 2  Group 3  Group 4  Other

Mfr: TBD

Color: Factory

Finish: Factory

Model #: Flat plate collector

Other: A life-cycle cost analysis is required to determine applicability and benefit.

UFGS: 26 31 00 Solar Photovoltaic (PV) Components

### D03.3.7. Solar Thermal System

Applicable  N/A

Number of base standards 1

Image Tool 250 x 188



Type: **Loop feed, ground or roof mount**

Applies to:  Group 1  Group 2  Group 3  Group 4  Other

Mfr: TBD

Color: Factory

Finish: Factory

Model #: Flat plate collector

Other: A life-cycle cost analysis is required to determine applicability and benefit.

UFGS: 48 14 13.00 20 Solar Liquid Flat Plate and Evacuated Tube



## D04. BUILDING ENTRANCES

Comply with AF Corporate Standards for Facilities Exteriors:

<http://afcs.wbdg.org/facilities-exterior/index.html>

Comply with AF Corporate Standards for Building Entrances:

<http://afcs.wbdg.org/facilities-exterior/building-entrances/index.html>

*Insert 3 photos for each facility group.*

Image Tool 250 x 188

Group 1



Group 2



Group 3



Group 4



#### **D04.1. Primary Entrances**

1. Emphasize the primary entrance in the overall building design with a projecting or recessed covering for weather protection following Installation Facilities Standards (IFS) for Facility Group designations. Projected entrance features with gabled or hipped roof forms are preferred.
2. Provide vestibules and weather protected transition spaces at entries in Groups 1, 2 and 3 unless used infrequently or serving unconditioned space following ASHRAE 90.1.
3. Fully integrate all elements including the design of handicap ramps in the overall design of the primary entrance in an organized uncluttered appearance.
4. Install paved transitional spaces sized for the building function and occupancy.
5. Install appropriate lighting and site furniture following AT/FP and IFS. Locate newspaper, vending machines, and similar elements out of view to avoid visual clutter.
6. Address wind screening with walls, landscaping, and the configuration of the entrances.
7. Provide porte cocheres or covered drop-offs when justified for lodging and medical facilities; do not use for prestige or architectural accents.
8. Arcade elements may be used as an extension of the building's entrance. Integrate arcades with the building's form, materials, and detailing.

#### **D04.2. Secondary Entrances**

1. Provide vestibules at entries in Groups 1, 2 and 3 unless used infrequently or serving unconditioned space following ASHRAE 90.1; use of stair towers as vestibules for multi-story buildings is encouraged when building and / or energy codes are satisfied.
2. Reflect the character of the primary entrance to a lesser extent with a smaller scale.
3. Include a recess or projection for weather protection and shading.
4. Integrate service and egress doors and loading areas with the building design by matching the materials and detailing and reflect the overall quality of the facility.
5. Incorporate egress structures such as stair towers into the facility design.
6. Canopies may be used for service and loading areas; weather protection beyond weatherstripping, door sweeps and drip edge flashing are not required at doors used only for discharge or life safety egress.
7. Develop building massing and orientation to minimize the appearance of service and loading areas; physically and visually separate these from primary entrances.
8. Loading areas must be organized, orderly and have an uncluttered appearance.



## D05. WALL SYSTEMS

Comply with AF Corporate Standards for Facilities Exteriors:

<http://afcs.wbdg.org/facilities-exteriors/index.html>

Comply with AF Corporate Standards for Doors and Windows:

<http://afcs.wbdg.org/facilities-exteriors/wall-systems/index.html>

Comply with AFCFS Recommended Materials:

<http://afcs.wbdg.org/facilities-exteriors/wall-systems/materials/index.html>

*Insert 3 photos for each facility group.*

Image Tool 250 x 188

Group 1



Group 2



Group 3



Group 4





## D05.1. Hierarchy of Materials

1. Group 1 facilities may have more refined detailing than Group 2 and Group 2 may have more definition than Group 3.
2. Groups 1, 2, 3 and 4 facilities may predominantly use stucco.
  - a. Use integral colored, sand finish, three coat cement-based stucco system.
  - b. Locate expansion and contraction joints behind downspouts or at transitions in the wall such as at pilasters or reveals.
  - c. Protect stucco from being damaged by lawn maintenance equipment.
  - d. Precast concrete and split face concrete masonry blocks at base of walls are acceptable.
3. Groups 1, 2 and 3 may use the following alternate wall materials:
  - a. Split face tan color concrete masonry unit (CMU)
  - b. Exterior Insulation Finish System (EIFS) is acceptable for wall surfaces four feet or higher above grade.
  - c. EIFS coated pre-insulated metal panels is an acceptable alternate in utilitarian and industrial facilities
  - d. Precast concrete and split face block at base of walls are acceptable
  - e. Use of EIFS at columns is discouraged and prohibited for use at pedestals of columns
  - f. Do not paint concrete block.
4. Other Materials permitted for use on Groups:
  - a. Limit the use of pre-finished metal wall panels to large industrial/flightline facilities and special applications only with ACRB approval.
  - b. Factory finish all exposed metals with a powder-coat application such as Kynar-500.
  - c. Joint sealants shall match the color of the darker adjacent surfaces. When adjacent surfaces are the same color, use a joint sealant in the same color.
  - d. Translucent panels such are an acceptable material for limited use in Group 2 or 3 building façades with ACRB approval. Use Kalwall Crystal panels with Bronze color finish on frames or equal product. Provide insulating panels and shading appropriate for the orientation and exposure and protect from direct solar gain.
5. Accents/Detailing
  - a. Detailing shall consider overall building height and proportion.
  - b. Use accents such as medallions, stucco joints, and projected bases to highlight entries and façades.
  - c. High-visibility facilities shall have greater emphasis on detailing and articulation.
  - d. Use detailing not subject to excessive weathering. Provide wall accents consistently throughout the base.
6. Wall Components
  - a. Incorporate placement of all mechanical, electrical, lighting, communication and other building components, including downspouts, into the overall architectural design.
  - b. Conceal all conduits, cables, piping and other utilitarian items.
  - c. All gas meters, alarms, vents, louvers, and electrical/communication boxes shall match the wall surface color on which the equipment is mounted.
  - d. Use high-performance building envelopes following UFC 1-200-02.
7. Refer to the Appendix for special requirements of Facility Districts.

## D05.2. Layout, Organization and Durability

1. Organize wall components including doors, windows, accents, shading devices, control joints, etc., to provide an ordered, professional appearance.
2. Integrate shading devices into the overall composition of the wall.
3. Integrate fixed shading devices as at all exterior glazing exposed to summer UV heat gain as a passive design measure to reduce energy use. Ensure adequate shading at west entrances. Deciduous trees may be used for shading.
4. Shading systems may be included as part of a manufacturer's window system or may be custom systems integrated into the wall.
5. Provide appropriate transitions between dissimilar materials to mitigate effects of thermal expansion and galvanic action.

- 6. Materials requiring regular maintenance are not permitted; do not use exposed structural steel or other materials that require painting.
- 7. Refer to C07.2.16. Screen Walls for materials and colors of freestanding walls.
- 8. Refer to D07. Roofs for downspouts.

**D05.3. Equipment, Vents and Devices**

- 1. Arrange all mechanical, electrical, fire alarm, lightning protection and other system components to create an orderly appearance that integrates with the wall system.
- 2. Do not expose conduits, cables, piping, lightning protection components, etc. on exterior walls; if unavoidable in renovations, finish these elements to match the adjacent wall surface.
- 3. Avoid visual clutter and where surface-mounted elements are required they shall match the wall color.

**D05.4 Wall Systems Materials**

**Facility Group 1** wall materials shall be as follows.

- Primary: Stucco
- Secondary: Concrete Masonry Unit
- Accent: EIFS

**Facility Group 2** wall materials shall be as follows.

- Primary: Stucco
- Secondary: Concrete Masonry Unit or EIFS
- Accent: Optional: EIFS

**Facility Group 3** wall materials shall be as follows.

- Primary: Concrete Masonry Unit
- Secondary: Stucco
- Accent: Optional: Metal

**Facility Group 4** wall materials shall be as follows.

- Primary: Stucco
- Secondary: EIFS
- Accent: Optional: EIFS

**Note:** Apply the below *base-wide standards* for Wall Systems (products, materials and color). Then refer to the Appendix and apply any additional requirements specifically related to the Facility District in which the project is located.

**D05.4.1. Flat Metal Panels**

- Applicable  N/A
- 

**D05.4.2. Brick Veneer**

- Applicable  N/A
- 

**D05.4.3. Architectural Precast**

- Applicable  N/A
-

#### D05.4.4. Stucco Over Sheathing

Applicable  N/A

Number of base standards 1

Image Tool 250 x 188



Type: **3-Coat Cement Stucco**

Applies to:  Group 1  Group 2  Group 3  Group 4  Other

Mfr: La Habra or El Rey

Model #: Trowel applied

Color: Light beige or tan

Finish: Sand

Other: Coordinate locations of control joints with base architect

UFGS: Section 09 24 23 Cement Stucco:

[http://www.wbdg.org/FFC/DOD/UFGS/UFGS\\_09\\_24\\_23.pdf](http://www.wbdg.org/FFC/DOD/UFGS/UFGS_09_24_23.pdf)

---

#### D05.4.5. Curtain Wall

Applicable  N/A

---

#### D05.4.6. Cast-In-Place Concrete

Applicable  N/A

---

#### D05.4.7. Tilt-Up Concrete

Applicable  N/A

---



### D05.4.8. Ribbed Metal Sheeting

Applicable  N/A      Number of base standards 1

Image Tool 250 x 188



Type: **Flush Seam**

Applies to:  Group 1  Group 2  Group 3  Group 4  Other

Mfr: Berridge

Model #: Flush Seam Panel

Color: Beige

Finish: Embossed Texture, factory finished

Other: 24 Gauge Steel

UFGS: Section 07 42 13 Metal Wall Panels:  
<http://www.wbdg.org/FFC/DOD/UFGS/UFGS 07 42 13.pdf>

### D05.4.9. EFIS

Applicable  N/A      Number of base standards 1

Image Tool 250 x 188



Type:

Applies to:  Group 1  Group 2  Group 3  Group 4  Other

Mfr:

Model #:

Color:

Finish:

Other:

UFGS: Section 07 24 00 Exterior Insulation and Finish Systems:  
<http://www.wbdg.org/FFC/DOD/UFGS/UFGS 07 24 00.pdf>

### D05.4.10. GRFC

Applicable  N/A

### D05.4.11. Concrete Block

Applicable  N/A

Number of base standards 1

Image Tool 250 x 188



Type: **Split-face Block**

Applies to:  Group 1  Group 2  Group 3  Group 4  Other

Mfr: Local TBD

Model #: 8x16 nominal size, running bond

Color: Medium tan

Finish: Heavy texture

Other: N/A

UFGS: Section 04 20 00 Unit Masonry:

<http://www.wbdg.org/FFC/DOD/UFGS/UFGS 04 20 00.pdf>

---

### D05.4.12. Fiber Cement Siding

Applicable  N/A

---

### D05.4.13. Other

Applicable  N/A

---

## D06. DOORS AND WINDOWS

Comply with AF Corporate Standards for Facilities Exteriors:

<http://afcs.wbdg.org/facilities-exteriors/index.html>

Comply with AF Corporate Standards for Doors and Windows:

<http://afcs.wbdg.org/facilities-exteriors/doors-and-windows/index.html>

Comply with AFCFS Recommended Materials:

<http://afcs.wbdg.org/facilities-exteriors/doors-and-windows/materials/index.html>

Insert 3 photos for each facility group.

Image Tool 250 x 188

Group 1



Group 2



Group 3



Group 4





## **D06.1. Types**

1. For exterior doors requiring glazing, use dark anodized bronze aluminum storefront systems with thermal-break construction. Dark anodized bronze aluminum windows and frames with thermal breaks are standard for Facility Groups 1-3; match the color of the door and frame. For repair projects involving original wood or metal materials that have been field painted, the color of new windows, doors and frames may match the existing ones. Hardware shall be of same color.
2. All secondary-use and service doors and frames shall be painted to match adjacent wall color.
3. Aluminum clad wood windows are preferred for Facility Group 4.
4. Standard-sized hinged doors are preferred. Use sliding, folding, overhead, sectional and other door configurations only to support mission operations. Solid exterior doors shall be of steel construction, factory primed, field painted, with stainless steel hinges and brushed chrome hardware.
5. Automatic doors are allowed only where functionally necessary.
6. Limit hollow metal doors and frames to security doors, utility rooms and mechanical rooms in Groups 1 and 2 and to any application in Group 3 facilities.
7. Passive thermal comfort methods of ventilation are encouraged where life cycle cost justified.
8. Windows and doors must meet force protection requirements.
9. Adjacent joint sealants should be slightly darker than the frame color.
10. Manufacturers listed below are only provided to establish a baseline of equivalency among all applicable manufacturers.

## **D06.2. Layout and Geometry**

1. Consider wind loading and direction when designing exterior entry and service doors.
2. Visually and functionally compose openings in walls for the climate-specific exposure.
3. Consistently use opening type, size, placement, mullion pattern, and color to reinforce the overall architectural design.
4. Openings shall augment interior lighting and space conditioning needs.
5. Protect against vandalism, intrusion and coordinate sound ratings.

## **D06.3. Glazing and Shading**

1. Bronze tinted, energy-efficient, low-e, double-pane glazing is standard.
2. Glazing color shall follow Installation Facilities Standards (IFS).
3. Translucent wall panels may be integrated into wall systems.
4. Do not use mirrored glazing.
5. Fully integrate applicable shading designs for overhangs, louvers, light shelves and grilles.
6. Where appropriate, install window screens to take advantage of natural ventilation.

## **D06.4. Hardware**

1. Provide hardware appropriate for the Facility Group while considering activity and frequency of use and local climate; hardware may be of higher visual quality for Facility Group 1.

2. Ensure hardware will perform throughout the facility's lifespan without showing extreme wear.
3. Select finishes that will not degrade by intensity of operation or exposure to the elements.
4. Use consistent finishes and color on window and door systems throughout a facility. For renovation projects the color of new hardware may match the existing hardware.
5. Electronic security systems or security glazing are preferred over physical screens or bars. Where physical barriers are required, develop simple rectangular designs that are unobtrusive.

## D06.5. Doors and Windows Materials

**Note:** Apply the below base-wide standards for Doors and Windows (products, materials and color). Then refer to the Appendix and apply any additional requirements specifically related to the Facility District in which the project is located.

### D06.5.1. Anodized Aluminum

Applicable    N/A   Number of base standards 2

Image Tool 250 x 188



Type: **Anodized Aluminum Doors and Frames**

Applies to:    Group 1    Group 2    Group 3    Group 4    Other

Mfr: Kawneer (or equivalent)

Color: Dark Bronze Anodized

Finish: Matte

Model #: 2x4

Other: Provide thermally broken frames

UFGS: Section 08 41 13 Aluminum-Framed Entrances and Storefronts:  
<http://www.wbdg.org/FFC/DOD/UFGS/UFGS 08 41 13.pdf>

Type: **Anodized Aluminum Windows and Frames**



Applies to:  Group 1  Group 2  Group 3  Group 4  Other

Mfr: Kawneer (or equivalent)

Color: Dark Bronze Anodized

Finish: Matte

Model #: 2x4

Other: Operable windows may be furnished; Provide thermally broken frames

UFGS: Section 08 41 13 Aluminum-Framed Entrances and Storefronts:  
<http://www.wbdg.org/FFC/DOD/UFGS/UFGS 08 41 13.pdf>

### D06.5.2. Hollow Metal

Applicable  N/A

Number of base standards 2

Image Tool 250 x 188

Type: **Hollow Metal Doors and Frames**



Applies to:  Group 1  Group 2  Group 3  Group 4  Other

Mfr: Steelcraft (or equivalent)

Color: Dark Brown

Finish: Powder Coated, Satin

Model #: 2x4 frame

Other: Provide thermally broken frames

UFGS: Section 08 11 13 Steel Doors and Frames:  
<http://www.wbdg.org/FFC/DOD/UFGS/UFGS 08 11 13.pdf>





Type: **Hollow Metal Windows and Frames**

Applies to:  Group 1  Group 2  Group 3  Group 4  Other

Mfr: Steelcraft (or equivalent)

Color: Dark Brown

Finish: Powder Coated, Satin

Model #: 2x4 or 2x6 engineered frame

Other: Provide thermally broken frames

UFGS: Section 08 11 13 Steel Doors and Frames:  
<http://www.wbdg.org/FFC/DOD/UFGS/UFGS 08 11 13.pdf>

### D06.5.3. Aluminum-clad Wood

Applicable  N/A Number of base standards 1

Image Tool 250 x 188



Type: **Aluminum-clad Residential**

Applies to:  Group 1  Group 2  Group 3  Group 4  Other

Mfr: Marvin

Color: White or Earth tones

Finish: Powder coated, satin

Model #: Aluminum-clad wood windows

Other: Double hung or casement

UFGS: Section 08 14 00 Wood Doors  
<http://www.wbdg.org/FFC/DOD/UFGS/UFGS 08 14 00.pdf>

### D06.5.4. Other

Applicable  N/A Number of base standards 2

Image Tool 250 x 188

Type: **Glass Masonry Units**

---

Applies to:  Group 1  Group 2  Group 3  Group 4  Other

Mfr: **Pittsburg Corning**

---

Color: **Translucent glass**

---

Finish: **Factory**

---

Model #: **12x12, Decora or Clear**

---

Other: **Stack bond pattern**

---

UFGS: **Section 04 23 00 Glass Unit Masonry**  
<https://www.wbdg.org/FFC/DOD/UFGS/UFGS%2004%2023%2000.pdf>

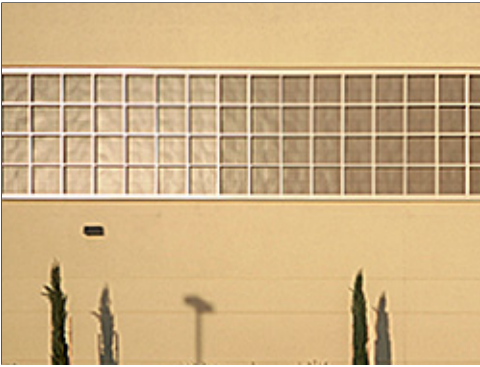

Type: \_\_\_\_\_

---

Applies to:  Group 1  Group 2  Group 3  Group 4  Other

Mfr: **Kalwall (or equivalent)**

---

Color: **Off-white or light beige**

---

Finish: **Factory**

---

Model #: **4" Wall Panel System**

---

Other: **N/A**

---

UFGS: **Section 08 45 23 (Not available on UFGS)**





## D07. ROOF SYSTEMS

Comply with AF Corporate Standards for Facilities Exteriors:

<http://afcs.wbdg.org/facilities-exteriors/index.html>

Comply with AF Corporate Standards for Roof Systems:

<http://afcs.wbdg.org/facilities-exteriors/roof-systems/index.html>

Comply with AFCFS Recommended Materials:

<http://afcs.wbdg.org/facilities-exteriors/roof-systems/materials/index.html>

*Insert 3 photos for each facility group.*

Image Tool 250 x 188

Group 1



Group 2



Group 3



Group 4





## D07.1. Roof Type and Form

1. Use proven, cost-effective roof systems with high durability, weather resistance, and low maintenance that are compatible with Installation Facilities Standards (IFS) and requirements for the designated Facility Group.
2. Generally match the roof type and form of existing adjacent facilities in new construction.
3. Group 1, 2 and 3 buildings shall use standing seam metal roofs with a min 3:12 pitch. Use factory-finished, mechanically seamed, standing seam metal roofing on sloped roofs with an 18-inch maximum wide panel, 22 gauge minimum thickness and a 2-inch raised standing seam. Metal roofing shall be terra cotta color and flashing shall match the roof material and color.
4. Built up roofing may be used on low sloped roofs with parapets or existing low slope roofs as a replacement in kind. Membrane roofing for low sloped roofs may only be used with ACRB approval.
5. Provide screens for roof-mounted appendages and equipment of the same materials, which are used predominantly in the building's roof systems.
6. Group 2 and 3 facilities under 5,000 sf and narrow in plan geometry, may use low-sloped shed, gabled or hipped standing seam metal roofs. Larger facilities may use sloped-roof features in conjunction with predominantly minimal-sloped "flat" membrane roofs. Insulated, mechanically seamed, standing seam roof panel system may be used for large flightline or industrial facilities. If used, system shall have seam/ribs at 30 inch spacing maximum.
7. Group 4 facilities shall have gabled or hipped composite shingle roofs.
8. Roof eaves shall extend beyond the exterior wall for roof drainage and shading. Provide overhangs for shading in response to local climatic conditions, sized and proportioned to the height of the facility and to the window openings being shaded.
9. South-facing eaves shall coordinate with adjacent wall-mounted shading devices.
10. The color, shape and slope of the eave and soffit shall be compatible with adjacent facilities.
11. Keep roofs uncluttered and minimize penetrations.
12. Diminish massive roofs into coordinated smaller components consistent with adjacent facilities; avoid random, arbitrary changes.
13. Increase the insulation value of existing roofing systems during renovations if supported by life cycle cost and structural analysis.
14. Roofs shall be maintained for the life of the system and replaced in accordance with UFC 3-110-04 and AFI 32-1051. A warranty is required on all new roofs. All low slope roofs lower than 3:12 will require a 20-year warranty.
15. Manufacturers listed below are only provided to establish a baseline of equivalency among all applicable manufacturers.

## D07.2. Roof Slope

1. Groups 1, 2, 3 and 4 buildings shall use 4:12 roof slope wherever possible. Roof slopes from 3:12 to 5:12 are acceptable alternate if approved by the ACRB.
2. Hipped roofs are preferred for most buildings. Gable and Dutch-hip roofs are acceptable if approved by the ACRB.
3. Open gabled elements may be used to accent entries.
4. Low-sloped roofs are only allowed for larger structures or to match existing conditions on renovation projects. Minimum slope is ½:12.

5. Flat roof with mansard parapet is acceptable for renovation projects and new construction if approved by the ACRB and Base Civil Engineer.
6. Ensure adequate drainage, and connect to the subsurface rain collection system where available.
7. Provide roof slopes to accommodate solar photovoltaic, solar thermal, passive systems and daylighting when applicable following UFC 1-200-02.
8. Provide underlayments as required for the roofing type as directed by the UFC.

### **D07.3. Parapets and Copings**

1. Extend wall materials vertically above the roof line and provide metal copings to match the wall. Ensure copings are properly flashed and detailed to avoid roof leaks.
2. Sloped parapets on the gabled end walls shall match the roof slope.
3. Use factory finished metal copings on all parapet walls. Architectural precast copings may be used with approval of the ACRB. Color shall match adjacent wall color.

### **D07.4. Color and Reflectivity**

1. Sloped roofs in Groups 1 and 2 and smaller facilities in Group 3 shall be terra cotta in color to match adjacent facilities and follow requirements of IFS.
2. All minimal-slope membrane roofs shall use only use high-albedo, high reflectivity color to help decrease the temperature around the buildings and minimize damage to human and wildlife habitat.
3. Sloped roofs in Group 4 shall be earth tones.
4. Comply with UFC 3-110-03 and ASHRAE 90.1 for Solar Reflectance Index (SRI) and thermal requirements.
5. All roof flashing shall match the roof material and color.

### **D07.5. Gutters, Downspouts, Scuppers, Drains**

1. All sloped roofs shall use gutters and downspouts. Gutters shall be outside the fascia.
2. Internal roof drainage systems are not permitted in new construction. Minimal-sloped roofs shall be sloped to drain to the building perimeter through scuppers into downspouts.
3. All gutters and fascias shall match the roof color when used with metal roofing. Incorporate continuous metal fascias that are scaled to match the roof. Size them 8 inches minimum and 14 inches maximum in height. Avoid the use of turn-down standing seam metal fascias.
4. Size the roof drainage system per IBC and SMACNA for the region.
5. Use scuppers as required in parapet walls. Arrange scuppers in an orderly manner consistent with other elements of the wall system.
6. When open scuppers are connected to downspouts, provide transitions consistent with adjacent facilities.
7. Integrate downspouts with the architectural details of the wall system and arrange in an orderly, non-prominent appearance. Generally blend downspouts with the color of the adjacent wall (not contrasting it).
8. Fabricate downspouts from non-corrosive materials such as aluminum or zinc-coated steel. Provide powder-coated factory finishes rather than field painted.

9. All downspouts shall be seamless.
10. Provide angled transitional pieces for downspouts to fit closely against the wall for their entire length. Limit the use of angle rain water leaders to the extent possible.
11. Coordinate locations of downspouts to conceal control joints in masonry walls when possible.
12. Place downspouts away from building entries. Use underground discharge when possible through sub-surface storm drains. Otherwise at a minimum, provide splash blocks or paved channels at the base of downspouts to divert water away from the building foundation. Water discharged should not run across sidewalks.

#### **D07.6. Roof Vents and Elements**

1. Minimize and consolidate roof penetrations into a single, inconspicuous point whenever possible.
2. On sloped roofs clad pipe penetrations to match the roofing material.
3. Avoid the use of rooftop mechanical equipment, however for renovations and unavoidable configurations ensure units are screened to match roof color.
4. Provide access points and cat walks or additional membrane pads along service routes to equipment to protect the roof from wear and penetrations.
5. Screen all large vents. Make mechanical vent sizes and shapes consistent with architectural elements.
6. Ensure attic spaces are properly vented at ridges and soffits.
7. Match roof color for all exposed equipment and vents.
8. Avoid roof-mounted antenna systems.
9. Arrange Lightning Protection Systems (LPS) components in an ordered, uncluttered, inconspicuous appearance and integrated into the organization of the roof and wall systems.
10. Ensure that LPS roof mounting systems are approved by the roofing manufacturer.
11. Additions to a roof shall not interfere with LPS or other rooftop systems that may be required.
12. Permanent fall protection shall be included with any addition to a roof with a slope above 3:12 per UFC 3-110-03 to a roof with a slope above 3:12 per UFC 3-110-03.
13. Expansion joints on roofs shall be raised on curbs and covered with metal coping and flashing to ensure a watertight finish.

#### **D07.7. Clerestories and Skylights**

1. Clerestories and skylights are permitted in Group 1 facilities. These are allowed in Group 3 facilities only when serving passive systems and are justifiable by life-cycle analysis.
2. Clerestories are preferred to skylights to avoid roof penetrations. Skylights, when permitted, must be simple in shape and integrated with the roof system to eliminate leakage.
3. Design clerestories and skylights using the same principles for seasonal shading that are required for walls and roof overhangs.
4. Translucent panel systems are preferred in clerestory applications due to lack of window cleaning.



5. Clerestories and skylights must comply with UFC 4-10-01.

### D07.8. Vegetated Roof

1. Not applicable.

### D07.9. Roof Systems Materials

**Note:** Apply the below base-wide standards for Roof Systems (products, materials and color). Then refer to the Appendix and apply any additional requirements specifically related to the Facility District in which the project is located.

#### D07.9.1. Standing Seam Metal

Applicable  N/A      Number of base standards 1

Image Tool 250 x 188



Type: **Style 1**

Applies to:  Group 1  Group 2  Group 3  Group 4  Other

Mfr: Berridge

Color: Terra Cotta

Finish: Matte

Model #: TBD

Other: Shed, gabled or hipped standing seam metal. Cool roof options preferred.

UFGS: Section 07 61 14 Steel Standing Seam Roofing  
<http://www.wbdg.org/FFC/DOD/UFGS/UFGS.07.61.14.00.20.pdf>

### D07.9.2. Membrane Single-ply

Applicable  N/A Number of base standards 1

Image Tool 250 x 188



Type: **Style 1**

Applies to:  Group 1  Group 2  Group 3  Group 4  Other

Mfr: Carlisle Systems

Color: Off-white

Finish: Smooth

Model #: TPO single-ply, "flat" minimal slope

Other: N/A

UFGS: Section 07 53 23 Ethylene-Propylene-Diene-Monomer Roofing  
[http://www.wbdg.org/FFC/DOD/UFGS/UFGS\\_07\\_53\\_23.pdf](http://www.wbdg.org/FFC/DOD/UFGS/UFGS_07_53_23.pdf)  
Section 07 54 50 TPO Thermoplastic Single-Ply Roofing  
(Not Available on UFGS)

### D07.9.3. Built-up Multi-ply

Applicable  N/A Number of base standards 1

Image Tool 250 x 188



Type: **APP Modified Bitumen**

Applies to:  Group 1  Group 2  Group 3  Group 4  Other

Mfr: GAF

Color: Beige Cap Sheet

Finish: Granulated Cap Sheet

Model #: Tri-Ply BUR

Other: N/A

UFGS: Section 07 51 13 Built-Up Asphalt Roofing  
[http://www.wbdg.org/FFC/DOD/UFGS/UFGS\\_07\\_51\\_13.pdf](http://www.wbdg.org/FFC/DOD/UFGS/UFGS_07_51_13.pdf)

### D07.9.4. Concrete Tile

Applicable  N/A

### D07.9.5. Clay Tile

Applicable  N/A

Number of base standards 1

Image Tool 250 x 188



Type: **S-Tile or Barrel Tile**

Applies to:  Group 1  Group 2  Group 3  Group 4  Other

Mfr: Ludowici

Color: Terra Cotta

Finish: Factory

Model #: S or Barrel

Other: N/A

UFGS: Section 07 32 13 Clay Roof Tiles  
(Not Available on UFGS)  
Section 07 32 14 Clay Tile Roofing Replacement or Repair  
<http://www.wbdg.org/FFC/DOD/UFGS/UFGS 07 32 14.pdf>

### D07.9.6. Slate Shingles

Applicable  N/A

### D07.9.7. Vegetated System

Applicable  N/A



### D07.9.8. Ribbed Metal Sheeting

Applicable  N/A

Number of base standards 1

Image Tool 250 x 188

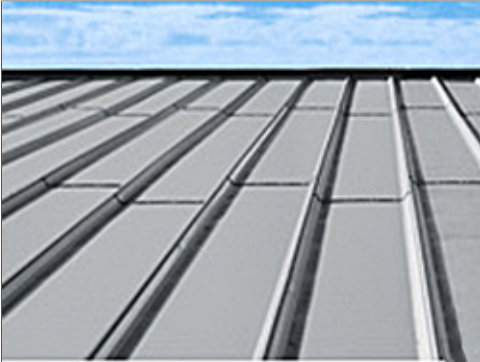

Type: **Style 1**

Applies to:  Group 1  Group 2  Group 3  Group 4  Other

Mfr: Berridge

Color: Galvalume

Finish: Factory

Model #: High Seam Tee-Panel

Other: 24 gauge steel, Width: 16" Batten height: 1-3/4  
Use for repairs only to match existing when partial tear off is needed.  
Otherwise refer to standards for standing seam metal roof requirements

UFGS: Section 07 41 13.19 Batten-Seam Metal Roof Panels  
(Not Available on UFGS)

### D07.9.9. Composite Shingles

Applicable  N/A

Number of base standards 1

Image Tool 250 x 188



Type: **Style 1**

Applies to:  Group 1  Group 2  Group 3  Group 4  Other

Mfr: Tamko

Color: Earth Tones

Finish: Factory

Model #: Heritage

Other: Gabled or hipped with transverse gable or hipped features

UFGS: Section 07 31 13 Glass-fiber-reinforced Asphalt Shingles  
[http://www.wbdg.org/FFC/DOD/UFGS/UFGS\\_07\\_31\\_13.pdf](http://www.wbdg.org/FFC/DOD/UFGS/UFGS_07_31_13.pdf)

### D07.9.10. Other

Applicable  N/A

## D08. STRUCTURAL SYSTEMS

Comply with AF Corporate Standards for Facilities Exteriors:

<http://afcs.wbdg.org/facilities-exteriors/index.html>

Comply with AF Corporate Standards for Structural Systems:

<http://afcs.wbdg.org/facilities-exteriors/structural-systems/index.html>

Comply with AFCFS Recommended Materials:

<http://afcs.wbdg.org/facilities-exteriors/structural-systems/materials/index.html>

Insert 3 photos for each facility group.

Image Tool 250 x 188

Group 1



Group 2



Group 3



Group 4





## D08.1. Systems and Layouts

1. Pre-engineered structural steel framing may be used for Groups 1, 2 and 3 facilities; Installation-appropriate thermal envelopes, materials and detailing are required.
2. Select economical structural systems that integrate roof and wall systems.
3. Narrow buildings 60' or less in width with column-free interiors are preferred for office, administrative and personnel spaces; when interior columns are required optimize the structural grid layout for open-plan arrangements.
4. Fully coordinate structural grids with exterior window systems to align columns with window frames or wall systems.
5. When structure is exposed provide an organized appearance and coordinate with mechanical, electrical, plumbing, fire protection, information technology, and communications systems.
6. Limit the use of specialty systems (such as space frames, vaults or domes) and of structure as a visual feature.
7. Cost-effectively design interior bearing walls as thermal mass.

## D08.2. Structural Systems Materials

**Note:** Apply the below base-wide standards for Structural Systems (products, materials and color). Then refer to the Appendix and apply any additional requirements specifically related to the Facility District in which the project is located.

### D08.2.1. Concrete

Applicable  N/A

### D08.2.2. Insulated Concrete Forming (ICF)

Applicable  N/A

### D08.2.3. Steel

Applicable  N/A Number of base standards 1

Image Tool 250 x 188



Type: **Rigid Framing**

Applies to:  Group 1  Group 2  Group 3  Group 4  Other

Mfr: US Steel

Color: Shop primed

Finish: Matte

Model #: Structural steel shapes

Other: N/A

UFGS: Section 05 12 00 Structural Steel  
[http://www.wbdg.org/FFC/DOD/UFGS/UFGS\\_05\\_12\\_00.pdf](http://www.wbdg.org/FFC/DOD/UFGS/UFGS_05_12_00.pdf)



### D08.2.4. Pre-Engineered Steel

Applicable  N/A

Number of base standards 1

Image Tool 250 x 188



Type: **Moment Frame**

Applies to:  Group 1  Group 2  Group 3  Group 4  Other

Mfr: Behlen Building Systems

Color: Factory primed

Finish: Matte

Model #: Moment Frame

Other: Draped insulation may be used behind wall system; Behlen standing seam roof system may be used for Group 3. Ensure deflection values are consistent with IBC requirements for masonry veneer.

UFGS: Section 13 12 00 Steel Building Systems  
(Not Available on UFGS)

Section 13 34 19 Metal Building Systems

[http://www.wbdg.org/FFC/DOD/UFGS/UFGS\\_13\\_34\\_19.pdf](http://www.wbdg.org/FFC/DOD/UFGS/UFGS_13_34_19.pdf)

### D08.2.5. Masonry

Applicable  N/A

Number of base standards 1

Image Tool 250 x 188



Type: **Reinforced Concrete Masonry Units**

Applies to:  Group 1  Group 2  Group 3  Group 4  Other

Mfr: Basalite

Color: Tan

Finish: Split Face

Model #: 8x16 nominal size, running bond

Other: N/A

UFGS: Section 04 20 00 Unit Masonry

[http://www.wbdg.org/FFC/DOD/UFGS/UFGS\\_04\\_20\\_00.pdf](http://www.wbdg.org/FFC/DOD/UFGS/UFGS_04_20_00.pdf)

### D08.2.6. Heavy Timber

Applicable  N/A

### D08.2.7. Light-gauge Steel

Applicable  N/A      Number of base standards 1

Image Tool 250 x 188



Type: **Style 1**

Applies to:  Group 1  Group 2  Group 3  Group 4  Other

Mfr: Steelrite

Color: Factory

Finish: Galvanized

Model #: Structural framing shapes

Other: N/A

UFGS: Section 05 45 00 Light Gauge Steel Framing System  
(Not Available on UFGS)

### D08.2.8. Lumber Framing

Applicable  N/A      Number of base standards 1

Image Tool 250 x 188



Type: **Style 1**

Applies to:  Group 1  Group 2  Group 3  Group 4  Other

Mfr: Boise Cascade Wood Products

Color: N/A

Finish: S4S

Model #: Structural dimensional lumber

Other: N/A

UFGS: Section 06 10 00 Rough Carpentry  
[http://www.wbdg.org/FFC/DOD/UFGS/UFGS\\_06\\_10\\_00.pdf](http://www.wbdg.org/FFC/DOD/UFGS/UFGS_06_10_00.pdf)  
Section 06 11 00 Wood Framing and Sheathing  
(Not Available on UFGS)

### D08.2.9. Other

Applicable  N/A



## D09. MECHANICAL, ELECTRICAL AND PLUMBING

Comply with AF Corporate Standards for Facilities Exteriors:

<http://afcs.wbdg.org/facilities-exterior/index.html>

Comply with AF Corporate Standards for Mechanical, Electrical and Plumbing:

<http://afcs.wbdg.org/facilities-exterior/mechanical-electrical-and-plumbing/index.html>

Insert 3 photos for each facility group.

Image Tool 250 x 188

Group 1



Group 2



Group 3

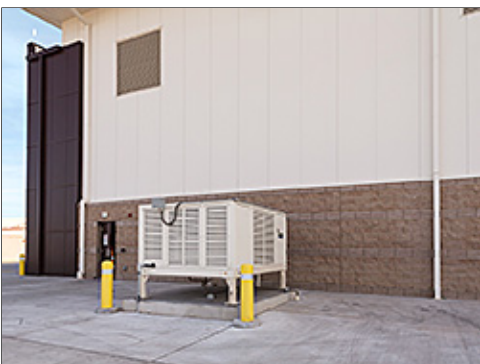

Group 4





### **D09.1. Passive and Active Systems**

1. Fully integrate passive heating and cooling systems into facility designs whenever practical for the local climate prior to the design of active mechanical systems.
2. Provide optimized passive and active systems; design active mechanical systems to supplement thermal mass walls and floors.
3. Develop renewable energy systems including geo-exchange (ground source heat pumps) when life cycle cost effective.
4. Performance display screens, which report energy performance and utility savings, are encouraged; when provided locate these in building lobbies or common areas.
5. Solar domestic hot water systems are required when life cycle cost effective for the climate.
6. Integrate shading into building exteriors to reduce solar heat gain during hot seasons.

### **D09.2. Functionality and Efficiency**

1. Fully coordinate mechanical, electrical, plumbing (MEP) and fire protection systems with each other and with the building structure, enclosure, thermal envelope and interior design.
2. Ensure direct exterior access is provided (for CE) to main mechanical and electrical rooms.
3. Screen exterior equipment from primary views (landscape, building masses, screen walls) and comply with AT/FP requirements.
4. Keep equipment away from main building entrances; locate service area/yard on least visible side of a building.
5. Coordinate the location of all exterior meters, equipment and devices to provide convenient access and an overall coordinated and orderly appearance.
6. Design emergency generator systems integrally with all other building systems and avoid incompatible building additions; locate generators near service areas and ensure they are not visible from primary entrances.
7. When structure is exposed as a finished ceiling, fully integrate MEP and fire protection systems to provide an organized uncluttered appearance.
8. Conceal ducts, piping, conduits, devices, etc., when permanent walls, suspended ceilings or raised floors are provided; locate sprinkler heads in orderly configuration.
9. Limit interior wall-mounted equipment in occupied personnel spaces; avoid surface-mounted conduit and pipes.
10. Provide efficient utility rooms with layouts to facilitate system performance and maintenance; provide convenient access to controls, clearly label systems and include operating and maintenance instructions.
11. Separate mechanical and electrical and communications rooms.
12. Integrate recessed and wall-mounted fixtures such as fire standpipe cabinets and drinking fountains within permanent walls.

## E. FACILITIES INTERIORS

Comply with Air Force Corporate Standards for Facilities Interiors:  
<http://afcs.wbdg.org/facilities-interiors/index.html>

*Insert 3 photos for each facility group.*

Image Tool 250 x 188

Group 1

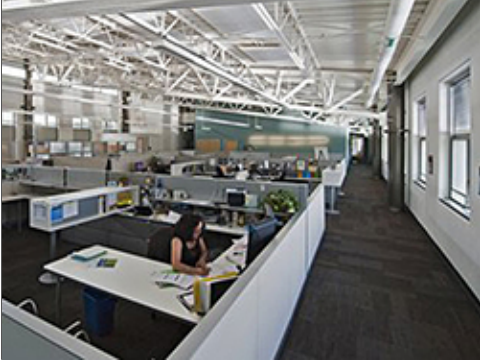

Group 2

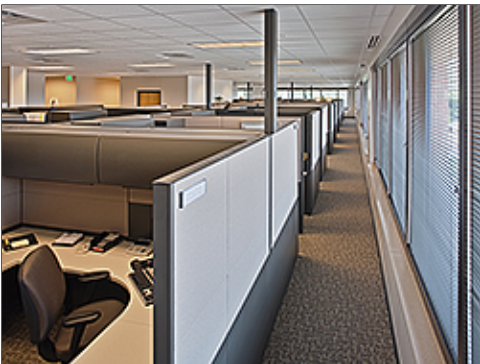

Group 3



Group 4



## E01. Building Configurations

Comply with Air Force Corporate Standards for Building Configurations:

<http://afcfs.wbdg.org/facilities-interiors/buildings-configurations/index.html>

1. Provide open-plan configurations for office, administrative, operational and related activities and spaces for maximum flexibility. Use a "core and shell" approach in which all building systems, infrastructure and permanent interior partitions anticipate two or more uses (operations) during a facility's lifespan.
2. Create flexible interior configurations using Furniture, Fixtures & Equipment (FF&E) and limit private offices and private rooms. Refer to AFMAN 32-1084 for space requirements. To the greatest extent, limit permanent partitions to core areas such as toilet rooms, stairs, mechanical and utility rooms.
3. Use more durable long-lasting finishes in core areas for walls, ceilings, floor coverings and built-in casework. Coordinate interior FF&E layouts with structural grids during space planning.
4. Provide high-performance building configurations following UFC 1-200-02. Ensure passive design strategies are cost effectively incorporated before active mechanical systems are designed.
5. Comply with UFC 1-200-01, general building requirements. UFC 1-200-01 provides applicability of model building codes and government unique criteria for typical design disciplines and building systems, as well as for accessibility, antiterrorism, security, high performance and sustainability requirements, and safety.
6. Meet security and force protection requirements in UFC 4-010-01: DoD Minimum Antiterrorism Standards for Buildings.
7. Comply with AFCFS for supporting mission requirements, addressing human comfort and well being, and creating highly flexible interiors while satisfying metrics for high performance and sustainable buildings.
8. Provide a level of quality for interior features, materials and finishes that is appropriate for the Facility Group number. Group 1 may receive higher quality than Groups 2 thru 4. Refer to Facility Hierarchy.
9. Through open-plan configurations, preserve all passive and natural design strategies and fully integrate facility interiors with overall building systems.
10. Professional interior designers, or architects with significant interior design experience, must accomplish the design and review of applicable new construction, renovations and maintenance projects.
11. Consult with the State Historic Preservation Officer (SHPO) and base-level Historic Preservation offices regarding proposed changes to properties listed on or eligible for listing on the National Register of Historic Places. Follow requirements of The National Historic Preservation Act and Secretary of the Interior Standards for the Treatment of Historic Properties.
12. Maintain architectural compatibility following AFCFS and this Installation Facilities Standards (IFS) document to create continuity while avoiding monotony.

### E01.1. Layout and Common Areas

Comply with Air Force Corporate Standards for Layout and Common Areas:

<http://afcfs.wbdg.org/facilities-interiors/buildings-configurations/layout-and-common-areas/index.html>

1. Create open-plan interior environments to accommodate changes.
2. Limit interior partitions, private offices and rooms; use furniture or modular systems to provide privacy and acoustic control.
3. When partitions are functionally justified such as for conference rooms, use systems furniture and moveable (demountable) floor-to-ceiling wall systems for acoustical or visual privacy.
4. Proportion lobbies and common spaces based on type of function, activity and facility group.
5. Allow no direct sight lines into restrooms.



6. Situate utility and core areas to minimize impact on daylighting and to maximize use as thermal buffers.
7. Ensure electrical, lighting and communications system can be adaptable to configuration changes.
8. Avoid power poles to the maximum extent; when poles are necessary minimize the number and coordinate locations with furniture placement and other elements.
9. Avoid sloping floors to maintain flexibility and eliminate future structural changes.
10. Special consideration may apply to Sensitive Compartmented Information Facilities (SCIFs).

### **E01.1.1. Interior Design Process**

1. Comply with UFC 3-120-10 for the Comprehensive Interior Design (CID,) which includes both Structural Interior Design (SID) and Furniture, Fixtures & Equipment (FF&E) design services.
2. Use a collaborative, integrated planning and design team, composed of user, government support staff, and appropriate professionals. Integrate architectural features using simple detailing to create a professional appearance; avoid extravagant or excessive detailing.
3. Ensure interior designs satisfy the functional requirements within the context of flexibility, sustainability and the building's energy performance.
4. Base space planning on square foot allocations from AFM 32-1084. Identify special requirements if any, such as privacy separation, VIP areas, gathering spaces and storage. Note: The occupant's rank and position will influence the square footage and selection of materials.
5. Provide clear circulation and pathway finding for both horizontal and vertical directions that accommodate the number of personnel in the facility.
6. Maximize efficiencies in the space plan for functional relationships and adjacencies for all facility users. Efficiently create and situate rooms and support rooms such as conference / meeting rooms and break rooms.
7. Provide interior design building-related illustrations, drawings, schedules, materials selections, specifications and cost estimates as listed in UFC 3-120-10. Refer to Furnishings in this IFS also.
8. SID Format shall follow HQ AFCEC standards.
9. Base the FF&E package on the furniture footprint developed in the SID. Identify all new or existing equipment needed and its users within each facility or each area of the facility. Provide specific information on: equipment sizes, electrical requirements, ventilation requirements, weight (if heavy), quantity, and security level if required. Presume all administrative spaces have computers and supporting equipment.

### **E01.1.2. Codes and Regulations**

1. Refer to UFC 1-200-01 for modifications to the International Building Code (IBC) to determine applicable sections of the IBC. Both the IBC Chapter 3 and UFC 3-600-01 govern "Use and Occupancy Classification" for example.
2. Fire code requirements shall be as defined in the International Building Code (IBC) and must be used where dictated by UFC 1-200-01 DoD Building Code (General Building Requirements) except where noted in UFC 3-600-01 (Fire Protection Engineering For Facilities).
3. National Fire Protection Association (NFPA) 101 must be utilized to determine the occupancy classification as it relates to fire/smoke resistance rating of interior non-load bearing partitions (other than occupancy separation), means of egress, interior finish, features of fire protection (including vertical openings) and associated requirements.

### **E01.2. Quality and Comfort**

Comply with Air Force Corporate Standards for Quality and Comfort:

<http://afcs.wbdg.org/facilities-interiors/buildings-configurations/quality-and-comfort/index.html>

1. Include durability in the life cycle cost analysis for best-value material selections with long life expectancies that do not show excessive wearing.
2. Select long-lasting materials and finishes for permanent core areas such as lobbies, restrooms and stairs.
3. Select low-maintenance materials and products that reduce ongoing servicing and repair and that are easy to clean.
4. Relate the visual quality of finishes to the Facility Group number.
5. Building and interior configurations should address both operations and climatic responses.
6. Convey a professional image; avoid trendy patterns and textures.
7. Use materials and finishes that provide a healthy indoor environment.
8. Orient interior spaces toward views while maintaining cost-effective building performance and efficiency.
9. Promote air movement and daylighting for human health and wellbeing.

## E02. Floors

Comply with Air Force Corporate Standards for Floors:

<http://afcs.wbdg.org/facilities-interiors/floors/index.html>

### E02.1. Floor Materials

**Facility Group 1** floor materials shall be as follows.

Primary: Prepared Slabs (Ground, Polished)

Secondary: Porcelain tile

Tertiary: Carpet, Rubber Stair Treads

**Facility Group 2** floor materials shall be as follows.

Primary: Prepared Slabs (Ground, Polished)

Secondary: Ceramic tile

Tertiary: Carpet, Rubber Stair Treads

**Facility Group 3** floor materials shall be as follows.

Primary: Prepared Slabs (Ground)

Secondary: Prepared Slabs (Sealer)

Tertiary: N/A

**Facility Group 4** floor materials shall be as follows.

Primary: Carpet

Secondary: Ceramic tile

Tertiary: N/A

1. Natural stone and terrazzo flooring may be used in high traffic areas of Group 1 as approved on a case basis.
2. Resilient and rapidly renewable flooring may be used in low traffic areas in Group 1, 2 and 4.

**Note:** Apply the below *base-wide standards* for Floors (products, materials and color). Then refer to the Appendix and apply any additional requirements specifically related to the Facility District in which the project is located.

## E02.1.1. Prepared Slabs

Applicable  N/A

Number of base standards 2

Image Tool 250 x 188



Type: **Style 1, Ground and Polished**

Applies to:  Group 1  Group 2  Group 3  Group 4  Other

Mfr: Local (TBD)

Color: Natural gray cement, light to dark beige aggregates

Finish: Fine polished texture

Model #: Medium to small aggregate

Other: N/A

UFGS: Section 03 35 45 Polished Concrete Finishing  
(Not Available on UFGS)

Type:

Applies to:  Group 1  Group 2  Group 3  Group 4  Other

Mfr: Local (TBD)

Color: Natural gray cement, light to dark beige aggregates

Finish: Medium polished texture, slip resistant

Model #: Medium to small aggregate

Other: N/A

UFGS: Section 03 35 45 Polished Concrete Finishing  
(Not Available on UFGS)





### E02.1.2. Natural Stone and Terrazzo

Applicable  N/A

Number of base standards 1

Image Tool 250 x 188



Type: **Ground and Polished Terrazzo**

Applies to:  Group 1  Group 2  Group 3  Group 4  Other

Mfr: Local (TBD)

Color: Natural gray cement, light to dark beige aggregates

Finish: Fine to medium polished texture, slip resistant

Model #: Medium to small aggregate

Other: N/A

UFGS: Section 09 63 40 Stone Flooring  
(Not Available on UFGS)  
Section 09 66 13 Portland Cement Terrazzo Flooring  
<http://www.wbdg.org/FFC/DOD/UFGS/UFGS 09 66 13.pdf>

### E02.1.3. Quarry Tile

Applicable  N/A

Number of base standards 1

Image Tool 250 x 188



Type: **Style 1**

Applies to:  Group 1  Group 2  Group 3  Group 4  Other

Mfr: Daltile

Color: Earth tones

Finish: Matte, slip resistant

Model #: N/A

Other: Use in commercial kitchen flooring.

UFGS: Section 09 30 10 Ceramic, Quarry, and Glass Tiling  
<http://www.wbdg.org/FFC/DOD/UFGS/UFGS 09 30 10.pdf>

## E02.1.4. Ceramic Tile

Applicable  N/A

Number of base standards 2

Image Tool 250 x 188



Type: **Style 1 Porcelain**

Applies to:  Group 1  Group 2  Group 3  Group 4  Other

Mfr: Daltile

Color: Earth tones

Finish: Matte, slip resistant

Model #: Porcelain tile

Other: Use in high traffic areas. Epoxy grout is recommended.

UFGS: Section 09 30 10 Ceramic, Quarry, and Glass Tiling  
<http://www.wbdg.org/FFC/DOD/UFGS/UFGS 09 30 10.pdf>

Type: **Style 2 Ceramic**

Applies to:  Group 1  Group 2  Group 3  Group 4  Other

Mfr: Daltile

Color: Earth tones

Finish: Matte, slip resistant

Model #: Ceramic tile

Other: Use in low traffic area toilet rooms.

UFGS: Section 09 30 10 Ceramic, Quarry, and Glass Tiling  
<http://www.wbdg.org/FFC/DOD/UFGS/UFGS 09 30 10.pdf>



### E02.1.5. Resilient Floor

Applicable  N/A

Number of base standards 1

Image Tool 250 x 188



Type: **Style 1 Stair Treads**

Applies to:  Group 1  Group 2  Group 3  Group 4  Other

Mfr: Roppe

Color: Neutral tones

Finish: Factory

Model #: Raised design rubber tread

Other: Stair treads material

UFGS: Section 09 65 00 Resilient Flooring

<http://www.wbdg.org/FFC/DOD/UFGS/UFGS 09 65 00.pdf>

### E02.1.6. Carpet

Applicable  N/A

Number of base standards 2

Image Tool 250 x 188

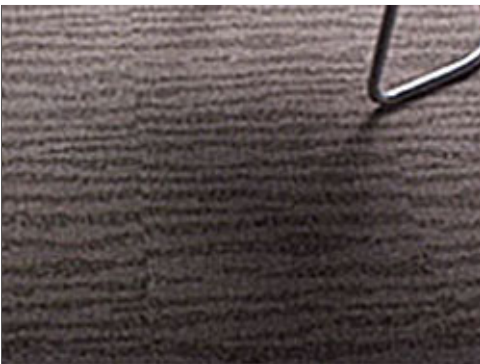

Type: **Style 1**

Applies to:  Group 1  Group 2  Group 3  Group 4  Other

Mfr: Mohawk Group

Color: Neutral multi-colored tones/patterned/solid

Finish: Yarn: Nylon 6 or 6.6/cut pile or loop pile

Model #: Broadloom, 6' wide rolled, carpet tiles, entry walk-off carpet

Other: N/A

UFGS: UFGS 09 68 00 Carpeting

<http://www.wbdg.org/FFC/DOD/UFGS/UFGS 09 68 00.pdf>





Type: **Style 2**

Applies to:  Group 1  Group 2  Group 3  Group 4  Other

Mfr: Mohawk Group

Color: Earth tones

Finish: Factory

Model #: Broadloom, residential loop, "Smartstrand"

Other: N/A

UFGS: UFGS 09 68 00 Carpeting  
[http://www.wbdg.org/FFC/DOD/UFGS/UFGS\\_09\\_68\\_00.pdf](http://www.wbdg.org/FFC/DOD/UFGS/UFGS_09_68_00.pdf)

### E02.1.7. Rapidly-Renewable Products

Applicable  N/A

### E02.1.8. Other

Applicable  N/A

## E03. Walls

Comply with Air Force Corporate Standards for Walls:  
<http://afcs.wbdg.org/facilities-interiors/walls/index.html>

### E03.1. Wall Materials

**Facility Group 1** wall materials shall be as follows.

Primary: CMU with plaster finish (or as approved)

Secondary: Gypsum board (painted)

Tertiary: Ceramic tile (restrooms)

**Facility Group 2** wall materials shall be as follows.

Primary: Brick

Secondary: Gypsum board (painted)

Tertiary: Ceramic tile (restrooms)

**Facility Group 3** wall materials shall be as follows.

Primary: Ground face CMU, sealed (do not paint)

Secondary: N/A

Tertiary: Ceramic tile (restrooms)

**Facility Group 4** wall materials shall be as follows.

Primary: Gypsum board (painted)

Secondary: N/A

Tertiary: Ceramic tile (restrooms)

1. Follow UFC 3-450-01 (Vibration and Noise Control) for acoustic design issues including speech privacy, sound isolation or sound masking.
2. Select and apply paint with sheens (gloss levels) appropriate for the application following UFGS Section 09 90 00 Paints and Coatings.
3. Provide ceramic tile on wet walls of kitchens, toilet rooms, locker rooms, etc., in all facility groups.
4. Neutral split-face or ground-face integrally colored block with a clear sealer may be used in Group 3. Do not paint block.
5. Provide rubber base on drywall partitions in Groups 1 and 2.
6. Hardwood base may only be used in Group 1 as approved on a case basis.
7. Hardwood chair rails / bumper rails may be used in high-use areas of Groups 1 and 2; aqueous clear finishes are preferred to reduce maintenance; plastic chair rails are permitted only in medical applications.
8. Decorative moldings may be used only in Group 1 when approved on a case basis.
9. Corner guards are permitted only in high traffic spaces with wheeled or cart use such as private service areas in Groups 1 and 2; stainless steel corners guards with a brushed finish may be judiciously used in Group 3.
10. Group 4 may use painted composite wood base.
11. Drywall shall be typically brought to a Level 4 finish; a Level 5 finish may be used in Group 1 facilities only.
12. Provide durable low-maintenance wall materials and finish for a long life span with the possibility of one or more uses of space during that time. Apply wall finishes assuming a 10-year lifespan. Color shall be neutral, cohesive and consistent quality throughout a facility.

**Note:** Apply the below base-wide standards for Walls (products, materials and color). Then refer to the Appendix and apply any additional requirements specifically related to the Facility District in which the project is located.

### **E03.1.1. Concrete**

Applicable  N/A

---

## E03.1.2. Masonry

Applicable  N/A

Number of base standards 2

Image Tool 250 x 188



Type: **CMU with Plaster Finish**

Applies to:  Group 1  Group 2  Group 3  Group 4  Other

Mfr: Local (TBD)

Color: Beige

Finish: Light texture

Model #: Plaster over CMU

Other: Plaster finished CMU is preferred for Groups 1 and 2. Exposed split face and ground face CMU may only be used in Group 3.

UFGS: Section 03 33 00 Cast-In-Place Architectural Concrete  
<http://www.wbdg.org/FFC/DOD/UFGS/UFGS 03 33 00.pdf>

Type: **CMU with Split Face or Ground Face**

Applies to:  Group 1  Group 2  Group 3  Group 4  Other

Mfr: Local (TBD)

Color: Beige

Finish: Split Face or Ground Face

Model #: 8x16 nominal size, running bond

Other: N/A

UFGS: Section 03 33 00 Cast-In-Place Architectural Concrete  
<http://www.wbdg.org/FFC/DOD/UFGS/UFGS 03 33 00.pdf>





### E03.1.3. Ceramic Tile

Applicable  N/A

Number of base standards 1

Image Tool 250 x 188

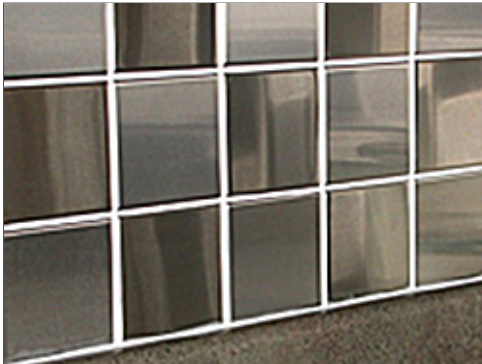

Type: **Style 1**

Applies to:  Group 1  Group 2  Group 3  Group 4  Other

Mfr: Daltile

Color: Earth tones

Finish: Gloss, Semi-gloss

Model #: Ceramic wall tile

Other: Located on wet walls in restrooms

UFGS: Section 09 30 10 Ceramic, Quarry, and Glass Tiling  
<http://www.wbdg.org/FFC/DOD/UFGS/UFGS 09 30 10.pdf>

### E03.1.4. Gypsum Board

Applicable  N/A

Number of base standards 1

Image Tool 250 x 188



Type: **Style 1**

Applies to:  Group 1  Group 2  Group 3  Group 4  Other

Mfr: US Gypsum

Color: Solid Earth tone colors

Finish: Paint (Sheen per UFGS)

Model #: Tapered edge

Other: N/A

UFGS: Section 09 29 00 Gypsum Board  
<http://www.wbdg.org/FFC/DOD/UFGS/UFGS 09 29 00.pdf>  
Section 09 90 00 Paints and Coatings  
<http://www.wbdg.org/FFC/DOD/UFGS/UFGS 09 90 00.pdf>

### E03.1.5. Metal Panels

Applicable  N/A

### E03.1.6. Wood Paneling

Applicable  N/A

---

### E03.1.7. Rapidly-Renewable Products

Applicable  N/A

---

### E03.1.8. Other

Applicable  N/A

---

## E04. Ceilings

Comply with Air Force Corporate Standards for Ceilings:  
<http://afcs.wbdg.org/facilities-interiors/ceilings/index.html>

### E04.1. Ceiling Materials

**Facility Group 1** ceiling materials shall be as follows.

Primary: Exposed Framing (Roof / Floor Structure Above)

Secondary: Grid and Acoustical Tile

Tertiary:

**Facility Group 2** ceiling materials shall be as follows.

Primary: Exposed Framing (Roof / Floor Structure Above)

Secondary: Grid and Acoustical Tile

Tertiary: Gypsum board (painted)

**Facility Group 3** ceiling materials shall be as follows.

Primary: Exposed Framing (Roof / Floor Structure Above)

Secondary: Exposed Framing (Roof / Floor Structure Above)

Tertiary: Gypsum board (painted)

**Facility Group 4** ceiling materials shall be as follows.

Primary: Gypsum board (painted)

Secondary: N/A

Tertiary: N/A

1. Accent ceiling materials such as metal, wood, and rapidly renewable may be used in Group 1 as approved on a case basis.
2. Follow UFC 3-450-01 (Vibration and Noise Control) for acoustic design issues including speech privacy, sound isolation or sound masking.
3. Structural roof/floor decks and other components (mechanical, plumbing, electrical, communications) may be exposed when cost effective to eliminate or minimize secondary suspended ceilings. Exposed structure and building components shall be painted a consistent, flat, neutral paint color.
4. All individual elements placed in ceiling or suspended from ceiling shall be coordinated throughout and have an ordered appearance. Light fixtures shall be symmetrical and balanced throughout a room. Suspended ceilings shall be centered in each room. Fixtures such as detectors, fire sprinklers, annunciators, etc. shall be centered in the ceiling tiles.

5. Limit the transmittance of sound through building components, the reflectance of sound within interior spaces and address acoustic design issues including speech privacy, sound isolation or sound masking as outlined in UFC 3-450-01, Noise and Vibration Control.

6. Accent ceiling materials such as metal, wood and rapidly renewable may be used in Group 1 as approved on a case by case basis.

**Note:** Apply the below *base-wide standards for Ceilings (products, materials and color)*. Then refer to the Appendix and apply any additional requirements specifically related to the Facility District in which the project is located.

### E04.1.1. Exposed Framing (Roof / Floor Structure Above)

Applicable  N/A

Number of base standards 1

Image Tool 250 x 188



Type: **Style 1**

Applies to:  Group 1  Group 2  Group 3  Group 4  Other

Mfr: Vulcraft

Color: Neutral colors reviewed on a case basis

Finish: Field painted (Sheen per UFGS)

Model #: Formlok floor and roof decking

Other: N/A

UFGS: Section 05 30 00 Steel Decks  
<http://www.wbdg.org/FFC/DOD/UFGS/UFGS 05 30 00.pdf>

### E04.1.2. Exposed Concrete

Applicable  N/A



### E04.1.3. Grid and Acoustical Tile

Applicable  N/A

Number of base standards 1

Image Tool 250 x 188



Type: **Style 1**

Applies to:  Group 1  Group 2  Group 3  Group 4  Other

Mfr: Armstrong

Color: White

Finish: Factory

Model #: 2'x2' Tegular with reveal edge and fine texture, grid 15/16"

Other: Performance characteristics are Class A; NRC-0.70; CAC-40; LR-0.86; minimum recycled content 82%.

UFGS: Section 09 51 00 Acoustical Ceilings  
<http://www.wbdg.org/FFC/DOD/UFGS/UFGS 09 51 00.pdf>

### E04.1.4. Gypsum Board

Applicable  N/A

Number of base standards 1

Image Tool 250 x 188



Type: **Style 1**

Applies to:  Group 1  Group 2  Group 3  Group 4  Other

Mfr: US Gypsum

Color: Solid neutral colors

Finish: Paint (sheen per UFGS)

Model #: Tapered edge

Other: N/A

UFGS: Section 09 29 00 Gypsum Board  
<http://www.wbdg.org/FFC/DOD/UFGS/UFGS 09 29 00.pdf>  
Section 09 90 00 Paints and Coatings  
<http://www.wbdg.org/FFC/DOD/UFGS/UFGS 09 90 00.pdf>

### E04.1.5. Metal Panels

Applicable  N/A

#### **E04.1.6. Wood**

Applicable  N/A

---

#### **E04.1.7. Rapidly-Renewable Products**

Applicable  N/A

---

#### **E04.1.8. Other**

Applicable  N/A

---

### **E05. Doors and Windows**

Comply with Air Force Corporate Standards for Doors and Windows:

<http://afcs.wbdg.org/facilities-interiors/doors-and-windows/index.html>

#### **E05.1. Doors and Windows and Frames Materials**

**Facility Group 1**

door (frame) and window frame materials shall be as follows.

Primary: Aluminum, clear anodized

Secondary: Hollow metal (painted)

Tertiary: N/A

**Facility Group 1**

door (leaf) materials shall be as follows.

Primary: Hardwood veneer

Secondary: Hollow metal (painted)

Tertiary: N/A

**Facility Group 2**

door (frame) and window frame materials shall be as follows.

Primary: Aluminum, clear anodized

Secondary: Hollow metal (painted)

Tertiary: N/A

**Facility Group 2**

door (leaf) materials shall be as follows.

Primary: Hardwood veneer

Secondary: Hollow metal (painted)

Tertiary: N/A

**Facility Group 3**

door (frame) and window frame materials shall be as follows.

Primary: Hollow metal (galvanized, painted)

Secondary: Hollow metal (galvanized, painted)

Tertiary: N/A

**Facility Group 3**

door (leaf) materials shall be as follows.

Primary: Hollow metal (galvanized, painted)

Secondary: Hollow metal (galvanized, painted)

Tertiary: N/A

**Facility Group 4**

door (frame) and window frame materials shall be as follows.

Primary: Wood

Secondary: N/A

Tertiary: N/A

**Facility Group 4**

door (leaf) materials shall be as follows.

Primary: Wood solid core

Secondary: Composite solid core

Tertiary: N/A

1. Hardwood casings may be provided over metal frames in Group 1 as approved on a case basis.
2. Paneled textured doors are preferred in Group 4.
3. Do not use hollow-core wood doors.
4. Generally match original hardware in renovations.
5. All locking hardware shall be Schlage, 6-pin cylinders, and provided with "construction cores", control key and interchangeable cores with blank keys. All work shall be coordinated with the base lock shop.

**Note:** Apply the below *base-wide standards* for Doors and Windows (products, materials and color). Then refer to the Appendix and apply any additional requirements specifically related to the Facility District in which the project is located.



### E05.1.1. Aluminum

Applicable  N/A

Number of base standards 1

Image Tool 250 x 188



Type: **Style 1**

Applies to:  Group 1  Group 2  Group 3  Group 4  Other

Mfr: Kawneer

Color: Clear anodized

Finish: Factory

Model #: InFrame Interior Framing, (2x4 nominal framing)

Other: Satin stainless steel hardware

UFGS: Section 08 41 13 Aluminum-Framed Entrances and Storefronts  
<http://www.wbdg.org/FFC/DOD/UFGS/UFGS 08 41 13.pdf>  
Section 08 71 00 Door Hardware  
<https://www.wbdg.org/FFC/DOD/UFGS/UFGS 08 71 00.pdf>

### E05.1.2. Hollow Metal

Applicable  N/A

Number of base standards 2

Image Tool 250 x 188



Type: **Steel Doors**

Applies to:  Group 1  Group 2  Group 3  Group 4  Other

Mfr: Steelcraft

Color: Neutral colors

Finish: Paint (Sheen per UFGS)

Model #: Hollow metal, 2" w. frames, 16 gauge (welded corners) grouted solid

Other: Provide in Group 3 and in utility areas of Group 1 and 2. Provide A25 "galvannealed" coating. All interior steel doors shall have a factory applied primer finish. Provide satin stainless steel hardware.

UFGS: Section 08 11 13 Steel Doors and Frames  
<http://www.wbdg.org/FFC/DOD/UFGS/UFGS 08 11 13.pdf>  
Section 08 71 00 Door Hardware  
<https://www.wbdg.org/FFC/DOD/UFGS/UFGS 08 71 00.pdf>

Type: **Steel Frames**

Applies to:  Group 1  Group 2  Group 3  Group 4  Other

Mfr: Steelcraft

Color: Neutral colors

Finish: Paint (Sheen per UFGS)

Model #: Hollow metal, frame grouted solid

Other: Satin stainless steel hardware

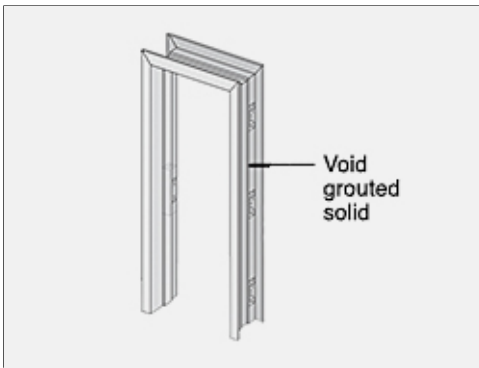

UFGS: Section 08 11 13 Steel Doors and Frames  
<http://www.wbdg.org/FFC/DOD/UFGS/UFGS 08 11 13.pdf>  
Section 08 71 00 Door Hardware  
<https://www.wbdg.org/FFC/DOD/UFGS/UFGS 08 71 00.pdf>

### E05.1.3. Wood

Applicable  N/A

Number of base standards 2

Image Tool 250 x 188

Type: **Style 1, Administrative**

Applies to:  Group 1  Group 2  Group 3  Group 4  Other

Mfr: Simpson

Color: Natural hardwood veneer

Finish: Clear Sealer, satin (aqueous)

Model #: 3'x7'x 1 3/4", solid core

Other: Satin stainless steel hardware, Glass lites may be used. Stained birch veneer face, 5 ply construction, rotary cut finish.



UFGS: Section 08 14 00 Wood Doors  
<http://www.wbdg.org/FFC/DOD/UFGS/UFGS 08 14 00.pdf>  
Section 08 71 00 Door Hardware  
<https://www.wbdg.org/FFC/DOD/UFGS/UFGS 08 71 00.pdf>

Type: **Style 2, Residential**



Applies to:  Group 1  Group 2  Group 3  Group 4  Other

Mfr: Simpson

Color: Natural hardwood veneer or paint grade

Finish: Clear Sealer or paint, satin (aqueous)

Model #: Full slab or panels

Other: Satin nickel hardware

UFGS: Section 08 14 00 Wood Doors

<http://www.wbdg.org/FFC/DOD/UFGS/UFGS 08 14 00.pdf>

Section 08 71 00 Door Hardware

<https://www.wbdg.org/FFC/DOD/UFGS/UFGS 08 71 00.pdf>

#### E05.1.4. Other

Applicable  N/A

### E06. Casework Systems

Comply with Air Force Corporate Standards for Casework Systems:

<http://afcfs.wbdg.org/facilities-interiors/casework-systems/index.html>

#### E06.1. Casework Materials

1. Select casework systems and materials considering durability, maintenance requirements and Life Cycle Cost Analysis (LCCA).
2. Cabinets, countertops and hardware shall be appropriate for the Facility Group and for the frequency of use. Materials should be durable and not susceptible to damage from regular use. Countertops shall be neutral in color, smooth or lightly textured and compatible with the adjacent cabinet surfaces and plumbing fixtures.
3. Materials shall convey a professional image without extravagance; comply with Architectural Woodwork Institute standards for custom cabinetry. Provide Premium Grade cabinetry in Group 1 facilities; provide Custom Grade cabinetry in Group 2 facilities.
4. Natural stone and cast stone countertops may only be used in Group 1 facilities with approval on a case by case basis.
5. Metal cabinets and countertops shall be provided in heavy-use operations and in select areas in Group 3.
6. Refer to Air Force Corporate Facility Standards (AFCFS) for approved materials.



### E06.1.1. Plastic Laminate

Applicable  N/A

Number of base standards 1

Image Tool 250 x 188



Type: **Style 1, Low Use Areas**

Applies to:  Group 1  Group 2  Group 3  Group 4  Other

Mfr: Formica

Color: Medium Earth tones and neutral tones

Finish: Light textured

Model #: High pressure laminate

Other: Combine with matching solid-surface banding on casework edges.

UFGS: Section 06 41 16.00 10 Plastic-Laminate-Clad Architectural Cabinets  
[http://www.wbdg.org/FFC/DOD/UFGS/UFGS\\_06\\_41\\_16.00\\_10.pdf](http://www.wbdg.org/FFC/DOD/UFGS/UFGS_06_41_16.00_10.pdf)

### E06.1.2. Solid Polymer Surface

Applicable  N/A

Number of base standards 1

Image Tool 250 x 188



Type: **Style 1, High Use Areas**

Applies to:  Group 1  Group 2  Group 3  Group 4  Other

Mfr: Corian

Color: Medium Earth tones and neutral tones

Finish: Light textured

Model #: Solid Surface

Other: Faces and edge banding

UFGS: Section 12 36 00 Countertops  
[http://www.wbdg.org/FFC/DOD/UFGS/UFGS\\_12\\_36\\_00.pdf](http://www.wbdg.org/FFC/DOD/UFGS/UFGS_12_36_00.pdf)

### E06.1.3. Rapidly-Renewable Products

Applicable  N/A

Number of base standards 1

Image Tool 250 x 188



Type: **Style 1 Moderate Use Areas**

Applies to:  Group 1  Group 2  Group 3  Group 4  Other

Mfr: Plyboo

Color: Natural or amber

Finish: Satin

Model #: Flat grain bamboo plywood

Other: FSC® Certified 100%.

UFGS: Section 12 32 00 Manufactured Wood Casework  
<http://www.wbdg.org/FFC/DOD/UFGS/UFGS 12 32 00.pdf>

### E06.1.4. Metal

Applicable  N/A

Number of base standards 1

Image Tool 250 x 188



Type: **Style 1**

Applies to:  Group 1  Group 2  Group 3  Group 4  Other

Mfr: Steel Sentry

Color: Natural stainless steel or neural colors (steel)

Finish: Mill (stainless) or Powder coated (steel)

Model #: Lab, workbench, computer workstation

Other: Provide highly durable fabrications and finishes in Group 3 which are subjected to heavy use.

UFGS: Section 12 31 00 Manufactured Metal Casework  
<http://www.wbdg.org/FFC/DOD/UFGS/UFGS 12 31 00.pdf>

### E06.1.5. Other

Applicable  N/A

---

## E06.2. Countertop Materials

### E06.2.1. Plastic Laminate

Applicable  N/A      Number of base standards 1

Image Tool 250 x 188



Type: **Style 1, Low Use Areas**

Applies to:  Group 1  Group 2  Group 3  Group 4  Other

Mfr: Formica

Color: Medium Earth tones and neutral tones

Finish: Light textured

Model #: High pressure laminate

Other: Only use rounded half or full bullnose and integral backsplash. Do not use plastic laminate edge banding on front edges.

UFGS: Section 06 41 16.00 10 Plastic-Laminate-Clad Architectural Cabinets  
[http://www.wbdg.org/FFC/DOD/UFGS/UFGS\\_06\\_41\\_16.00\\_10.pdf](http://www.wbdg.org/FFC/DOD/UFGS/UFGS_06_41_16.00_10.pdf)

---

### E06.2.2. Solid Polymer Surface

Applicable  N/A      Number of base standards 1

Image Tool 250 x 188



Type: **Style 1, High Use Areas**

Applies to:  Group 1  Group 2  Group 3  Group 4  Other

Mfr: Corian

Color: Medium Earth tones and neutral tones

Finish: Light textured

Model #: Solid Surface

Other: Faces and edges

UFGS: Section 12 36 00 Countertops  
[http://www.wbdg.org/FFC/DOD/UFGS/UFGS\\_12\\_36\\_00.pdf](http://www.wbdg.org/FFC/DOD/UFGS/UFGS_12_36_00.pdf)



### E06.2.3. Natural Stone

Applicable  N/A

Number of base standards 1

Image Tool 250 x 188



Type: **Style 1, Group 1 High Visibility, Heavy Use**

Applies to:  Group 1  Group 2  Group 3  Group 4  Other

Mfr: Local (TBD)

Color: Neutral tones

Finish: High polish, sealer

Model #: Custom cut slabs

Other: N/A

UFGS: Section 12 36 00 Countertops

[http://www.wbdg.org/FFC/DOD/UFGS/UFGS\\_12\\_36\\_00.pdf](http://www.wbdg.org/FFC/DOD/UFGS/UFGS_12_36_00.pdf)

### E06.2.4. Cast Stone

Applicable  N/A

Number of base standards 1

Image Tool 250 x 188

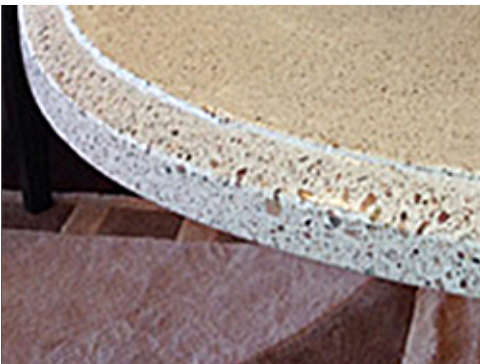

Type: **Style 1, Group 1 High Visibility, Heavy Use**

Applies to:  Group 1  Group 2  Group 3  Group 4  Other

Mfr: Local (TBD)

Color: Neutral tones

Finish: High polish, sealer

Model #: Custom cast or cut slabs

Other: N/A

UFGS: Section 12 36 00 Countertops

[http://www.wbdg.org/FFC/DOD/UFGS/UFGS\\_12\\_36\\_00.pdf](http://www.wbdg.org/FFC/DOD/UFGS/UFGS_12_36_00.pdf)

### E06.2.5. Metal

Applicable  N/A

Number of base standards 1

Image Tool 250 x 188

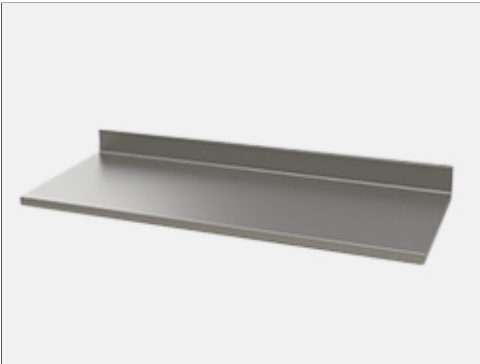

Type: \_\_\_\_\_

Applies to:  Group 1  Group 2  Group 3  Group 4  Other

Mfr: Local (TBD)

Color: Natural stainless steel

Finish: Mill

Model #: Custom fabricated countertops

Other: Provide integral fronts, sides and backsplash

UFGS: Section 12 31 00 Manufactured Metal Casework  
<http://www.wbdg.org/FFC/DOD/UFGS/UFGS 12 31 00.pdf>

### E06.2.6. Other

Applicable  N/A

## E07. Furnishings

Comply with Air Force Corporate Standards for Furnishings:  
<http://afcs.wbdg.org/facilities-interiors/furnishings/index.html>

### E07.1. Durability and Serviceability

Comply with AF Corporate Standards for Durability and Serviceability:  
<http://afcs.wbdg.org/facilities-interiors/furnishings/durability-and-serviceability/index.html>

### E07.2. Accessories

Comply with AF Corporate Standards for Accessories:  
<http://afcs.wbdg.org/facilities-interiors/furnishings/accessories/index.html>

## E08. Interior Signs

Comply with Air Force Corporate Standards for Interior Signs:  
<http://afcs.wbdg.org/facilities-interiors/interior-signs/index.html>

### E08.1 Types and Color

Comply with Air Force Corporate Standards for Types and Color:  
<http://afcs.wbdg.org/facilities-interiors/interior-signs/types-and-color/index.html>

## **E08.2. Interior Signs Materials**

1. Natural stone, masonry and cast stone signs may only be used in Group 1 with approval on a case basis.
2. Signage should be made to be as flexible as possible, allowing users to modify signage with removable inserts as needed to avoid costly changes to signage as needs and mission change.

## **E09. Lighting, Power and Communication**

<http://afcs.wbdg.org/facilities-interiors/lighting-power-and-communication/index.html>

### **E09.1. Functionality and Efficiency**

Comply with Air Force Corporate Standards for Functionality and Efficiency:  
<http://afcs.wbdg.org/facilities-interiors/lighting-power-and-communication/functionality-and-efficiency/index.html>

### **E09.2. Types and Color**

1. Use LED lighting where appropriate.
2. All lighting fixtures should provide a warm color spectrum, 3000K or less.

## F. APPENDIX - Facility Districts

- Applicable
- N/A

Comply with Air Force Corporate Standards for Facility Districts:

<http://afcs.wbdg.org/facility-districts/index.html>

Facilities Districts Overview Map:

Image Tool 800 x 600

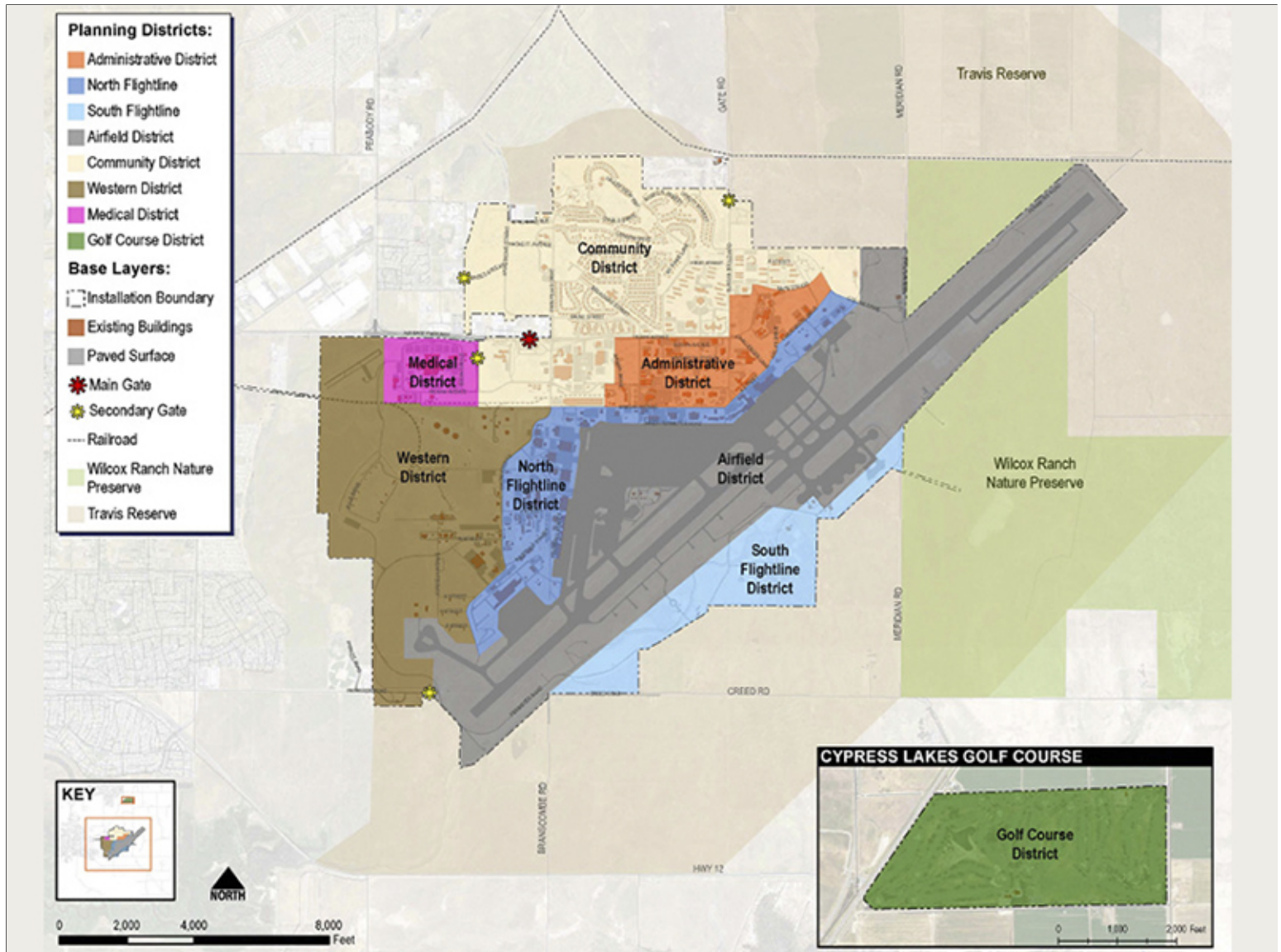

**Note:** Apply the *base-wide standards* in this IFS for Installation Elements, Site Development, Facilities Exteriors and Facilities Interiors (products, materials, color, etc.). Following application of the base-wide standards, refer to the Appendix and apply any additional requirements specifically related to the Facility District.

Enter No. of Facility Districts 2

The following Facility Districts list exceptions to the base standards that are unique to each district. Please refer to the Site Development, Facilities Exteriors, and Facilities Interiors sections of this IFS for base standards.



Image Tool 800 x 600

Map of District

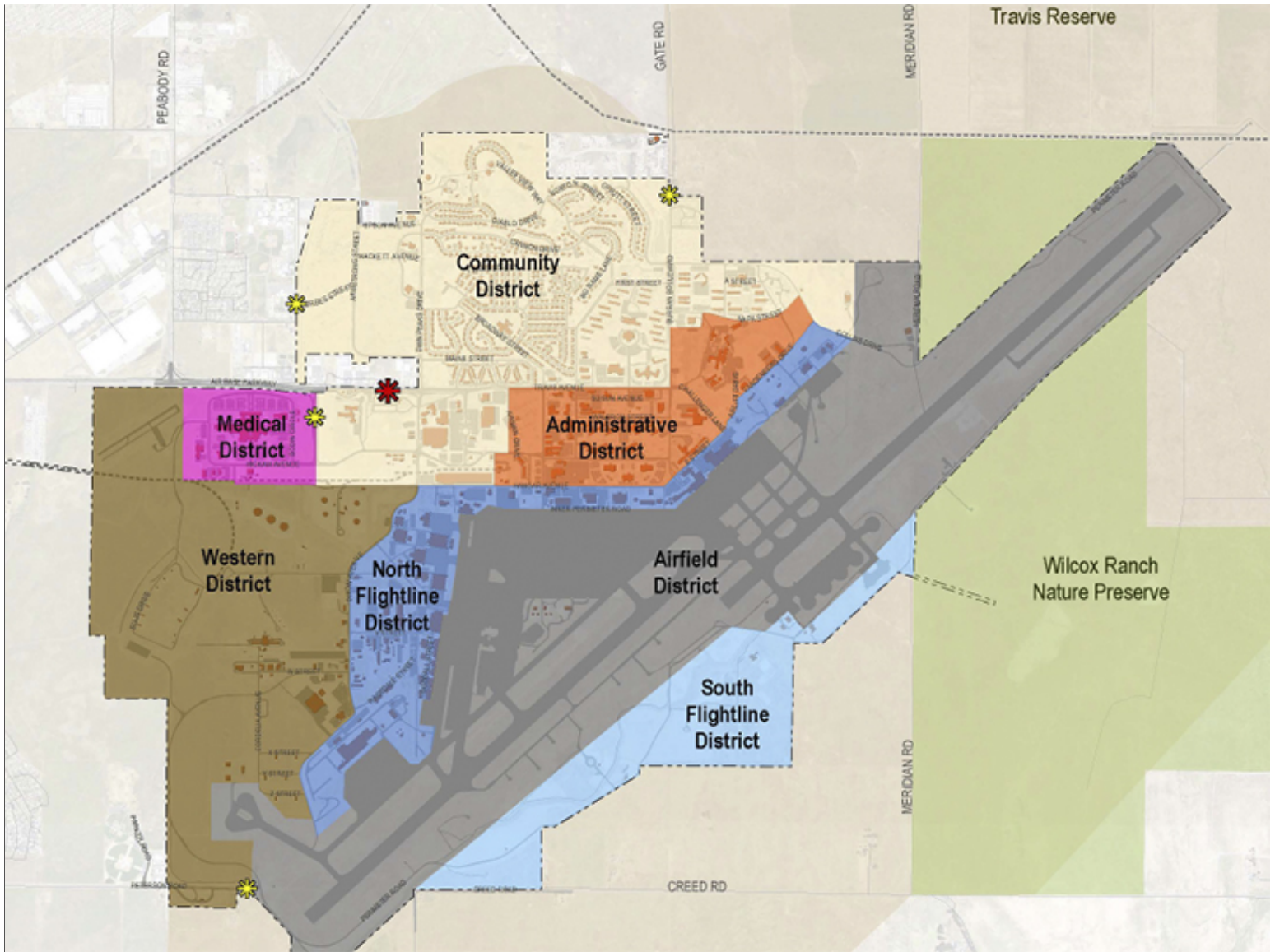

Photos for each facility group within the Facility District as applicable.

Image Tool 250 x 188

Group 1  Applicable  N/A

Group 2  Applicable  N/A

Group 3  Applicable  N/A

Group 4  Applicable  N/A

Other  Applicable  N/A

## **FACILITY DISTRICTS**

Travis Air Force Base is divided into planning districts that align with land uses as defined by the Installation Development Plan. Each district has designated uses that help to define the architectural response.

Facilities in all districts, except the Medical district, shall apply the installation's base-wide standards and prevailing architectural vernacular, which is a contemporary adaptation of Spanish Mission Revival architecture, during major renovations or new construction as appropriate. The Medical planning district, the David Grant medical campus, shall apply a post-modern theme as described below.

Generally match adjacent facilities in new construction to promote architectural compatibility throughout the installation. A brief description of each of the districts follows.

### **1. Administrative**

The Administrative district should continue to be pedestrian in scale. Application of the installation prevailing architectural vernacular, a contemporary adaptation of Spanish Mission Revival architecture, should be implemented during major renovations or new construction as appropriate.

### **2. North Flightline**

The North Flightline may be monumental in scale with pedestrian-scaled architectural features. Application of the installation prevailing architectural vernacular should be implemented during major renovations or new construction as appropriate. Facilities in this district are industrial in nature, should generally match adjacent buildings to ensure architectural compatibility, and shall follow standards for Facility Group 3 as defined in this IFS.

### **3. South Flightline**

The South Flightline may be monumental in scale with pedestrian-scaled architectural features. Application of the installation prevailing architectural vernacular should be implemented during major renovations or new construction as appropriate. Facilities in this district are industrial in nature, should generally match adjacent buildings to ensure architectural compatibility, and shall follow standards for Facility Group 3 as defined in this IFS.

### **4. Airfield**

The Airfield includes the entire airfield pavement system (runway, taxiway and apron), related open space, navigational aids, and aircraft operations and maintenance facilities. Buildings in the airfield architectural district are mostly comprised of aircraft support facilities such as hangars, shops, and terminals and are industrial in nature and should remain so. The only exceptions are the facilities used to welcome distinguished visitors who would arrive via the base runway; these facilities should be considered as Group 1.

### **5. Community**

The Community district contains facilities that support family and personnel needs to include family housing, temporary lodging facilities (TLF), TLF support, schools (nursery, elementary and junior high), adult education facilities, child care centers, youth center, chapel and religious education facilities, security police operations control, including visitor management and military operations security. Facilities in this district are, and should continue to be, pedestrian in scale. Application of the installation prevailing architectural vernacular should be implemented during major renovations or new construction as appropriate.

### **6. Western**

The Western district may be monumental in scale with pedestrian-scaled architectural features. Application of the installation prevailing architectural vernacular should be implemented during major renovations or new construction as appropriate. Facilities in this district are industrial in nature, should generally match adjacent buildings to ensure architectural compatibility, and shall follow standards for Facility Group 3 as defined in this IFS.

### **7. Medical**

The Medical district includes clinics and other health related services for day-to-day outpatient medical care, extended care, optometry, dental care and lab uses. Active duty military personnel, retired military and dependents living off base use these facilities. Facilities in this district are either pedestrian in scale or monumental in scale with pedestrian scaled entries that are appropriate. Application of the post-modern architectural theme, characterized by white plaster, red tile and aluminum panels, should be implemented during major renovations or new construction as appropriate.

### **8. Golf Course**

The Golf Course district includes facilities that are pedestrian in scale and, in many areas, are directly adjacent to open spaces further enhancing the aesthetic qualities of this district. Application of the installation prevailing architectural vernacular should be implemented during major renovations or new construction as appropriate; these facilities should be considered as Group 2.

**Open Space and Preserves**

Open space includes undeveloped land both inside and outside of the immediate cantonment area. It both separates and defines the various sections of the base and creates a natural setting for the cantonment area. Areas classified as open space may be undeveloped to act as a buffer space between incompatible uses or for safety or security clearances or there may be other constraints that are not readily visible. All development in open space requires prior coordination and approval from the Base Civil Engineer.

Image Tool 800 x 600

Map of District

TRAVIS AFB  
MEDICAL DISTRICT MAP

David Grant Medical Campus

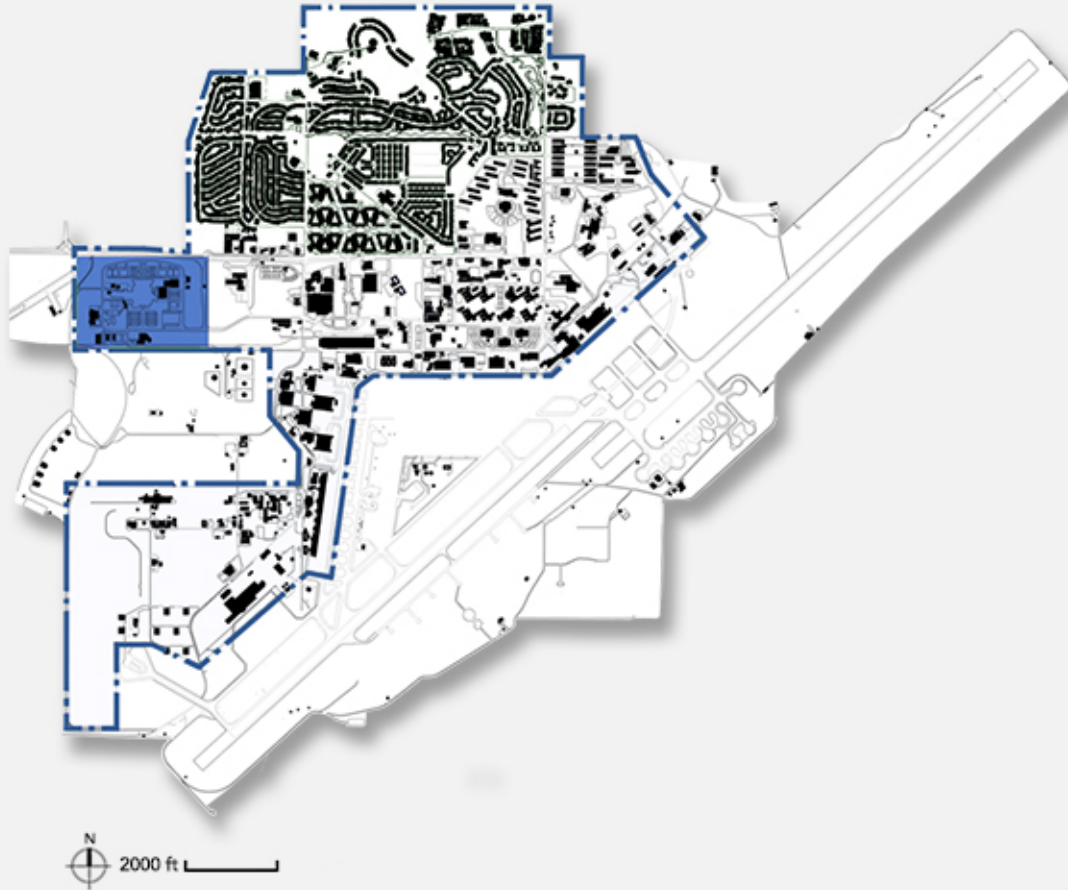

Photos for each facility group within the Facility District as applicable.

Image Tool 250 x 188

Group 1     Applicable     N/A





Group 2    Applicable    N/A



Group 3    Applicable    N/A

Group 4    Applicable    N/A

Other    Applicable    N/A

1. Refer to Item No. 7 above listed under Base-wide Standards.

## G. APPENDIX - References

Comply with Air Force Corporate Standards:

<http://afcs.wbdg.org/index.html>