

(PRE-FINAL) MACDILL AIR FORCE BASE INSTALLATION FACILITY STANDARDS (IFS)



Installation Elements



Site Development



Facilities Exteriors



Facilities Interiors

APPROVED FOR PUBLIC RELEASE; DISTRIBUTION UNLIMITED

Signature Field

MacDill Air Force Base IFS

Table of Contents

A. OVERVIEW	5	B03.2.3. Preserves	
A01. Facility Hierarchy	5	B03.2.4. Perimeter Fence	
A02. Facility Quality	5	C. SITE DEVELOPMENT	23
A03. Facility Districts	5	C01. Site Design	23
B. INSTALLATION ELEMENTS	7	C01.1. Site Design Considerations	23
B01. Comprehensive Planning	7	C01.2. Building Orientation	26
B01.1. Installation Development Plan (IDP)	7	C02. Utilities	27
B01.1.1. IFS Component Plan of IDP		C02.1. Utility Components	27
B01.1.2. Brief History of Base		C03. Parking Areas	28
B01.1.3. Future Development		C03.1. Configurations and Design	29
B02. Street Envelope Standards	9	C03.1.1. Paving and Striping	
B02.1. Hierarchy of Streets	9	C03.1.2. Curbing	
B02.1.1. Arterial Streets		C03.1.3. Internal Islands and Medians	
B02.1.2. Collector Streets		C03.2. Parking Structures	32
B02.1.3. Local Streets		C03.3. Connectivity	32
B02.1.4. Special Routes		C04. Stormwater Management	32
B02.2. Hierarchy of Intersections	14	C04.1. Stormwater Requirements	33
B02.2.1. Arterials		C05. Sidewalks, Bikeways and Trails	33
B02.2.2. Arterial/Collector		C05.1. Circulation and Paving	34
B02.2.3. Collectors		C05.1.1. Ramps and Stairs	
B02.2.4. Special Intersections		C05.1.2. Lighting	
B02.2.5. Street Frontage Requirements		C06. Landscape	36
B02.2.6. Sight Lines		C06.1. Climate-based Materials	37
B02.3. Street Elements	16	C06.1.1. Landscape Design Concept	
B02.3.1. Paving		C06.1.2. Xeriscape Design Principles	
B02.3.2. Curb and Gutter		C06.1.3. Minimizing Water Requirements	
B02.3.3. Utility Service Elements		C06.1.4. Plant Material Selection	
B02.3.4. Traffic Signs		C06.1.5. Water Budgeting (Hydrozones)	
B02.3.5. Street Lighting		C06.1.6. Base Entrance Landscaping	
B02.3.6. Other		C06.1.7. Streetscape Landscaping	
B03. Open Space / Public Space	19	C06.1.8. Pedestrian Circulation Landscaping	
B03.1. Plazas, Monuments and Static Displays	19	C06.1.9. Parking Lot Landscaping	
B03.1.1. Paved Plazas		C06.1.10. Screen/Accent Landscaping	
B03.1.2. Sculptures, Markers and Statuary		C06.1.11. Other	
B03.1.3. Static Display of Aircraft		C07. Site Furnishings	45
B03.2. Grounds and Perimeters	20	C07.1. Furnishings and Elements	45
B03.2.1. Parade Grounds			
B03.2.2. Parks			

Table of contents continued

C07.2. Site Furnishings Products, Materials / Color ..	47	D03.3.4. Thermal Shading	
C07.2.1. Barbeque Grills		D03.3.5. Renewable Heating/Cooling	
C07.2.2. Benches		D03.3.6. Solar Photovoltaic System	
C07.2.3. Bike Racks		D03.3.7. Solar Thermal System	
C07.2.4. Bike Lockers		D04. Building Entrances	76
C07.2.5. Bollards		D04.1. Primary Entrances	77
C07.2.6. Bus Shelters		D04.2. Secondary Entrances	77
C07.2.7. Drinking Fountains		D05. Wall Systems	79
C07.2.8. Dumpster Enclosures / Gates		D05.1. Hierarchy of Materials	80
C07.2.9. Fencing		D05.2. Layout, Organization and Durability	80
C07.2.10. Flagpoles		D05.3. Equipment, Vents and Devices	81
C07.2.11. Lighting – Landscape / Accent		D05.4 Wall Systems Materials	81
C07.2.12. Litter and Ash Receptacles		D05.4.1. Flat Metal Panels	
C07.2.13. Picnic Tables		D05.4.2. Brick Veneer	
C07.2.14. Planters – Free Standing		D05.4.3. Architectural Precast	
C07.2.15. Play Equipment		D05.4.4. Stucco Over Sheathing	
C07.2.16. Screen Walls		D05.4.5. Curtain Wall	
C07.2.17. Tree Grates		D05.4.6. Cast-in Place Concrete	
C07.2.18. Other		D05.4.7. Tilt-up Concrete	
C08. Exterior Signs	54	D05.4.8. Ribbed Metal Sheeting	
C08.1. Colors and Types	55	D05.4.9. EFIS	
C08.1.1. Materials and Color Specifications		D05.4.10. GRFC	
C08.1.2. Installation and Gate Identification Signs		D05.4.11. Concrete Block	
C08.1.3. Building Identification Signs		D05.4.12. Fiber Cement Siding	
C08.1.4. Traffic Control Devices (Street Signs)		D05.4.13. Other	
C08.1.5. Directional and Wayfinding Signs		D06. Doors and Windows	85
C08.1.6. Informational Signs		D06.1. Types	86
C08.1.7. Motivational Signs		D06.2. Layout and Geometry	87
C08.1.8. Parking Lot Signs		D06.3. Glazing and Shading	87
C08.1.9. Regulatory Signs		D06.4. Hardware	87
C08.1.10. Other		D06.5. Doors and Windows Materials	87
C09. Lighting	61	D06.5.1. Anodized Aluminum	
C09.1. Fixtures and Lamping	62	D06.5.2. Hollow Metal	
C09.2. Light Fixture Types	63	D06.5.3. Aluminum-clad Wood	
C09.2.1. Street Lighting		D06.5.4. Other	
C09.2.2. Parking Lot Lighting		D07. Roof Systems	90
C09.2.3. Lighted Bollards		D07.1. Roof Type and Form	91
C09.2.4. Sidewalk Lighting		D07.2. Roof Slope	91
C09.2.5. Walls / Stairs Lighting		D07.3. Parapets and Copings	92
C09.2.6. Other		D07.4. Color and Reflectivity	92
D. FACILITIES EXTERIORS	67	D07.5. Gutters, Downspouts, Scuppers, Drains	92
D01. Supporting the Mission	67	D07.6. Roof Vents and Elements	93
D02. Sustainability	67	D07.7. Clerestories and Skylights	93
D03. Architectural Features	68	D07.8. Vegetated Roof	93
D03.1. Orientation, Massing and Scale	69		
D03.2. Architectural Character	69		
D03.3. Details and Color	71		
D03.3.1. Climate-based Data			
D03.3.2. Natural Ventilation System			
D03.3.3. Thermal Mass			

Table of contents continued

D07.9. Roof Systems Materials	94	E04. Ceilings	113
D07.9.1. Standing Seam Metal		E04.1. Ceiling Materials	113
D07.9.2. Membrane Single-ply		E04.1.1. Exposed Framing (Roof / Floor Structure	
D07.9.3. Built-up Multi-ply		Above)	
D07.9.4. Concrete Tile		E04.1.2. Exposed Concrete	
D07.9.5. Clay Tile		E04.1.3. Grid and Acoustical Tile	
D07.9.6. Slate Shingles		E04.1.4. Gypsum Board	
D07.9.7. Vegetated System		E04.1.5. Metal Panels	
D07.9.8. Ribbed Metal Sheeting		E04.1.6. Wood	
D07.9.9. Composite Shingles		E04.1.7. Rapidly-Renewable Products	
D07.9.10. Other		E04.1.8. Other	
D08. Structural Systems	97	E05. Doors and Windows	116
D08.1. Systems and Layouts	98	E05.1. Doors and Windows and Frames Materials	116
D08.2. Structural Systems Materials	98	E05.1.1. Aluminum	
D08.2.1. Concrete		E05.1.2. Hollow Metal	
D08.2.2. Insulated Concrete Forming (ICF)		E05.1.3. Wood	
D08.2.3. Steel		E05.1.4. Other	
D08.2.4. Pre-Engineered Steel		E06. Casework Systems	120
D08.2.5. Masonry		E06.1. Casework Materials	120
D08.2.6. Heavy Timber		E06.1.1. Plastic Laminate	
D08.2.7. Light-gauge Steel		E06.1.2. Solid Polymer Surface	
D08.2.8. Lumber Framing		E06.1.3. Rapidly-Renewable Products	
D08.2.9. Other		E06.1.4. Metal	
D09. Mechanical, Electrical and Plumbing	101	E06.2. Countertop Materials	122
D09.1. Passive and Active Systems	102	E06.2.1. Plastic Laminate	
D09.2. Functionality and Efficiency	102	E06.2.2. Solid Polymer Surface	
E. FACILITIES INTERIORS	104	E06.2.3. Natural Stone	
E01. Building Configurations	105	E06.2.4. Cast Stone	
E01.1. Layout and Common Areas	105	E06.2.5. Metal	
E01.1.1. Interior Design Process		E07. Furnishings	124
E01.1.2. Codes and Regulations		E07.1. Durability and Serviceability	125
E01.2. Quality and Comfort	107	E07.2. Accessories	125
E02. Floors	107	E08. Interior Signs	125
E02.1. Floor Materials	107	E08.1 Types and Color	125
E02.1.1. Prepared Slabs		E08.2. Interior Signs Materials	125
E02.1.2. Natural Stone and Terrazzo		E09. Lighting, Power and Communication	125
E02.1.3. Quarry Tile		E09.1. Functionality and Efficiency	125
E02.1.4. Ceramic Tile		E09.2. Types and Color	125
E02.1.5. Resilient Floor		F. Appendices	126
E02.1.6. Carpet		G. Appendices	126
E02.1.7. Rapidly-Renewable Products			
E02.1.8. Other			
E03. Walls	111		
E03.1. Wall Materials	111		
E03.1.1. Concrete			
E03.1.2. Masonry			
E03.1.3. Ceramic Tile			
E03.1.4. Gypsum Board			
E03.1.5. Metal Panels			
E03.1.6. Wood Paneling			
E03.1.7. Rapidly-Renewable Products			
E03.1.8. Other			

A. OVERVIEW

Comply with Air Force Corporate Standards for Overview:

<http://afcfs.wbdg.org/index.html>

This Installation Facilities Standards (IFS) document is part of the Air Force Corporate Facilities Standards (AFCFS) program to assist bases in implementing and maintaining facilities standards as appropriate for efficient operations within the respective climate region. IFS fully replaces, consolidates and simplifies existing facilities standards documents, such as the Architectural Compatibility Plan (ACP) or ACGs, FEPs, etc., and organizes information using the same structure, or Table of Contents, as the AFCFS website.

IFS reflects the AFCFS' concepts of "Facility Hierarchy" (categorizing facilities into group numbers) and "Facility Quality" (assigning an appropriate level of quality to each group number) and applies these principles at the base level. Applicable DoD and Air Force criteria such as UFCs, AFIs, Memoranda, and UFGSs (Guide Specs) are referenced and linked within IFS to ensure the document is always current.

Navigating within this IFS is efficient and straightforward. Please use the interactive Table of Contents to locate subject matter, and click on the title of a section to access it. From any page, click on the "Back to Table of Contents" footer to return. Content is organized into 4 major sections: Installation Elements, Site Development, Facilities Exteriors and Facilities Interiors.

This IFS document begins as a fill-in PDF form, which is fully editable, and becomes a "living document" that can be regularly updated by base-level personnel following a format that is consistent across the Air Force. While the format is standardized, IFS content is customized for base operations and the local climate to ensure mission success while emphasizing reduced maintenance and reduced initial costs, life-cycle costs, energy use, and water use.

1. Conformance to Air Force Corporate Facilities Standards (AFCFS) and Installation Facilities Standards (IFS) are required by Air Force Instruction (AFI) 32-1023 and Air Force Memorandum. Please refer to the AFCFS website for links to documentation on current policy.
2. The IFS is a component plan of the Installation Development Plan (IDP) per Air Force Instruction (AFI) 32-7062 (replacing the Architectural Compatibility Plan). All military construction projects and Non-Appropriated Funds (NAF) facilities are required to comply with the IDP and its IFS component plan by AFI 32-1023. The Base Civil Engineer (BCE) maintains and implements the IDP and its component plans, to include the IFS.
3. Please refer to the AFCFS website as a portal to reference materials and requirements documents for design and construction projects (via links). Specific references to current DoD memoranda and Air Force criteria are updated periodically to provide the most current guidance and requirements. Programming, design and contract documents should list "current edition" for all reference and requirements documents. The documents in force at the date of execution of the design and/or construction contract shall be the governing version.
4. *Advanced Modeling Requirements:*
For all Air Force projects requiring advanced modeling, to include 3D visualization, Building Information Modeling (BIM), facility data, quantity take-off, geospatial, etc., follow the Army standards. Refer to USACE Minimum Model Matrix (M3) and Project Execution Plan (PxP) which outline required model uses. Refer to [CAD BIM Technology Center \(Contract Requirements\)](#) for more information on M3 and PxP.
5. Joint Bases shall implement IFS under their Joint-Base designation with volume numbers for individual installations following the IFS Development Tool template. For example, for Joint Base Langley-Eustis, provide: Vol. 1 Langley AFB and Vol. 2 Fort Eustis.

A.01. FACILITY HIERARCHY

Comply with AF Corporate Standards for Facility Hierarchy (and subsections):

<http://afcfs.wbdg.org/facility-hierarchy/index.html>

A.02. FACILITY QUALITY

Comply with AF Corporate Standards for Facility Quality (and subsections):

<http://afcfs.wbdg.org/facility-quality/index.html>

A.03. FACILITY DISTRICTS

Comply with AF Corporate Standards for Facility Districts (and subsections):

<http://afcfs.wbdg.org/facility-districts/index.html>

Image Tool 800 x 800

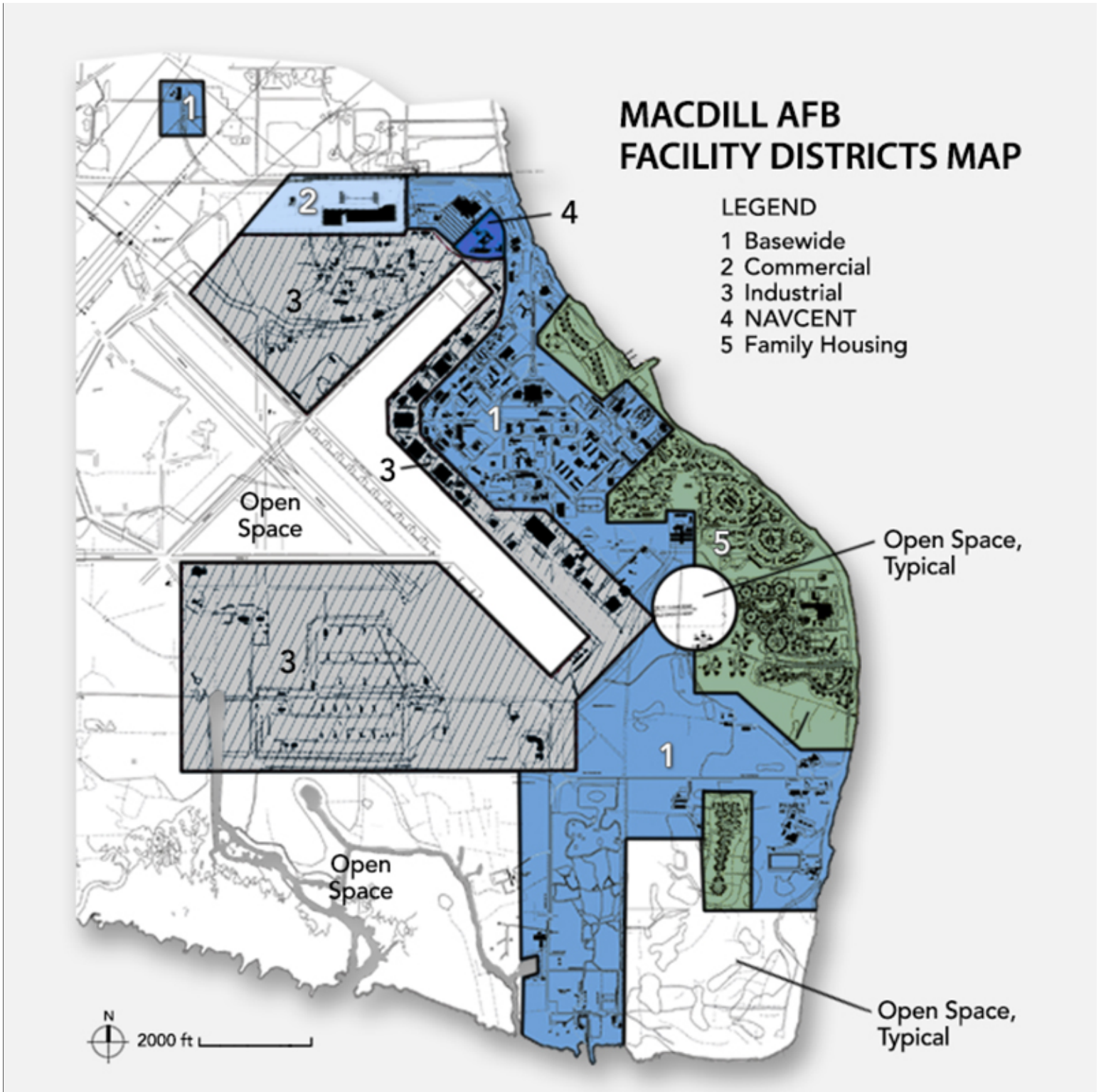

Note: Apply the base-wide standards in this IFS for Installation Elements, Site Development, Facilities Exteriors and Facilities Interiors (products, materials, color, etc.). Following application of the base-wide standards, refer to the Appendix and apply any additional requirements specifically related to the Facility District.

B. INSTALLATION ELEMENTS

Comply with Air Force Corporate Standards for Installation Elements:
<http://afcs.wbdg.org/installation-elements/index.html>

B.01. COMPREHENSIVE PLANNING

Comply with Air Force Corporate Standards for Comprehensive Planning:
<http://afcs.wbdg.org/installation-elements/comprehensive-planning/index.html>

B01.1. Installation Development Plan (IDP)

Applicable N/A Select number of graphics / images (large: 800 px x 440 px) to insert 1

Image Tool 800 x 440

Applicable N/A Small graphics do not apply

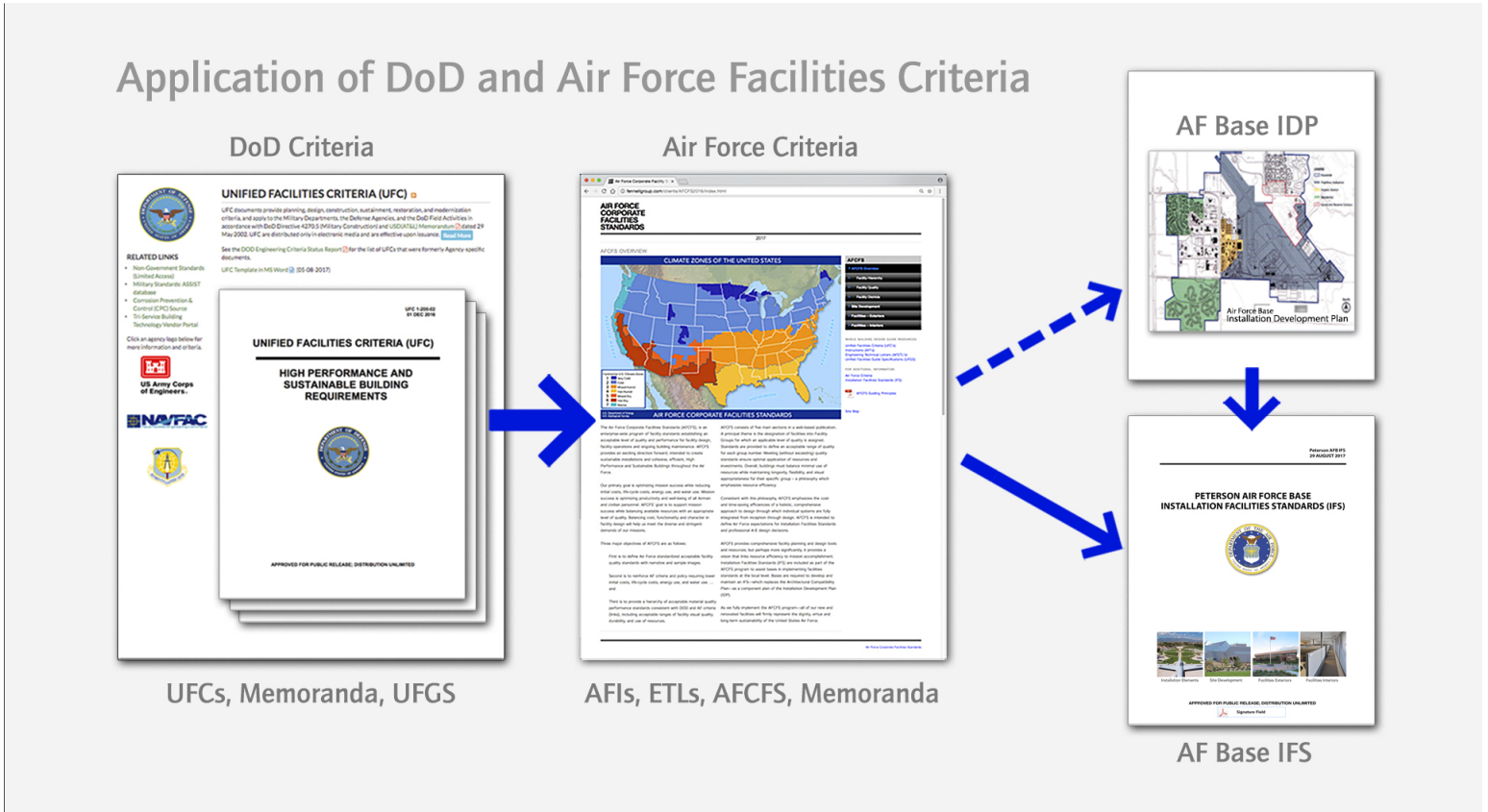

Department of Defense, Department of the Air Force and Air Force Base Criteria

1. The Base Civil Engineer is responsible for developing, maintaining and implementing the installation's Comprehensive Planning documents and to ensure that the Installation Development Plan (IDP) complies with AFI 32-7062.

B01.1.1. IFS Component Plan of IDP

Applicable N/A Large graphics do not apply

Applicable N/A Small graphics do not apply

1. Maintain this Installation Facilities Standards (IFS) as a Component Plan of the base's Installation Development Plan (IDP).

B01.1.2. Brief History of Base

Applicable N/A Large graphics do not apply

Applicable N/A Select number of graphics / images (small: 250 px x 188 px) to insert 3

Image Tool 250 x 188



Bomber Aircraft at MacDill Field



Col. Leslie MacDill



MacDill Field

MacDill Air Force Base is located seven miles south of Tampa, Florida, on the southwestern tip of the interbay peninsula in Hillsborough County. This area once had been used as a military staging area during the Spanish-American War but did not become a military installation until much later. In 1939, the War Department selected Tampa to receive one of several new military air fields and worked out arrangements for the transfer of the land. MacDill Field was officially activated on April 16, 1941, and named in honor of U.S. Army aviation pioneer and World War I veteran, Colonel Leslie MacDill. The first primary mission of the base during World War II involved training Airmen to fly and operate bomber aircraft - such as the B-17 "Flying Fortress" or the B-26 "Marauder." From 1942-45, many thousands of American men passed through MacDill's gates to train as bomber pilots or crew members and then quickly moved on to other military assignments, eventually destined for the deadly fight raging over Europe's skies. Following the end of hostilities in Europe, MacDill began to train crews of the B-29 "Superfortress" in January 1945, which lasted through 1953.

In January 1948, MacDill Air Force Base became an operational base for Strategic Air Command, and activities focused on training in the bombers of the early Cold War era. However, by 1960, the base faced an uncertain future. The Department of Defense announced it would close most of it by 1962 - due in part to the advent of the "missile age" that de-emphasized the bombers. However, hostilities with Cuba in the early 1960s highlighted the strategic location of the base and led to a reprieve of the planned cutbacks. During this time, MacDill assumed another important role providing support for a prominent unified command, U.S. Strike Command, assigned to the base in 1961.

In 1963, the bombers gave way to the fighters when MacDill became a Tactical Air Command training base. Throughout the Vietnam War and up until the first Gulf War in 1991, Tampa became a home for the F-4 "Phantoms" and later the F-16 "Fighting Falcons." Between 1979 and 1993 approximately half of all F-16 pilots trained at MacDill.

The 6th Wing (1994 - Present)

In 1991, the era of the fighters at MacDill began to wane. Due to military downsizing, the Defense Base Closure and Realignment Commission required the base to cease all flying operations by 1993. The action effectively transferred more than 100 F-16 fighters to Luke AFB, Arizona. When the last F-16s left the base in 1994, MacDill AFB had no active duty aircraft for the first time. In 1994, MacDill became home to the 6th Air Base Wing. This new wing had a primary mission of operating the base in support of U.S. Central Command, U.S. Special Operations Command, and a large number of other mission partners and tenant units. However, this mission would grow. In 1994, MacDill played a prominent role in U.S. operations to restore Haitian President Jean-Bertrand Aristide and his government after an attempted military coup. With operations in Haiti highlighting MacDill's significance in the region, the 1995 Defense Base Closure and Realignment Commission recommended to retain the airfield under Air Force control. Eventually, this led to MacDill's new mission in refueling.

In 2008, the base wing experienced more changes as part of a major restructuring by the Air Force. This time, MacDill and the 6th welcomed the Air Force Reserve's 927th Air Refueling Wing as a joint partner in the aerial refueling mission at MacDill. Currently, these two units - one active duty and the other reserve - work together using the same KC-135 "Stratotankers" to more efficiently carry out the Air Force's missions. Today at MacDill, the 6th Air Mobility Wing performs aerial refueling, airlift, and contingency response missions for U.S. and allied forces around the world. The wing has sixteen KC-135 "Stratotankers," three C-37A aircraft,

and more than 2,700 personnel assigned. Additionally, the 6th Air Mobility Wing is the host unit of MacDill Air Force Base and provides direct support to U.S. Central Command, U.S. Special Operations Command, and 39 other tenant units.

B01.1.3. Future Development

Applicable N/A Large graphics do not apply

Applicable N/A Small graphics do not apply

1. Follow AFI 32-7062 for Air Force Comprehensive Planning, the Comprehensive Planning Process, Comprehensive Planning Requirements, and Geospatial Mapping.
2. Address all future development under the Installation Development Plan (IDP).

B02. STREET ENVELOPE STANDARDS

Comply with Air Force Corporate Standards for Installation Elements:

<http://afcs.wbdg.org/installation-elements/index.html>

Comply with AF Corporate Standards for Street Envelope Standards:

<http://afcs.wbdg.org/installation-elements/street-envelope-standards/index.html>

B02.1. Hierarchy of Streets

Applicable N/A Select number of graphics / images (large: 800 px x 440 px) to insert 1

Image Tool 800 x 440

Applicable N/A Select number of graphics / images (small: 250 px x 188 px) to insert 2

Image Tool 250 x 188

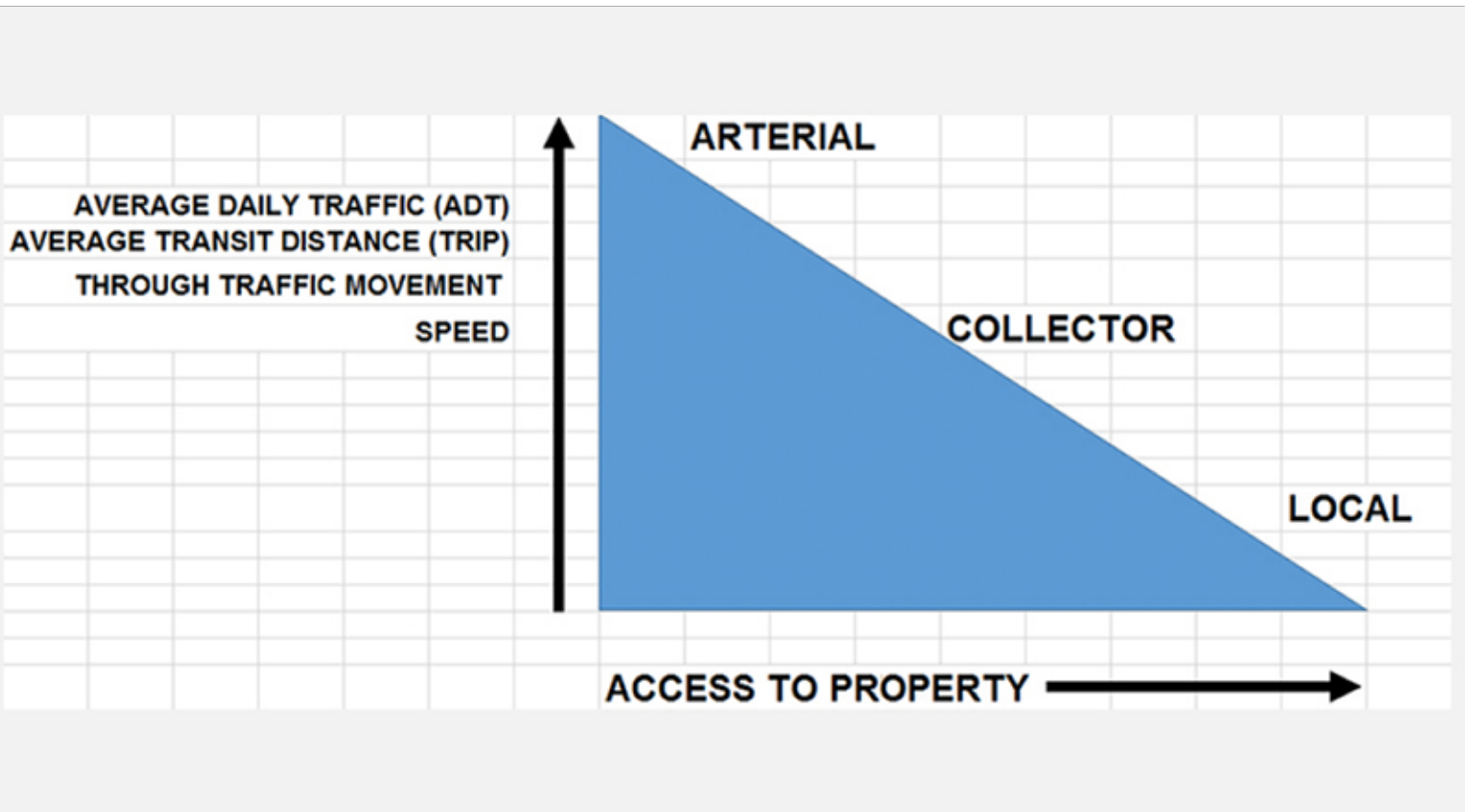

Traffic Volume / Property Access Diagram



Adjoining Group 4 Facilities



Contiguous Group 3 Facilities

1. Develop and evolve a hierarchical transportation network of arterial, collector and local streets following UFC 3-201-01 and its industry references.
2. Provide consistent functionality throughout the installation and a level of visual quality relating to the adjacent Facility Group number that is clean, neat and orderly.
3. Routes along facilities in Group 1 may have materials, finishes and features with a higher visual quality than Groups 2, 3 and 4. Reduce maintenance requirements by installing highly durable materials and finishes in routes along Group 3 industrial facilities.
4. Special routes may have a visual quality comparable to those along facilities in Group 1.
5. Create and maintain arterials with two lanes of traffic in each direction with landscaped or paved medians as applicable to the local climate and adjacent facility group designation / land use.
6. Minimize stops and turns along arterials. Eliminate on-street parking along arterials and collector streets.
7. Connect arterials to local streets with appropriately scaled collector streets.
8. Provide appropriate landscape setbacks and pedestrian buffers along all streets.
9. Minimize and consolidate curb cuts along streets.
10. Ensure access for emergency and service vehicles.
11. Define bicycle traffic routes in the Installation Development Plan or its applicable component plans.
12. Provide illustrations in the Installation Facilities Standards (IFS) to include street cross-sections and plans for every type of street specified on the installation. At a minimum provide dimensions for vehicular traffic-lanes, curb radii, medians, bike lanes, pedestrian buffers, sidewalks, crosswalks, tree planting areas, and on-street parking configurations.
13. Define appropriate force protection features, site furnishings, signs, lighting, utilities, and paving in the IFS.

B02.1.1. Arterial Streets

Applicable N/A Select number of graphics / images (large: 800 px x 440 px) to insert 1

Image Tool 800 x 440

Applicable N/A Small graphics do not apply

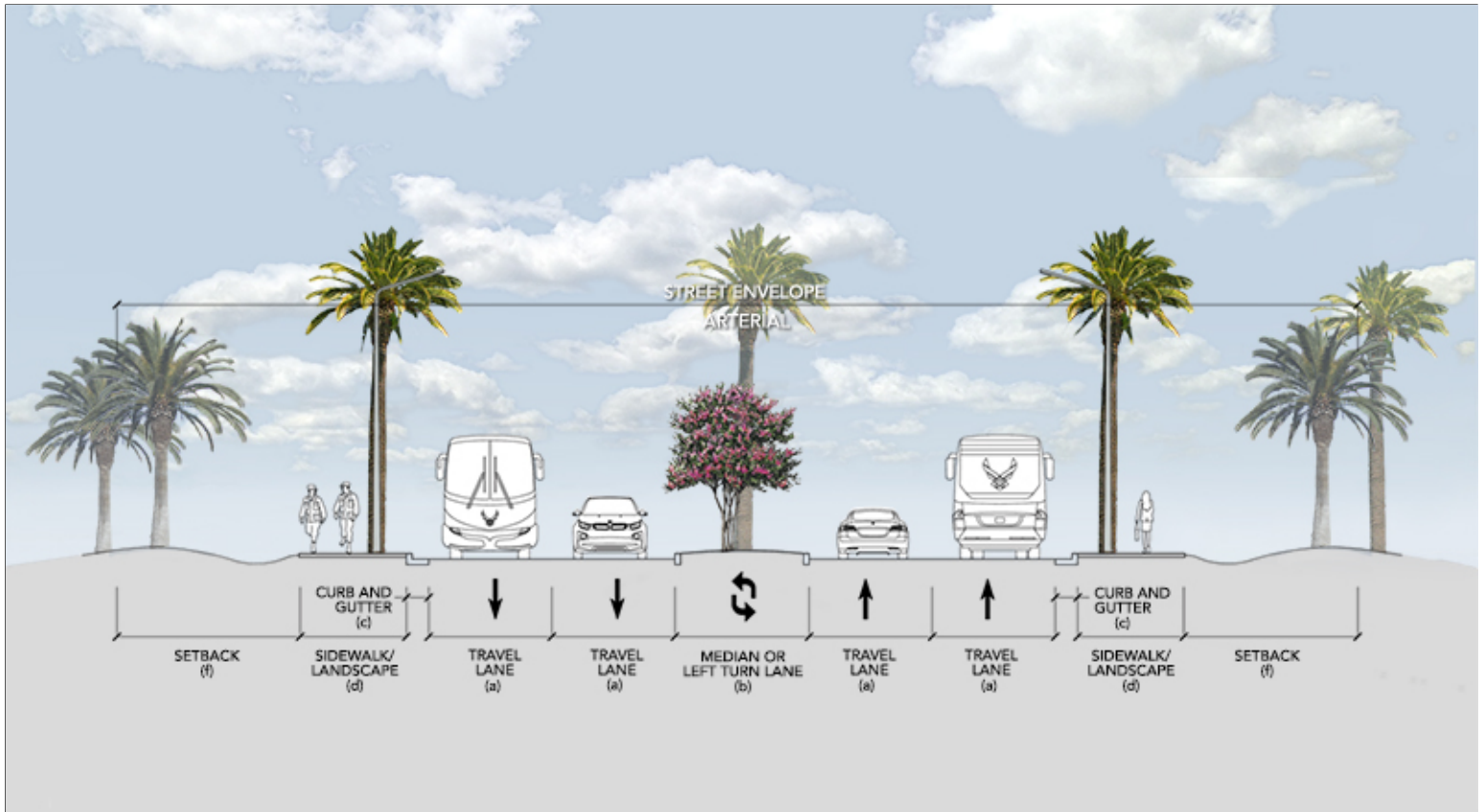

Travel Lane (a): 12' Median (b): 12' Curb and Gutter (c): 2' Sidewalk / Landscape (d): 12' Setback (f): 30' or per ATFP

1. Stops and turns should be minimized and on-street parking shall not be allowed at any point along arterial streets.
2. Provide sidewalks on at least one side of arterial streets and both sides of arterial streets in developed areas. Provide a 6 foot buffer between the road and sidewalk where space allows.
3. Limit curb cuts on arterial streets to entries into major facilities, building groups and major parking areas.
4. Signs, plantings and street lighting should be added to reinforce the importance of arterial streets.

B02.1.2. Collector Streets

Applicable N/A Select number of graphics / images (large: 800 px x 440 px) to insert 1

Image Tool 800 x 440

Applicable N/A Small graphics do not apply

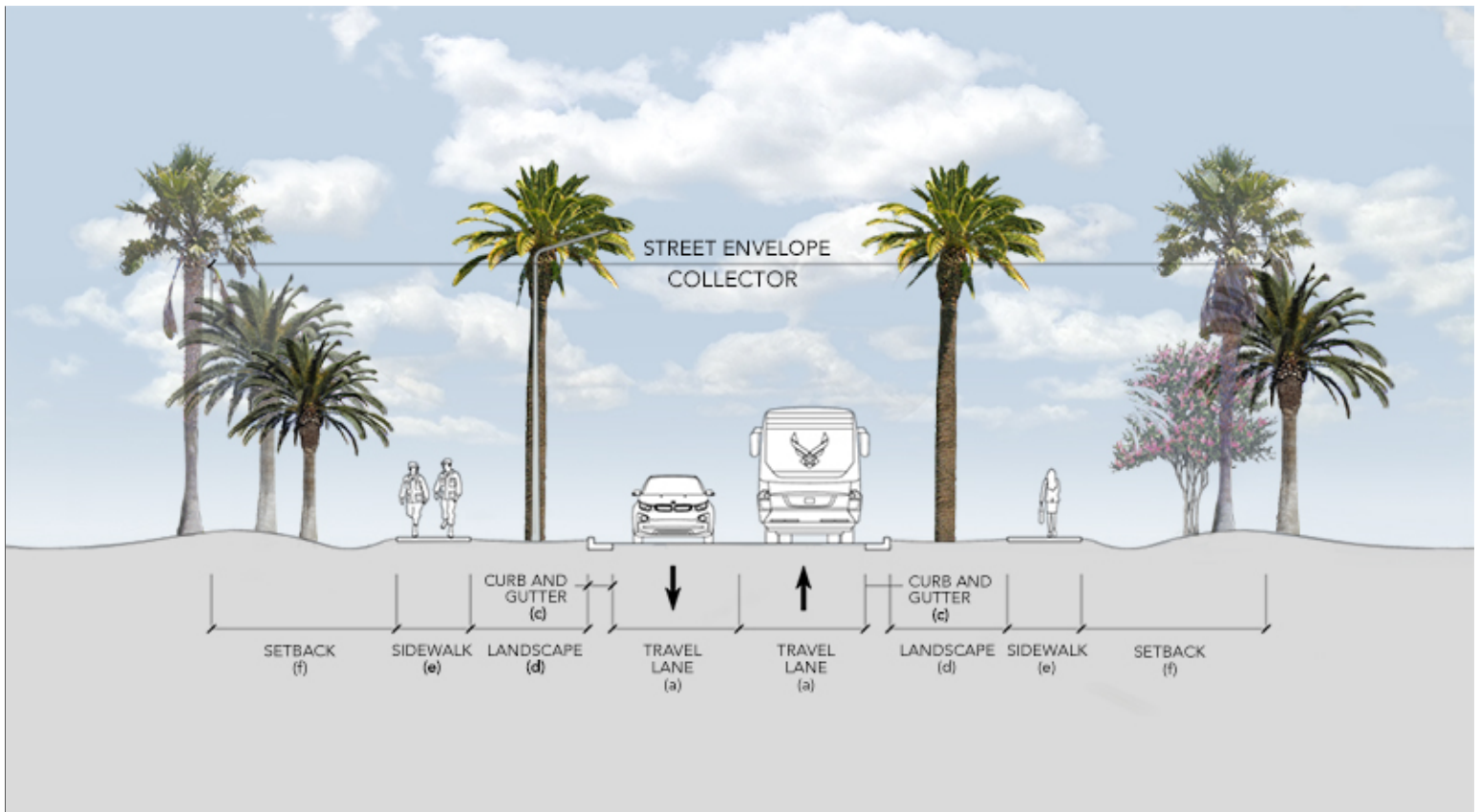

Travel Lane (a): 12' Median (b): N/A Curb and Gutter (c): 2' Landscape (d): 10' Sidewalk (e): 6' Setback (f): 15' or per ATFP

1. Design collector streets to be less prominent than arterials.
2. Match the level of quality of street elements to the adjacent Facility Group number.

B02.1.3. Local Streets

Applicable N/A Select number of graphics / images (large: 800 px x 440 px) to insert 1

Image Tool 800 x 440

Applicable N/A Select number of graphics / images (small: 250 px x 188 px) to insert 1

Image Tool 250 x 188

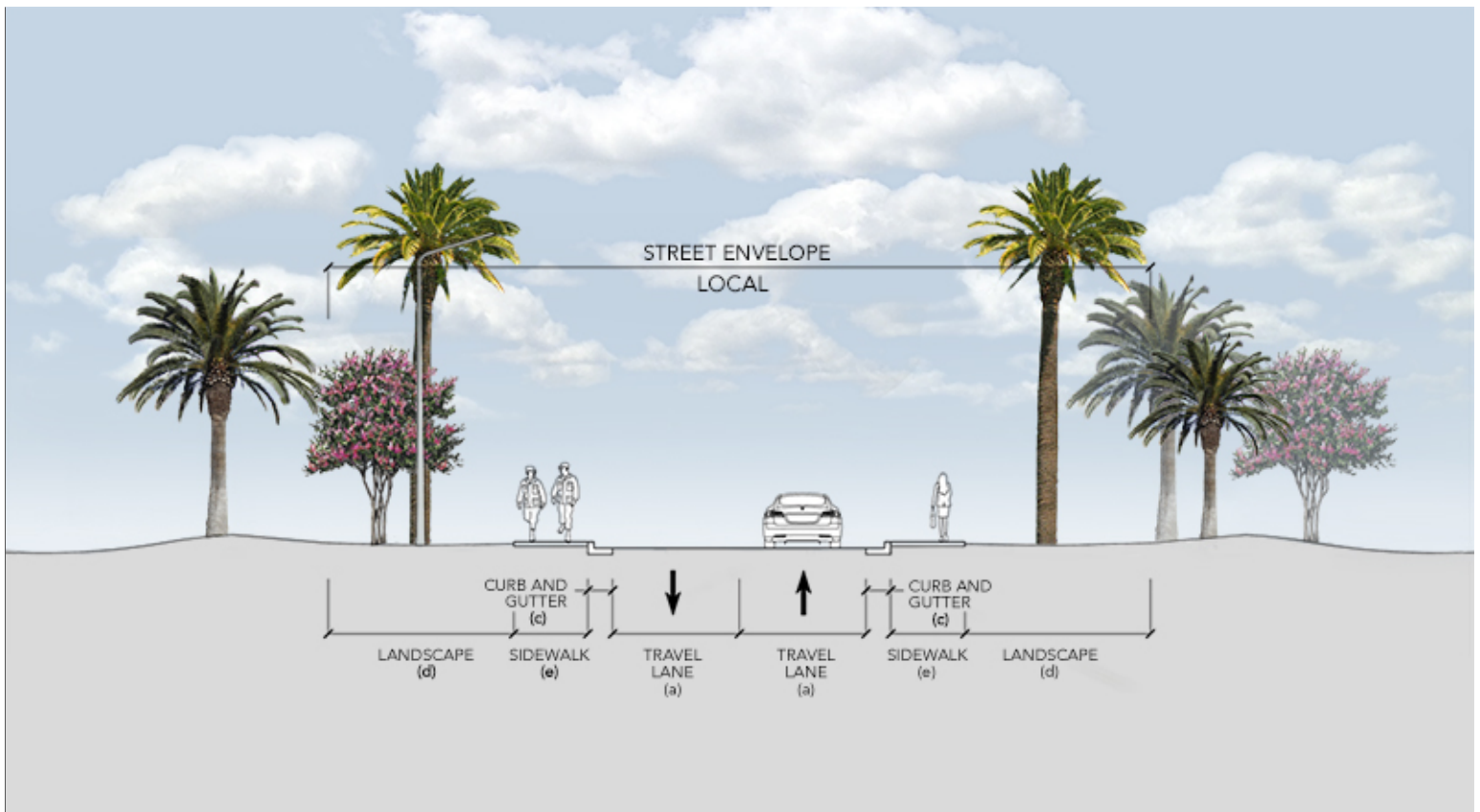

Travel Lane (a): 11' Median (b): N/A Curb and Gutter (c): 1.5' Landscape (d): 15' Sidewalk (e): 6' Setback (f): 15' or per ATFP



Local Street with Detached Sidewalks

1. Design and maintain local streets in due proportion to the amount of traffic.
2. Generally encourage the development of street frontage of adjacent sites to positively contribute features such as landscaping.
3. Maintain consistent local streetscapes for visual and functional continuity.

B02.1.4. Special Routes

Applicable N/A Large graphics do not apply

Applicable N/A Select number of graphics / images (small: 250 px x 188 px) to insert 1

Image Tool 250 x 188



Historic District Route

1. Develop all special routes consistently with those adjacent to Group 1 facilities.

B02.2. Hierarchy of Intersections

Applicable N/A Large graphics do not apply

Applicable N/A Select number of graphics / images (small: 250 px x 188 px) to insert 2

Image Tool 250 x 188



Crosswalk at Intersection



Intersection in Housing Area

1. Provide a hierarchy of intersections to include arterial, arterial-collector, collector, collector-local and local following UFC 3-201-01 and its industry references.
2. Passive systems such as traffic circles are preferred to active systems such as signalized intersections. Aggressively pursue passive systems to lower maintenance requirements and reduce energy use.
3. Use a level of visual quality for an intersection equal to the quality found in the related streetscape, which corresponds to the adjacent Facility Group number.

B02.2.1. Arterials

Applicable N/A Large graphics do not apply

Applicable N/A Small graphics do not apply

1. Refer to UFC 2-100-01 Installation Master Planning for guidance on arterial streetscape design.

B02.2.2. Arterial/Collector

Applicable N/A Large graphics do not apply

Applicable N/A Small graphics do not apply

1. Refer to UFC 2-100-01 Installation Master Planning for guidance on arterial streetscape design.

B02.2.3. Collectors

Applicable N/A Large graphics do not apply

Applicable N/A Small graphics do not apply

1. Refer to UFC 2-100-01 Installation Master Planning for guidance on arterial streetscape design.

B02.2.4. Special Intersections

Applicable N/A Large graphics do not apply

Applicable N/A Small graphics do not apply

1. Develop all special intersections consistently with those adjacent to Group 1 facilities.

B02.2.5. Street Frontage Requirements

Applicable N/A Large graphics do not apply

Applicable N/A Small graphics do not apply

1. Consistently maintain open space buffers following B03.2.3. Preserves.
2. Refer to C06.1.7. Streetscape Landscaping for planting and screen wall requirements along street frontage.
3. Refer to UFC 4-010-01 DoD Minimum Antiterrorism Standards for Buildings, with Change 1 and UFC 4-010-02 DoD Minimum Antiterrorism Standoff Distances for Buildings (FOUO) for street frontage requirements.

B02.2.6. Sight Lines

Applicable N/A Large graphics do not apply

Applicable N/A Small graphics do not apply

1. Provide adequate sight lines for an effective and safe traffic operation per American Association of State Highway and Transportation Officials (AASHTO) standards and local municipality guidelines.
2. Sight lines will vary based on the speed and classification of the roadway or intersection.

B02.3. Street Elements

Applicable N/A Large graphics do not apply

Applicable N/A Select number of graphics / images (small: 250 px x 188 px) to insert 1

Image Tool 250 x 188



Detached Sidewalk

1. Emulate the streetscape area's pre-development hydrology using passive and active design features to help sustain the adjacent regionally appropriate landscape. Coordinate with the base Stormwater Management Plan.
2. Employ systems, materials and techniques to maximize streetscape sustainability. Consider pervious paving and reflectivity of surfaces appropriate for the local climate.
3. Install at-grade curbing and/or raised-profile curb and gutter as applicable to direct stormwater to bioswales and rain gardens as source water for vegetation. Do not paint concrete curbing.
4. All Electrical Services to buildings and facilities shall be underground. All new or improved base electrical distribution shall be underground. Aboveground Electrical Power is not permitted.
5. For non-electrical on-site utility service lines and equipment shall be below grade when adjacent to Facility Group 1. In routes along Group 2, 3, and 4, when mounting elements such as utility cabinets, communications equipment, water valves, et cetera, if above grade is unavoidable then paint these consistently and provide visual screening following Installation Facilities Standards (IFS).
5. Provide traffic control devices including access control point/entry control facility signs, speed limit signs and street name signs following the current edition of the Manual on Uniform Traffic Control Devices (MUTCD) per UFC 3-120-01.
6. Follow UFC 3-120-01 for directional and wayfinding signs and address both vehicular and pedestrian traffic.
7. Reduce energy consumption and reduce maintenance requirements by providing street lighting only when functionally required to ensure safety and to address antiterrorism following UFC 4-010-01. Ensure the quality and quantities of lighting and fixtures are appropriate for the adjacent Facility Group number.

B02.3.1. Paving

Applicable N/A Large graphics do not apply

Applicable N/A Small graphics do not apply

1. Pavement design shall comply with UFC 3-250-01. Ensure appropriate analysis and design of subgrade conditions to support low maintenance high performance pavements.
2. Materials for pavements shall be specified in accordance with UFC 3-250-01 and must conform to requirements set forth in the Unified Facility Guide Specifications (UFGS) for concrete and asphaltic concrete.

B02.3.2. Curb and Gutter

Applicable N/A Large graphics do not apply

Applicable N/A Select number of graphics / images (small: 250 px x 188 px) to insert 4

Image Tool 250 x 188

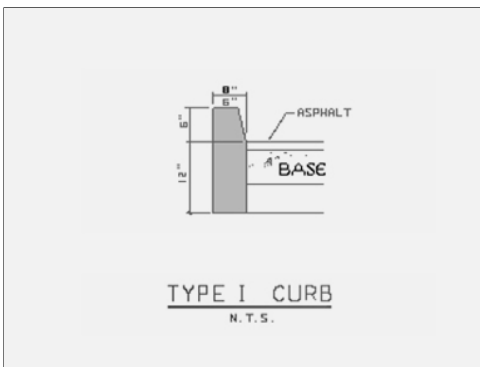

Type 1 Header Curb

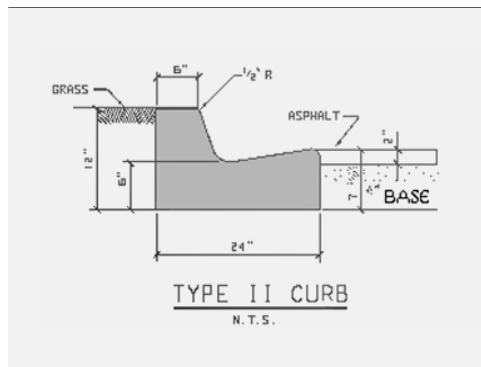

Type 2 Integral Curb and Gutter

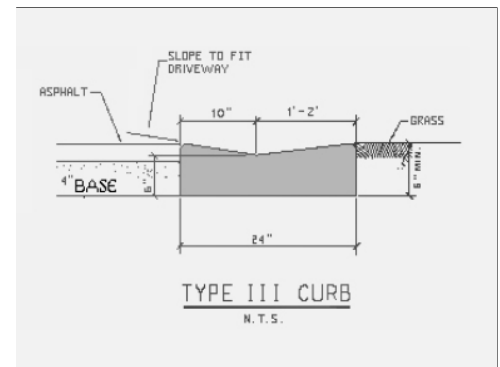

Type 3 Drainage Pan

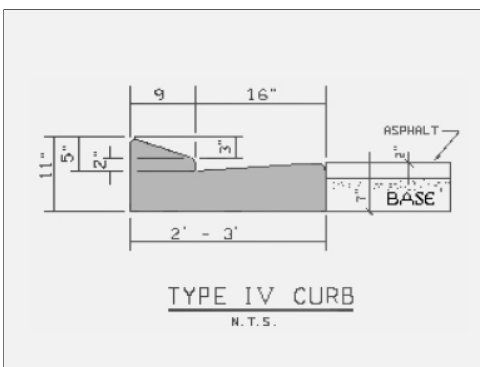

Type 4 Mountable Curb

1. Continuous concrete curbs and gutters shall be provided at street edges areas of the installation to:
 - Help control drainage
 - Deter vehicles from leaving the pavement
 - Protect pedestrians
 - Delineate the pavement edge
 - Present a more finished general appearance
 - Assist in orderly and disciplined development of the street system

2. Provide dimensions following the illustrations for Standard Mountable Curb, Standard Barrier Curb and Standard Header Curb.
3. Use the barrier curb design at arterial streets and at raised central medians. Use the mountable curb design at collector and local streets. Use the header curb design at locations where a permanent, finished edge is required, but where pavement drainage can flow onto adjacent areas such as bioswales and rain gardens.

B02.3.3. Utility Service Elements

Applicable N/A Large graphics do not apply

Applicable N/A Small graphics do not apply

1. Provide all utility service lines below grade when streets are adjacent to Facility Group 1; when mounting elements (such as utility cabinets, communications equipment and water valves) above grade is unavoidable, paint these consistently and provide visual screening following Site Development, Landscaping.
2. Overhead service lines along streets adjacent to Facility Groups 2, 3 and 4 are discouraged.

B02.3.4. Traffic Signs

Applicable N/A Large graphics do not apply

Applicable N/A Small graphics do not apply

1. Refer to Exterior Signs, Colors, and Types for Traffic Control Devices, which includes signs.

B02.3.5. Street Lighting

Applicable N/A Large graphics do not apply

Applicable N/A Small graphics do not apply

1. Refer to the Lighting section for appropriate applications along streets.

B02.3.6. Other

Applicable N/A Large graphics do not apply

Applicable N/A Small graphics do not apply

B03. OPEN SPACE / PUBLIC SPACE

Comply with Air Force Corporate Standards for Installation Elements:

<http://afcs.wbdg.org/installation-elements/index.html>

Comply with AF Corporate Standards for Open Space / Public Space:

<http://afcs.wbdg.org/installation-elements/open-space-public-space/index.html>

B03.1. Plazas, Monuments and Static Displays

Applicable N/A Large graphics do not apply

Applicable N/A Select number of graphics / images (small: 250 px x 188 px) to insert 2

Image Tool 250 x 188



Sustainable Water Feature



Ceremonial Plaza

1. Natural features and culturally or historically significant features or events may be recognized and acknowledged with physical elements such as plazas, monuments and static displays. However, limit these elements on the base to ensure judicious use of resources and to reduce ongoing maintenance requirements.
2. Design highly durable plazas, monuments and static displays with a level of quality comparable to Facility Group 1.
3. Link plazas, monuments and static displays to the pedestrian circulation system. Install landscaping, site furnishings and lighting appropriate for the application and local climate following Installation Facilities Standards (IFS).
4. Select systems, products and materials for paving, walls, and structures following IFS.

B03.1.1. Paved Plazas

Applicable N/A Large graphics do not apply

Applicable N/A Small graphics do not apply

1. Mitigate heat island by providing high-albedo, shaded plazas. Pervious pavers shall be used on all plazas and courtyards in Facility Groups 1 and 2; use pervious concrete in Groups 3 and 4. The designer shall incorporate appropriate expansion and construction joints.
2. Pavers shall match the color of pavers used on adjacent sidewalks using base standard range of light beige. Bricks used on plazas shall typically be 4" x 8" size.

B03.1.2. Sculptures, Markers and Statuary

Applicable N/A Large graphics do not apply

Applicable N/A Small graphics do not apply

1. Relate new sculpture, markers and statuary to the base's architectural design theme. Generally limit these elements to frequently used locations adjacent to Facility Group 1 and highly traveled community pedestrian spaces.
2. Consider entry gates as possible sites for new displays.
3. All proposed memorials shall follow AFI 36-3108 and be limited to highly deserving individuals or groups as deemed appropriate by the installation leadership. Living memorials (tree plantings / etc.) are discouraged due to added maintenance requirements.
4. When sculpture requires a base, match the materials and / or color palette of adjacent buildings.
5. Use direct or indirect lighting to accentuate features or enhance an intended effect.
6. Ensure that all sculpture, markers and statuary are honorable and inspiring, provide a sense of place, positively contribute to the base's visual quality, and encourage pride for the community and the US Air Force.

B03.1.3. Static Display of Aircraft

Applicable N/A Large graphics do not apply

Applicable N/A Small graphics do not apply

1. Follow IFS base-wide standards for all elements of the display area with specific attention to traffic sight lines, pedestrian circulation, site furnishings, signs, and lighting. Address requirements for the Facility District as well.

B03.2. Grounds and Perimeters

Applicable N/A Large graphics do not apply

Applicable N/A Select number of graphics / images (small: 250 px x 188 px) to insert 2

Image Tool 250 x 188



Open Space Buffer



Preservation Area

1. Provide formal spaces for parade and review functions, recreational areas and parks following the base's Installation Development Plan (IDP) and Installation Facilities Standards (IFS). Refer to the Site Furnishings topic for additional information.

2. Maintain preservation areas following the IDP and IFS.
3. Comply with UFC 4-010-01 DoD Minimum Antiterrorism Standards for Buildings and UFC 4-022-03 Security Fences and Gates for all elements associated with the base's gates and perimeter fence.
4. Identify and describe base-wide utility corridors in the IDP.
5. Base-wide utility infrastructure shall be inconspicuous. Bury utility service lines below grade when adjacent to Facility Group 1 and when economically feasible for Facility Groups 2, 3 and 4. When service lines are located above grade, create an ordered, coordinated appearance.
6. Follow the requirements of this IFS regarding all utility structures and service lines located above grade that visually impact the installation.
7. Where screening of utility equipment and structures is provided, allow adequate and proper clearance for safety and maintenance.
8. Reduce visual clutter and visual impact of the following items through a combination of careful placement, screen walls, landscaping and painting:
 - Electrical switch-stations.
 - Sewage lift stations.
 - Water well pumps, storage tanks and/or related structures.
 - Gas piping, meters and similar incidental items.
 - Above ground fuel storage tanks.
 - Any ground-mounted freestanding utility item exposed to view.
9. Larger structures such as electrical switch-stations, sewage lift stations, fuel storage tanks and mechanical/electrical equipment shall be screened from view, using materials, forms, and colors in the screen walls which match those respective design elements present at adjacent buildings.
10. Paint above-ground equipment and associated components such as electrical piping or exposed plumbing lines dark bronze.
11. Maintain currently buried utility service lines as a visual asset.
12. Bury the following exposed above-grade items in future projects when economically feasible:
 - Electrical power grid and service lines.
 - Telephone lines.
 - Cable TV lines.
 - Communications lines.
 - Exterior lighting service lines.
 - Any similar system of above-ground lines serving the base.
13. Consolidate and enclose service utility lines in underground utility corridors when feasible. Create routes along the inside edge of parking lot islands.

B03.2.1. Parade Grounds

Applicable N/A Large graphics do not apply

Applicable N/A Small graphics do not apply

1. Follow UFC 3-201-02, Appendix B for the planning and design process and criteria for parade grounds.
2. Establish and maintain parade grounds only where there is a confirmed need and provide landscape materials appropriate for the locale following IFS.

3. Bleachers may be installed only when there is a documented requirement at parade grounds. Nonferrous metals that do not require painting or going maintenance are preferred. The Base Civil Engineer shall determine quantities, sizes, and products on a case basis.

B03.2.2. Parks

Applicable N/A Large graphics do not apply

Applicable N/A Small graphics do not apply

1. Bleachers may be installed only when there is a documented requirement at parks and fields for recreational events. Follow guidance under Parade Grounds.
2. Picnic pavilions may be provided in parks where there is a documented need.

B03.2.3. Preserves

Applicable N/A Large graphics do not apply

Applicable N/A Small graphics do not apply

1. Preserve areas adjacent to runways, taxiways, aprons, golf course roughs, storage areas, antenna facilities, and ammunition storage areas, as open space.
2. Provide minimal maintenance with mowing as needed for controlling bird behavior for airfield safety, or eliminating fire hazards.

B03.2.4. Perimeter Fence

Applicable N/A Large graphics do not apply

Applicable N/A Small graphics do not apply

1. Design, install and maintain the base's perimeter fence following UFC 4-022-03.
2. Stringently comply with AT / FP requirements following UFC 04-010-01 for all spaces adjacent to the base's perimeter fence and all gates.
3. Fencing, gates and other elements that are associated with the main gates shall be a level of quality equivalent to Facility Group 1.
4. Maintain a positive visual quality along the traffic corridor on both sides of the main gates. Specifically address pedestrian access, circulation and common areas.

C. SITE DEVELOPMENT

Comply with Air Force Corporate Standards for Site Development:
<http://afcs.wbdg.org/site-development/index.html>

C01. SITE DESIGN

Comply with Air Force Corporate Standards for Site Development:
<http://afcs.wbdg.org/site-development/index.html>

Comply with AF Corporate Standards for Site Design / NEPA:
<http://afcs.wbdg.org/site-development/site-design-nepa/index.html>

C01.1. Site Design Considerations

Applicable N/A Select number of graphics / images (large: 800 px x 440 px) to insert 1

Image Tool 800 x 440

Applicable N/A Select number of graphics / images (small: 250 px x 188 px) to insert 6

Image Tool 250 x 188



Topography Promoting Drainage to Retention Pond



Alignment with Entrance



Pedestrian Access



Open Space Buffer

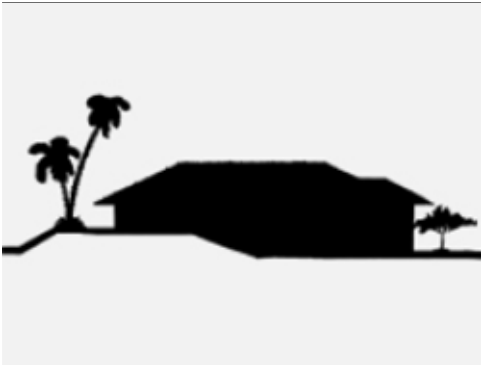

Contouring Landforms

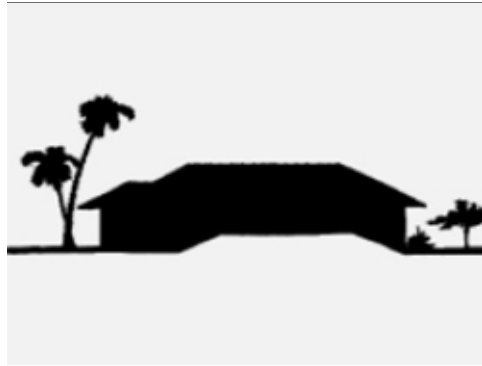

Integrate with Landforms



Road Setback

1. Collect documentation to validate approvals and completion of the NEPA process.
2. Ensure site design compliance with the Installation Development Plan (IDP) and its component plans and Installation Facilities Standards (IFS).
3. Promote integrated design with on-site solutions such as engineered small-scale hydrologic controls versus base-wide infrastructure; consider open space, natural features, bioswales, building roofs, streets, and paved surfaces.
4. Limit the impact of development on land and water resources. All site elements and infrastructure shall reinforce an image of sustainability, with reduced energy demand, renewable-energy usage, and water conservation.
5. Consider energy conservation during site design for the following categories: building and site lighting, auxiliary systems and equipment (refrigerators, elevators, etc.), building envelope, electric power and distribution, HVAC systems and equipment, service hot water, energy management (metering, EMCS).
6. Address the relationship of new facilities to existing facilities. Maintain continuity in the development of street frontage and ensure architectural compatibility in building configurations. Include open space, vistas, and the relationship between buildings and the ground plane in the site design process.
7. Coordinate on-site renewable-energy systems and components to minimize area requirements and maximize efficiencies. Appropriately buffer and screen these and other mechanical systems and equipment.
8. New building projects should preserve open space and protect natural habitat.
9. Carefully study new project sites to identify the character of adjacent buildings, streets, landscaping, and site design elements. Reinforce the existing character in new site design.
10. Consider relationships to adjacent facilities and district / centralized heating and cooling infrastructure and cost effectively connect building systems to harvest heat, grey water or other beneficial byproducts.

11. Minimize existing and planned obstructions from landscaping, structures, topography, and adjacent developments to preserve solar access and natural ventilation.
12. Purposefully integrate service access, receiving and storage areas to eliminate the need for visual screening.
13. Appropriately connect to the base network of streets, sidewalks and trails using drive aisles, parking areas, walkways, paths, and bicycle routes addressing both vehicles and pedestrians.
14. Applicably coordinate heat island mitigation in paving and roof designs when implementing an integrated approach to stormwater management.
15. Consider the location of "Designated Tobacco Areas."

Setbacks

1. Consider adjacencies when establishing the front yard setback.
2. Generally maintain a front yard setback of not less than 30 feet where possible.
3. Maintain a side yard setback of not less than 40 feet between buildings.
4. Locate facilities and develop the site to allow for future expansions.
5. Maintain that area free from permanent development.
6. Designate future expansion in design floor plans and site plans.

Topography

1. Contour the land to optimize building location and orientation and use topography to screen negative impacts of large or unattractive elements.
2. Set floor elevations at no less than 11.5 feet above sea level, to avoid flooding.
3. Integrate building design with the topography.
4. Use berms to soften / screen views of parking areas or to reduce the visual height of buildings with raised floor elevations.
5. Use stepped earth berms to reduce the impact of elevated floors. Avoid a flat platform approach.
6. Add berms at selected open areas to counteract the flatness of the peninsula and to add interest.

Drainage

1. Grade sites to provide positive drainage away from buildings and traffic areas.
2. Provide a crushed rock drainage area around the perimeter of buildings that do not have gutters.
3. Shape retention / detention ponds in a natural, curvilinear manner.
4. Conform to existing topography to the greatest extent possible and use slopes to increase site and building efficiencies. Design sites to minimize irrigation and impacts to stormwater runoff.

C01.2. Building Orientation

Applicable N/A Select number of graphics / images (large: 800 px x 440 px) to insert 1

Image Tool 800 x 440

Applicable N/A Small graphics do not apply



Optimum Building Orientation

1. Ensure the site will accommodate optimum requirements for building orientation, which is with the long axis parallel to the east/west direction for rectilinear buildings.
2. Meet Installation Facilities Standards (IFS) requirements for the locations of the building's passive and renewable-energy systems and exterior shading systems.
3. Locate the building(s) and permitted ancillary structures to promote solar gain, solar shading, wind buffering and other beneficial passive systems.
4. Consider relationships to adjacent sites and their facilities and infrastructure, and cost effectively integrate building systems to harvest heat, grey water or other beneficial byproducts.
5. Consider the "public side" of the building, its views and the location of the main entrance.
6. Proper placement of facilities according to function, style, and size is essential. A building's function is a determining factor in the aesthetic character of the resulting facility. For example, a more utilitarian building such as a warehouse would be visually out of place amongst a group of administrative buildings. It is equally important to allow for the possibility of expansion or alteration of facilities as mission requirements change.
7. Site and configure buildings to reflect project requirements and to respond to conditions identified with a proper and complete site analysis.
8. Locate primary entrances to face parking areas. Provide additional entrances to address the street or building drop-offs when functionality necessary.

9. Avoid siting service or storage yards along primary or secondary street fronts whenever possible.
10. Include ATFP requirements and blend measures into facility and site design.
11. Avoid location buildings in transition spaces.
12. Use sites to infill where possible and avoid "urban sprawl".
13. Avoid location buildings in low-lying areas.
14. Provide a landscape transition space between visually discordant settings and special use areas.

C02. UTILITIES

Comply with AF Corporate Standards for Site Development:

<http://afcs.wbdg.org/site-development/index.html>

Comply with AF Corporate Standards for Utilities:

<http://afcs.wbdg.org/site-development/utilities/index.html>

C02.1. Utility Components

Applicable N/A Large graphics do not apply

Applicable N/A Select number of graphics / images (small: 250 px x 188 px) to insert 3

Image Tool 250 x 188



Painted Utility Components to Match Wall



Screened Utility Component



Screen Wall for Utility where ATFP Permits

1. Visually integrate utilities into the built environment and reduce visual clutter. Coordinate utility systems with landscape features and allow plantings to be an aesthetically pleasing focus.
2. Provide all on-site utility service lines below grade for all Facility Groups. Avoid free standing utility structures where possible. When mounting elements (such as utility cabinets, communications equipment and water valves) above grade is unavoidable, paint these consistently and provide visual screening following Installation Facilities Standards (IFS). Exposed conduits, cables, and wires are not permitted. Provide underground vaults for equipment where possible. Locate pad mounted equipment in less visible areas and screen with landscaping or screen walls.
3. Consider utility infrastructure to support near term and future electric vehicle charging stations.
4. Define all service entry points into the building and route distribution below grade into an interior space within the facility; exposed conduits, cables and wires on exterior walls are not permitted for Facility Group 1.
5. Limit exterior mechanical distribution systems such as exterior steam, chilled water, and hot water distribution to Group 3 facilities; when required for Group 1 and 2 facilities integrate with the architecture and provide visual screens following IFS.

6. Direct roof drainage to underground collection when feasible or provide splash blocks / paved channels to intercept roof drainage at grade.

Fire Hydrants

1. Locate hydrants at least 5 feet away from other structures. Maintain a 30-inch clear area around the hydrant.
2. Paint hydrants per the Fire Department Direction (Authority having jurisdiction).

Mechanical/Equipment Components

1. Carefully place and organize equipment and services.
2. Locate Mechanical equipment on the least public side of the building.
3. Screen all mechanical equipment with landscaping material or screen walls.
4. If mechanical equipment is placed within 10 feet of a building, paint to match the wall color. If placed farther than 10 feet, paint brown.

Communications

1. Collocate coaxial and telephone exterior components at the entry points to the building.
2. Align all communications components with one another on the horizontal and vertical plane.
3. Minimize the use of all externally attached meters and control devices. If used, paint to match the wall color.
4. Externally attached utility conduits, lines, or equipment (except meters and control devices) are not allowed.

C03. PARKING AREAS

Comply with AF Corporate Standards for Site Development:

<http://afcs.wbdg.org/site-development/index.html>

Comply with AF Corporate Standards for Parking Areas:

<http://afcs.wbdg.org/site-development/parking-areas/index.html>

C03.1. Configurations and Design

Applicable N/A Select number of graphics / images (large: 800 px x 440 px) to insert 1

Image Tool 800 x 440

Applicable N/A Small graphics do not apply



Covered Drop-off

1. Evaluate adjacent sites and cost-effectively consolidate parking areas to maximize efficient use; ensure that all areas meet accessibility guidelines.
2. Generally envision on-site parking as a series of small connected singular areas selectively placed around the facility served, rather than a single large area; buffer parking areas from the facility main entrance with a transition space and provide drop-offs to decrease close-in parking. Comply with IFS standards while meeting ATRP requirements.
3. Integrate at-grade and raised-profile curbing, permeable paved areas, and parking islands with the stormwater system and direct stormwater to bioswales and rain gardens as source water for regionally appropriate native vegetation.
4. Define pedestrian access with approved hardscape and provide shading along the primary path from the parking area to the main entrance of the building.
5. Coordinate suitable landscape or barriers integrated with walls and fences to ensure adequate force protection.
6. Accessible parking spaces shall be marked according to UFC 3-120-01 and its references in ABAAS and the MUTCD.
7. Consider locations and requirements of near term and future electric vehicle charging stations.
8. Designate preferred parking spaces for electric vehicles and carpools near the main entrance.
9. Consider cost-effectively integrating solar photovoltaic arrays into covered parking structures.
10. Reserved parking is discouraged except for Facility Group 1.

11. On-street parking is discouraged except in multi-use areas. When used, provide approved on-street parking configurations following UFC 3-201-01.

12. Access and service drives should accommodate the largest vehicle serving the facility.

C03.1.1. Paving and Striping

Applicable N/A Large graphics do not apply

Applicable N/A Small graphics do not apply

Facility Group 1 paving materials shall be as follows.

Primary: Asphalt

Secondary: Concrete

Accent: N/A

Facility Group 2 paving materials shall be as follows.

Primary: Asphalt

Secondary: Concrete

Accent: N/A

Facility Group 3 paving materials shall be as follows.

Primary: Concrete

Secondary: N/A

Accent: N/A

Facility Group 4 paving materials shall be as follows.

Primary: Asphalt

Secondary: N/A

Accent: N/A

Lot Layout

1. Use the 90-degree parking configuration when possible. Adjustments are allowed if space is inadequate or if turnover is high.
2. Coordinate entries with other adjacent drives or roads to assure well designed circulation patterns.
3. Keep parking angles consistent within each parking area.
4. More than 35 spaces require more than one access point.
5. The standard stall size is 9 feet by 19 feet.

Reserved Parking

1. Minimize designated parking spaces by name, rank, or title.
2. Reserve consolidated parking sections instead of individual stalls.
3. When required, use curb-mounted signs.
4. Provide handicap parking and access.
5. Incorporate designated motorcycle parking within each parking area.

Recreational Vehicle Parking

1. Keep all recreational vehicles on combined lots located away from the heart of the installation.
2. Visually screen storage areas from public spaces.

Painting and Striping

1. Paint stall separation lines with a white, 4-inch wide single stripe.
2. Use reflective traffic paint for crosswalk stripes and acrylic paint for parking stripes.

C03.1.2. Curbing

Applicable N/A Large graphics do not apply

Applicable N/A Select number of graphics / images (small: 250 px x 188 px) to insert 2

Image Tool 250 x 188



Rounded Curb Configuration



Edge Defining Curb

Facility Group 1 curbing / edging materials shall be as follows.

- Primary: Concrete
- Secondary: N/A
- Accent: N/A

Facility Group 3 curbing / edging materials shall be as follows.

- Primary: Concrete
- Secondary: N/A
- Accent: N/A

Facility Group 2 curbing / edging materials shall be as follows.

- Primary: Concrete
- Secondary: N/A
- Accent: N/A

Facility Group 4 curbing / edging materials shall be as follows.

- Primary: Concrete
- Secondary: N/A
- Accent: N/A

1. Provide asphalt paving as the standard.
2. Use concrete where required for heavy vehicles, motorcycle parking, and where fuel spills may occur.
3. Use 6-inch integrated concrete curb and gutter for parking areas. Asphalt curbs, wood timbers, and pre-cast wheel stops are not allowed.

C03.1.3. Internal Islands and Medians

Applicable N/A Large graphics do not apply

Applicable N/A Small graphics do not apply

1. Provide planting medians for every four rows of vehicles and planting islands for every 20 stalls.
2. Provide designated areas for pedestrian cross traffic.
3. Use coordinated lighting standard layout within island placement.

C03.2. Parking Structures

Applicable N/A Large graphics do not apply

Applicable N/A Small graphics do not apply

1. Parking structures are encouraged in land-constrained locations when economically feasible.
2. Consider near term and future electric vehicle charging stations and renewable energy generation development during the analysis and design.
3. Consider opportunities for integrating parking structures into multi-use developments with pedestrian-oriented uses located on the ground floor and parking on upper levels; ensure AFTP guidelines are fully addressed.
4. Structures may be constructed below grade with roofs serving as vegetated areas or plazas.

C03.3. Connectivity

Applicable N/A Large graphics do not apply

Applicable N/A Small graphics do not apply

1. Refer to the Installation Development Plan (IDP) for locations of transit stops and pedestrian and cycling networks; provide appropriately sized sidewalks and bike paths to connect facilities and users to these networks.
2. Provide amenities such as rain and shade shelters, trees, and benches to encourage and facilitate use of public transportation.
3. Evaluate the IDP for the current and planned network of roads and optimally develop vehicular access to and from the site.

C04. STORMWATER MANAGEMENT

Comply with AF Corporate Standards for Site Development:

<http://afcs.wbdg.org/site-development/index.html>

Comply with AF Corporate Standards for Stormwater Management:

<http://afcs.wbdg.org/site-development/stormwater-management/index.html>

C04.1. Stormwater Requirements

Applicable N/A Large graphics do not apply

Applicable N/A Select number of graphics / images (small: 250 px x 188 px) to insert 6

Image Tool 250 x 188



Water Feature



Storm Drainage Discharge Elements



Detention Pond as Amenity



Landscaped Basin



Terraced Topography



Drainage Outlet Detail

1. Design all stormwater systems including retention ponds, detention areas, channels, etc. as on-site amenities that are consistent with natural systems and drainage patterns, that help sustain the base landscape with beneficial functionality and that provide aesthetic appeal; coordinate with the base Stormwater Management Plan.
2. Incorporate bioswales into the design of all roadway, parking and facility roof systems to enhance water quality and support the overall stormwater system.

C05. SIDEWALKS, BIKEWAYS AND TRAILS

Comply with AF Corporate Standards for Site Development:
<http://afcs.wbdg.org/site-development/index.html>

Comply with AF Corporate Standards for Sidewalks, Bikeways and Trails:
<http://afcs.wbdg.org/site-development/sidewalks-bikeways-trails/index.html>

C05.1. Circulation and Paving

Applicable N/A Large graphics do not apply

Applicable N/A Select number of graphics / images (small: 250 px x 188 px) to insert 5

Image Tool 250 x 188



Pedestrian Circulation

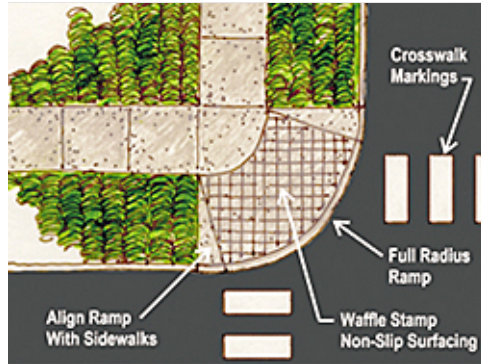

Crosswalk and Curbing



Recreational Pedestrian Jogging Path



Group 4 Pedestrian Path



Alignment with Entrance

Facility Group 1 sidewalks, plazas, and courtyards paving materials shall be as follows.

Primary: Concrete

Secondary: N/A

Accent: N/A

Facility Group 2 sidewalks, plazas, and courtyards paving materials shall be as follows.

Primary: Concrete

Secondary: N/A

Accent: N/A

Facility Group 3 sidewalks, plazas, and courtyards paving materials shall be as follows.

Primary: Concrete

Secondary: N/A

Accent: N/A

Facility Group 4 sidewalks, plazas, and courtyards paving materials shall be as follows.

Primary: Concrete

Secondary: N/A

Accent: N/A

1. Maintain efficient geometry and accessibility to connect building entrances to adjacent parking areas and activity areas and to the base transportation system following ATRP. Efficiently use materials to optimize life-cycle costs and to minimize maintenance.

2. Generally conform horizontal layouts of sidewalks to the geometric configuration of adjacent buildings, streets, parking lots, and other adjacent related site amenities. Occasional meanders and/or jogs may be included to capture views, to coordinate with landscaping or accommodate site constraints. Provide curvilinear / meandering walks for dormitory and housing areas.
3. Walks in parking areas shall provide a direct path using "safe islands" and "peninsulas" to encourage safety. Walks parallel to streets shall follow streetscape guidelines. Clearly mark pedestrian crossings at vehicular routes.
4. Pedestrian paths should be at least 5' in width to allow for comfortable side-by-side walking and not less than 5 feet from all primary, secondary, and access roadways. Do not make any sidewalk smaller than 3 feet wide.
5. Sidewalks leading to a building main entrance and at the interior of parking lots shall be a minimum width of 6'. Walks greater than 10' wide may be used at high-density pedestrian areas where volumes of traffic justify added material.
6. Where cars park adjacent and head-in to the sidewalk and wheel stops are not used, such perimeter walks shall be increased to a minimum width of 8' to accommodate overhangs of the parked vehicles.
7. All sidewalks shall have positive drainage to prevent ponding of water with slopes ranging from 2.1% to 4.2%. Walks with a slope greater than 4.2% shall be designed as ramps following accessibility guidelines. All walks shall have a minimum cross slope of 2.1%.
8. Use terra cotta colored concrete pavers, refined joint patterns, or scoring in high visibility special areas. Pavers shall conform to the following range of color: Terra Cotta/Buff. Use natural colored concrete with a broom finish and troweled edges for all walkways in developed areas.
9. Connect to the bicycle circulation system and provide bicycle parking with a suitable means for securing bicycles following IFS. Consider changing/shower facilities for use by cyclists.
10. Refer to the Installation Development Plan for future trails, bicycle paths, and sidewalks.

Crosswalks and Ramps

1. Ensure that all paths lead to the safest crossing point possible, and cross roadways at 90-degree angles.
2. Incorporate ADA access curb ramps and crosswalk markings into all crosswalks.
3. Construct crosswalks of terra cotta colored concrete pavers with natural gray concrete edging at high-visibility locations to improve safety.
4. Construct all concrete curb ramps with a waffle stamp pattern and flared curb ramps.
5. Provide for adequate drainage away from the ramp or by drainage grates.

Recreational Trails

1. Provide a minimum, 6-foot paved width in a free form configuration that follows the contours or other natural features.
2. Separate the trail system from vehicular traffic by a minimum of 10 feet when running parallel to roadways.
3. Take advantage of natural environments such as the golf course, wetland areas, and the beachfront. Make the walk pleasant by incorporating activity generators, interpretive signs and recreation opportunities along the trail.

C05.1.1. Ramps and Stairs

Applicable N/A Large graphics do not apply

Applicable N/A Select number of graphics / images (small: 250 px x 188 px) to insert 2

Image Tool 250 x 188



Site Ramp at Recreational Area



Integrated Stair

1. Use ramps instead of stairs for sidewalks, bikeways and trails and at all buildings where possible. Where steps are unavoidable, follow UFC 1-200-01 and its references to the international Building Code.

C05.1.2. Lighting

Applicable N/A Large graphics do not apply

Applicable N/A Select number of graphics / images (small: 250 px x 188 px) to insert 1

Image Tool 250 x 188



Landscape Lighting Fixture

1. Provide lighting for all stairs and landings where traffic warrants.
2. Refer to the Lighting section for path lighting along sidewalks, bikeways and trails.

C06. LANDSCAPE

Comply with AF Corporate Standards for Site Development:

<http://afcs.wbdg.org/site-development/index.html>

Comply with AF Corporate Standards for Landscape:

<http://afcs.wbdg.org/site-development/landscape/index.html>

C06.1. Climate-based Materials

Applicable N/A Select number of graphics / images (large: 800 px x 440 px) to insert 1

Image Tool 800 x 440

Applicable N/A Select number of graphics / images (small: 250 px x 188 px) to insert 2

Image Tool 250 x 188



Regionally Appropriate Plantings

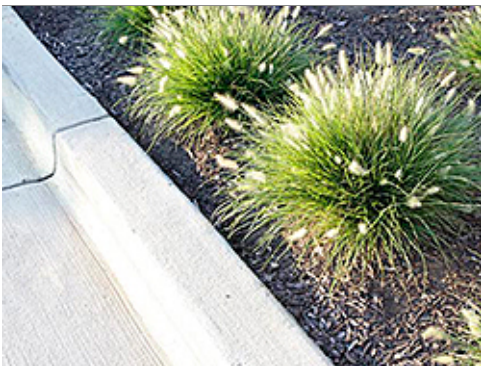

Non-irrigated Landscape



Foundation Plantings

1. Use only native, naturally occurring, drought tolerant indigenous plant species (including grasses) appropriate for the locale to promote energy efficiency and water conservation, preserve drainage patterns, inhibit erosion, improve air quality, lower maintenance, and add beauty.
2. Develop the Florida Coastal aesthetic with regional plant materials in curvilinear layouts. Include landscaping with all new facilities and use it to enhance / unify existing non-conforming facilities and create base-wide continuity.
3. Reduce the negative visual impact of unsightly features with landscape screening.

- 4. Apply three-tiered planting schemes of ground cover, shrubs, and trees using a variety of species in lush combinations to provide seasonal color.

C06.1.1. Landscape Design Concept

Applicable N/A Large graphics do not apply

Applicable N/A Select number of graphics / images (small: 250 px x 188 px) to insert 6

Image Tool 250 x 188



Low Maintenance Planting Materials



Climate Based Landscaping



Climate Based Landscaping



Concrete Edging



Low Water Landscaping



Group 1 Tiered Landscaping

1. Develop, maintain and implement a climate-based plant list with landscape features using a regionally appropriate palette of materials to promote energy efficiency, preserve drainage patterns, inhibit erosion, improve air quality, lower maintenance and add beauty. Follow UFC 3-201-02 Landscape Architecture.
2. Landscaping is required for all newly developed sites and facilities; preserve existing native landscape where possible and avoid overplanting.
3. Concentrate landscaping in Facility Group 1 and along major thoroughfares and integrate these landscaped areas into the base's stormwater management plan. Refer to the Streetscape Envelope Standards in this IFS.
4. All Facility Group 1 and 4 sites shall be landscaped at their entire perimeter; limit formal planting arrangements to formal spaces typically associated with Group 1. Landscape public spaces near the main entrances of Group 1 facilities.
5. Facility Group 2 and 3 sites may have a native undisturbed landscape except at the main entrances of Group 2, which should be newly landscaped.
6. Facility plantings shall follow the Installation Facilities Standards (IFS) plant list, which is based on the specific microclimates created by the adjacent building: shadow areas, protected areas, zones adjacent to thermal mass, and availability of rainwater and/or grey water.

7. Provide open spaces as transitions between developed and native areas that promote quality of life and provide visual relief and allow walkable connections to the transportation system.
8. Return suitable areas to a natural state to minimize and, whenever possible, eliminate ground maintenance requirements; expand prairie areas where appropriate with native plants to eliminate mowing and maintenance requirements.
9. In tree clusters replace grass with naturalized shrub beds and leaf litter mulch to eliminate mowing requirements.
10. Use plantings in open spaces to reinforce the space as a visual asset.
11. Consider landscape windbreaks when suitable for the local climate.
12. Integrate security requirements into the landscape design. Coordinate the heights of trees and shrubs and note restrictions for plantings following UFC 4-010-01.
13. Berms may be used as an integral part of the overall landscape strategy for screening, security and/or visual interest.
14. Follow plant material provider's installation recommendations for planting depth, spacing, soil conditioning, staking, fertilizing, and watering.
15. Do not unnaturally alter planting materials in any way, such as painting the bases of palms.
16. Use shredded cypress mulch in planting beds to reduce the need for weeding and to conserve water.
17. Reduce maintenance costs by using proper plant materials in configurations that do not require pruning.
18. Install sprinkler systems to reduce maintenance costs.
19. Use timers and electronic water gauges to avoid over-watering.
20. Refer to plant material providers for recommendations on salt tolerance.
21. Plants in certain locations will be impacted by ground water.

Edging

1. Provide poured concrete edging at planting beds as the standard.
2. Separate and define all planting areas with sod cut edging at a minimum.
3. Use concrete paver edging in the most visible and important locations.
4. Use spade cut edging for Self-Help projects.
5. Do not use wood timber edging in any applications.

Landscape Screens

1. Where possible use landscaping instead of walls for screening.
2. Use a three-tiered landscape screen that combines ground covers, shrubs, and small trees with walls and fences.
3. Use shrubs or vines on trellis structures to hide unsightly equipment or otherwise control the visual environment.

Open Space

1. Low lying areas between facilities, even though less visually important, still require careful consideration. Use the proper ground cover to visually tie the larger pieces of the landscape together and to help prevent soil degradation.

Ground Covers

1. Use turf for all recreation areas, parade grounds, lawns, and open fields.

2. Create undeveloped natural areas using native grasses and shrubs. Incorporate no-maintenance ground cover materials in areas of steep slope or areas that are difficult to maintain.

C06.1.2. Xeriscape Design Principles

Applicable N/A Large graphics do not apply

Applicable N/A Small graphics do not apply

1. Apply xeriscape principles following UFC 3-201-02, Appendix B, and Air Force Corporate Facilities Standards.
2. Facility plantings are encouraged to use native plant species and to consider specific microclimates created by the adjacent building: shadow areas, protected areas, zones adjacent to thermal mass, and availability of rainwater and/or grey water.

C06.1.3. Minimizing Water Requirements

Applicable N/A Large graphics do not apply

Applicable N/A Small graphics do not apply

1. Reasonably reduce demand on potable water while seeking opportunities to increase alternative water sources for irrigation. Reduce or eliminate the use of potable/domestic water for purposes of landscape architecture maintenance, consistent with existing legal or contractual obligations, and prohibit potable-water irrigation in new construction beyond establishment following current DoD and Air Force policy.

C06.1.4. Plant Material Selection

Applicable N/A Large graphics do not apply

Applicable N/A Small graphics do not apply

1. Use only native, naturally occurring plant materials including grasses or turf suited for the local climatic conditions in the landscape design; potable-water irrigation systems are discouraged beyond the establishment period.
2. New facilities are encouraged to use native plant species as indicated on the following plant lists: http://edis.ifas.ufl.edu/topic_landscape_plants.
3. Trees should be the focus of landscape plantings and, where possible, should be a mix of deciduous and evergreen species for variety; provide tree grates when appropriate and use tree guards on smaller trees.
4. Ground covers are only recommended when minimal maintenance is required.
5. Turf areas should be limited to those that can be sustained by natural rainfall or grey water (non-potable) irrigation systems; turf may be defined by at-grade concrete mow strips to lessen maintenance.
6. Analyze soils and provide organic amendments as needed to improve plant growth and conserve water.
7. All plant material shall have one-year warranty and is subject to approval by the Base Landscape Architect.

C06.1.5. Water Budgeting (Hydrozones)

Applicable N/A Large graphics do not apply

Applicable N/A Small graphics do not apply

1. Comply with DoD and Air Force policy on potable-water irrigation systems.
2. Provide irrigation systems in new construction to establish plant materials following “Water for Landscaping” in UFC 1-200-02. Note the climate zone and annual rainfall for the locale.
3. New buildings shall cost-effectively integrate a grey-water reclamation system following UFC 1-200-02, which provides source water for an automatic drip irrigation system; connect adaptive plantings adjacent to facilities to a grey-water irrigation system when available and discontinue the use of potable water for irrigation after the establishment period.
4. Provide irrigation design following UFC 3-201-02. Install drip irrigation products and components following UFGS Section 32 84 24 Irrigation Sprinkler Systems. Match the color of valve box lids to the adjacent ground treatment (i.e. green at turf & native seed areas, brown at wood mulch & rock areas).
5. Life cycle cost-effectively equip irrigation systems to sense soil moisture, rainfall and wind to minimize unnecessary watering; incorporate drip irrigation systems as the primary source.

C06.1.6. Base Entrance Landscaping

Applicable N/A Large graphics do not apply

Applicable N/A Small graphics do not apply

1. At the main gate, reinforce a sense of arrival through a well-designed concentration of landscape elements consistent in visual quality with Facility Group 1.
2. Ensure landscaping has seasonal features with spring and fall color and a combination of evergreen and deciduous trees and shrubs for winter interest.
3. Integrate base signs and street and pedestrian lighting whenever feasible.

C06.1.7. Streetscape Landscaping

Applicable N/A Large graphics do not apply

Applicable N/A Select number of graphics / images (small: 250 px x 188 px) to insert 3

Image Tool 250 x 188



Deciduous Trees Adjacent to Road



Formal Planting at High-Visibility Area



Informal Planting at Parking

1. Provide landscape designs with plant materials appropriately representing the level of quality of the adjacent Facility Group number to enhance the installation and reinforce the hierarchy of streets. Refer to the Installation Elements section.
2. Select a variety of regionally appropriate streetscape plantings and grading to create a visual interest.
3. Primary roadways use same species, deciduous street trees equally spaced to coordinate with light standards.
4. Use palms on high-profile primary streets equally spaced to coordinate with light standards.
5. Secondary and access roadways use a more random spacing of mixed species in clusters and / or groupings at focal points.
6. Plant deciduous street trees on the building side of sidewalks.
7. Reduce the density of plantings in the Industrial / Flightline area.

C06.1.8. Pedestrian Circulation Landscaping

Applicable N/A Large graphics do not apply

Applicable N/A Small graphics do not apply

1. Define walkways with landscaping where appropriate.
2. Provide rest areas along the pedestrian circulation network with human-scaled deciduous shade trees. Supplement tree plantings with finely textured shrubs when appropriate for the climate.
3. Provide wind breaks where required.
4. Incorporate formal plantings at high visibility areas along the trail system.
5. Use informal groupings of trees, shrubs, and flowers at rest stops, play areas, and intersections.

C06.1.9. Parking Lot Landscaping

Applicable N/A Large graphics do not apply

Applicable N/A Select number of graphics / images (small: 250 px x 188 px) to insert 3

Image Tool 250 x 188



Median and Island Landscaping



Trees to Provide Shade



Visually Softening Parking Lot

1. Integrate appropriate landscaping elements into parking areas to visually soften the appearance at a minimum rate of three percent of the total area.
2. Avoid trees that drop sap, fruit, or seeds, and use long-lived species; keep trees trimmed, removing dead and dying trees or branches.
3. Provide planting in islands within parking lots for shade and appeal following IFS and the base stormwater management plan.
4. Rain garden islands shall be landscaped to receive rainwater runoff from adjacent impervious parking areas to be absorbed into the ground/planting bed. Native plants and groundcovers are recommended within the rain garden areas, which can survive without supplemental irrigation once established.

C06.1.10. Screen/Accent Landscaping

Applicable N/A Large graphics do not apply

Applicable N/A Select number of graphics / images (small: 250 px x 188 px) to insert 3

Image Tool 250 x 188



Group 1 Native Plantings



Group 4 Landscaping



Group 1 Landscaping

1. Provide complimentary accent landscaping at monuments and static displays.
2. At Facility Group 1, provide landscaping adjacent to all freestanding signs without distracting from the written communication.

3. Provide landscape screening of utility elements adjacent to Facility Group 1.
4. Providing landscaping as visual screening is preferred to the construction of walls and fences; berming and mounding may supplement landscape screening.

C06.1.11. Other

Applicable N/A Large graphics do not apply

Applicable N/A Select number of graphics / images (small: 250 px x 188 px) to insert 6

Image Tool 250 x 188



Landscape to Soften Facility



Informal Planting



Informal Planting



Group 4 Planting



Group 4 Planting



Trees Accenting Entrance

FACILITY LANDSCAPING

1. The goals of facility landscaping are to provide a soft transition from the horizontal ground plane to the vertical building plane, to highlight building entries and features.
2. Hide unattractive building features such as utility risers or service areas.

Community (Groups 1, 2, and 3)

1. Use landscaping elements that compliment building architectural features and proportions.
2. Design randomly spaced plantings and tree massing to fill-out areas between facilities.
3. Front facades, especially along Florida Keys Ave., are to have a consistent landscaping of a limited palette.
4. Limit the use of palms to entries and high-visibility areas by framing desired views.
5. Use ground covers within planting beds.

Industrial / Flightline

1. Use landscaping to soften and reduce the scale of larger facilities.
2. Minimize the use of deciduous trees and shrubs to prevent leaf buildup along the apron and runway.
3. Reduce the quantity of landscaping by grouping landscape elements at entries and high-visibility areas.

Residential (Group 4)

1. Provide a transition from the elevated housing units to the ground plane and hide unattractive elements such as HVAC units.
2. Use mixed species in an informal planting style.
3. Use randomly spaced plantings and tree massing.
4. Reinforce pedestrian routes with landscaping to add user appeal.
5. Provide accent plantings at neighborhood entries.

C07. SITE FURNISHINGS

Comply with AF Corporate Standards for Site Development:

<http://afcs.wbdg.org/site-development/index.html>

Comply with AF Corporate Standards for Site Furnishings:

<http://afcs.wbdg.org/site-development/site-furnishings/index.html>

C07.1. Furnishings and Elements

Applicable N/A Large graphics do not apply

Applicable N/A Small graphics do not apply

1. Provide a coordinated consistent inventory of site furnishings to positively contribute to the visual environment, image, and identity of the base; ensure durability, low maintenance, reduced visual clutter, and compatibility with the adjacent architecture.
2. Remove poorly located or redundant litter / ash receptacles, newspaper and bicycle racks, telephone booths, vending machines, walls and fences to reduce visual clutter and to lessen the requirements for maintenance.
3. Group 1 and 2 site furnishing shall be dark bronze metal. Group 3 and 4 site furnishings shall be dark bronze metal. Generally match the site furniture of adjacent facilities and the facility district.
4. Install needed outdoor seating (benches and low walls) in public gathering spaces near main and secondary building entrances. Low walls shall match facility architecture.
5. Benches in Groups 1, 2 and 3 shall be dark bronze metal. Provide recycled plastic and metal benches in Group 4 and parks. Use factory finished metal benches and seats in all settings.
6. Integrate functional bicycle racks with the design of the building's main entrance grounds in Facility Groups 1 and 2 while meeting ATFP requirements.
7. Limit the use of bollards, but when necessary for force protection use dark bronze metal capped bollards. Illuminated bollards may be used as approved on a case basis.
8. Locate architecturally coordinated containers for recycling, litter, ash, vending, etc., to minimize visual clutter and not visible from the building's main entrance. Minimize the use of freestanding planters.

9. Generally limit picnic tables, barbeque grills and drinking fountains to lodging, dormitories, housing areas, parks and recreation areas following IFS.
10. The Installation Flagpole location shall comply with the guidance for the display of flags in AFI 34-1201. Each Air Force installation is authorized to fly one United States Flag, normally in front of the installation headquarters. Waivers for non-authorized locations must be submitted in accordance with AFI 33-360 and approved waivers (AF Form 679) must be maintained by the installation protocol office.
11. Refer to the Overview Section "Facility Hierarchy" topic of this AFCFS for guidelines regarding ancillary structures such as pavilions and shade shelters.
12. Bus shelters shall be provided only where there is a documented need and when approved on a case basis. Waiting shelters shall use stucco walls with dark bronze mullioned infill windows and a terra cotta tile, hipped roof.
13. Monuments and static displays shall be limited. New elements are generally discouraged unless these are fully vetted through the base's approval process and designed following IFS.
14. When visual screening is necessary, consider landscaping as the first option; where permitted, screen walls are finished with split-faced concrete masonry units in two contrasting colors.
15. For fencing, apply the standards for "Products, Materials and Color" in the following section. Limit those with the highest visual quality to Facility Group 1 where there is sustained maintenance. Define all levels of security and visual quality. Use stucco columns with black metal fence or split-faced CMU with concrete cap pyramid. Dark brown, vinyl covered chain link fence in industrial and low-visibility site is allowed with Base approval. Perimeter fencing shall respond to the site context. Use decorative metal and stucco, split-faced block, or stucco with accent.
16. Do not use chain-link fencing at Group 1, 2 or 4 facilities; Limit the use of barbed-wire outriggers on chain-link fencing at industrial sites, unless required for additional security or protection of assets.
17. Wood fencing may be used in Facility Group 4 for shadowbox fencing for trash enclosures and backyard privacy and in recreation areas following IFS for material and finish when there is sustained periodic maintenance.
18. Provide trash dumpster enclosures for Group 1 with split-faced concrete masonry unites or stucco to match adjacent facilities and for Groups 2 and 3 with split-faced concrete masonry unites or stucco (materials and type); all gates shall be metal factory finished Brazil Nut or See Pearl, depending on location. Provide Brazil Nut colored protective bollards. Design enclosures as part of the building service area for new facilities. Ensure compliance with all ATFP requirements. Provide concrete pads and access aprons to enclosure. Include landscaping areas and provisions for pedestrian access.
19. Specify screen wall materials and finishes that do not require painting or maintenance beyond periodic cleaning. Construct free-standing garden walls of buff colored split-face block with pebble colored accents. Do not place screen walls immediately adjacent to roadways or sidewalks. Use landscaping to soften walls.
20. Limit the use of freestanding planters to areas with ongoing maintenance.
21. Provide kiosks only where there is a documented need for visual communication of posted messages. When used, match adjacent facilities in materials and detailing and consolidate kiosks with other site furnishings within 30 feet of major pedestrian paths. Limit kiosks to facility Groups 1 and 2 and parks. Kiosks shall be constructed of galvanized metal posts supporting inset bulletin board panels covered by a terra cotta tile hipped roof.
22. Refer to the following UFCs:
 - UFC 4-740-14 Design: Child Development Centers
 - UFC 3-201-02 Landscape Architecture
 - UFC 4-740-15 Continuous Child Care Facilities
 - UFC 4-023-10 Safe Havens
23. Force protection shall be integrated in design planning. Use a combination of walls, bollards, and tension cables with landscape beds. Do not paint Jersey Bollards. Minimize the visibility of all force protection devices with landscaping and integral design.

24. Manufacturers listed below are only provided to establish a baseline of equivalency among all applicable manufacturers.

C07.2. Site Furnishings Products, Materials and Color

Note: Apply the below base-wide standards for Site Furnishings (products, materials and color). Then refer to the Appendix and apply any additional requirements specifically related to the Facility District in which the project is located.

C07.2.1. Barbeque Grills

Applicable N/A

C07.2.2. Benches

Applicable N/A

Number of base standards 1

Image Tool 250 x 188



Type: **Metal Bench**

Applies to: Group 1 Group 2 Group 3 Group 4 Other

Mfr: Varies

Color: Dark bronze

Finish: Factory

Model #: As approved by BCE

Other: N/A

UFGS: N/A

C07.2.3. Bike Racks

Applicable N/A

Number of base standards 1

Image Tool 250 x 188



Type: **Bollard-Type Bike Rack**

Applies to: Group 1 Group 2 Group 3 Group 4 Other

Mfr: Varies

Color: Dark bronze

Finish: Factory

Model #: Accommodate minimum two bicycles

Other: Screen bicycle parking areas with landscaping or screen walls. Place bike racks on concrete pads in accessible locations near established.

UFGS: N/A

C07.2.4. Bike Lockers

Applicable N/A

C07.2.5. Bollards

Applicable N/A

C07.2.6. Bus Shelters

Applicable N/A

Number of base standards 1

Image Tool 250 x 188

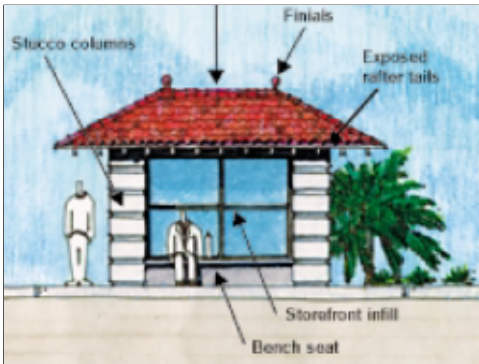

Type: **High Visibility Shelter**

Applies to: Group 1 Group 2 Group 3 Group 4 Other

Mfr: Varies

Color: Beige with Terra Cotta roof

Finish: Stucco walls with Dark Bronze windows, Terra Cotta Tile Roof

Model #: Custom

Other: N/A

UFGS: N/A

C07.2.7. Drinking Fountains

Applicable N/A

C07.2.8. Dumpster Enclosures / Gates

Applicable N/A

Number of base standards 1

Image Tool 250 x 188



Type: **Split-Faced Block and Metal Gate Enclosure**

Applies to: Group 1 Group 2 Group 3 Group 4 Other

Mfr: Varies

Color: Buff colored split-face block with pebble colored accents.

Finish: Split-Faced Block, Metal Gate and Poles

Model #: Coursed masonry, slatted or fluted steel sheeting

Other: N/A

UFGS: Section 04 20 00 Unit Masonry, Section 05 50 13 Misc. Metal Fab.

C07.2.9. Fencing

Applicable N/A

Number of base standards 1

Image Tool 250 x 188



Type: **High Visibility Fencing**

Applies to: Group 1 Group 2 Group 3 Group 4 Other

Mfr: Varies

Color: Beige/Dark Brown Metal

Finish: Stucco with Cap or Split-Face block with cap, galvanized metal

Model #: Brick Piers with steel posts, rails and pickets

Other: Column: 2'x2' (Height as required, equally spaced 12' to 40'), Steel posts: 4"x4" (equally spaced), Rails: 2"x2", Pickets: 1"x1" (6"o.c.); close all ends of tubing

UFGS: Section 04 20 00 Unit Masonry, Section 05 50 13 Misc. Metal Fab.

C07.2.10. Flagpoles

Applicable N/A

C07.2.11. Lighting – Landscape / Accent

Please refer to the Lighting section.

C07.2.12. Litter and Ash Receptacles

Applicable N/A

Number of base standards 1

Image Tool 250 x 188



Type: **Metal Litter/Ash Receptacle**

Applies to: Group 1 Group 2 Group 3 Group 4 Other

Mfr: Varies

Color: Dark bronze

Finish: Factory

Model #: As approved by BCE

Other: Locate out of view near entries to avoid visual clutter.

UFGS: N/A

C07.2.13. Picnic Tables

Applicable N/A

Number of base standards 1

Image Tool 250 x 188



Type: **Plastic and Metal Picnic Table**

Applies to: Group 1 Group 2 Group 3 Group 4 Other

Mfr: Varies

Color: Dark bronze base

Finish: Factory finished, recycled plastic picnic tables with metal frames

Model #: As approved by BCE

Other: N/A

UFGS: N/A

C07.2.14. Planters

Applicable N/A

C07.2.15. Play Equipment

Applicable N/A

C07.2.16. Screen Walls

Applicable N/A Number of base standards 1

Image Tool 250 x 188



Type: **Free Standing Garden Wall**

Applies to: Group 1 Group 2 Group 3 Group 4 Other

Mfr: Varies

Color: Buff colored split-face block with pebble colored accents.

Finish: Split-Faced CMU

Model #: Custom

Other: N/A

UFGS: Section 04 20 00 Unit Masonry

C07.2.17. Tree Grates

Applicable N/A Number of base standards 1

Image Tool 250 x 188



Type: **Cast Iron**

Applies to: Group 1 Group 2 Group 3 Group 4 Other

Mfr: Varies

Color: Black Cast Iron

Finish: Cast

Model #: 2-Piece, Round or square

Other: Uplight holes set in concrete pavers.

UFGS: N/A

C07.2.18. Other

Applicable N/A

Number of base standards 3

Image Tool 250 x 188

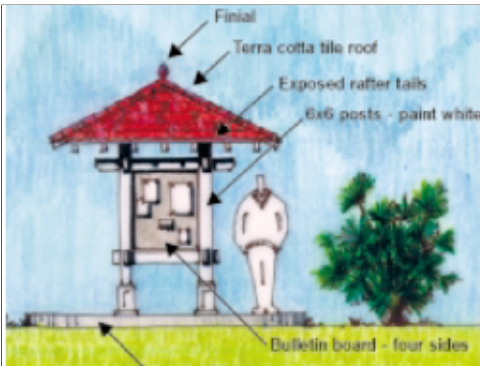

Type: **Kiosk**

Applies to: Group 1 Group 2 Group 3 Group 4 Other

Mfr: Varies

Color: Seed Pearl with Terra Cotta Tile Roof

Finish: Natural texture

Model #: As approved by BCE

Other: N/A

UFGS: N/A



Type: **Pavilion Style 1**

Applies to: Group 1 Group 2 Group 3 Group 4 Other

Mfr: Varies

Color: Seed Pearl with Terra Cotta Tile Hip Roof

Finish: Stucco

Model #: As approved by BCE

Other: Gazebos are not permitted

UFGS: N/A



Type: **Pavilion Style 2**

Applies to: Group 1 Group 2 Group 3 Group 4 Other

Mfr: Varies

Color: Seed Pearl with Terra Cotta Standing Seam Metal Hip Roof

Finish: Stucco and Dark Bronze Metal

Model #: As approved by BCE

Other: Gazebos are not permitted.
For use in industrial/flightline area. Concrete encased metal posts and standing seam metal roof.

UFGS: N/A

C08. EXTERIOR SIGNS

Comply with AF Corporate Standards for Site Development:

<http://afcs.wbdg.org/site-development/index.html>

Comply with AF Corporate Standards for Exterior Signs:

<http://afcs.wbdg.org/site-development/exterior-signs/index.html>

C08.1. Colors and Types

Applicable N/A Select number of graphics / images (large: 800 px x 440 px) to insert 1

Image Tool 800 x 440

Applicable N/A Select number of graphics / images (small: 250 px x 188 px) to insert 3

Image Tool 250 x 188



Base Entry Sign



Street Sign



Monument Sign



Squadron Street Sign

1. Provide concise functional signs as a positive visually unifying element with consistent colors and types for all Installation and Gate Identification Signs; Building Identification Signs; Traffic Control Devices; Directional and Wayfinding Signs; and Informational and Motivational Signs.
2. Provide signs with the lowest overall life cycle costs considering initial cost, ongoing maintenance and lifespan while meeting quality standards. Follow IFS for specifications appropriate for the local climate to withstand weathering.
3. Reduce the number of signs, reduce visual clutter and provide only essential signs required for identification, directions, instructions, and customer service following UFC 3-120-01. Remove non-conforming signs during renovation projects.

4. Use clear concise terms for content consistent with UFC 3-120-01.
5. Display of emblems on building exterior walls or other permanent structures is prohibited by UFC.
6. Raised "standout" letters and numbers may be used for Group 1 with approval on a case basis.
7. Group 2 and 3 facilities shall have wall mounted facility signs with sizes and layouts following UFC 3-120-01. Signs are not permitted for Group 4 facilities.
8. Only one identification sign is permitted at each building entrance. Include a building address consistent with US Postal Service protocols following UFC 3-120-01.
9. Traffic Control Devices, which regulate vehicular traffic on the installation, shall conform to the standards in the Manual of Uniform Traffic Control Devices (MUTCD) published by the Federal Highway Administration. Coordinate street signs with this IFS.
10. Provide Directional and Wayfinding Signs and address both pedestrian and vehicular traffic following UFC 3-120-01 for size, layout and content.
11. Reserved parking signs should be kept to a minimum. When approved, provide post-mounted sign faces in base standard materials and colors. Consider "bracketing" a designated area with a single sign at each end.
12. Parking lot identification signs may be used to identify areas or rows within large lots.
13. Follow the guidelines and requirements in ABAAS and the MUTCD for accessible parking signs.
14. Follow UFC 3-120-01 for Informational and Motivational Signs for size, layout and content.
15. Symbols or pictographs (graphic expressions of actual objects) may be used to indicate service, mandatory / prohibitory, sports, and recreation when rapid communication is necessary.
16. Force Protection signage may be applied to glass doors using white vinyl lettering.
17. Refer to UFC 3-120-01 for prohibited signs, which include those with animated, blinking, chasing, flashing, or moving effects.
18. Manufacturers listed below are only provided to establish a baseline of equivalency among all applicable manufacturers.

C08.1.1. Materials and Color Specifications

Applicable N/A Large graphics do not apply

Applicable N/A Select number of graphics / images (small: 250 px x 188 px) to insert 9

Image Tool 250 x 188

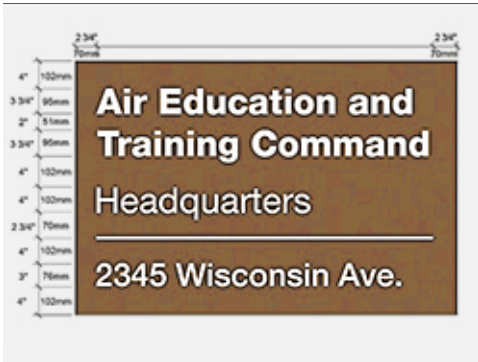

Typical Sign

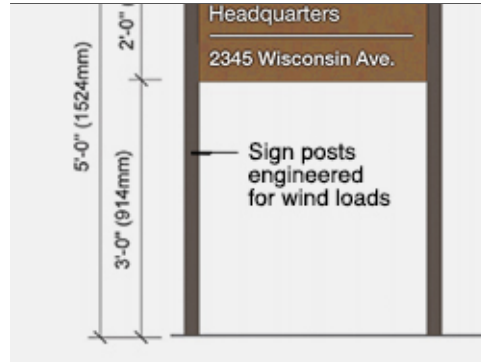

Typical Post Sign

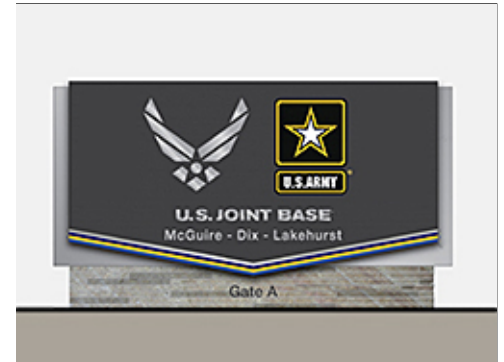

Typical Monument Sign

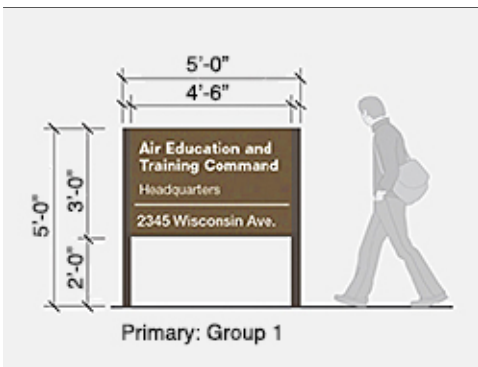

Typical Post-Mounted Primary Sign

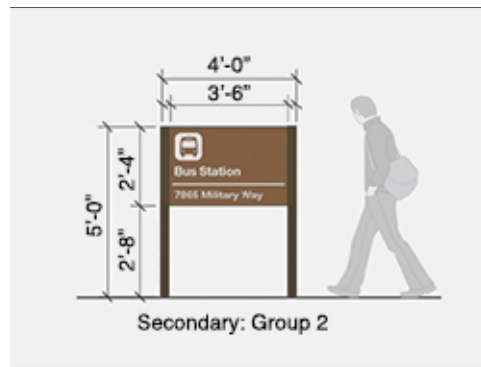

Typical Post-Mounted Secondary Sign

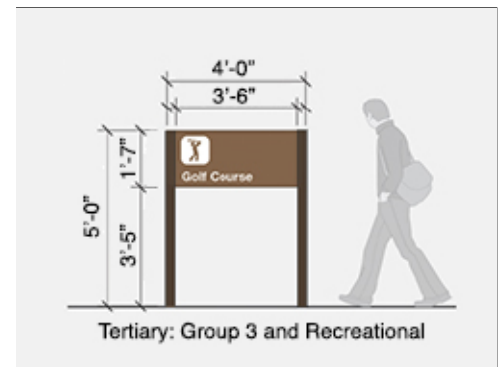

Typical Post-Mounted Tertiary Sign

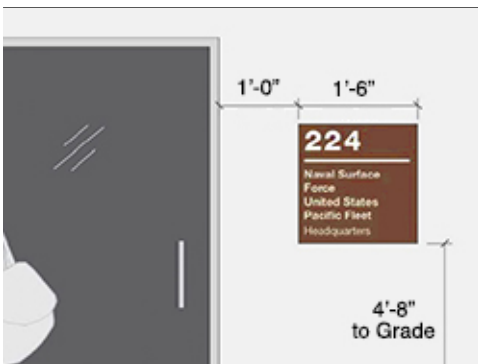

Typical Building Mounted Sign

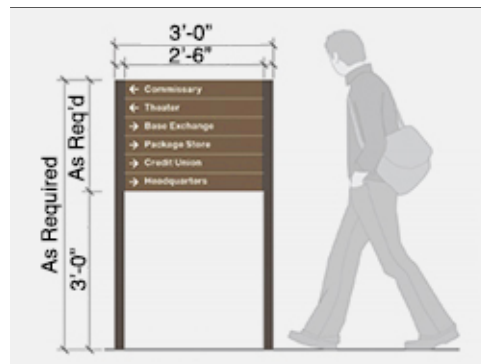

Typical Post-Mounted Directional Sign

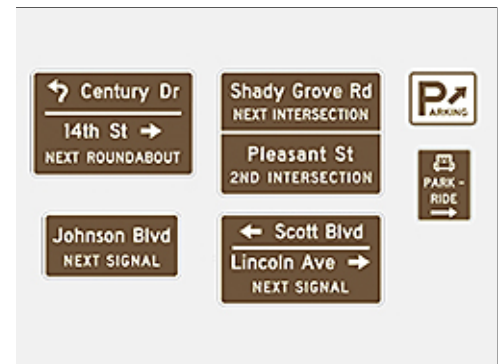

Typical Wayfinding Signs

1. Fabricate sign panels from metal with vinyl lettering. Square metal sign posts shall be metal with capped ends in a concrete base. Use Helvetica Medium in upper and lower case, primary information and Helvetica Light for secondary information.
2. Fence mounted sign panels may be attached with exposed fasteners. Front and back shall be the same color.
3. All signage shall follow Federal Highway Administration (FHWA) Manual on Uniform Traffic Control Devices (MUTCD) using standard colors. Refer to MUTCD color specifications, which provide cross-referenced Pantone Matching System (PMS) numbers.

- a. Standard Dark Bronze (also Federal Standard Color 30040)
- b. Standard Brown (**Park Service Brown**)

4. Limit the use of monument signs to entry gates, headquarters, and special use areas. Construct all monument signs of cast concrete with a Brazil Nut colored stucco finish. Use pin mounted Helvetica Letters.

Materials and Color Specifications

Applicable N/A Number of base standards 2

Image Tool 250 x 188



Type: **Post Sign**

Applies to: Group 1 Group 2 Group 3 Group 4 Other

Mfr: 3M

Color: Park Service Brown with Reflective white vinyl lettering

Finish: Powder coat / matte vinyl

Model #: Part #: 3939 Park Service Brown Prismatic Sheeting

Other: N/A

UFGS: N/A



Type: **Monument Sign**

Applies to: Group 1 Group 2 Group 3 Group 4 Other

Mfr: Varies

Color: Seed Pearl and Brazil Nut

Finish: Stucco with Metal Lettering

Model #: As approved by BCE

Other: N/A

UFGS: N/A

C08.1.2. Installation and Gate Identification Signs

Applicable N/A

Number of base standards 1

Image Tool 250 x 188



Type: **Main Gate Sign**

Applies to: Group 1 Group 2 Group 3 Group 4 Other

Mfr: Custom

Color: Split-Faced CMU in buff and pebble

Finish: Split-Faced CMU with Concrete Cap

Model #: As approved by BCE

Other: Comply with UFC 3-120-01

UFGS: Section 04 20 00 Unit Masonry

C08.1.3. Building Identification Signs

Applicable N/A

Number of base standards 1

Image Tool 250 x 188



Type: **Building-Mounted Sign**

Applies to: Group 1 Group 2 Group 3 Group 4 Other

Mfr: 3M

Color: Park Service brown with reflective white vinyl lettering

Finish: Satin

Model #: Part #: 3939 Park Service Brown Prismatic Sheeting

Other: N/A

UFGS: N/A

C08.1.4. Traffic Control Devices (Street Signs)

Applicable N/A Number of base standards 1

Image Tool 250 x 188



Type: **Street Sign**

Applies to: Group 1 Group 2 Group 3 Group 4 Other

Mfr: Varies

Color: Standard brown

Finish: Factory

Model #: As approved by BCE

Other: N/A

UFGS: N/A

C08.1.5. Directional and Wayfinding Signs

Applicable N/A

C08.1.6. Informational Signs

Applicable N/A Large graphics do not apply

Applicable N/A Small graphics do not apply

1. Minimize informational signs such as static display signs, hours of operation, and project signs to reduce visual clutter.
2. Static display signs shall have standard brown.
3. Hours of operation signs shall have a level of quality equivalent to the Facility Group number.
4. Temporary / Project Signage shall be judiciously placed to avoid visual clutter. Schedule and arrange for the removal of these signs prior to installation.

C08.1.7. Motivational Signage

Applicable N/A Large graphics do not apply

Applicable N/A Small graphics do not apply

1. Provide professionally produced motivational signs as important elements of campaigns to boost morale, improve safety, aid in recruiting, and accomplish other motivational objectives. Consolidate this signage to reduce visual clutter.

2. Motivational signs shall be limited to an electronic "marquee" type changeable sign near each gate. Temporary signs are not permitted. Motivational information may also be posted in a small, printed format on kiosks in specified, high pedestrian use areas. Refer to kiosks under Site Furnishings.
3. Follow UFC 3-120-01 for color and layout. Note that animated, blinking, chasing, flashing, or moving effects are prohibited by the UFC.
4. Mount marquee signs on reinforced concrete bases with a natural warm gray color.

C08.1.8. Parking Lot Signs

Applicable N/A

C08.1.9. Regulatory Signs

Applicable N/A

1. Regulatory signage, which restricts, warns and advises, shall be limited to those mandated under Highway/Traffic, Government Warning, and/or Parking Regulation. Follow UFC 3-120-01 and its industry references for color and layout.
2. Provide a comprehensive, systematic approach to regulatory signage to avoid clutter and confusion from "over signage."
3. Maintain base warning signs for safety and security at the base perimeter and at specific secure areas. Use these to notify visitors of restrictions governing conduct on the base, as well as other security procedures.

C08.1.10. Other

Applicable N/A

C09. LIGHTING

Comply with AF Corporate Standards for Site Development:

<http://afcs.wbdg.org/site-development/index.html>

Comply with AF Corporate Standards for Lighting:

<http://afcs.wbdg.org/site-development/lighting/index.html>

C09.1. Fixtures and Lamping

Applicable N/A Large graphics do not apply

Applicable N/A Select number of graphics / images (small: 250 px x 188 px) to insert 3

Image Tool 250 x 188



Architectural Uplighting



Uniform Lighting Design



Indirect Lighting for Sidewalk

1. Provide, coordinate and efficiently install street, parking lot, sidewalk and facility lighting with appropriate luminaires, lamping, placement and spacing following Installation Facilities Standards (IFS); ensure the level of quality is consistent with the adjacent facility group number. Pole-mounted, wall-mounted and bollard fixtures are permitted. All classifications of roadways will use the same luminaires, poles, and mounting height.
2. Judiciously use exterior lighting to enhance the visual quality of the base. Maintain consistent spacing and geometries of fixtures to create consistent visual rhythms.
3. Integrate controls to automatically reduce lighting power during periods of non-activity; automatically turn off power when sufficient daylight is available. Bury all utilities serving lighting fixtures.
3. Ensure continuity and consistency of lighting elements. In new construction generally match post types, fixture types, styles, heights, sizes, materials, colors, and lamp types of adjacent facilities and the facility district.
4. Provide adequate lighting at Group 4 for safety and comfort without allowing light pollution. Use recessed or consistently styled wall-mounted light fixtures.
5. Renewable energy power sources (such as solar photovoltaic) may be considered when feasible.
6. Use appropriately designed or shielded luminaires to direct light downward to minimize light pollution and intrusion onto adjacent sites. Control spillover light near residential areas.
7. Calculate illuminance levels for all lighting applications following UFC 3-530-01 and ensure compliance with pre-curfew maximum brightness level requirements.
8. Sufficiently address environmental factors to prevent corrosion and weathering of fixtures, plinths and other components.
9. Wall mounted fixtures should respond to the architectural character of the facility. Minimize the use of building mounted fixtures for general illumination of service yards and outdoor spaces.
10. Efficient accent lighting of architectural and landscape features may be provided for Group 1, lodging and historical applications. Accent lights in ground-mounted locations may be provided for static displays and signs when these do not conflict or cause hazards with overhead aircraft.
11. Comply with UFC 3-530-01 for light source technology and lamp types. High efficiency lamping such as LED is preferred for most applications.

12. Provide roadway lighting with round tapered, square non-tapered, or round non-tapered aluminum poles and aluminum fixtures with square, rectangular or circular housings in colors and shapes to match adjacent facilities and the facility district. Antiqued brown, factory finished, historical reproduction luminaires and poles may be used adjacent to historical structures. Equally space poles on alternating sides of all roadways. Provide fixtures at all four corners of intersections. Mount luminaires at 20 feet high.
13. Parking areas shall use arm mounted, square, shoebox-type luminaires in factory finished, dark bronze. Use multiple luminaires on dark bronze, square poles to reduce the number of poles needed. Coordinate pole placement with parking island locations.
14. Install natural warm gray color, smooth finished concrete bases for all poles in heights appropriate for the facility group and application. Generally Groups 1, 2 and 4 shall have at-grade bases. Group 3 shall have taller bases for added durability.
16. When parking lot lighting is necessary, provide an illuminated path to the building's main entrance. Pole bases should be contained within an internal landscape median or island.
17. Provide pedestrian-scaled lighting fixtures throughout housing area and along recreation trails and sidewalks not adjacent to roadways. Equally space light fixtures for sidewalks on same side of walk.
14. Install lighted bollards only at Group 1 and high-traffic Group 2 facilities. Generally match materials, colors and shapes of adjacent facilities and the facility district. Consistently install lighting for sidewalks, bikeways and trails to match adjacent facilities.
18. Landscape accent lighting may be used in public gathering spaces and in Group 1 facilities. Coordinate the design, luminaire selection, and placement with the location of trees, shrubs, and site furnishings.
19. Incorporate recessed, wall-mounted accent lighting to wash light across plazas and stairs. Uplight landscaping and architectural features to emphasize Group 1 and historical facilities.
19. Photometrics are required for all applications.
20. Manufacturers listed below are only provided to establish a baseline of equivalency among all applicable manufacturers.

C09.2. Light Fixture Types

Note: *Apply the below base-wide standards for Light Fixtures (products, materials and color). Then refer to the Appendix and apply any additional requirements specifically related to the Facility District in which the project is located.*

C09.2.1. Street Lighting

Applicable N/A

Number of base standards 2

Image Tool 250 x 188



Type: **Style 1**

Applies to: Group 1 Group 2 Group 3 Group 4 Other

Mfr: Varies

Color: Dark Bronze

Finish: Factory

Model #: Varies

Other: LED Lamp, Fluted Post, Decorative Lamp Globe

UFGS: N/A



Type: **Style 2**

Applies to: Group 1 Group 2 Group 3 Group 4 Other

Mfr: Streetworks

Color: Dark Bronze

Finish: Factory

Model #: OVB-LED

Other: LED Lamp, Plain Post

UFGS: N/A

C09.2.2. Parking Lot Lighting

Applicable N/A

Number of base standards 1

Image Tool 250 x 188



Type: **Style 1**

Applies to: Group 1 Group 2 Group 3 Group 4 Other

Mfr: McGraw-Edison

Color: Dark Anodized Bronze

Finish: Factory

Model #: TLM-B-LED

Other: LED Lamp, Plain Post

UFGS: N/A

C09.2.3. Lighted Bollards

Applicable N/A

Number of base standards 1

Image Tool 250 x 188



Type: **Lighted Round Dome Top**

Applies to: Group 1 Group 2 Group 3 Group 4 Other

Mfr: Lithonia Lighting Products

Color: Dark Bronze

Finish: Anodized aluminum

Model #: KBA

Other: Flared cone, 3000K LED Lamp. Follow manufacturer's recommendations for fixture base.

UFGS: N/A

C09.2.4. Sidewalk Lighting

Applicable N/A

C09.2.5. Walls / Stairs Lighting

Applicable N/A

C09.2.6. Other

Applicable N/A

D. FACILITIES EXTERIORS

Comply with Air Force Corporate Standards for Facilities Exteriors:

<http://afcfs.wbdg.org/facilities-exteriors/index.html>

D01. SUPPORTING THE MISSION

Comply with AF Corporate Standards for Supporting the Mission:

<http://afcfs.wbdg.org/facilities-exteriors/supporting-the-mission/index.html>

D02. SUSTAINABILITY

Comply with Air Force Corporate Standards for Sustainability:

<http://afcfs.wbdg.org/facilities-exteriors/supporting-the-mission/index.html>

D03. ARCHITECTURAL FEATURES

Comply with AF Corporate Standards for Facilities Exteriors:

<http://afcs.wbdg.org/facilities-exteriors/index.html>

Comply with AF Corporate Standards for Architectural Features:

<http://afcs.wbdg.org/facilities-exteriors/architectural-features/index.html>

Insert 3 photos for each facility group.

Image Tool 250 x 188

Group 1



Group 2



Group 3



Group 4



D03.1. Orientation, Massing and Scale

1. Compliment historic features on high visibility facilities without duplicating.
2. Emphasize horizontal proportions on Building elements.
3. Combining historic features with exposed skeletal frame is encouraged.
4. Rectangular elements are the standard for major building masses. Use clean, simple, contemporary forms and avoid curves or angular elements.
5. Develop a strong relationship between buildings and exterior spaces.
6. Articulate building facades to create areas of shade and shadow.
7. Use and coordinate shading devices with orientation and for function.

D03.2. Architectural Character

1. Preserve the historical architectural character of MacDill AFB and continue the rich military and cultural traditions through contemporary Florida Coastal design reflecting central Florida regionalism. Develop architectural features, materials and detailing appropriate for the Facility Group designation.
2. Group 1 and 2 Facilities in or adjacent to historical districts on the base should reflect the characteristics of adjacent buildings such as tile roofs and associated horizontal building elements.
3. For Group 4 facilities portray a strong Florida Coastal architectural character that is inherently residential and clearly distinguished from work environments. Integrate features such as broad overhangs, raised buildings, stucco walls, hipped roofs and screened porches using pastel colors and light accents that are subtly linked to the base's color scheme.
4. Maintain a level of quality in Facility Group 4, which is comparable to that found in adjacent public neighborhoods.
5. Construct Group 4 facilities elevated 11.5 feet above sea level on natural concrete piers to prevent flooding.
6. Incorporate traditional elements of the historic vernacular such as horizontal building expressions, stucco walls, louvered vents, pedimented porches with recessed entryways, and hipped roofs with projecting eaves. Combine these with select expressions of other existing styles on base characterized by quoins, modern horizontal forms, and expressed structure of pilasters and beams.
5. Develop architectural features, materials and detailing appropriate for the Facility Group designation. Refer to Building Entrances, Wall Systems and Roof Systems.
6. For new facilities design generally maintain consistency and visual unity in the character of the adjacent buildings through compatible architectural features: repeated use of similar forms such as roofs, and through recurring elements such as doors, windows, materials and colors.
7. Reinforce the campus environment and educational theme with a related architectural theme and site layout.
8. All facilities shall express sustainability through their orientation, massing, shape, form, materials, and detailing. Provide louvers, fins and other shading devices to control heat gain and glare and to and improve energy efficiency.
9. All facilities, regardless of location, will be built with a level of quality appropriate for the Facility Group number with low maintenance, sustainable materials prescribed in this IFS. Facilities in the remote locations should reflect consistent colors and characteristics following the Group number, but may have simplified detailing as approved by the BCE.
10. All ancillary structures shall be consistent with Community setting.

HISTORIC STRUCTURES (Facility Groups 1, 2 and 3)

General

1. Maintain buildings that have historical significance as focal points within the community giving evidence of the base's heritage. Preserve and protect the original condition of unique materials, construction methods, and detailing of these cultural assets whenever possible.
2. Preserve the forms, elements, and materials from Mediterranean Revival and Art Deco architecture as the hallmarks of the historic buildings at MacDill. Terra cotta tile roofs, stucco exterior walls, pedimented pilasters, with recessed entryways, arched openings, quoins, pilasters, and coping are unifying architectural themes.
2. Where possible protect, retain, and adapt historic properties rather than replace with new construction.
3. Design rehabilitation of historic properties consistent with the original character of the properties as outlined in the Secretary of the Interior Standards for Rehabilitation of Historic Properties.

Historic Properties

1. Design new construction to be compatible with adjacent historic properties in terms of massing, scale, and architecture to protect the integrity of those properties and their surroundings.
2. Consult with the State Historic Preservation Office and Advisory Council on Historic Properties when working on historic structures and follow procedures outlined in the National Historic Preservation Act.

Character

1. Work on or around historic structures is to follow the original intent as portrayed in drawings, writings, and / or archival photographs.
2. Avoid both the removal of historic features and the addition of false or conjectural historic elements into designs for rehabilitation of historic structures.
3. Preserve original historic materials, finishes, details, and architectural accouterments where possible.
4. Use accent lighting on desirable architectural features.

Wall Systems

1. Existing walls are cast-in-place concrete or stucco.
2. Repair and maintain architectural detailing as per historic precedent.
3. Use dark bronze storefront systems with clear glazing for doors and windows in facility 1-5, 11, 12, 27-35, 41, and 45.
4. Smaller residential character window and door openings are to be replaced with historic reproduction wood windows and doors painted white in facility 26, 401-405, 521-523.
5. Use translucent fiberglass panels for larger hangar-like windows and openings in hangar doors.

Roofing Systems

1. Roofs shall be terra cotta tile except for the hangar buildings, which are light gray rolled asphalt.
2. Tile color and profile to match existing.

Additions and Alterations

1. Additions and / or exterior alterations to historic structures are discouraged.
2. Restore and maintain the original intent as established by historic precedent where possible.
3. Colors are to follow established criteria for community buildings.

4. Carefully integrate into the character of the historic building while preserving the facility's original character and defining features.

D03.3. Details and Color

1. Use a Florida Coastal architecture palette of lighter tones (in response to the intense sunlight common of the region) and vivid hues (of the abundant flora and fauna). Generally apply a field color to match "Brazil Nut" and a lighter highlight "Seed Pearl." Apply the accent color to architectural features such as quoins, lintels, recessed panels, or horizontal banding.
2. Limit the palette of color among facilities to create greater continuity and compatibility. Design facilities to express an individual character while contributing to a sense of community.

General Paint Guidelines

1. Relate the level of architectural detailing to the Facility Group number.
2. Use only integrally colored materials as the predominant exterior building material; do not use materials that require field painting and ongoing maintenance.
3. Noncorrosive metals with factory applied color finishes are required.
4. Combine details and color with orientation, massing, scale and architectural character to maintain base compatibility.
5. Manufacturers listed below are only provided to establish a baseline of equivalency among all applicable manufacturers.
6. Use factory finished building products to reduce maintenance costs.
7. Consider individual paint schemes in context to the community.
8. Consistently apply paint colors to similar elements.
9. Use a single color per field, trim, or accent element on a facade.
10. Paint to visually enhance architectural details, reduce mass, and blend with the surrounding environment.
11. Keep paint schemes simple and do not "over detail" accents.
12. Do not create false architectural features such as quoins, lintels, bases, and capitals through painting.
13. Do not paint over factory finishes unless the existing colors do not comply.
14. Downplay service buildings by minimizing accent and trim painting.
15. Remove building lettering, signs, and other architectural elements of contrasting colors, prior to painting.
16. Do not use yellow hazard markings on buildings.
17. Painting insignias or other supergraphics on buildings or tanks is discouraged.
18. Paint wall mounted equipment to match adjacent surface.
19. Do not accent downspouts, vents, louvers, or gable ends.
20. Do not paint curbing.
21. Do not paint concrete elements and remove any existing paint on concrete Specific Paint Application.
22. Variations are subject to ACRB approval.

23. Paint wall surfaces Brazil Nut and accents, such as trim, quoins, and fascias Seed Pearl.
24. Painting individual building masses Worsted Tan as an accent to the primary color is acceptable to break up larger buildings.
25. Paint tanks and supporting equipment Seed Pearl.
26. Fascias on metal roofed buildings shall match standing seam metal roof color (PPG 5LR53975 - Terra Cotta).
27. Soffit color to match field color (normally Brazil Nut.)
28. Fascias on clay tile roof buildings shall be Seed Pearl.
29. Paint primary entry doors and frames Manor House. If painting a facility with black window frames - ICI #1674 Deep Onyx may be used with ACRB approval.
30. Paint secondary entry doors and frames Brazil Nut where no attention is to be drawn.
31. At facilities with multi-number of doors that face no apparent main entry (i.e. VQ, Dorms, etc.) paint doors and frames.

D03.3.1. Climate-based Data and Life-Cycle Cost-Effective Passive and Natural Design Strategies:

- Climate dominated by mechanical cooling
- Climate dominated by mechanical heating
- Climate with similar mechanical cooling / heating needs
- Climate with minimal mechanical cooling / heating needs

- Climate with high humidity
- Climate with moderate humidity
- Climate with low humidity

- High Solar Insolation
- Moderate Solar Insolation
- Low Solar Insolation

- Soils with High Thermal Conductivity
- Soils with Average Thermal Conductivity
- Soils with Low Thermal Conductivity

Other: Highly corrosive environment

Other:

Facility: Narrow buildings along E-W axis

Wall: Integral shading features and devices

Doors: Recessed

Windows: Limit non-shaded windows / maximize windows on south façades with shading

Roof: High to medium albedo, minimal to moderate slope

Structure: (exposed) Non-ferrous metals or concrete

MEP: Ground-source and solar photovoltaic following LCCA

Other: Internal thermal mass walls may be used following LCCA

Other:

Note: Apply the below base-wide standards for Architectural Features (products, materials and color). Then refer to the Appendix and apply any additional requirements specifically related to the Facility District in which the project is located.

D03.3.2. Natural Ventilation System

Applicable N/A

D03.3.3. Thermal Mass

Applicable N/A Number of base standards 1

Image Tool 250 x 188

Type: **Interior Masonry Wall – Stucco over CMU**

Applies to: Group 1 Group 2 Group 3 Group 4 Other

Mfr: Local TBD

Color: Florida Coastal Palette (Stucco)

Finish: Light texture

Model #: Two-coat cementitious system

Other: Section 09 24 23 Cement Stucco

UFGS: Section 04 20 00 Unit Masonry



D03.3.4. Thermal Shading

Applicable N/A

Number of base standards 2

Image Tool 250 x 188



Type: **Style 1 Wall Devices**

Applies to: Group 1 Group 2 Group 3 Group 4 Other

Mfr: Kawneer (or equivalent)

Color: Medium Bronze

Finish: Factory, to match frames

Model #: Louver

Other: Shading devices may be attached to frames
<http://www.wbdg.org/FFC/DOD/UFGS/UFGS%2008%2041%2013.pdf>

UFGS: Section 08 41 13 Aluminum-Framed Entrances and Storefronts

Type: **Thermal Shading - Wall Devices**

Applies to: Group 1 Group 2 Group 3 Group 4 Other

Mfr: Steelcraft (or equivalent)

Color: Medium Bronze

Finish: Factory, to match frames

Model #: Louver, powder coated

Other: Shading devices may be attached to frames
Shading devices may be attached to structure
<http://www.wbdg.org/FFC/DOD/UFGS/UFGS%2008%2011%2013.pdf>

UFGS: Section 08 11 13 Steel Doors and Frames

D03.3.5. Renewable Heating/Cooling

Applicable N/A

D03.3.6. Solar Photovoltaic System

Applicable N/A

D03.3.7. Solar Thermal System

Applicable N/A

D04. BUILDING ENTRANCES

Comply with AF Corporate Standards for Facilities Exteriors:

<http://afcs.wbdg.org/facilities-exterior/index.html>

Comply with AF Corporate Standards for Building Entrances:

<http://afcs.wbdg.org/facilities-exterior/building-entrances/index.html>

Insert 3 photos for each facility group.

Image Tool 250 x 188

Group 1



Group 2



Group 3



Group 4



D04.1. Primary Entrances

1. Design primary entrances as a transitional element from exterior to interior and as a focal point in the primary facade. Express the Facility Group designation through the size and architectural detailing of the entrance structure.
2. Recess entries to distinguish them on the facade and to provide shade and protection from the elements.
3. Create enclosed vestibules and weather protected transition spaces at entrances.
4. Use open gabled roof elements at high visibility entries.
5. Courtyards and / or entry plazas with integrated planters may be incorporated into the design of Group 1 facilities.
6. Use accent pavers in approach walkway or at entry plaza feature.
7. Trellises may be integrated into the design of high-visibility Group 1 and 2 facilities to create areas of shade and interest. Construct trellises of low maintenance, materials. Incorporate vines or other landscape materials in the design.
8. Arcades and / or loggias as an extension of the building entrance may be used in Group 1 facilities. Integrate with the building's design, style, form, and materials.
9. Light colored canvas canopies and stand-alone pavilion entries are allowed with ACRB approval.
10. Locate magazine racks and other similar elements out of view to avoid visual clutter.
11. Provide vestibules at entries in Groups 1 and 2 unless used infrequently or serving unconditioned space following ASHRAE 90.1.
12. Fully integrate all elements including the design of handicap ramps in the overall design of the primary entrance in an organized uncluttered appearance.
13. Install paved transitional spaces sized for the building function and occupancy.
14. Integrate handrails with facility design. Use dark bronze, pre-finished metal handrails. Terra cotta colored handrails are allowed as an accent with ACRB approval.
15. Install appropriate lighting and site furniture following ATFP and IFS.
16. Provide porte cocheres or covered drop-offs when justified for lodging and medical facilities; do not use for prestige or architectural accents.
17. Design Group 4 entrances and porches to express the unique coastal climate while promoting outdoor activities and community interaction. Emphasize the public nature of the primary entry by creating a porch for neighborhood or family interaction. Provide limited opportunities for personal expression at the front porch with furnishings, planters, flags, etc.

D04.2. Secondary Entrances

1. Provide vestibules at entries in Groups 1 and 2 unless used infrequently or serving unconditioned space following ASHRAE 90.1
2. Reflect the character of the primary entrance to a lesser extent with a smaller scale.
3. Recess entries to provide areas of shade and weather protection.
4. Provide a small courtyard or seating area near secondary entries
5. Integrate service and egress doors and loading areas with the building design by matching the materials and detailing and reflect the overall quality of the facility.
6. Incorporate egress structures such as stair towers into the facility design.

7. Canopies may be used for service and loading areas; weather protection beyond weatherstripping is not required at doors used only for life safety egress.
8. Group 4 secondary entrances shall include a stoop or patio at when located at grade. The use of bug screens to enclose porches is encouraged.
9. Develop building massing and orientation to minimize the appearance of service and loading areas; physically and visually separate these from primary entrances. Use landscaping and screen walls to screen and separate loading docks.
10. Loading areas must be organized, orderly and have an uncluttered appearance.
11. Provide unobtrusive service entrances that are physically and visually separated from primary and secondary entrances.
12. Minimize visual impact of exit-only doors. Do not use canopies at emergency egress doorways.

D05. WALL SYSTEMS

Comply with AF Corporate Standards for Facilities Exteriors:

<http://afcs.wbdg.org/facilities-exteriors/index.html>

Comply with AF Corporate Standards for Doors and Windows:

<http://afcs.wbdg.org/facilities-exteriors/wall-systems/index.html>

Comply with AFCFS Recommended Materials:

<http://afcs.wbdg.org/facilities-exteriors/wall-systems/materials/index.html>

Insert 3 photos for each facility group.

Image Tool 250 x 188

Group 1



Group 2



Group 3



Group 4



D05.1. Hierarchy of Materials

1. Select wall systems based on the Facility Group number, operational functionality and the materials used on adjacent structures. Generally maintain consistency with adjacent buildings and limit the base-wide application of materials and color to reduce visual clutter caused by too much diversity.
2. Group 1 facilities may have more refined detailing than Group 2 and Group 2 may have more definition than Group 3.
3. Group 1 and 2 facilities can be stucco (on concrete block) or precast concrete. Group 3 storage/industrial facilities may use pre-finished colored metal panels. Group 3 administration facilities such comply with group 3 standards unless they are located in remote areas of the base.
4. Group 4 shall be either stucco, or horizontal siding with varied color schemes to add individuality and reduce the institutional appearance of monochromatic color schemes. Alternate color schemes to create diversity along the streetscape. Use trim and accent colors as approved by the BCE. Do not paint exposed concrete piers or foundations. Paint existing housing (not historic) to match new housing color schemes.
5. Use only base standard materials and colors. Minimize surfaces requiring painting and cleaning.
6. Use integral colored materials and factory finished building products to reduce maintenance.
7. Use only corrosion-resistant, factory finished fasteners and exterior metals except for Historic preservation project
8. Brazil Nut, sand finish stucco walls with Seed Pearl highlights and details are the standard.
9. Pebble colored split-face block is acceptable as an accent on a limited basis.
10. Use sealant to match or blend with surface materials and color.
11. High-visibility facilities shall demonstrate a greater application of historic detailing.
12. Limit pre-finished metal wall panels to larger industrial buildings.
13. Use integrally colored materials and factory-finished metals. Do not paint concrete block.
14. Manufacturers listed below are only provided to establish a baseline of equivalent among all applicable manufacturers.

D05.2. Layout, Organization and Durability

1. Architectural accents such as quoins, horizontal banding, medallions, friezes, vaulted openings, recessed areas or other adapted detailing are encouraged on high-visibility facilities. Accents shall be factory finished colors.
2. Use accents such as medallions, stucco joints, patterns, etc. to highlight entries and to enliven otherwise featureless facades. Organize wall components including doors, windows, accents, shading devices, control joints, etc., to provide an ordered, professional appearance.
3. Use expansion joints, reveals, recessed panels, and expressed pilasters to break up flat facades and add visual interest.
4. Break up facades with windows, recessed panels, horizontal banding, or by expressing the skeletal structure.
5. Integrate shading devices into the overall composition of the wall. Integrate fixed shading devices as at all exterior glazing exposed to summer UV heat gain as a passive design measure to reduce energy use. Ensure adequate shading at west entrances. Deciduous trees may be used for shading.
6. Provide appropriate transitions between dissimilar materials to mitigate effects of thermal expansion and galvanic action.
7. All joint sealants shall be slightly darker than adjacent surfaces.

8. Materials requiring regular maintenance are not permitted; do not use exposed structural steel or other materials that require painting.
9. Refer to C07.2.16. Screen Walls for materials and colors of freestanding walls.

D05.3. Equipment, Vents and Devices

1. Arrange all mechanical, electrical, fire alarm, lightning protection and other system components to create an orderly appearance that integrates with the wall system.
2. Do not expose conduits, cables, piping, lightning protection components, etc. on exterior walls; if unavoidable in renovations, finish these elements to match the adjacent wall surface.
3. Avoid visual clutter and where surface-mounted elements are required they shall match the wall color.

D05.4 Wall Systems Materials

Facility Group 1 wall materials shall be as follows.

Primary: Stucco on concrete block or cast-in-place conc.
 Secondary: Architectural Precast
 Accent: Optional: Metal Panels

Facility Group 3 wall materials shall be as follows.

Primary: Insulated metal panels (prefinished)
 Secondary: Ribbed Metal Sheeting (prefinished)
 Accent: Stucco on concrete block or cast-in-place conc.

Facility Group 2 wall materials shall be as follows.

Primary: stucco on concrete block or cast-in-place conc.
 Secondary: Architectural Precast
 Accent: Optional: Metal Panels

Facility Group 4 wall materials shall be as follows.

Primary: Fiber Cement Siding
 Secondary: Fiber Cement Siding, Trim Boards
 Accent: Concrete or Brick Foundation Cladding

Note: Apply the below base-wide standards for Wall Systems (products, materials and color). Then refer to the Appendix and apply any additional requirements specifically related to the Facility District in which the project is located.

D05.4.1. Flat Metal Panels

Applicable N/A

D05.4.2. Brick Veneer

Applicable N/A

D05.4.3. Architectural Precast

Applicable N/A Number of base standards 1

Image Tool 250 x 188



Type: **Architectural Precast**

Applies to: Group 1 Group 2 Group 3 Group 4 Other

Mfr: Local TBD

Model #: Unit castings

Color: Light beige

Finish: Smooth casting

Other: Very light texture

UFGS: Section 03 45 00 Precast Architectural Concrete:
<http://www.wbdg.org/FFC/DOD/UFGS/UFGS 03 45 00.pdf>

D05.4.4. Stucco Over Sheathing

Applicable N/A Number of base standards 1

Image Tool 250 x 188



Type: **Cementitious Stucco with Synthetic Finish**

Applies to: Group 1 Group 2 Group 3 Group 4 Other

Mfr: Sto

Model #: StoQuik Silver Drain Sto Emerald Coat

Color: Medium beige

Finish: Sand

Other: N/A

UFGS: Section 09 24 23 Cement Stucco:
<http://www.wbdg.org/FFC/DOD/UFGS/UFGS 09 24 23.pdf>

D05.4.5. Curtain Wall

Applicable N/A

D05.4.6. Cast-In-Place Concrete

Applicable N/A

D05.4.7. Tilt-Up Concrete

Applicable N/A

D05.4.8. Ribbed Metal Sheeting

Applicable N/A Number of base standards 1

Image Tool 250 x 188



Type: **Style 1**

Applies to: Group 1 Group 2 Group 3 Group 4 Other

Mfr: Berridge

Model #: R-Panel or profile approved by BCE

Color: Parchment or as approved by BCE

Finish: Factory

Other: 0.032 Aluminum, Florida Product Approval

UFGS: Section 07 42 13 Metal Wall Panels:
<http://www.wbdg.org/FFC/DOD/UFGS/UFGS 07 42 13.pdf>

D05.4.9. EFIS

Applicable N/A

D05.4.10. GRFC

Applicable N/A

D05.4.11. Concrete Block

Applicable N/A

D05.4.12. Fiber Cement Siding

Applicable N/A

Number of base standards 1

Image Tool 250 x 188



Type: **Cement Board Siding**

Applies to: Group 1 Group 2 Group 3 Group 4 Other

Mfr: James Hardie Building Products, Inc.

Model #: Horizontal Lap Siding, Shingle Siding

Color: Earth tones

Finish: Wood texture

Other: Hardie Plank, Hardie Shingle

UFGS: SECTION 074646 Fiber Cement Siding:
(Not Available on UFGS)

D05.4.13. Other

Applicable N/A

D06. DOORS AND WINDOWS

Comply with AF Corporate Standards for Facilities Exteriors:

<http://afcs.wbdg.org/facilities-exteriors/index.html>

Comply with AF Corporate Standards for Doors and Windows:

<http://afcs.wbdg.org/facilities-exteriors/doors-and-windows/index.html>

Comply with AFCFS Recommended Materials:

<http://afcs.wbdg.org/facilities-exteriors/doors-and-windows/materials/index.html>

Insert 3 photos for each facility group.

Image Tool 250 x 188

Group 1



Group 2



Group 3



Group 4



D06.1. Types

Doors, Exterior

1. Main entrances to facilities shall be designed to be readily discernible.
2. Primary entrance doors are typically aluminum and glass, dark bronze anodized frames. Typically, use dark bronze storefront systems with clear glazing for doors and windows in facility 1-5, 11, 12, 27-35, 41, and 45. Smaller residential character door and window openings are to be replaced with historic reproduction wood windows and doors painted white in facility 26, 401-405, and 521-523.
3. Automatic doors are allowed only where functionally necessary.
4. All exterior doors shall be protected from the direct effects of weather to the extent reasonable. The main entrance(s) shall generally include a building canopy that is part of the building architecture for new facilities and major renovations.
5. Typically, the aluminum and glass exterior door BOD shall be the Kawneer 350IR, blast tested to 5.8 psi, wet glazed, insulated, bronzed, 3-inch x 1/2-inch cross rail., thermally broken frames.
6. All exterior doors must comply with Antiterrorism/Force Protection (ATFP) requirements. See UFC 4-010-01, DoD Minimum Antiterrorism Standards for Buildings, includes Change 1.
7. All exterior doors are expected to also comply with Miami-Dade Notice of Acceptance (NOA) and pass large and small projectile testing. ATFP requirements may override NOA requirements where no other options exist.
8. Utility and emergency egress doors shall match the wall color.
9. Typically, exterior steel doors and frames BOD shall be as manufactured by Steelcraft. Slabs to be 16 gauge, cold rolled G60 galvanized steel, seamless with appropriate foamed insulated core. Doors shall be factory primed/ANSI a224.1. The steel frames BOD shall be as manufactured by Steelcraft, 16 gauge, G60 galvanized steel, primed for jobsite finishing.
10. Facility Group 4 shall use vinyl or vinyl-clad wood windows in white for all applications. Do not paint windows and doors. Provide hurricane protection at openings with laminated glass or operable shutters.
11. Group 4 shall use factory finished aluminium doors at all entry points. Incorporate glazing in all primary entry doors.

Windows, Exterior

1. Fenestration must meet current code, Miami-Dade Notice of Acceptance (NOA), and UFC 4-010-01, "Anti-terrorism Force Protection" (ATFP) requirements per UFC 3-10-01, "Architecture", UON.
2. Generally, dark bronze Class I anodized, tinted, insulated, single hung windows, with thermally broken frames (exterior glazed muntins and screens required where operable windows are utilized).
3. All windows shall be double paned with tinting.
4. Minimum performance requirements for aluminum windows, terminology, and standards of performance, fabrication, and workmanship are those specified and recommended in American Architectural Manufacturers Association (AAMA) / National Wood, Window, and Door Association (NWWDA) 101/i.s.2 - 97 and applicable general recommendations published by AAMA. Conform to more stringent requirements as indicated in specific project documents.
5. Historic windows shall be coordinated with CE and SHPO.
6. Blast Resistance:
 - a. ASTM F1642-04: Standard test method for glazing and glazing systems subject to air blast loadings: Minimal hazard response at a 4 psi pressure, 30 psi-msec impulse, blast load.
 - b. US General Services Administration (GSA) test protocol GSA-TS01-2003: Standard test method for glazing and window systems subject to dynamic overpressure loadings: Level 2 protection at a 4 psi pressure, 30 psi-msec impulse, blast load.

c. DOD AFTP construction standards, UFC 4-010-01: Medium level of protection at a 4 psi pressure, 30 psi-msec impulse, blast load.

7. New window installation shall require shop drawings that are engineered, signed, and sealed by a Florida registered structural engineer. The drawings should show anchors, anchor holes in frames, hardware, operators, and other components as appropriate if not included in manufacturer's standard data.
8. Adjacent joint sealants should be slightly darker than the frame color.
9. Manufacturers listed below are only provided to establish a baseline of equivalency among all applicable manufacturers.

Doors and Windows, Interior

1. Please refer to Section E05.1. Doors and Windows and Frames Materials for interiors.

D06.2. Layout and Geometry

1. Visually and functionally compose openings in walls for the climate-specific exposure.
2. Consistently use opening type, size, placement, mullion pattern, and color to reinforce the overall architectural design.
3. Openings shall augment interior lighting and space conditioning needs.
4. Protect against vandalism, intrusion and coordinate sound ratings.

D06.3. Glazing and Shading

1. Tinted, energy-efficient, low-e, double-pane glazing is encouraged; provide triple-pane glazing in extreme environments.
2. Glazing color shall follow Installation Facilities Standards (IFS).
3. Translucent wall panels may be integrated into wall systems.
4. Do not use mirrored glazing.
5. Fully integrate applicable shading designs for overhangs, louvers, light shelves and grilles.
6. Where appropriate, install window screens to take advantage of natural ventilation.

D06.4. Hardware

Doors, Exterior

1. Reinforced at all hardware locations with galvanized steel: 7 gauge at hinges; 14 gauge at strike. Kerfed frames for gasketed sound and air infiltration control. Hinges must be heavy duty, 5 knuckle, stainless steel, base metal and finish with NRP. Best hardware: 45H Series (full mortise); interchangeable cores; stainless steel base metal lever style 14; escutcheon J; compatible strike; 630 satin stainless steel.
2. Hardware must be able to accept the Best cores that are MacDill standard requirements. All proposed hardware schedules must be reviewed by the base locksmith for compliance as well as keying.

Doors, Interior

1. Please refer to Section E05.1. Doors and Windows and Frames Materials for interiors.

D06.5. Doors and Windows Materials

Note: Apply the below *base-wide standards* for Doors and Windows (products, materials and color). Then refer to the Appendix and apply any additional requirements specifically related to the Facility District in which the project is located.

D06.5.1. Anodized Aluminum

Applicable N/A

Number of base standards 1

Image Tool 250 x 188



Type: **Anodized Aluminum Doors, Windows and Frames**

Applies to: Group 1 Group 2 Group 3 Group 4 Other

Mfr: Kawneer (or equivalent)

Color: Dark bronze or black anodized

Finish: Matte

Model #: 2x4

Other: Provide thermally broken frames

UGFS: Section 08 41 13 Aluminum-Framed Entrances and Storefronts:
<http://www.wbdg.org/FFC/DOD/UGFS/UGFS 08 41 13.pdf>

D06.5.2. Hollow Metal

Applicable N/A

D06.5.3. Aluminum-clad Wood

Applicable N/A

D06.5.4. Other

Applicable N/A

Number of base standards 1

Image Tool 250 x 188

Type: **Vinyl Residential**

Applies to: Group 1 Group 2 Group 3 Group 4 Other

Mfr: TBD

Color: White or as determined by the BCE

Finish: Factory, satin

Model #: Double hung or casement

Other: N/A

UFGS: N/A



D07. ROOF SYSTEMS

Comply with AF Corporate Standards for Facilities Exteriors:

<http://afcs.wbdg.org/facilities-exteriors/index.html>

Comply with AF Corporate Standards for Roof Systems:

<http://afcs.wbdg.org/facilities-exteriors/roof-systems/index.html>

Comply with AFCFS Recommended Materials:

<http://afcs.wbdg.org/facilities-exteriors/roof-systems/materials/index.html>

Insert 3 photos for each facility group.

Image Tool 250 x 188

Group 1



Group 2



Group 3



Group 4



D07.1. Roof Type and Form

1. Design the roof form and select material and color based on the Facility Group number, operational functionality and location on the base. Develop sloped roof systems as prominent architectural features.
2. Group 1 and 2: Terra cotta colored standing seam metal hipped roofs are the standard. Terra cotta tile hipped roofs are allowed on high-visibility facilities with ACRB approval. In some cases shingle or flat roofs may be required to meet the type of building, existing construction, or area location of the building.
3. Group 3: Terra cotta colored standing seam metal hipped roofs are the standard for administration buildings. Membrane roofing with a minimum slope of 1/2 : 12 for low-sloped roofs may be used for large storage/industrial facilities.
4. Group 4 facilities shall have gabled or hipped roofs with either tile or composite shingles, sloped between 4:12 and 6:12. Dormers or louvered Dutch hips may be used. Alternate established color schemes to increase visual diversity. Use factory finished, corrosion resistant materials for all fascias, gutters, downspouts, and soffits to match the trim color.
5. Use proven, cost-effective roof systems with high durability, weather resistance, and low maintenance that are compatible with Installation Facilities Standards (IFS) and requirements for the designated Facility Group.
6. Break up overall roof massing on larger structures.
7. Generally match the roof type and form of existing adjacent facilities in new construction.
8. Provide screens for roof-mounted appendages and equipment of the same materials, which are used predominantly in the building's roof systems.
9. Roof translucent panels are permitted for storage/industrial facilities.
10. Roof eaves shall extend beyond the exterior wall for roof drainage and shading. Provide overhangs for shading in response to local climatic conditions, sized and proportioned to the height of the facility and to the window openings being shaded.
11. South-facing eaves shall coordinate with adjacent wall-mounted shading devices.
12. The color, shape and slope of the eave and soffit shall be compatible with adjacent facilities.
13. Keep roofs uncluttered and minimize penetrations.
14. Diminish massive roofs into coordinated smaller consistent with adjacent facilities; avoid random, arbitrary changes.
15. Roofs shall be maintained for the life of the system and replaced in accordance with UFC 3-110-04 and AFI 32-1051.
16. A warranty is required on all new roofs.
17. Manufacturers listed below are only provided to establish a baseline of equivalent among all applicable manufacturers.

D07.2. Roof Slope

1. Use hipped roofs with pitches between 3:12 and 5:12 as the primary building form for all facility types.
2. Low-sloped roofs are only allowed for larger structures in combination with hipped roofs, or to match existing conditions on add / alt projects
3. Low-sloped roofs are allowed for larger structures or to match existing conditions on renovation projects. Minimal-sloped roofs may also be used for Group 3 facilities in high-visibility areas
4. Open gabled elements may be used to accent entries.

5. Use large overhangs between 2 feet and 3 feet proportional to the size and height of the building.
6. Minimize thickness of roof edge to express a thin edge.
7. Ensure adequate drainage, and connect to the subsurface rain collection system where available.
8. Provide roof slopes to accommodate solar photovoltaic, solar thermal, passive systems and daylighting when applicable following UFC 1-200-02.
9. Provide underlayments as required for the roofing type as directed by the UFC.

D07.3. Parapets and Copings

1. Extend wall materials vertically above the roof line and provide metal copings to match the wall. Ensure copings are properly flashed and detailed to avoid roof leaks.

D07.4. Color and Reflectivity

1. Sloped roofs in Groups 1, 2, and 3 shall be Terra cotta colored to match adjacent facilities and follow requirements of IFS.
2. Sloped roofs in Group 4 shall be match adjacent facilities and follow requirements of IFS.
3. All minimal-slope membrane roofs shall use only use high-albedo, high reflectivity color to help decrease the temperature around the buildings and minimize damage to human and wildlife habitat.
4. Comply with UFC 3-110-03 and ASHRAE 90.1 for Solar Reflectance Index (SRI) and thermal requirements.
5. All roof flashing shall match the color of the predominant background material.

D07.5. Gutters, Downspouts, Scuppers, Drains

1. Generally, the depth of fascias shall be no larger than 8 inches.
2. Fascia finish shall match the roof color when occurring with metal roofing.
3. Flashing color shall match roof color.
4. Stepped flashing at the intersection of roofs and walls shall match wall color.
5. Gutters on sloped roofs shall be factory finished to match the roof color.
6. Minimize the negative visual impact of downspouts by coordinating placement with architectural features
7. All sloped roofs shall use gutters and downspouts. Gutters shall be outside the fascia.
8. Internal roof drainage systems are not permitted in new construction. Minimal-sloped roofs shall be sloped to drain to the building perimeter through scuppers into downspouts.
9. Size the roof drainage system per IBC and SMACNA for the region.
10. Use scuppers as required in parapet walls. Arrange scuppers in an orderly manner consistent with other elements of the wall system.
11. When open scuppers are connected to downspouts, provide transitions consistent with adjacent facilities.
12. Integrate downspouts with the architectural details of the wall system and arrange in an orderly, non-prominent appearance. Generally blend downspouts with the color of the wall (not contrasting it).

13. Fabricate downspouts from non-corrosive materials such as aluminum or zinc-coated steel. Provide powder-coated finishes in medium bronze.
14. All downspouts shall be solid.
15. Provide angled transitional pieces for downspouts to fit closely against the wall for their entire length.
16. Coordinate locations of downspouts to conceal control joints in masonry walls when possible.
17. Place downspouts away from building entries. Water discharged should not run across sidewalks.

D07.6. Roof Vents and Elements

1. Minimize and consolidate roof penetrations into a single, inconspicuous point whenever possible.
2. On sloped roofs clad pipe penetrations to match the roofing material.
3. Avoid the use of rooftop mechanical equipment, however for renovations and unavoidable configurations ensure units are screened.
4. Provide access points and service routes to equipment that protect the roof.
5. Screen all large vents.
6. Ensure attic spaces are properly vented at ridges and soffits.
7. Match roof color for all exposed equipment and vents.
8. Avoid roof-mounted antenna systems.
9. Arrange Lightning Protection Systems (LPS) components in an ordered, uncluttered, inconspicuous appearance and integrated into the organization of the roof and wall systems.
10. Ensure that LPS roof mounting systems are approved by the roofing manufacturer.
11. Additions to a roof shall not interfere with LPS or other rooftop systems that may be required.
12. Permanent fall protection shall be included with any addition to a roof with a slope above 3:12 per UFC 3-110-03 to a roof with a slope above 3:12 per UFC 3-110-03.

D07.7. Clerestories and Skylights

1. Clerestories and skylights are permitted in Group 1 facilities. These are allowed in Group 3 facilities only when serving passive systems and are justifiable by life-cycle analysis.
2. Clerestories are preferred to skylights to avoid roof penetrations. Skylights, when permitted, must be simple in shape and integrated with the roof system to eliminate leakage.
3. Design clerestories and skylights using the same principles for seasonal shading that are required for walls and roof overhangs.
4. Translucent panel systems are preferred in clerestory applications due to lack of window cleaning.
5. Clerestories and skylights must comply with UFC 4-10-01.

D07.8. Vegetated Roof

1. Not applicable.

D07.9. Roof Systems Materials

Note: Apply the below base-wide standards for Roof Systems (products, materials and color). Then refer to the Appendix and apply any additional requirements specifically related to the Facility District in which the project is located.

D07.9.1. Standing Seam Metal

Applicable N/A Number of base standards 1

Image Tool 250 x 188



Type: **Mechanically Seamed Metal Roofing System**

Applies to: Group 1 Group 2 Group 3 Group 4 Other

Mfr: Berridge Manufacturing Company

Color: Terra Cotta

Finish: Kynar 500

Model #: Double-Lock Zee-Lock

Other: Miami-Dade Approved
Florida Product Approval
2" High Seam sidelap, 16" exposure

UFGS: Section 07 61 14 Steel Standing Seam Roofing
<http://www.wbdg.org/FFC/DOD/UFGS/UFGS 07 61 14.00 20.pdf>

D07.9.2. Membrane Single-ply

Applicable N/A Number of base standards 1

Image Tool 250 x 188



Type: **Single-Ply Membrane**

Applies to: Group 1 Group 2 Group 3 Group 4 Other

Mfr: Suprema Soprastar or equal

Color: White

Finish: Smooth

Model #: TPO single-ply, "flat" minimal slope

Other: White granulated top ply with an aged solar reflective index of 86

UFGS: Section 07 53 23 Ethylene-Propylene-Diene-Monomer Roofing
<http://www.wbdg.org/FFC/DOD/UFGS/UFGS 07 53 23.pdf>
Section 07 54 50 TPO Thermoplastic Single-Ply Roofing
(Not Available on UFGS)

D07.9.3. Built-up Multi-ply

Applicable N/A

D07.9.4. Concrete Tile

Applicable N/A

D07.9.5. Clay Tile

Applicable N/A

Number of base standards 1

Image Tool 250 x 188



Type: **Straight Barrel Mission Tile**

Applies to: Group 1 Group 2 Group 3 Group 4 Other

Mfr: Ludowici

Color: Clay Red Blend, Summer Rose Blend, Santiago Rose Blend

Finish: Heavy Machine Score (or to Match Existing)

Model #: 14-1/4" Mission Tile (or to Match Existing)

Other: Miami-Dade NOA, Florida Product Approval, ASTM C1167 Grade 1 Roof Tile with Water Absorption less than 2%, Class A Fire Rated

UFGS: Section 07 32 13 Clay Roof Tiles
(Not Available on UFGS)

Section 07 32 14 Clay Tile Roofing Replacement or Repair
http://www.wbdg.org/FFC/DOD/UFGS/UFGS_07_32_14.pdf

D07.9.6. Slate Shingles

Applicable N/A

D07.9.7. Vegetated System

Applicable N/A

D07.9.8. Ribbed Metal Sheeting

Applicable N/A

D07.9.9. Composite Shingles

Applicable N/A

Number of base standards 1

Image Tool 250 x 188



Type: **Asphalt Shingles**

Applies to: Group 1 Group 2 Group 3 Group 4 Other

Mfr: GAF

Color: Sunset Brick, Weathered Wood, Driftwood

Finish: Factory

Model #: Architectural profile

Other: N/A

UFGS: Section 07 31 13 Glass-fiber-reinforced Asphalt Shingles
<http://www.wbdg.org/FFC/DOD/UFGS/UFGS 07 31 13.pdf>

D07.9.10. Other

Applicable N/A

D08. STRUCTURAL SYSTEMS

Comply with AF Corporate Standards for Facilities Exteriors:

<http://afcs.wbdg.org/facilities-exteriors/index.html>

Comply with AF Corporate Standards for Structural Systems:

<http://afcs.wbdg.org/facilities-exteriors/structural-systems/index.html>

Comply with AFCFS Recommended Materials:

<http://afcs.wbdg.org/facilities-exteriors/structural-systems/materials/index.html>

Insert 3 photos for each facility group.

Image Tool 250 x 188

Group 1



Group 2



Group 3



Group 4



D08.1. Systems and Layouts

1. Pre-engineered structural steel framing may be used for Groups 1, 2 and 3 facilities; Installation-appropriate thermal envelopes, materials and detailing are required.
2. Select economical structural systems that integrate roof and wall systems.
3. Narrow buildings 60' or less in width with column-free interiors are preferred for office, administrative and personnel spaces; when interior columns are required optimize the structural grid layout for open-plan arrangements.
4. Fully coordinate structural grids with exterior window systems to align columns with window frames or wall systems.
5. When structure is exposed provide an organized appearance and coordinate with mechanical, electrical, plumbing, fire protection, information technology, and communications systems.
6. Limit the use of specialty systems (such as space frames, vaults or domes) and of structure as a visual feature.
7. Cost-effectively design interior bearing walls as thermal mass.
8. Manufacturers listed below are only provided to establish a baseline of equivalency among all applicable manufacturers.

D08.2. Structural Systems Materials

Note: Apply the below *base-wide standards* for Structural Systems (products, materials and color). Then refer to the Appendix and apply any additional requirements specifically related to the Facility District in which the project is located.

D08.2.1. Concrete

Applicable N/A

Number of base standards 1

Image Tool 250 x 188



Type: **Concrete Framing**

Applies to: Group 1 Group 2 Group 3 Group 4 Other

Mfr: Custom

Color: Natural Gray

Finish: Light texture

Model #: Post and beam, waffle slab

Other: N/A

UFGS: Section 03 30 53 Miscellaneous Cast-In-Place Concrete
<http://www.wbdg.org/FFC/DOD/UFGS/UFGS 03 30 53.pdf>
Section 03 33 00 Cast-In-Place Architectural Concrete
<http://www.wbdg.org/FFC/DOD/UFGS/UFGS 03 33 00.pdf>
Section 03 47 13 Tilt-Up Concrete
<http://www.wbdg.org/FFC/DOD/UFGS/UFGS 03 47 13.pdf>

D08.2.2. Insulated Concrete Forming (ICF)

Applicable N/A

D08.2.3. Steel

Applicable N/A

Number of base standards 1

Image Tool 250 x 188



Type: **Rigid Framing**

Applies to: Group 1 Group 2 Group 3 Group 4 Other

Mfr: US Steel

Color: Hot-dipped galvanized metal

Finish: Matte

Model #: Structural steel shapes

Other: N/A

UFGS: Section 05 12 00 Structural Steel

http://www.wbdg.org/FFC/DOD/UFGS/UFGS_05_12_00.pdf

D08.2.4. Pre-Engineered Steel

Applicable N/A

Number of base standards 1

Image Tool 250 x 188



Type: **Moment Frame**

Applies to: Group 1 Group 2 Group 3 Group 4 Other

Mfr: Local TBD

Color: Hot-dipped galvanized metal

Finish: Matte

Model #: Moment Frame

Other: Draped insulation may be used behind wall systems. Deflection criteria must follow IBC.

UFGS: Section 13 12 00 Steel Building Systems

(Not Available on UFGS)

Section 13 34 19 Metal Building Systems

http://www.wbdg.org/FFC/DOD/UFGS/UFGS_13_34_19.pdf

D08.2.5. Masonry

Applicable N/A

D08.2.6. Heavy Timber

Applicable N/A

D08.2.7. Light-gauge Steel

Applicable N/A Number of base standards 1

Image Tool 250 x 188



Type: **Light Gauge Steel Framing**

Applies to: Group 1 Group 2 Group 3 Group 4 Other

Mfr: Local TBD

Color: Hot-dipped galvanized metal

Finish: Matte

Model #: Standard Structural Shapes

Other: N/A

UFGS: Section 05 45 00 Light Gauge Steel Framing System
(Not Available on UFGS)

D08.2.8. Lumber Framing

Applicable N/A

D08.2.9. Other

Applicable N/A

D09. MECHANICAL, ELECTRICAL AND PLUMBING

Comply with AF Corporate Standards for Facilities Exteriors:

<http://afcs.wbdg.org/facilities-exteriors/index.html>

Comply with AF Corporate Standards for Mechanical, Electrical and Plumbing:

<http://afcs.wbdg.org/facilities-exteriors/mechanical-electrical-and-plumbing/index.html>

Insert 3 photos for each facility group.

Image Tool 250 x 188

Group 1



Group 2



Group 3



Group 4



D09.1. Passive and Active Systems

1. Solar domestic hot water systems are required when life cycle cost effective for the climate.
2. Integrate shading into building exteriors to reduce solar heat gain during hot seasons.

D09.2. Functionality and Efficiency

HVAC

1. Avoid placing HVAC units and any other mechanical equipment on top of roofs (i.e., no penetrations through roofs) due to problems with roof leaks, accessibility, and maintainability requirements. If rooftop equipment is necessary, use existing roof warranty holder to perform the work, if applicable.
2. Place all utilities underground, if possible, especially laterals to buildings. All exposed piping, insulation, and supports must be painted to match the structure. Protective sleeves must be used if pipe or insulation must be run above ground.
3. Use double-walled, pre-insulated pipe for buried, chilled water piping between the mechanical room and the chiller.
4. Obtain permits for air pollution emissions for boiler and incinerator installation.
5. UFC 4-010-01, "DOD Minimum Antiterrorism Standards for Buildings" requires emergency air intake shutoffs and that building air intake be located 10-feet or greater above the adjacent ground surface.
6. Fully coordinate mechanical, electrical, plumbing (MEP) and fire protection systems with each other and with the building structure, enclosure, thermal envelope and interior design.
7. Ensure direct exterior access is provided (for CE) to main mechanical and electrical rooms.
8. Screen exterior equipment from primary views (landscape, building masses, screen walls) and comply with ATRP requirements.
9. Keep equipment away from main building entrances; locate service area/yard on least visible side of a building.

Plumbing

1. Use only Type Chlorinated polyvinyl chloride (CPVC) revision 1 for water piping inside facilities.
2. Dielectric unions shall be used where dissimilar metals are in contact.
3. MAFB does not allow the use of waterless urinals
4. Minimum Sanitary service connections from building shall be 4-inch minimum, with not less than a 2.5 FPS hydraulic velocity flow.
5. Verify that exterior sanitary service connections meet or exceed a 2.5 FPS hydraulic velocity flow when tied into existing sanitary site piping.
6. Provide a two-way ground clean out (GCO) on all sewer -soil or waste lines which enter the building. This GCO shall be identified as the POD between FGUA and Government maintenance requirements and responsibilities
7. Furnish minimum plumbing fixtures as indicated in the International Plumbing Code.
8. Provide branch isolation valves for branch piping serving multiple fixtures.

General

1. Coordinate the location of all exterior meters, equipment and devices to provide convenient access and an overall coordinated and orderly appearance.
2. Design emergency generator systems integrally with all other building systems and avoid incompatible building additions; locate generators near service areas and ensure they are not visible from primary entrances.

3. When structure is exposed as a finished ceiling, fully integrate MEP and fire protection systems to provide an organized uncluttered appearance.
4. Conceal ducts, piping, conduits, devices, etc., when permanent walls, suspended ceilings or raised floors are provided; locate sprinkler heads in orderly configuration.
5. Limit interior wall-mounted equipment in occupied personnel spaces; avoid surface-mounted conduit and pipes.
6. Provide efficient utility rooms with layouts to facilitate system performance and maintenance; provide convenient access to controls, clearly label systems and include operating and maintenance instructions.
7. Separate mechanical and electrical and communications rooms.
8. Integrate recessed and wall-mounted fixtures such as fire standpipe cabinets and drinking fountains within permanent walls.

E01. Building Configurations

Comply with Air Force Corporate Standards for Building Configurations:

<http://afcfs.wbdg.org/facilities-interiors/buildings-configurations/index.html>

1. Provide open-plan configurations for office, administrative, operational and related activities and spaces for maximum flexibility. Use a “core and shell” approach in which all building systems, infrastructure and permanent interior partitions anticipate two or more uses (operations) during a facility’s lifespan.
2. Create flexible interior configurations using Furniture, Fixtures & Equipment (FF&E) and limit private offices and private rooms. Refer to AFMAN 32-1084 for space requirements. To the greatest extent, limit permanent partitions to core areas such as toilet rooms, stairs, mechanical and utility rooms.
3. Use more durable long-lasting finishes in core areas for walls, ceilings, floor coverings and built-in casework. Coordinate interior FF&E layouts with structural grids during space planning.
4. Provide high-performance building configurations following UFC 1-200-02. Ensure passive design strategies are cost effectively incorporated before active mechanical systems are designed.
5. Comply with UFC 1-200-01, general building requirements. UFC 1-200-01 provides applicability of model building codes and government unique criteria for typical design disciplines and building systems, as well as for accessibility, antiterrorism, security, high performance and sustainability requirements, and safety.
6. Meet security and force protection requirements in UFC 4-010-01: DoD Minimum Antiterrorism Standards for Buildings.
7. Comply with AFCFS for supporting mission requirements, addressing human comfort and well being, and creating highly flexible interiors while satisfying metrics for high performance and sustainable buildings.
8. Provide a level of quality for interior features, materials and finishes that is appropriate for the Facility Group number. Group 1 may receive higher quality than Groups 2 thru 4. Refer to Facility Hierarchy.
9. Through open-plan configurations, preserve all passive and natural design strategies and fully integrate facility interiors with overall building systems.
10. Professional interior designers, or architects with significant interior design experience, must accomplish the design and review of applicable new construction, renovations and maintenance projects.
11. Consult with the State Historic Preservation Officer (SHPO) and base-level Historic Preservation offices regarding proposed changes to properties listed on or eligible for listing on the National Register of Historic Places. Follow requirements of The National Historic Preservation Act and Secretary of the Interior Standards for the Treatment of Historic Properties.
12. Maintain architectural compatibility following AFCFS and this Installation Facilities Standards (IFS) document to create continuity while avoiding monotony.

E01.1. Layout and Common Areas

Comply with Air Force Corporate Standards for Layout and Common Areas:

<http://afcfs.wbdg.org/facilities-interiors/buildings-configurations/layout-and-common-areas/index.html>

1. Create open-plan interior environments to accommodate changes.
2. Limit interior partitions, private offices and rooms; use furniture or modular systems to provide privacy and acoustic control.
3. When partitions are functionally justified such as for conference rooms, use systems furniture and moveable (demountable) floor-to-ceiling wall systems for acoustical or visual privacy.
4. Proportion lobbies and common spaces based on type of function, activity and facility group.

5. Allow no direct sight lines into restrooms.
6. Situate utility and core areas to minimize impact on daylighting and to maximize use as thermal buffers.
7. Ensure electrical, lighting and communications system can be adaptable to configuration changes.
8. Avoid power poles to the maximum extent; when poles are necessary minimize the number and coordinate locations with furniture placement and other elements.
9. Avoid sloping floors to maintain flexibility and eliminate future structural changes.
10. Special consideration may apply to Sensitive Compartmented Information Facilities (SCIFs).

E01.1.1. Interior Design Process

1. Comply with UFC 3-120-10 for the Comprehensive Interior Design (CID,) which includes both Structural Interior Design (SID) and Furniture, Fixtures & Equipment (FF&E) design services.
2. Use a collaborative, integrated planning and design team, composed of user, government support staff, and appropriate professionals. Integrate architectural features using simple detailing to create a professional appearance; avoid extravagant or excessive detailing.
3. Ensure interior designs satisfy the functional requirements within the context of flexibility, sustainability and the building's energy performance.
4. Base space planning on square foot allocations from AFM 32-1084. Identify special requirements if any, such as privacy separation, VIP areas, gathering spaces and storage. Note: The occupant's rank and position will influence the square footage and selection of materials.
5. Provide clear circulation and pathway finding for both horizontal and vertical directions that accommodate the number of personnel in the facility.
6. Maximize efficiencies in the space plan for functional relationships and adjacencies for all facility users. Efficiently create and situate rooms and support rooms such as conference / meeting rooms and break rooms.
7. Provide interior design building-related illustrations, drawings, schedules, materials selections, specifications and cost estimates as listed in UFC 3-120-10. Refer to Furnishings in this IFS also.
8. SID Format shall follow HQ AFCEC standards.
9. Base the FF&E package on the furniture footprint developed in the SID. Identify all new or existing equipment needed and its users within each facility or each area of the facility. Provide specific information on: equipment sizes, electrical requirements, ventilation requirements, weight (if heavy), quantity, and security level if required. Presume all administrative spaces have computers and supporting equipment.

E01.1.2. Codes and Regulations

1. Refer to UFC 1-200-01 for modifications to the International Building Code (IBC) to determine applicable sections of the IBC. Both the IBC Chapter 3 and UFC 3-600-01 govern "Use and Occupancy Classification" for example.
2. Fire code requirements shall be as defined in the International Building Code (IBC) and must be used where dictated by UFC 1-200-01 DoD Building Code (General Building Requirements) except where noted in UFC 3-600-01 (Fire Protection Engineering For Facilities).
3. National Fire Protection Association (NFPA) 101 must be utilized to determine the occupancy classification as it relates to fire/smoke resistance rating of interior non-load bearing partitions (other than occupancy separation), means of egress, interior finish, features of fire protection (including vertical openings) and associated requirements.

E01.2. Quality and Comfort

Comply with Air Force Corporate Standards for Quality and Comfort:

<http://afcs.wbdg.org/facilities-interiors/buildings-configurations/quality-and-comfort/index.html>

1. Include durability in the life cycle cost analysis for best-value material selections with long life expectancies that do not show excessive wearing.
2. Select long-lasting materials and finishes for permanent core areas such as lobbies, restrooms and stairs.
3. Select low-maintenance materials and products that reduce ongoing servicing and repair and that are easy to clean.
4. Relate the visual quality of finishes to the Facility Group number.
5. Building and interior configurations should address both operations and climatic responses.
6. Convey a professional image; avoid trendy patterns and textures.
7. Use materials and finishes that provide a healthy indoor environment.
8. Orient interior spaces toward views while maintaining cost-effective building performance and efficiency.
9. Promote air movement and daylighting for human health and wellbeing.

E02. Floors

Comply with Air Force Corporate Standards for Floors:

<http://afcs.wbdg.org/facilities-interiors/floors/index.html>

E02.1. Floor Materials

Facility Group 1 floor materials shall be as follows.

Primary: Prepared Slabs (Ground, Polished)

Secondary: Porcelain tile

Tertiary: Carpet, Rubber Stair Treads

Facility Group 2 floor materials shall be as follows.

Primary: Prepared Slabs (Ground, Polished)

Secondary: Ceramic tile

Tertiary: Carpet, Rubber Stair Treads

Facility Group 3 floor materials shall be as follows.

Primary: Prepared Slabs (Ground)

Secondary: Prepared Slabs (Sealer)

Tertiary: N/A

Facility Group 4 floor materials shall be as follows.

Primary: Carpet

Secondary: Ceramic tile

Tertiary: N/A

1. Natural stone and terrazzo flooring may be used in high traffic areas of Group 1 as approved on a case basis.
2. Resilient and rapidly renewable flooring may be used in low traffic areas in Group 1, 2 and 4.
3. Manufacturers listed below are only provided to establish a baseline of equivalency among all applicable manufacturers.

Note: Apply the below base-wide standards for Floors (products, materials and color). Then refer to the Appendix and apply any additional requirements specifically related to the Facility District in which the project is located.

E02.1.1. Prepared Slabs

Applicable N/A

Number of base standards 1

Image Tool 250 x 188



Type: **Ground and Polished Slabs**

Applies to: Group 1 Group 2 Group 3 Group 4 Other

Mfr: Local TBD

Color: Natural gray cement, light to dark beige aggregates

Finish: Fine to medium polished texture, slip resistant

Model #: Medium to small aggregate

Other: N/A

UFGS: Section 03 35 45 Polished Concrete Finishing
(Not Available on UFGS)

E02.1.2. Natural Stone and Terrazzo

Applicable N/A

E02.1.3. Quarry Tile

Applicable N/A

E02.1.4. Ceramic Tile

Applicable N/A

Number of base standards 1

Image Tool 250 x 188



Type: **Porcelain Tile**

Applies to: Group 1 Group 2 Group 3 Group 4 Other

Mfr: Daltile

Color: Earth tones

Finish: Matte, slip resistant

Model #: Porcelain tile

Other: Use in high traffic areas. Epoxy grout is recommended.

UFGS: Section 09 30 10 Ceramic, Quarry, and Glass Tiling
<http://www.wbdg.org/FFC/DOD/UFGS/UFGS 09 30 10.pdf>

E02.1.5. Resilient Floor

Applicable N/A

Number of base standards 1

Image Tool 250 x 188



Type: **Rubber Stair Treads**

Applies to: Group 1 Group 2 Group 3 Group 4 Other

Mfr: Roppe

Color: Neutral tones

Finish: Factory

Model #: Raised design rubber tread

Other: Stair treads material

UFGS: Section 09 65 00 Resilient Flooring
<http://www.wbdg.org/FFC/DOD/UFGS/UFGS 09 65 00.pdf>

E02.1.6. Carpet

Applicable N/A

Number of base standards 2

Image Tool 250 x 188



Type: **Commercial**

Applies to: Group 1 Group 2 Group 3 Group 4 Other

Mfr: Mohawk Group

Color: Neutral multi-colored tones/patterned/solid

Finish: Yarn: Nylon 6 or 6.6/cut pile or loop pile

Model #: Broadloom, 6' wide rolled, carpet tiles, entry walk-off carpet

Other: N/A

UFGS: UFGS 09 68 00 Carpeting

<http://www.wbdg.org/FFC/DOD/UFGS/UFGS 09 68 00.pdf>

Type: **Residential**

Applies to: Group 1 Group 2 Group 3 Group 4 Other

Mfr: Mohawk Group

Color: Earth tones

Finish: Factory

Model #: Broadloom, residential loop, "Smartstrand"

Other: N/A

UFGS: UFGS 09 68 00 Carpeting

<http://www.wbdg.org/FFC/DOD/UFGS/UFGS 09 68 00.pdf>

E02.1.7. Rapidly-Renewable Products

Applicable N/A

E02.1.8. Other

Applicable N/A

E03. Walls

Comply with Air Force Corporate Standards for Walls:
<http://afcs.wbdg.org/facilities-interiors/walls/index.html>

E03.1. Wall Materials

Facility Group 1 wall materials shall be as follows.

Primary: Concrete or brick
Secondary: Gypsum board (painted)
Tertiary: Ceramic tile (restrooms)

Facility Group 2 wall materials shall be as follows.

Primary: Concrete or brick
Secondary: Gypsum board (painted)
Tertiary: Ceramic tile (restrooms)

Facility Group 3 wall materials shall be as follows.

Primary: Concrete or brick
Secondary: Gypsum board (painted)
Tertiary: Ceramic tile (restrooms)

Facility Group 4 wall materials shall be as follows.

Primary: Gypsum board (painted)
Secondary: N/A
Tertiary: Ceramic tile (restrooms)

1. Follow UFC 3-450-01 (Vibration and Noise Control) for acoustic design issues including speech privacy, sound isolation or sound masking.
2. Select and apply paint with sheens (gloss levels) appropriate for the application following UFGS Section 09 90 00 Paints and Coatings.
3. Provide ceramic tile on wet walls of kitchens, toilet rooms, locker rooms, etc., in all facility groups.
4. Neutral split-face or ground-face integrally colored block with a clear sealer may be used in Group 3. Do not paint block.
5. Provide rubber base on drywall partitions in Groups 1 and 2.
6. Hardwood base may only be used in Group 1 as approved on a case basis.
7. Hardwood chair rails / bumper rails may be used in high-use areas of Groups 1 and 2; aqueous clear finishes are preferred to reduce maintenance; plastic chair rails are permitted only in medical applications.
8. Decorative moldings may be used only in Group 1 when approved on a case basis.
9. Corner guards are permitted only in high traffic spaces with wheeled or cart use such as private service areas in Groups 1 and 2; stainless steel corners guards with a brushed finish may be judiciously used in Group 3.
10. Group 4 may use painted composite wood base.
11. Manufacturers listed below are only provided to establish a baseline of equivalency among all applicable manufacturers.

Note: Apply the below base-wide standards for Walls (products, materials and color). Then refer to the Appendix and apply any additional requirements specifically related to the Facility District in which the project is located.

E03.1.1. Concrete

Applicable N/A

Number of base standards 1

Image Tool 250 x 188



Type: **CMU Back-up with Cement Plaster Finish**

Applies to: Group 1 Group 2 Group 3 Group 4 Other

Mfr: Local TBD

Color: Medium beige

Finish: Sand

Model #: 2-coat cementitious system

Other: Interior plaster may be painted

UFGS: Section 04 20 00 Unit Masonry

<http://www.wbdg.org/FFC/DOD/UFGS/UFGS 04 20 00.pdf>

E03.1.2. Masonry

Applicable N/A

E03.1.3. Ceramic Tile

Applicable N/A

Number of base standards 1

Image Tool 250 x 188

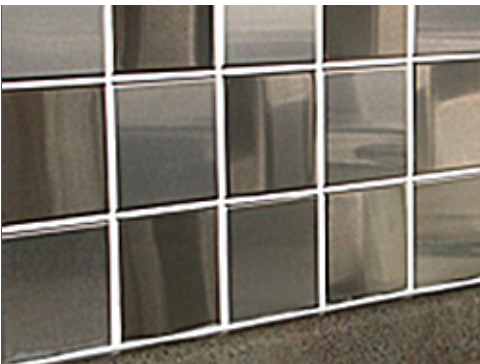

Type: **Style 1**

Applies to: Group 1 Group 2 Group 3 Group 4 Other

Mfr: Daltile

Color: Earth tones

Finish: Gloss, semi-gloss

Model #: Ceramic wall tile

Other: Located on wet walls in restrooms

UFGS: Section 09 30 10 Ceramic, Quarry, and Glass Tiling

<http://www.wbdg.org/FFC/DOD/UFGS/UFGS 09 30 10.pdf>

E03.1.4. Gypsum Board

Applicable N/A

Number of base standards 1

Image Tool 250 x 188



Type: **Style 1**

Applies to: Group 1 Group 2 Group 3 Group 4 Other

Mfr: US Gypsum

Color: Solid Earth tone colors

Finish: Paint (Sheen per UFGS)

Model #: Tapered edge

Other: N/A

UFGS: Section 09 29 00 Gypsum Board

<http://www.wbdg.org/FFC/DOD/UFGS/UFGS 09 29 00.pdf>

Section 09 90 00 Paints and Coatings

<http://www.wbdg.org/FFC/DOD/UFGS/UFGS 09 90 00.pdf>

E03.1.5. Metal Panels

Applicable N/A

E03.1.6. Wood Paneling

Applicable N/A

E03.1.7. Rapidly-Renewable Products

Applicable N/A

E03.1.8. Other

Applicable N/A

E04. Ceilings

Comply with Air Force Corporate Standards for Ceilings:

<http://afcfs.wbdg.org/facilities-interiors/ceilings/index.html>

E04.1. Ceiling Materials

Facility Group 1 ceiling materials shall be as follows.

- Primary: Exposed Framing (Roof / Floor Structure Above)
- Secondary: Grid and Acoustical Tile
- Tertiary: Gypsum board (painted)

Facility Group 3 ceiling materials shall be as follows.

- Primary: Exposed Framing (Roof / Floor Structure Above)
- Secondary: Grid and Acoustical Tile
- Tertiary: Gypsum board (painted)

Facility Group 2 ceiling materials shall be as follows.

- Primary: Exposed Framing (Roof / Floor Structure Above)
- Secondary: Grid and Acoustical Tile
- Tertiary: Gypsum board (painted)

Facility Group 4 ceiling materials shall be as follows.

- Primary: Gypsum board (painted)
- Secondary: N/A
- Tertiary: N/A

1. Accent ceiling materials such as metal, wood, and rapidly renewable may be used in Group 1 as approved on a case basis.
2. Follow UFC 3-450-01 (Vibration and Noise Control) for acoustic design issues including speech privacy, sound isolation or sound masking.
3. Manufacturers listed below are only provided to establish a baseline of equivalency among all applicable manufacturers.

Note: Apply the below *base-wide standards* for Ceilings (products, materials and color). Then refer to the Appendix and apply any additional requirements specifically related to the Facility District in which the project is located.

E04.1.1. Exposed Framing (Roof / Floor Structure Above)

Applicable N/A Number of base standards 1

Image Tool 250 x 188



Type: **Exposed Structure**

Applies to: Group 1 Group 2 Group 3 Group 4 Other

Mfr: Vulcraft

Color: Neutral colors reviewed on a case basis

Finish: Field painted (Sheen per UFGS)

Model #: Formlok floor and roof decking, steel structure

Other: N/A

UFGS: Section 05 30 00 Steel Decks
http://www.wbdg.org/FFC/DOD/UFGS/UFGS_05_30_00.pdf

E04.1.2. Exposed Concrete

Applicable N/A

E04.1.3. Grid and Acoustical Tile

Applicable N/A Number of base standards 1

Image Tool 250 x 188



Type: **Style 1**

Applies to: Group 1 Group 2 Group 3 Group 4 Other

Mfr: Armstrong

Color: Dune or Cirris

Finish: Factory

Model #: 2'x2' Tegular with reveal edge

Other: Humiguard Plus, Sag-resistant White as approved by the BCE. Prelude grid 15/16" or Suprafine grid 9/16" white.

UFGS: Section 09 51 00 Acoustical Ceilings
<http://www.wbdg.org/FFC/DOD/UFGS/UFGS 09 51 00.pdf>

E04.1.4. Gypsum Board

Applicable N/A Number of base standards 1

Image Tool 250 x 188



Type: **Style 1**

Applies to: Group 1 Group 2 Group 3 Group 4 Other

Mfr: US Gypsum

Color: Solid neutral colors

Finish: Paint (sheen per UFGS)

Model #: Tapered edge

Other: N/A

UFGS: Section 09 29 00 Gypsum Board
<http://www.wbdg.org/FFC/DOD/UFGS/UFGS 09 29 00.pdf>
Section 09 90 00 Paints and Coatings
<http://www.wbdg.org/FFC/DOD/UFGS/UFGS 09 90 00.pdf>

E04.1.5. Metal Panels

Applicable N/A

E04.1.6. Wood

Applicable N/A

E04.1.7. Rapidly-Renewable Products

Applicable N/A

E04.1.8. Other

Applicable N/A

E05. Doors and Windows

Comply with Air Force Corporate Standards for Doors and Windows:

<http://afcs.wbdg.org/facilities-interiors/doors-and-windows/index.html>

E05.1. Doors and Windows and Frames Materials

Facility Group 1

door (frame) and window frame materials shall be as follows.

Primary: Aluminum, dark bronze

Secondary: Hollow metal (painted)

Tertiary: N/A

Facility Group 1

door (leaf) materials shall be as follows.

Primary: Aluminum, dark bronze and Insulated Glass

Secondary: Insulated, Hollow metal (painted)

Tertiary: N/A

Facility Group 2

door (frame) and window frame materials shall be as follows.

Primary: Aluminum, dark bronze

Secondary: Hollow metal (painted)

Tertiary: N/A

Facility Group 2

door (leaf) materials shall be as follows.

Primary: Aluminum, dark bronze and Insulated Glass

Secondary: Insulated, Hollow metal (painted)

Tertiary: N/A

Facility Group 3

door (frame) and window frame materials shall be as follows.

Primary: Hollow metal (galvanized, painted)

Secondary: Hollow metal (galvanized)

Tertiary: N/A

Facility Group 3

door (leaf) materials shall be as follows.

Primary: Hollow metal (galvanized, painted)

Secondary: Hollow metal (galvanized)

Tertiary: N/A

Facility Group 4

door (frame) and window frame materials shall be as follows.

Primary: Wood

Secondary: N/A

Tertiary: N/A

Facility Group 4

door (leaf) materials shall be as follows.

Primary: Wood solid core

Secondary: Composite solid core

Tertiary: N/A

1. Typically, interior wood door slabs shall be 1 & ¾-inch thick, solid core, particleboard core, 1LD2, 32 lbs/cu ft, hardwood rails & stiles, birch veneer, white birch, (all sapwood), custom grade, stain grade, and book matched.
2. The BOD for interior steel doors shall be as manufactured by Steelcraft. Slabs to be 16 gauge, cold rolled G60 galvanized steel, seamless with appropriate foamed insulated core to enhance sound control. Doors shall be factory primed / American Nation Standards Institute (ANSI) a224.1.
3. The BOD for steel frames shall be as manufactured by Steelcraft, 16 gauge, G60 galvanized steel, and primed for jobsite finishing. Reinforce at all hardware locations with galvanized steel: 7 gauge at hinges; 14 gauge at strike. Kerfed frames for gasketed sound and air infiltration control.
4. Do not use hollow-core wood doors.
5. Generally match original hardware in renovations.
6. Manufacturers listed below are only provided to establish a baseline of equivalency among all applicable manufacturers.

Hardware

1. Hinges must be heavy duty, 5 knuckle, stainless steel base metal and finish with NRP. Best hardware: 45H Series (full mortise); interchangeable cores; stainless steel base metal lever style 14; escutcheon J; compatible strike; 630 satin stainless steel.
2. Select finishes that will not degrade by intensity of operation or exposure to the elements.
3. Use consistent finishes and color on window and door systems throughout a facility. For renovation projects the color of new hardware may match the existing hardware.
4. Design building systems to eliminate the need for security screens whenever possible.

Note: Apply the below base-wide standards for Doors and Windows (products, materials and color). Then refer to the Appendix and apply any additional requirements specifically related to the Facility District in which the project is located.

E05.1.1. Aluminum

Applicable N/A

Number of base standards 1

Image Tool 250 x 188

Type: **Style 1**

Applies to: Group 1 Group 2 Group 3 Group 4 Other

Mfr: Kawneer

Color: Black or clear anodized as approved by the BCE

Finish: Factory

Model #: Interior Framing

Other: Aluminum door with glass lite, satin stainless steel hardware



UFGS: Section 08 41 13 Aluminum-Framed Entrances and Storefronts
<http://www.wbdg.org/FFC/DOD/UFGS/UFGS 08 41 13.pdf>
 Section 08 71 00 Door Hardware
<https://www.wbdg.org/FFC/DOD/UFGS/UFGS 08 71 00.pdf>

E05.1.2. Hollow Metal

Applicable N/A

Number of base standards 1

Image Tool 250 x 188



Type: **Steel Doors**

Applies to: Group 1 Group 2 Group 3 Group 4 Other

Mfr: Steelcraft

Color: Neutral colors

Finish: Paint (Sheen per UFGS)

Model #: Hollow metal, 2" w. frames, 16 gauge (welded corners) grouted solid

Other: Provide in Group 3 and in utility areas of Group 1 and 2. Provide A25 "galvannealed" coating. All interior steel doors shall have a factory applied primer finish. Provide satin stainless steel hardware.

UFGS: Section 08 11 13 Steel Doors and Frames
<http://www.wbdg.org/FFC/DOD/UFGS/UFGS 08 11 13.pdf>
Section 08 71 00 Door Hardware
<https://www.wbdg.org/FFC/DOD/UFGS/UFGS 08 71 00.pdf>

E05.1.3. Wood

Applicable N/A

Number of base standards 2

Image Tool 250 x 188



Type: **Style 1, Administrative Wood Doors**

Applies to: Group 1 Group 2 Group 3 Group 4 Other

Mfr: Simpson

Color: Natural Maple hardwood veneer solid core

Finish: Clear sealer, satin (aqueous)

Model #: 3'x7'x 1 3/4", solid core

Other: Satin stainless steel hardware, Glass lites may be used. Stained birch veneer face, 5 ply construction, rotary cut finish.

UFGS: Section 08 14 00 Wood Doors
<http://www.wbdg.org/FFC/DOD/UFGS/UFGS 08 14 00.pdf>
Section 08 71 00 Door Hardware
<https://www.wbdg.org/FFC/DOD/UFGS/UFGS 08 71 00.pdf>

Type: **Style 2, Residential Wood Doors**

Applies to: Group 1 Group 2 Group 3 Group 4 Other

Mfr: Simpson

Color: Natural hardwood veneer, clear sealer or paint-grade, white

Finish: Satin (aqueous)

Model #: Full slab or panels

Other: Fiberglass doors may be used in VQ or TLF areas with BCE approval, painted white. Provide satin nickel hardware.

UFGS: Section 08 14 00 Wood Doors

<http://www.wbdg.org/FFC/DOD/UFGS/UFGS 08 14 00.pdf>

Section 08 71 00 Door Hardware

<https://www.wbdg.org/FFC/DOD/UFGS/UFGS 08 71 00.pdf>

E05.1.4. Other

Applicable N/A

E06. Casework Systems

Comply with Air Force Corporate Standards for Casework Systems:

<http://afcs.wbdg.org/facilities-interiors/casework-systems/index.html>

E06.1. Casework Materials

1. Select casework systems and materials considering durability, maintenance requirements and LCCA.
2. Natural stone and cast stone countertops may only be used in Group 1 with approval on a case basis. Solid-surface shall be used in Groups 1, 2, and 3, unless otherwise noted.
3. Metal cabinets and countertops shall be provided in heavy-use operations and in Group 3.
4. Refer to AFCFS for approved materials.
5. Manufacturers listed below are only provided to establish a baseline of equivalency among all applicable manufacturers.

E06.1.1. Plastic Laminate

Applicable N/A

Number of base standards 1

Image Tool 250 x 188



Type: **Style 1, Low Use Areas Only**

Applies to: Group 1 Group 2 Group 3 Group 4 Other

Mfr: Formica

Color: Medium Earth tones and neutral tones

Finish: Light textured

Model #: High pressure laminate

Other: Combine with matching solid-surface banding on casework edges.
Only for use as approved by the BCE in an Facility Group.

UFGS: Section 06 41 16.00 10 Plastic-Laminate-Clad Architectural Cabinets
<http://www.wbdg.org/FFC/DOD/UFGS/UFGS 06 41 16.00 10.pdf>

E06.1.2. Solid Polymer Surface

Applicable N/A

Number of base standards 1

Image Tool 250 x 188



Type: **Style 1, High Use Areas**

Applies to: Group 1 Group 2 Group 3 Group 4 Other

Mfr: Corian (or equivalent)

Color: Off white or as approved by BCE

Finish: Smooth

Model #: Solid surface

Other: Faces and edge banding

UFGS: Section 12 36 00 Countertops
<http://www.wbdg.org/FFC/DOD/UFGS/UFGS 12 36 00.pdf>

E06.1.3. Rapidly-Renewable Products

Applicable N/A

Number of base standards 1

Image Tool 250 x 188



Type: **Style 1 Moderate Use Areas**

Applies to: Group 1 Group 2 Group 3 Group 4 Other

Mfr: Plyboo

Color: Natural or amber

Finish: Satin

Model #: Flat grain bamboo plywood

Other: FSC® Certified 100%.

UFGS: Section 12 32 00 Manufactured Wood Casework
<http://www.wbdg.org/FFC/DOD/UFGS/UFGS 12 32 00.pdf>

E06.1.4. Metal

Applicable N/A

E06.2. Countertop Materials

E06.2.1. Plastic Laminate

Applicable N/A

E06.2.2. Solid Polymer Surface

Applicable N/A

Number of base standards 1

Image Tool 250 x 188



Type: **Style 1, High Use Areas**

Applies to: Group 1 Group 2 Group 3 Group 4 Other

Mfr: Corian

Color: Medium Earth tones and neutral tones

Finish: Light textured

Model #: Solid surface

Other: Finished edges

UFGS: Section 12 36 00 Countertops

[http://www.wbdg.org/FFC/DOD/UFGS/UFGS 12 36 00.pdf](http://www.wbdg.org/FFC/DOD/UFGS/UFGS_12_36_00.pdf)

E06.2.3. Natural Stone

Applicable N/A

Number of base standards 1

Image Tool 250 x 188



Type: **Style 1, Group 1 High Visibility, Heavy Use**

Applies to: Group 1 Group 2 Group 3 Group 4 Other

Mfr: Local TBD

Color: Neutral tones

Finish: High polish, sealer

Model #: Custom cut slabs

Other: N/A

UFGS: Section 12 36 00 Countertops

[http://www.wbdg.org/FFC/DOD/UFGS/UFGS 12 36 00.pdf](http://www.wbdg.org/FFC/DOD/UFGS/UFGS_12_36_00.pdf)

E06.2.4. Cast Stone

Applicable N/A

Number of base standards 1

Image Tool 250 x 188

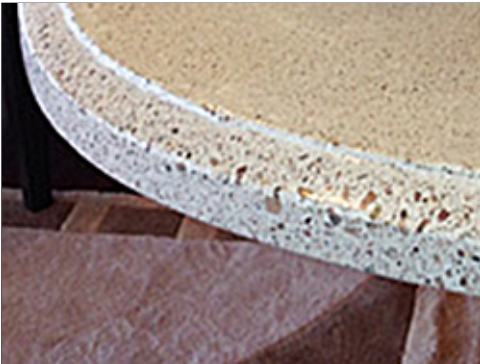

Type: **Style 1, Group 1 and 2 High Visibility, Heavy Use**

Applies to: Group 1 Group 2 Group 3 Group 4 Other

Mfr: Local TBD

Color: Neutral tones

Finish: High polish, sealer

Model #: Custom cast or cut slabs

Other: N/A

UFGS: Section 12 36 00 Countertops

<http://www.wbdg.org/FFC/DOD/UFGS/UFGS 12 36 00.pdf>

E06.2.5. Metal

Applicable N/A

Number of base standards 1

Image Tool 250 x 188

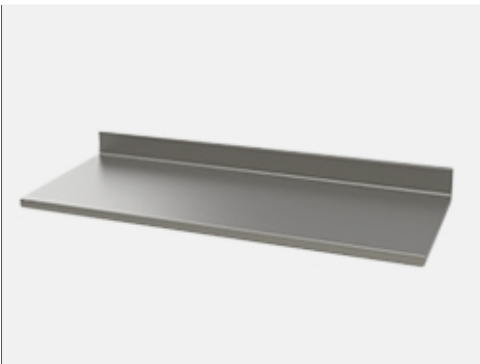

Type: **Stainless Steel Countertops**

Applies to: Group 1 Group 2 Group 3 Group 4 Other

Mfr: Local TBD

Color: Natural stainless steel

Finish: Mill

Model #: Custom fabricated countertops

Other: Provide integral fronts, sides and backsplash

UFGS: Section 12 31 00 Manufactured Metal Casework

<http://www.wbdg.org/FFC/DOD/UFGS/UFGS 12 31 00.pdf>

E07. Furnishings

Comply with Air Force Corporate Standards for Furnishings:

<http://afcs.wbdg.org/facilities-interiors/furnishings/index.html>

E07.1. Durability and Serviceability

Comply with AF Corporate Standards for Durability and Serviceability:

<http://afcs.wbdg.org/facilities-interiors/furnishings/durability-and-serviceability/index.html>

E07.2. Accessories

Comply with AF Corporate Standards for Accessories:

<http://afcs.wbdg.org/facilities-interiors/furnishings/accessories/index.html>

E08. Interior Signs

Comply with Air Force Corporate Standards for Interior Signs:

<http://afcs.wbdg.org/facilities-interiors/interior-signs/index.html>

E08.1 Types and Color

Comply with Air Force Corporate Standards for Types and Color:

<http://afcs.wbdg.org/facilities-interiors/interior-signs/types-and-color/index.html>

E08.2. Interior Signs Materials

1. Interior signage must meet UFC requirements and receive approval by the BCE.

E09. Lighting, Power and Communication

<http://afcs.wbdg.org/facilities-interiors/lighting-power-and-communication/index.html>

E09.1. Functionality and Efficiency

Comply with Air Force Corporate Standards for Functionality and Efficiency:

<http://afcs.wbdg.org/facilities-interiors/lighting-power-and-communication/functionality-and-efficiency/index.html>

E09.2. Types and Color

1. Interior administrative lighting shall be Lithonia Breez Series Recessed LED Model 2B2L4, Architectural Recessed LED Lighting 2x2 or 2x4 or similar as approved by the BCE.

F. APPENDIX - Facility Districts

- Applicable
- N/A

Comply with Air Force Corporate Standards for Facility Districts:
<http://afcs.wbdg.org/facility-districts/index.html>

Facilities Districts Overview Map:

Image Tool 800 x 600

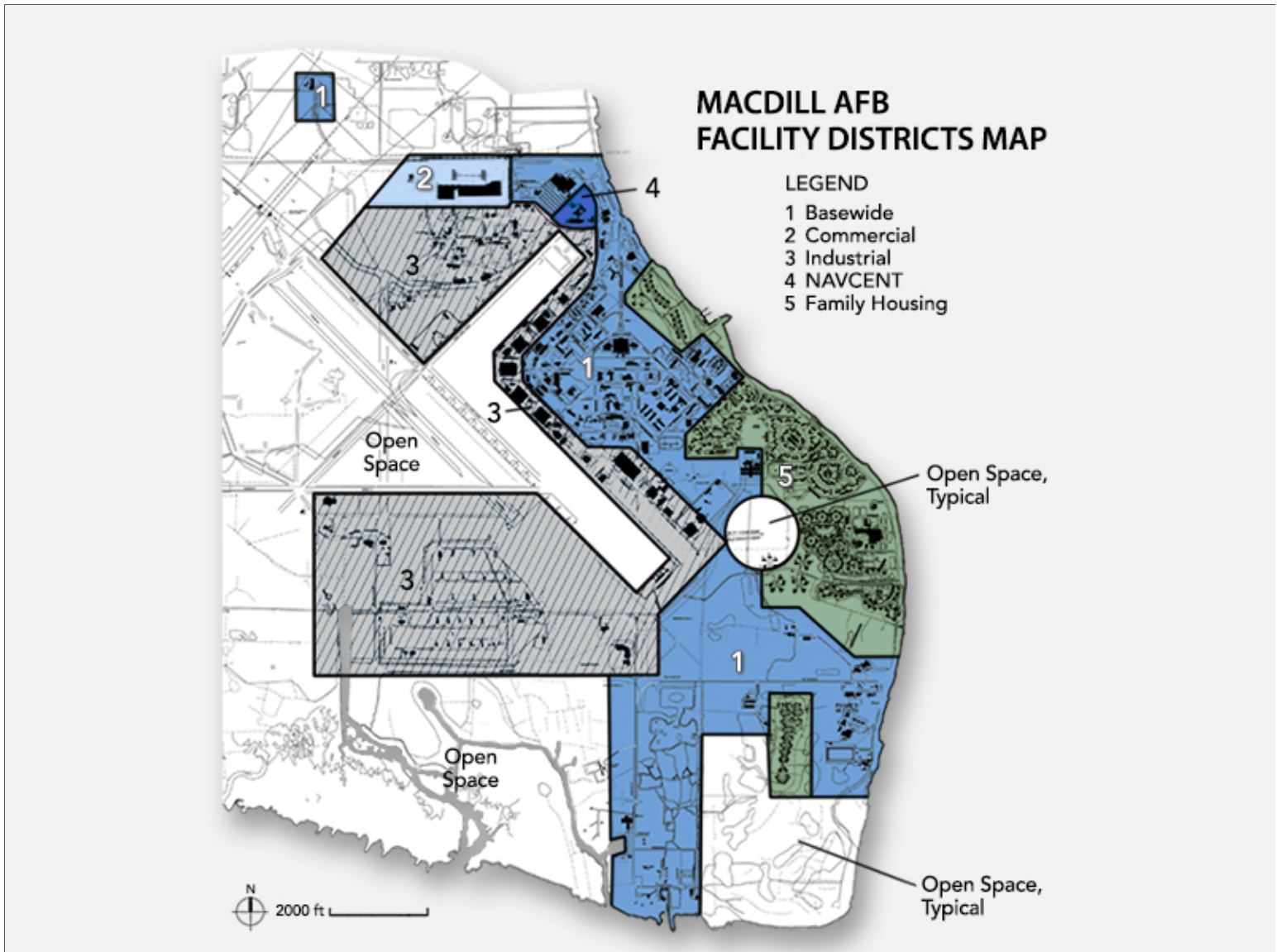

Note: Apply the base-wide standards in this IFS for Installation Elements, Site Development, Facilities Exteriors and Facilities Interiors (products, materials, color, etc.). Following application of the base-wide standards, refer to the Appendix and apply any additional requirements specifically related to the Facility District.

Enter No. of Facility Districts 1

The following Facility Districts list exceptions to the base standards that are unique to each district. Please refer to the Site Development, Facilities Exteriors, and Facilities Interiors sections of this IFS for base standards.

Name of District: Basewide Standards Map

Image Tool 800 x 600

Map of District

Facility Numbers	
1	Hangar
2	Hangar
3	Hangar
4	Hangar
5	Hangar
11	Warehouse
12	BCE Shops
26	Fire Station
27	Community Facility
28	Product PTL/Storage
29	Maintenance Shop
30	Engineering Administration
31	Maintenance Shop
32	Maintenance Shop
33	Maintenance Shop
34	Storage Shed
35	Maintenance Shop
37	Water Tower
41	Theater
42	Instrument PME Laboratory
45	Storage Facility
47	Swimming Pool/Clubhouse
68	Storage Facility
111	Storage Facility
117	Garage
172	Warehouse
227	Warehouse
249	Training Facility
297	Warehouse
311	Library
347	Engineering Administration
397	Officers' Club
398	GOO Garages
401	Family Housing GOO
402	Family Housing GOO
403	Family Housing GOO
404	Family Housing GOO
405	Family Housing GOO
501	NCO Housing
502	NCO Housing
503	NCO Housing
507	Vehicle Shop
552	Warehouse
731	Storage Facility
927	Pump Station
928	Pump Station
1050	Maintenance Shop



Photos for each facility group within the Facility District as applicable.

Image Tool 250 x 188

Group 1 Applicable N/A

Group 2 Applicable N/A

Group 3 Applicable N/A

Group 4 Applicable N/A

Other Applicable N/A

FACILITY DISTRICTS

MacDill Air Force Base is divided into districts that align with land use zones as defined by the installation's General Plan. Each district has designated uses that help to define facility operations. Generally match adjacent facilities in new construction to promote architectural compatibility throughout the installation. Please refer to Section D03.2. and contact the Base Civil Engineer for additional information. A brief description of each of the districts follows.

1. Basewide (Community Setting)
2. Commercial Area
3. Industrial Area
4. NAVCENT Compound
5. Family Housing
Open Space

1. Basewide (Community Setting)

Facilities in the Basewide (Community Setting) District should continue to be pedestrian in scale. Implement the installation's prevailing architectural style, central Florida regionalism, during major renovations or new construction as appropriate.

2. Commercial

The Commercial District should be pedestrian in scale. Application of the installation prevailing architectural style, central Florida regionalism, should be implemented during major renovations or new construction as appropriate.

3. Industrial

The Industrial District includes facilities that are industrial in nature. These facilities may support flightline operations. Other facilities include (warehouses for various base activities including maintenance, storage, utility functions, industrial services, transportation storage, communications, civil engineering, supply and equipment, fuel storage, vehicle maintenance/motor pool complex, open storage, emergency/disaster response facilities, ordnance and weapons storage areas,) and other industrial uses. Facilities in this district are industrial in nature, should generally match adjacent buildings to ensure architectural compatibility and shall follow standards for Facility Group 3 as defined in this IFS.

4. NAVCENT Compound

The NAVCENT Compound District should maintain a pedestrian scale at the street level. Application of the installation prevailing architectural style, central Florida regionalism, should be implemented during major renovations or new construction as appropriate.

5. Family Housing

The Family Housing District consists of detached single family residential units occupied by enlisted and officer families. This area is currently under a housing privatization contract, but shall follow standards for Facility Group 4 as defined in this IFS.

6. Open Space

Open space includes undeveloped land both inside and outside of the immediate cantonment area. It both separates and defines the various sections of the base and creates a natural setting for the cantonment area. Areas classified as open space may be undeveloped to act as a buffer space between incompatible uses or for safety or security clearances or there may be other constraints that are not readily visible. All development in this district requires prior coordination and approval from the Base Civil Engineer.

G. APPENDIX - References

Comply with Air Force Corporate Standards:
<http://afcs.wbdg.org/index.html>