(PRE-FINAL) KEESLER AIR FORCE BASE INSTALLATION FACILITIES STANDARDS (IFS)



Installation Elements



Site Development



Facilities Exteriors



Facilities Interiors

APPROVED FOR PUBLIC RELEASE; DISTRIBUTION UNLIMITED

Signature Field

Keesler Air Force Base IFS

Table of Contents

A. OVERVIEW	5	B03.2.3. Preserves	
A01. Facility Hierarchy	5	B03.2.4. Perimeter Fence	
A02. Facility Quality	5	C. SITE DEVELOPMENT	32
A03. Facility Districts	5	C01. Site Design	32
B. INSTALLATION ELEMENTS	7	C01.1. Site Design Considerations	32
B01. Comprehensive Planning	7	C01.2. Building Orientation	33
B01.1. Installation Development Plan (IDP)	7	C02. Utilities	34
B01.1.1. IFS Component Plan of IDP		C02.1. Utility Components	34
B01.1.2. Brief History of Base		C03. Parking Areas	35
B01.1.3. Future Development		C03.1. Configurations and Design	35
B02. Street Envelope Standards	12	C03.1.1. Paving and Striping	
B02.1. Hierarchy of Streets	13	C03.1.2. Curbing	
B02.1.1. Arterial Streets		C03.1.3. Internal Islands and Medians	
B02.1.2. Collector Streets		C03.2. Parking Structures	38
B02.1.3. Local Streets		C03.3. Connectivity	38
B02.1.4. Special Routes		C04. Stormwater Management	39
B02.2. Hierarchy of Intersections	18	C04.1. Stormwater Requirements	39
B02.2.1. Arterials		C05. Sidewalks, Bikeways and Trails	39
B02.2.2. Arterial/Collector		C05.1. Circulation and Paving	40
B02.2.3. Collectors		C05.1.1. Ramps and Stairs	
B02.2.4. Special Intersections		C05.1.2. Lighting	
B02.2.5. Street Frontage Requirements		C06. Landscape	42
B02.2.6. Sight Lines		C06.1. Climate-based Materials	43
B02.3. Street Elements	21	C06.1.1. Landscape Design Concept	
B02.3.1. Paving		C06.1.2. Xeriscape Design Principles	
B02.3.2. Curb and Gutter		C06.1.3. Minimizing Water Requirements	
B02.3.3. Utility Service Elements		C06.1.4. Plant Material Selection	
B02.3.4. Traffic Signs		C06.1.5. Water Budgeting (Hydrozones)	
B02.3.5. Street Lighting		C06.1.6. Base Entrance Landscaping	
B02.3.6. Other		C06.1.7. Streetscape Landscaping	
B03. Open Space / Public Space	23	C06.1.8. Pedestrian Circulation Landscaping	
B03.1. Plazas, Monuments and Static Displays	24	C06.1.9. Parking Lot Landscaping	
B03.1.1. Paved Plazas		C06.1.10. Screen/Accent Landscaping	
B03.1.2. Sculptures, Markers and Statuary		C06.1.11. Other	
B03.1.3. Static Display of Aircraft		C07. Site Furnishings	50
B03.2. Grounds and Perimeters	26	C07.1. Furnishings and Elements	50
B03.2.1. Parade Grounds			
B03.2.2. Parks			

Table of contents continued

C07.2. Site Furnishings Products, Materials / Color ..	52	D03.3.4. Thermal Shading	
C07.2.1. Barbeque Grills		D03.3.5. Renewable Heating/Cooling	
C07.2.2. Benches		D03.3.6. Solar Photovoltaic System	
C07.2.3. Bike Racks		D03.3.7. Solar Thermal System	
C07.2.4. Bike Lockers		D04. Building Entrances	88
C07.2.5. Bollards		D04.1. Primary Entrances	89
C07.2.6. Bus Shelters		D04.2. Secondary Entrances	89
C07.2.7. Drinking Fountains		D05. Wall Systems	90
C07.2.8. Dumpster Enclosures / Gates		D05.1. Hierarchy of Materials	91
C07.2.9. Fencing		D05.2. Layout, Organization and Durability	91
C07.2.10. Flagpoles		D05.3. Equipment, Vents and Devices	91
C07.2.11. Lighting – Landscape / Accent		D05.4 Wall Systems Materials	92
C07.2.12. Litter and Ash Receptacles		D05.4.1. Flat Metal Panels	
C07.2.13. Picnic Tables		D05.4.2. Brick Veneer	
C07.2.14. Planters – Free Standing		D05.4.3. Architectural Precast	
C07.2.15. Play Equipment		D05.4.4. Stucco Over Sheathing	
C07.2.16. Screen Walls		D05.4.5. Curtain Wall	
C07.2.17. Tree Grates		D05.4.6. Cast-in Place Concrete	
C07.2.18. Other		D05.4.7. Tilt-up Concrete	
C08. Exterior Signs	66	D05.4.8. Ribbed Metal Sheeting	
C08.1. Colors and Types	67	D05.4.9. EFIS	
C08.1.1. Materials and Color Specifications		D05.4.10. GRFC	
C08.1.2. Installation and Gate Identification Signs		D05.4.11. Concrete Block	
C08.1.3. Building Identification Signs		D05.4.12. Fiber Cement Siding	
C08.1.4. Traffic Control Devices (Street Signs)		D05.4.13. Other	
C08.1.5. Directional and Wayfinding Signs		D06. Doors and Windows	96
C08.1.6. Informational Signs		D06.1. Types	97
C08.1.7. Motivational Signs		D06.2. Layout and Geometry	97
C08.1.8. Parking Lot Signs		D06.3. Glazing and Shading	97
C08.1.9. Regulatory Signs		D06.4. Hardware	97
C08.1.10. Other		D06.5. Doors and Windows Materials	98
C09. Lighting	74	D06.5.1. Anodized Aluminum	
C09.1. Fixtures and Lamping	74	D06.5.2. Hollow Metal	
C09.2. Light Fixture Types	75	D06.5.3. Aluminum-clad Wood	
C09.2.1. Street Lighting		D06.5.4. Other	
C09.2.2. Parking Lot Lighting		D07. Roof Systems	101
C09.2.3. Lighted Bollards		D07.1. Roof Type and Form	102
C09.2.4. Sidewalk Lighting		D07.2. Roof Slope	102
C09.2.5. Walls / Stairs Lighting		D07.3. Parapets and Copings	103
C09.2.6. Other		D07.4. Color and Reflectivity	103
D. FACILITIES EXTERIORS	81	D07.5. Gutters, Downspouts, Scuppers, Drains	103
D01. Supporting the Mission	81	D07.6. Roof Vents and Elements	103
D02. Sustainability	81	D07.7. Clerestories and Skylights	104
D03. Architectural Features	82	D07.8. Vegetated Roof	104
D03.1. Orientation, Massing and Scale	83		
D03.2. Architectural Character	83		
D03.3. Details and Color	83		
D03.3.1. Climate-based Data			
D03.3.2. Natural Ventilation System			
D03.3.3. Thermal Mass			

Table of contents continued

D07.9. Roof Systems Materials	104	E04. Ceilings	129
D07.9.1. Standing Seam Metal		E04.1. Ceiling Materials	129
D07.9.2. Membrane Single-ply		E04.1.1. Exposed Framing (Roof / Floor Structure	
D07.9.3. Built-up Multi-ply		Above)	
D07.9.4. Concrete Tile		E04.1.2. Exposed Concrete	
D07.9.5. Clay Tile		E04.1.3. Grid and Acoustical Tile	
D07.9.6. Slate Shingles		E04.1.4. Gypsum Board	
D07.9.7. Vegetated System		E04.1.5. Metal Panels	
D07.9.8. Ribbed Metal Sheeting		E04.1.6. Wood	
D07.9.9. Composite Shingles		E04.1.7. Rapidly-Renewable Products	
D07.9.10. Other		E04.1.8. Other	
D08. Structural Systems	108	E05. Doors and Windows	132
D08.1. Systems and Layouts	109	E05.1. Doors and Windows and Frames Materials	132
D08.2. Structural Systems Materials	109	E05.1.1. Aluminum	
D08.2.1. Concrete		E05.1.2. Hollow Metal	
D08.2.2. Insulated Concrete Forming (ICF)		E05.1.3. Wood	
D08.2.3. Steel		E05.1.4. Other	
D08.2.4. Pre-Engineered Steel		E06. Casework Systems	136
D08.2.5. Masonry		E06.1. Casework Materials	136
D08.2.6. Heavy Timber		E06.1.1. Plastic Laminate	
D08.2.7. Light-gauge Steel		E06.1.2. Solid Polymer Surface	
D08.2.8. Lumber Framing		E06.1.3. Rapidly-Renewable Products	
D08.2.9. Other		E06.1.4. Metal	
D09. Mechanical, Electrical and Plumbing	113	E06.2. Countertop Materials	138
D09.1. Passive and Active Systems	114	E06.2.1. Plastic Laminate	
D09.2. Functionality and Efficiency	114	E06.2.2. Solid Polymer Surface	
E. FACILITIES INTERIORS	115	E06.2.3. Natural Stone	
E01. Building Configurations	116	E06.2.4. Cast Stone	
E01.1. Layout and Common Areas	116	E06.2.5. Metal	
E01.1.1. Interior Design Process		E07. Furnishings	140
E01.1.2. Codes and Regulations		E07.1. Durability and Serviceability	140
E01.2. Quality and Comfort	118	E07.2. Accessories	140
E02. Floors	118	E08. Interior Signs	140
E02.1. Floor Materials	118	E08.1 Types and Color	140
E02.1.1. Prepared Slabs		E08.2. Interior Signs Materials	140
E02.1.2. Natural Stone and Terrazzo		E09. Lighting, Power and Communication	140
E02.1.3. Quarry Tile		E09.1. Functionality and Efficiency	141
E02.1.4. Ceramic Tile		E09.2. Types and Color	141
E02.1.5. Resilient Floor		F. Appendices	142
E02.1.6. Carpet		G. Appendices	142
E02.1.7. Rapidly-Renewable Products			
E02.1.8. Other			
E03. Walls	124		
E03.1. Wall Materials	124		
E03.1.1. Concrete			
E03.1.2. Masonry			
E03.1.3. Ceramic Tile			
E03.1.4. Gypsum Board			
E03.1.5. Metal Panels			
E03.1.6. Wood Paneling			
E03.1.7. Rapidly-Renewable Products			
E03.1.8. Other			

A. OVERVIEW

Comply with Air Force Corporate Standards for Overview:

<http://afcfs.wbdg.org/index.html>

This Installation Facilities Standards (IFS) document is part of the Air Force Corporate Facilities Standards (AFCFS) program to assist bases in implementing and maintaining facilities standards as appropriate for efficient operations within the respective climate region. IFS fully replaces, consolidates and simplifies existing facilities standards documents, such as the Architectural Compatibility Plan (ACP) or ACGs, FEPs, etc., and organizes information using the same structure, or Table of Contents, as the AFCFS website.

IFS reflects the AFCFS' concepts of "Facility Hierarchy" (categorizing facilities into group numbers) and "Facility Quality" (assigning an appropriate level of quality to each group number) and applies these principles at the base level. Applicable DoD and Air Force criteria such as UFCs, AFIs, Memoranda, and UFGSs (Guide Specs) are referenced and linked within IFS to ensure the document is always current.

Navigating within this IFS is efficient and straightforward. Please use the interactive Table of Contents to locate subject matter, and click on the title of a section to access it. From any page, click on the "Back to Table of Contents" footer to return. Content is organized into 4 major sections: Installation Elements, Site Development, Facilities Exteriors and Facilities Interiors.

This IFS document begins as a fill-in PDF form, which is fully editable, and becomes a "living document" that can be regularly updated by base-level personnel following a format that is consistent across the Air Force. While the format is standardized, IFS content is customized for base operations and the local climate to ensure mission success while emphasizing reduced maintenance and reduced initial costs, life-cycle costs, energy use, and water use.

1. Conformance to Air Force Corporate Facilities Standards (AFCFS) and Installation Facilities Standards (IFS) are required by Air Force Instruction (AFI) 32-1023 and Air Force Memorandum. Please refer to the AFCFS website for links to documentation on current policy.
2. The IFS is a component plan of the Installation Development Plan (IDP) per Air Force Instruction (AFI) 32-7062 (replacing the Architectural Compatibility Plan). All military construction projects and Non-Appropriated Funds (NAF) facilities are required to comply with the IDP and its IFS component plan by AFI 32-1023. The Base Civil Engineer (BCE) maintains and implements the IDP and its component plans, to include the IFS.
3. Please refer to the AFCFS website as a portal to reference materials and requirements documents for design and construction projects (via links). Specific references to current DoD memoranda and Air Force criteria are updated periodically to provide the most current guidance and requirements. Programming, design and contract documents should list "current edition" for all reference and requirements documents. The documents in force at the date of execution of the design and/or construction contract shall be the governing version.
4. *Advanced Modeling Requirements:*
For all Air Force projects requiring advanced modeling, to include 3D visualization, Building Information Modeling (BIM), facility data, quantity take-off, geospatial, etc., follow the Army standards. Refer to USACE Minimum Model Matrix (M3) and Project Execution Plan (PxP) which outline required model uses. Refer to [CAD BIM Technology Center \(Contract Requirements\)](#) for more information on M3 and PxP.
5. Joint Bases shall implement IFS under their Joint-Base designation with volume numbers for individual installations following the IFS Development Tool template. For example, for Joint Base Langley-Eustis, provide: Vol. 1 Langley AFB and Vol. 2 Fort Eustis.

A.01. FACILITY HIERARCHY

Comply with AF Corporate Standards for Facility Hierarchy (and subsections):

<http://afcfs.wbdg.org/facility-hierarchy/index.html>

A.02. FACILITY QUALITY

Comply with AF Corporate Standards for Facility Quality (and subsections):

<http://afcfs.wbdg.org/facility-quality/index.html>

A.03. FACILITY DISTRICTS

Comply with AF Corporate Standards for Facility Districts (and subsections):

<http://afcfs.wbdg.org/facility-districts/index.html>

Image Tool 800 x 800

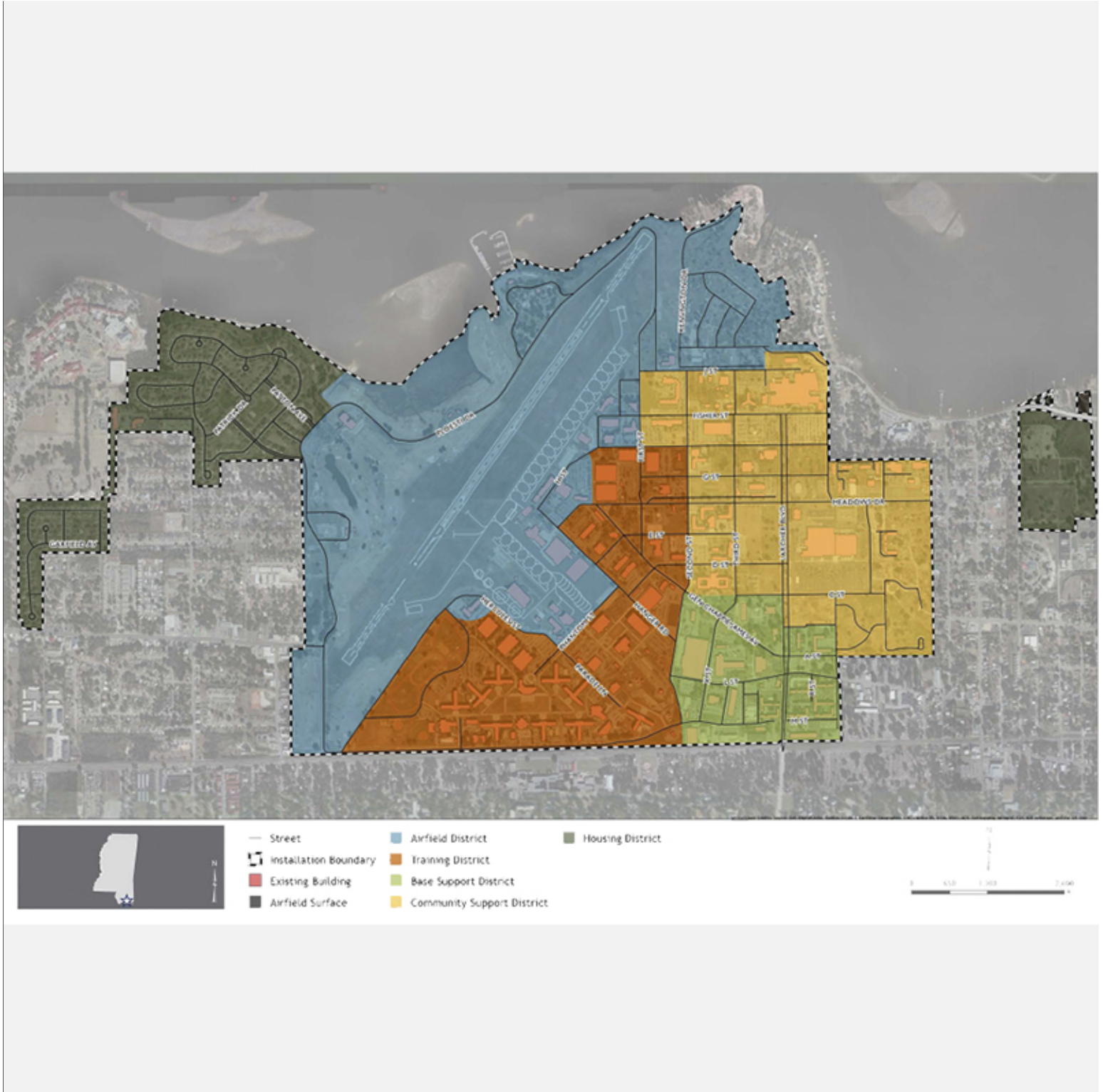

Note: Apply the base-wide standards in this IFS for Installation Elements, Site Development, Facilities Exteriors and Facilities Interiors (products, materials, color, etc.). Following application of the base-wide standards, refer to the Appendix and apply any additional requirements specifically related to the Facility District.

B. INSTALLATION ELEMENTS

Comply with Air Force Corporate Standards for Installation Elements:

<http://afcs.wbdg.org/installation-elements/index.html>

B.01. COMPREHENSIVE PLANNING

Comply with Air Force Corporate Standards for Comprehensive Planning:

<http://afcs.wbdg.org/installation-elements/comprehensive-planning/index.html>

B01.1. Installation Development Plan (IDP)

Applicable N/A Select number of graphics / images (large: 800 px x 440 px) to insert 1

Image Tool 800 x 440

Applicable N/A Small graphics do not apply

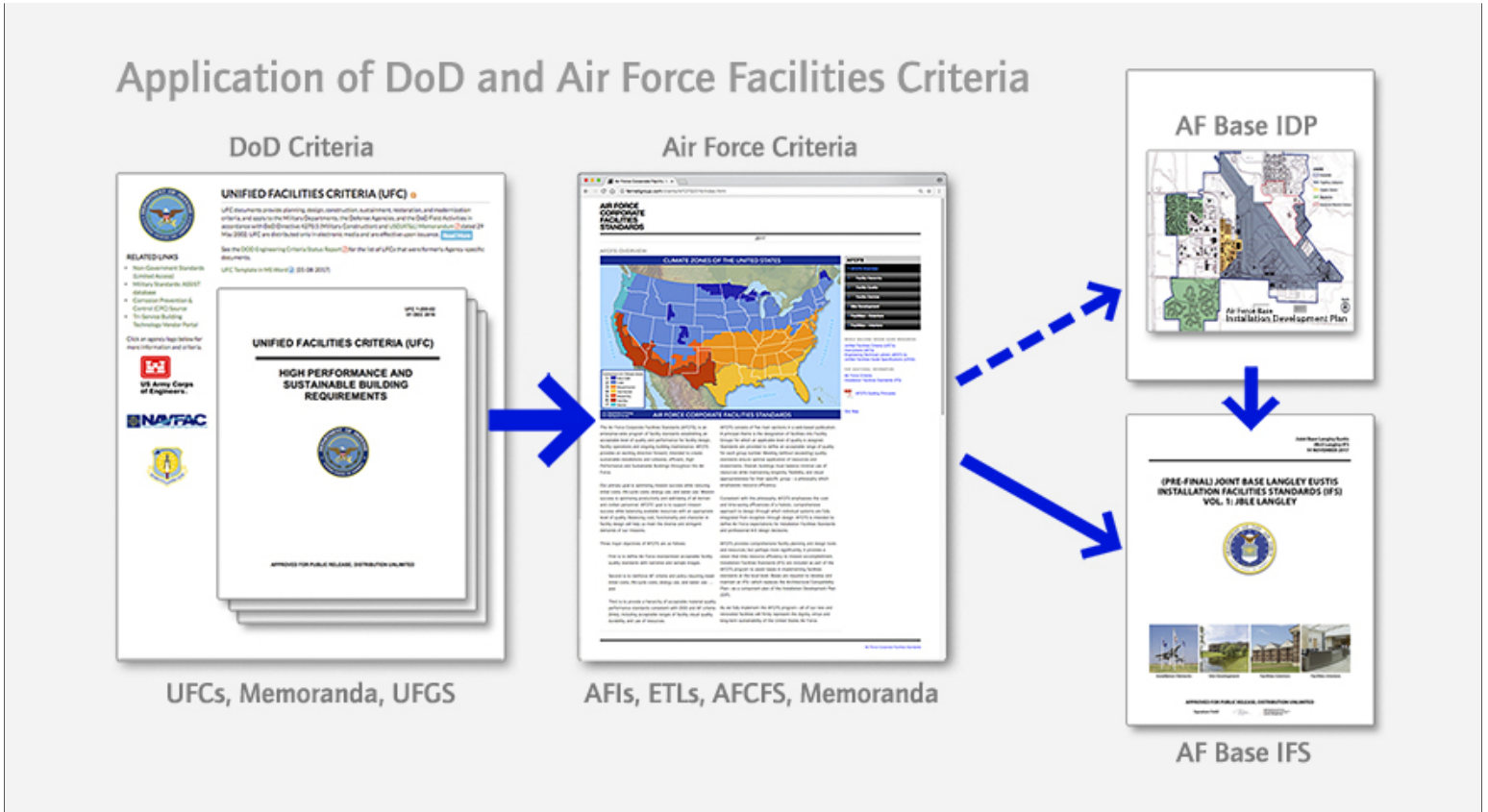

Department of Defense, Department of the Air Force and Air Force Base Criteria

1. The Base Civil Engineer is responsible for developing, maintaining and implementing the Installation Facilities Standards as a Component Plan of the base's installation's Development Plan (IDP).

B01.1.1. IFS Component Plan of IDP

Applicable N/A Select number of graphics / images (large: 800 px x 440 px) to insert 1

Image Tool 800 x 440

Applicable N/A Small graphics do not apply

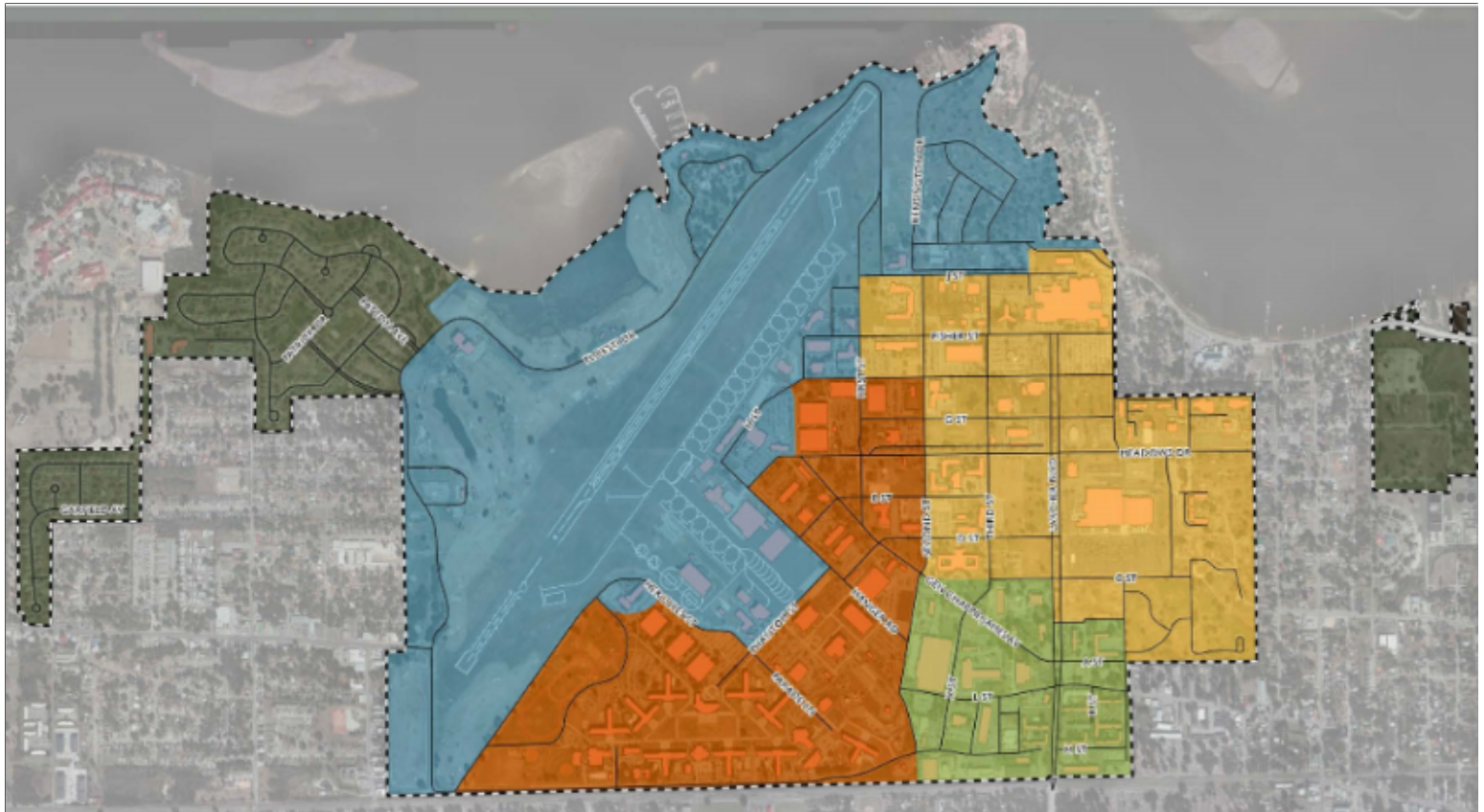

Land Use Diagram

1. Maintain this Installation Facilities Standards as a Component Plan of the base's Installation Development Plan (IDP).

B01.1.2. Brief History of Base

Applicable N/A Large graphics do not apply

Applicable N/A Select number of graphics / images (small: 250 px x 188 px) to insert 3

Image Tool 250 x 188



Historical Poster



Training at Keesler AFB, c. 1949



Student Housing in Background

Early Development: 1941 - 1949

In early January 1941, Biloxi city officials assembled a formal offer to invite the U.S. Army Corps to build a base to support the WWII training buildup. The package included an early airport, the old Naval Reserve Park, and parts of Oak Park sufficient to support a technical training school with a population of 5,200 people.

On 6 March 1941, the War Department officially notified Mayor Braun that Biloxi had been selected. The War Department activated Army Air Corps Station No. 8, Aviation Mechanics School, Biloxi, Mississippi, on 12 June 1941. City officials wanted the base named after a notable figure in the local area's history, but it was War Department policy to name installations after service members killed in action. In late June, Mayor Braun received word that the new school would be named in honor of 2d Lt Samuel Reeves Keesler, Jr., of Greenwood, Mississippi. Lieutenant Keesler had died of wounds during World War I while serving in France as an aerial observer assigned to the 24th Aero Squadron, U.S. Army Air Service. On 25 August 1941, Army Air Corps Station No. 8 was officially designated as Keesler Army Airfield.

First Soldiers Arrive

Captain Samuel A. Mundell arrived in Biloxi on 12 June 1941. He was joined two days later by a start up cadre from Scott Field, Illinois, consisting of a second lieutenant and 20 enlisted personnel; they established a temporary headquarters at the Biloxi Armory. Lieutenant Colonel William J. Hanlon arrived on 16 June to assume command from Captain Mundell. The same Arthur W. Brock who had first examined the site in January, now promoted to colonel, arrived on 17 July to become the base's first permanent commander.

On 8 September 1941, the 310th Technical School Squadron (the mess unit) became the first squadron to move to the new barracks. Before the end of the month, three basic training units, the 301st, 303d, and 304th Technical School Squadrons, had also moved into permanent quarters.

Basic Training

When the War Department activated Keesler Field in June 1941, the local community thought it was getting a technical training center with a student population, which might peak, at 20,000 people. Not only was Keesler to house a technical training center, but it would also host one of the Army's newest replacement, or basic training centers. Keesler's population almost doubled overnight.

The first shipment of recruits arrived at Keesler Field on 21 August 1941. During World War II, the Army's basic training program was upon specialized training in B-24 maintenance until mid-1944. Thereafter, the base was directed to expand its mechanics training curriculums to include other aircraft. Changing requirements forced the consolidation of all air-rescue training at Keesler in early 1945, however, and many of these programs had to be moved elsewhere for lack of facility space.

Specialized Flying Training

The rapid buildup of heavy bomber units overseas demanded additional aircrew, and Keesler was tasked to assist in the spring of 1944. A B-24 Copilot School began operation in July, and its curriculum was expanded to include B-32 copilot training in October. The need for B-24 crews had also diminished, and Keesler stopped training B-24 copilots two months later. In late July 1944, the Army Air Forces (AAF) consolidated all air-sea rescue training at Keesler. The situation worsened on 4 January 1945, when the AAF Training Command ordered Keesler to give first priority to air-sea rescue training. The Emergency Rescue School was disbanded in April 1946. Thereafter, air-sea rescue training passed to the Air Transport Command's newly established Air Rescue Service.

The Post World War II Era

In late May 1947, the AAF announced plans to move its Radar School from Boca Raton, Florida, to Keesler. The Radar School officially arrived on 14 November 1947, making Keesler responsible for operating the two largest military technical schools in the United States. Thereafter, shrinking budgets forced the base to reduce its operating costs: the Airplane and Engine Mechanics School and the Radar School were consolidated on 1 April 1948.

Meanwhile, in September 1947, the United States Air Force became an independent branch of the armed services. As a result, Keesler Field was officially redesignated as an Air Force base on 13 January 1948.

In early 1949, Air Training Command decided that Keesler should focus its efforts on teaching radar, radio, and electronics maintenance and repair. To make room, the airplane and engine mechanics courses had to be moved elsewhere. Especially since the Air Force also planned to transfer the Radio Operations School to Keesler from Scott AFB, Illinois. In addition to training radio operators, Keesler was to begin teaching air traffic service technicians; aircraft approach controllers, ground radar mechanics, and

radar repairman/ground controlled approach specialists. The last mechanics training courses had moved to Sheppard AFB, Texas, by November, and it was at this point in the base's history that Keesler became known as the "Electronics Training Center of the Air Force."

The Korean War and the Fifties: 1950 - 1959

In August 1950, Keesler embarked on a major rebuilding program to upgrade its facilities across the board. The first phase of this project called for the construction of a new electronics laboratory, barracks, and a dining hall for a total cost of \$14 million. In 1951, Congress appropriated an additional \$44 million to complete Keesler's reconstruction. Plans included four two-story academic buildings (later named Allee, Dolan, Thomson, and Wolfe Halls), a 352-bed hospital, modern family housing units, and a three-story dormitory complex dubbed "the triangle" because of its distinctive layout.

The 1950s also meant organizational change for Keesler. Since August 1948, the 3380th Technical Training Wing had controlled all base activities. Under it were four subordinate units: the 3380th Technical Training Group, which operated the school; the 3380th Maintenance and Supply Group; the 3380th Air Base Group; and the 3380th Medical Group. In 1955, a fifth group was added: the 3380th Installations Group. That arrangement continued until 1 January 1959, when Air Training Command redesignated the wing as Headquarters, Keesler Technical Training Center (KTTC). At the same time, the training group was redesignated as the 3380th Technical School, USAF, and all of its subordinate student squadrons were renamed school squadrons.

Technical Training

Keesler's modernization required more than expanded facilities. For example, Keesler began using television instruction methods as early as June 1953. In 1950, Keesler offered only 14 generalized courses, but by December 1959 that number had grown to 116, including vital USAF programs such as the aircraft warning and control system.

In early 1956, Keesler entered the missile age by opening a ground support training program for the SM-65 Atlas intercontinental ballistic missile. In addition, school personnel were developing training methods for the newly adopted semi-automatic ground environment (SAGE) system, an integrated defense net intended to protect the United States from Soviet air attack. The base gained even more responsibility in 1958, when the Air Force announced that Scott AFB would relinquish its training mission. As a result, all control tower operator, radio maintenance, and general radio operator courses came to be under Keesler's already broad technical training roof.

Technology in the Sixties and Seventies: 1960 - 1979

By 1960 the school at Keesler had earned a solid reputation for high technology training, offering courses in radar, communications, and electronics. During the early 1960s, Keesler lost many of its airborne training courses, and the aircraft they required. The TC-54s assigned to electronic warfare officer training departed for Mather AFB, California, in April 1961. In December 1962, the Air Ground Operations School and its T-33s transferred to Eglin AFB, Florida; they had filled Biloxi's airspace with jet noise since 1957. The last C-47 used for airborne ground approach radar training left in 1966, when it was replaced by an ground-based simulator.

Keesler remained the largest training base within ATC throughout the 1970s, and it continued to stay on the cutting edge of electronics technology, instructing students in new systems such as the worldwide military command and control system and the 407L radar system. The school was the country's main supplier of electronics technicians.

Keesler's student load dropped to an all-time low after the Vietnam War ended, and Air Force officials responded to changing social conditions by reexamining the school's teaching functions. As a result, Air Training Command inactivated the USAF School of Applied Aerospace Sciences on 1 April 1977 and replaced it with the 3300th Technical Training Wing, which activated the same day.

The End of the Cold War and Beyond: 1980 - 1999

Two weapon systems training programs gained attention during the early 1980s. One was the airborne warning and control system (employed aboard the E-3A Sentry aircraft), and the other was the BGM-109 ground-launched cruise missile. Keesler's air traffic control program also garnered its share of publicity - especially after the Professional Air Traffic Controllers Organization walked off the job in August 1981. When President Ronald Reagan fired the strikers, it was Keesler-trained military air traffic controllers who stepped in to keep the nation's airways flowing smoothly.

Beginning in 1984, school officials worked with Air Force Communications Command's 1872d School Squadron to develop prototype-training programs using interactive videodisc (IVD) technology, which soon supported a variety of Keesler interactive course offerings. Keesler's Wall Studio IVD production capability was one of only two in the entire Air Force, and supported many organizations Air Force wide.

Driven by deep defense budget cuts, the congressionally mandated base realignment and closure process culminated in a major downsizing effort, significantly impacting Keesler's training mission. With base closure forcing an end to technical training at Chanute AFB, Illinois, and Lowry AFB, Colorado, Keesler's growing importance as a technical university would become even more firmly fixed. The first additions arrived in 1990, as Keesler acquired Chanute's weather forecasting courses. Lowry's metrology and precision maintenance electronics laboratory training program followed in 1992-1993.

The Air Force's 1992 "Year of Training" initiatives - a top to bottom reevaluation of the process by which USAF technicians acquired and honed their skills - led to a host of organizational changes. One initiative proposed a draw down of USAF field training detachments (FTD). These detachments were the mechanism by which USAF maintainers Still in the planning stages in 1995, the FTD draw down initiative would divide weapon systems training among the major using commands and the technical training centers, and Keesler stood to inherit many new course responsibilities once the draw down plan went into effect.

Another Year of Training initiative resulted in the return of flying training to Keesler for the first time since 1973. Tasked with providing operational airlift support training to pilots in C-12C/F Huron and C-21A Learjet aircraft, the 45th Airlift Squadron was assigned to the 81st Training Group. It began operations in July 1994.

Meanwhile, the massive restructuring of the Air Force in the early 1990s also meant several changes for Keesler's associate units. The first occurred when the 53d Weather Reconnaissance Squadron (known throughout the Gulf region as the Hurricane Hunters) was inactivated and transferred to the reserves on 30 June 1991. Its important mission was merged with the storm-tracking mission of the 815th WRS, a component of the 403d Wing, Keesler's resident Air Force Reserve unit that includes the 815th Airlift Squadron that also flies C-130s. Another base tenant change occurred when the 7th Airborne Command and Control Squadron and its EC 130 flying command post aircraft relocated to Davis-Monthan AFB, Arizona, in September 1994.

Those restructuring efforts similarly affected units assigned to Keesler Technical Training Center. In February 1992, Air Training Command redesignated the base's host unit as the Keesler Training Center (KTC). The 3300th Technical Training Wing was downsized to become a group, and its component technical training groups became squadrons. The 3305th Student Group also inactivated along with its subordinate squadrons. In mid-September all of the 3380th numbered units assumed the 393d designation, as the base further realigned itself to conform to the Air Force's objective wing structure. In addition, the technical training group also assumed the 393d designation, and its nine technical training and training support squadrons were renumbered to better reflect the new, simplified organizational arrangement.

Yet another major change occurred on 1 July 1993, when Keesler Training Center inactivated, and its lineage and honors retired. On the same day, the 81st Tactical Fighter Wing, formerly located at RAF Bentwaters, United Kingdom, was redesignated the 81st Training Wing and concurrently activated to serve as Keesler's host organization. At the same time, HQ USAF redesignated Air Training Command as Air Education and Training Command (AETC), and the command activated Second Air Force and stationed it at Keesler. Its mission was to oversee all technical training conducted within AETC.

B01.1.3. Future Development

Applicable N/A Select number of graphics / images (large: 800 px x 440 px) to insert 1

Image Tool 800 x 440

Applicable N/A Small graphics do not apply

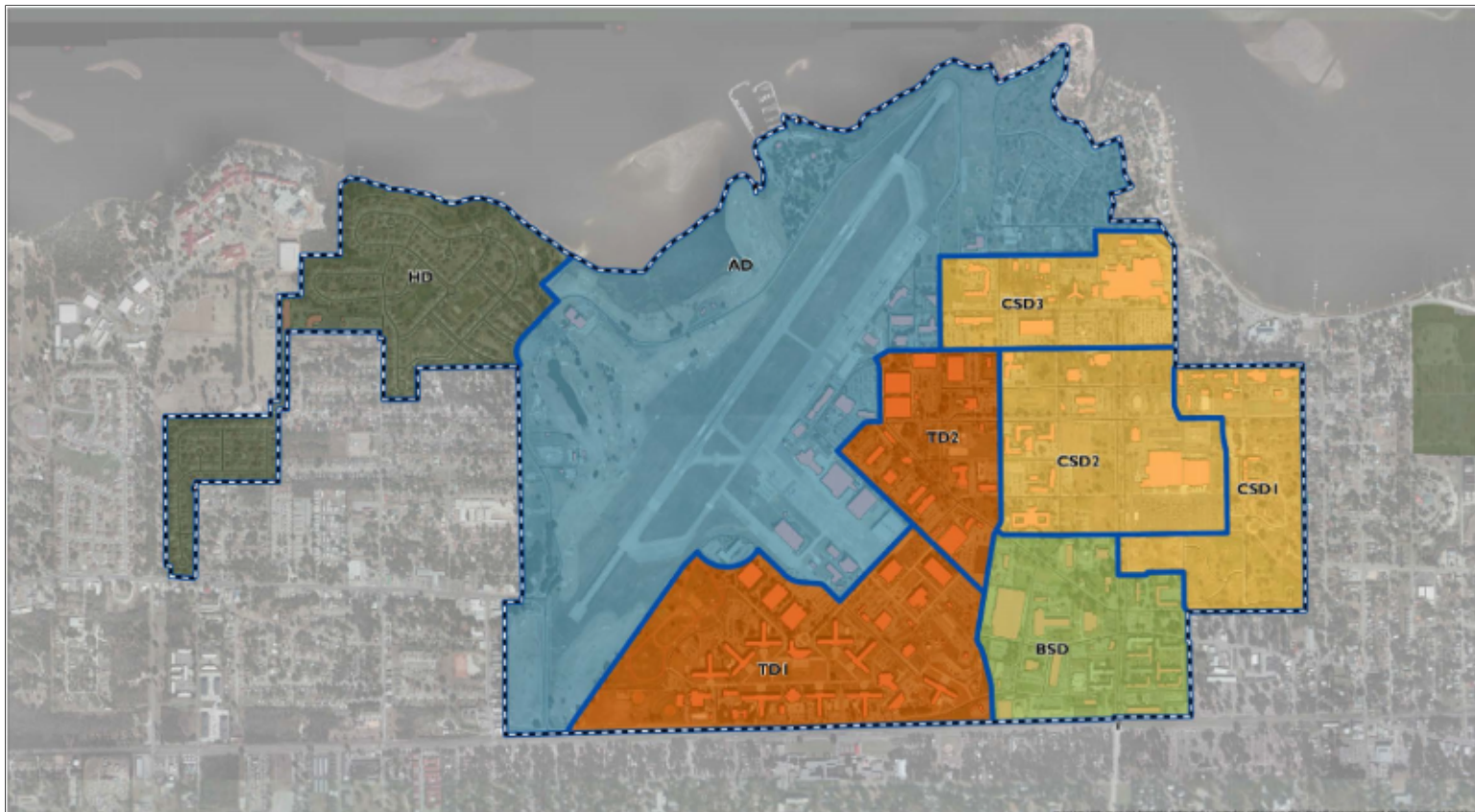

Future Development Districts Legend

1. Follow AFI 32-7062 for Air Force Comprehensive Planning, the Comprehensive Planning Process, Comprehensive Planning Requirements, and Geospatial Mapping.
2. Address all future development under the Installation Development Plan (IDP).
3. Future Development Districts at Keesler AFB include: AD- Airfield District, TD1- Training District/ Training Triangle, TD2- Training District/ Academic Buildings, BSD- Base Support District, CSD1-Community Support District, CSD2-Community Support District/ Downtown Keesler, CSD3- Community Support District/ Medical and Administrative, HD- Family Housing District.

B02. STREET ENVELOPE STANDARDS

Comply with Air Force Corporate Standards for Installation Elements:

<http://afcs.wbdg.org/installation-elements/index.html>

Comply with AF Corporate Standards for Street Envelope Standards:

<http://afcs.wbdg.org/installation-elements/street-envelope-standards/index.html>

B02.1. Hierarchy of Streets

Applicable N/A Select number of graphics / images (large: 800 px x 440 px) to insert 1

Image Tool 800 x 440

Applicable N/A Select number of graphics / images (small: 250 px x 188 px) to insert 3

Image Tool 250 x 188



Keesler Air Force Base Primary streets are denoted in red and secondary streets are denoted in green

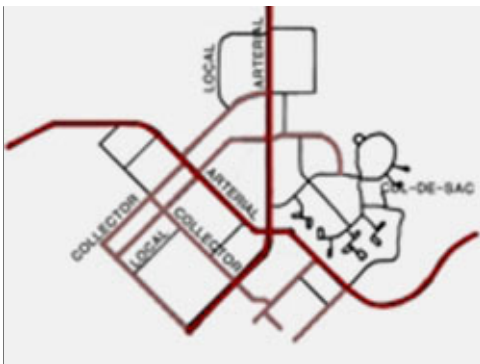

Hierarchy of Streets

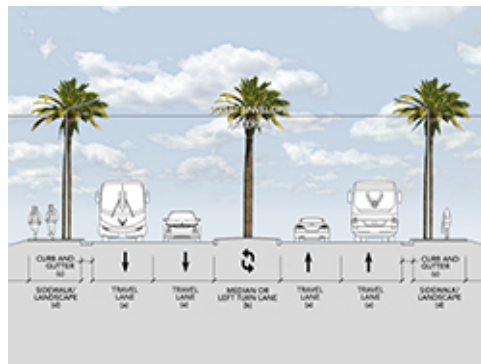

Street Envelope Section



Avenue of Flags

1. Develop and evolve a hierarchical transportation network of arterial, collector and local streets following UFC 3-201-01 and its industry references.
2. Provide consistent functionality throughout the installation and a level of visual quality relating to the adjacent Facility Group number.
3. Routes along facilities in Group 1 may have materials, finishes and features with a higher visual quality than Groups 2, 3 and 4. Reduce maintenance requirements by installing highly durable materials and finishes in routes along Group 3 industrial facilities.

4. Special routes may have a visual quality comparable to those along facilities in Group 1.
5. Create and maintain arterials with two lanes of traffic in each direction with landscaped or paved medians as applicable to the local climate and adjacent facility group designation / land use.
6. Minimize stops and turns along arterials. Eliminate on-street parking along arterials and collector streets.
7. Connect arterials to local streets with appropriately scaled collector streets.
8. Provide appropriate landscape setbacks and pedestrian buffers along all streets.
9. Minimize and consolidate curb cuts along streets.
10. Ensure access for emergency and service vehicles.
11. Define bicycle traffic routes in the Installation Development Plan or its applicable component plans.
12. Provide illustrations in the Installation Facilities Standards (IFS) to include street cross-sections and plans for every type of street specified on the installation. At a minimum provide dimensions for vehicular traffic-lanes, curb radii, medians, bike lanes, pedestrian buffers, sidewalks, crosswalks, tree planting areas, and on-street parking configurations.
13. Define appropriate force protection features, site furnishings, signs, lighting, utilities, and paving in the IFS.

B02.1.1. Arterial Streets

Applicable N/A Select number of graphics / images (large: 800 px x 440 px) to insert 1

Image Tool 800 x 440

Applicable N/A Select number of graphics / images (small: 250 px x 188 px) to insert 1

Image Tool 250 x 188

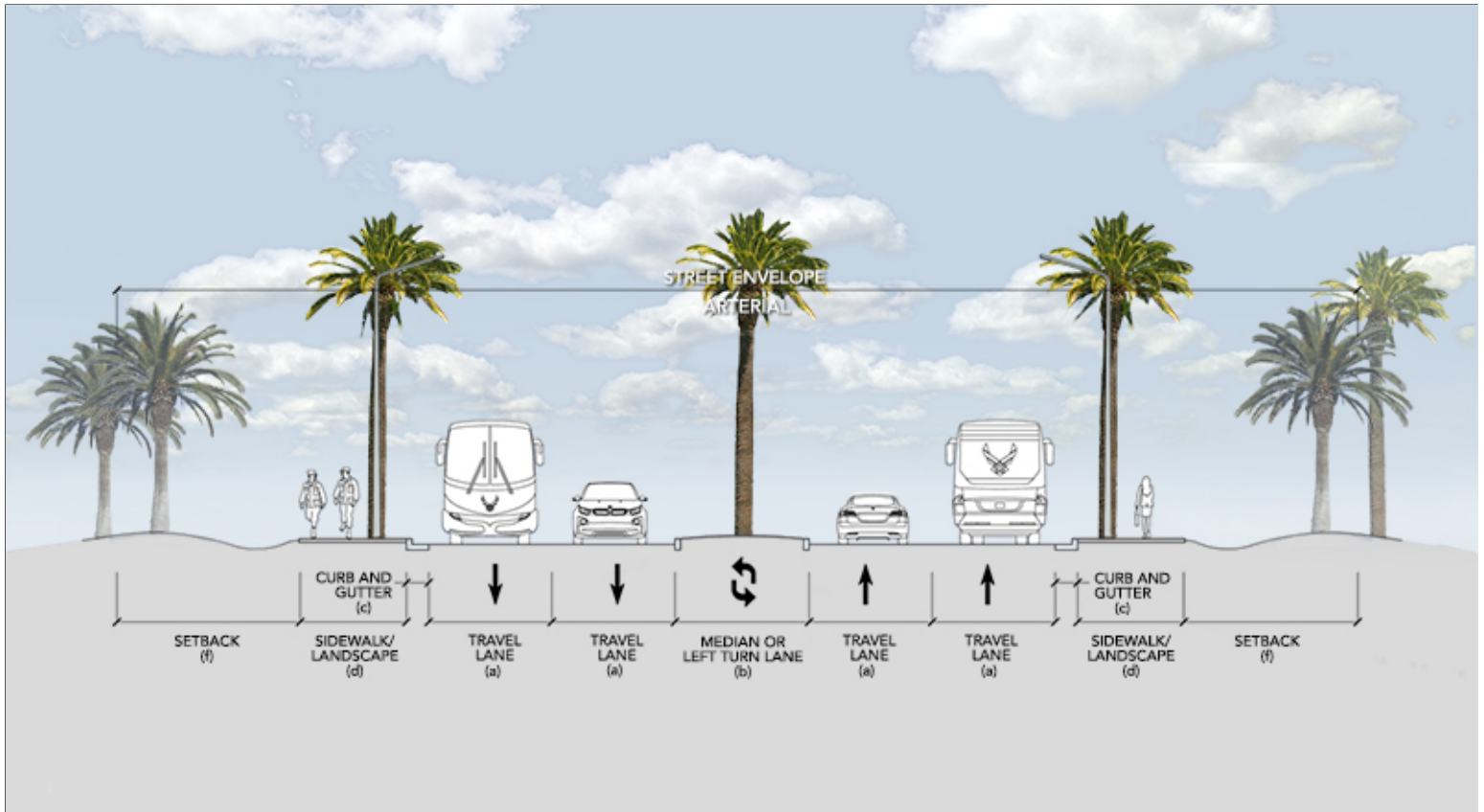

Travel Lane (a): 12' Median (b): 12' Curb and Gutter (c): 2' Sidewalk / Landscape (d): 12' Setback (f): Min. 35' or per ATRP

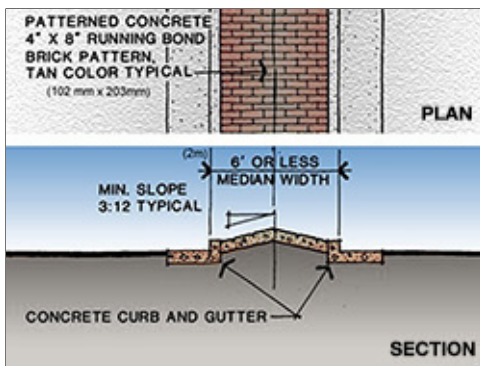

Paved Median

1. Stops and turns should be minimized and on-street parking shall not be allowed at any point along arterial streets.
2. Provide sidewalks on at least one side of arterial streets and both sides of arterial streets in developed areas. Provide a 6 foot buffer between the road and sidewalk where space allows.
3. Limit curb cuts on arterial streets to entries into major facilities, building groups and major parking areas.
4. Reinforce the importance of arterial streets with appropriate signs, plantings and street lighting.

B02.1.2. Collector Streets

Applicable N/A Select number of graphics / images (large: 800 px x 440 px) to insert 1

Image Tool 800 x 440

Applicable N/A Small graphics do not apply

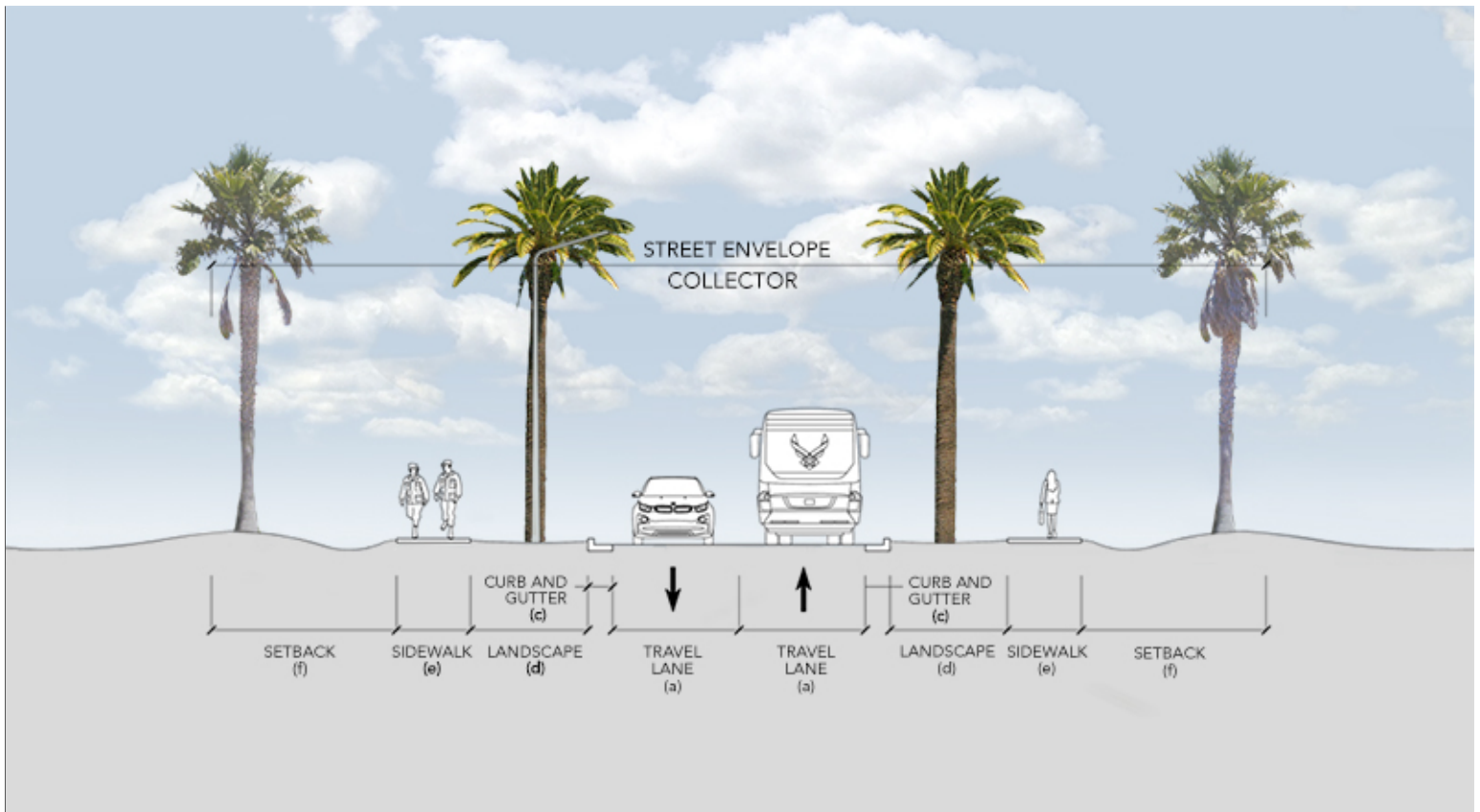

Travel Lane (a): 12' Median (b): N/A Curb and Gutter (c): 2' Landscape (d): 10' Sidewalk (e): 6' Setback (f): Min. 35' or per AFTP

1. Provide sidewalks on at least one side of collector streets and both sides of collector streets where functionally required. Buffers are preferred but not required on collector streets.
2. On street parking may be allowed on one side where secondary roads are over 28 feet wide but not less than 34 feet wide. Parking shall not interfere with intersections or traffic flow.
3. Signs, plantings and street lighting should reinforce the designation of "collector" street.

B02.1.3. Local Streets

Applicable N/A Select number of graphics / images (large: 800 px x 440 px) to insert 1

Image Tool 800 x 440

Applicable N/A Small graphics do not apply

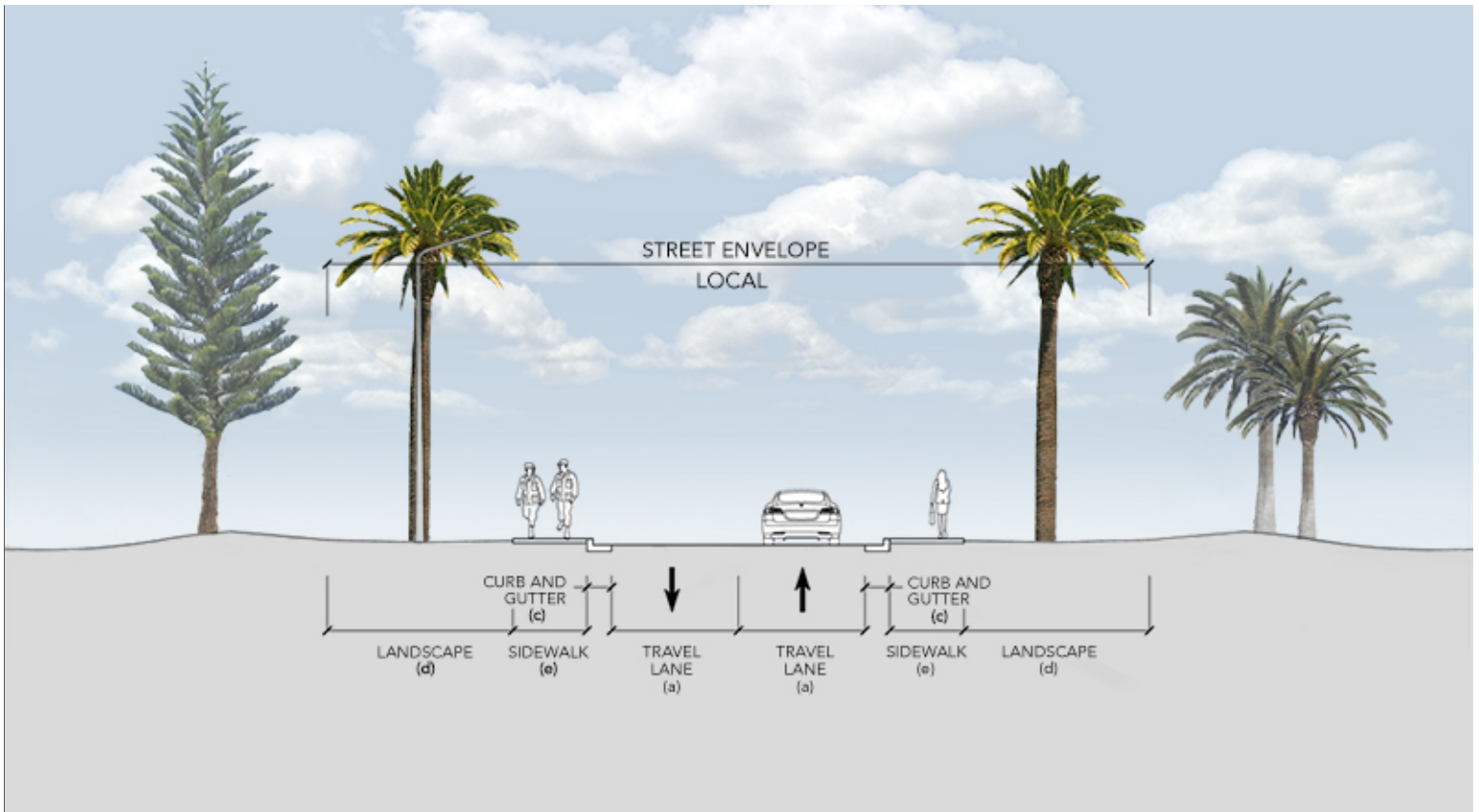

Travel Lane (a): 11' Median (b): N/A Curb and Gutter (c): 1.5' Landscape (d): 15' Sidewalk (e): 6'

1. Provide sidewalks on at least one side of collector streets and both sides of local streets where functionally required. Buffers are preferred but not required on collector streets.
2. On street parking may be allowed following UFC industry references.
3. Signs, plantings and street lighting should reinforce the designation of "local" street.
4. Cul-de-sacs are only permitted in family housing areas.

B02.1.4. Special Routes

Applicable N/A Select number of graphics / images (large: 800 px x 440 px) to insert 1

Image Tool 800 x 440

Applicable N/A Small graphics do not apply



Setbacks on Larcher Boulevard are a minimum of 50', which include a 12' sidewalk.

1. Develop all special routes consistently with those adjacent to Group 1 facilities.

B02.2. Hierarchy of Intersections

Applicable N/A Large graphics do not apply

Applicable N/A Small graphics do not apply

1. Provide a hierarchy of intersections to include arterial, arterial-collector, collector, collector-local and local following UFC 3-201-01 and its industry references.
2. Passive systems such as traffic circles are preferred to active systems such as signalized intersections. Aggressively pursue passive systems to lower maintenance requirements and reduce energy use.
3. Use a level of visual quality for an intersection equal to the quality found in the related streetscape, which corresponds to the adjacent Facility Group number.

B02.2.1. Arterials

Applicable N/A Select number of graphics / images (large: 800 px x 440 px) to insert 1

Image Tool 800 x 440

Applicable N/A Small graphics do not apply



Avenue of Flags on Larcher Blvd

1. Provide an informal grouping of low lying native ground cover and shrubs with trees as a backdrop at all four corners. Monuments and static displays may be integrated into arterial intersection designs.

B02.2.2. Arterial/Collector

Applicable N/A Large graphics do not apply

Applicable N/A Select number of graphics / images (small: 250 px x 188 px) to insert 2

Image Tool 250 x 188

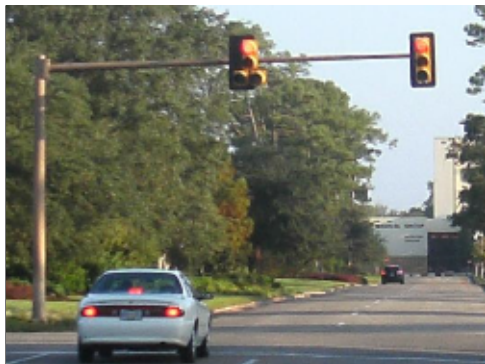

Northbound on Larcher Blvd at Meadows Dr



Northbound on Larcher Blvd at Fisher St

1. Provide an informal grouping of low lying native ground cover and shrubs with trees as a backdrop at all four corners.

B02.2.3. Collectors

Applicable N/A Large graphics do not apply

Applicable N/A Select number of graphics / images (small: 250 px x 188 px) to insert 3

Image Tool 250 x 188



Westbound Meadows Dr at Third St



Southbound X St at L St



Eastbound Ploesti Dr at Hercules Dr

1. Provide an informal grouping of low lying native ground cover and shrubs with trees as a backdrop at all four corners.

B02.2.4. Special Intersections

Applicable N/A Large graphics do not apply

Applicable N/A Small graphics do not apply

1. Develop all special intersections consistently with those adjacent to Group 1 facilities

B02.2.5. Street Frontage Requirements

Applicable N/A Large graphics do not apply

Applicable N/A Small graphics do not apply

1. Consistently maintain open space buffers following B03.2.3. Preserves.
2. Refer to C06.1.7. Streetscape Landscaping for planting and screen wall requirements along street frontage.

B02.2.6. Sight Lines

Applicable N/A Large graphics do not apply

Applicable N/A Small graphics do not apply

1. Provide adequate sight lines for an effective and safe traffic operation per American Association of State Highway and Transportation Officials (AASHTO) standards and local municipality guidelines.

B02.3. Street Elements

Applicable N/A Large graphics do not apply

Applicable N/A Small graphics do not apply

1. Emulate the streetscape area's pre-development hydrology using passive and active design features to help sustain the adjacent regionally appropriate landscape. Coordinate with the base Stormwater Management Plan.
2. Employ systems, materials and techniques to maximize streetscape sustainability. Consider pervious paving and reflectivity of surfaces appropriate for the local climate.
3. Install at-grade curbing and/or raised-profile curb and gutter as applicable to direct stormwater to bioswales and rain gardens as source water for vegetation. Do not paint concrete curbing.
4. Provide all on-site utility service lines and equipment below grade when adjacent to Facility Group 1. In routes along Group 2, 3 and 4, when mounting elements such as utility cabinets, communications equipment and water valves above grade is unavoidable, paint these consistently and provide visual screening following Installation Facilities Standards (IFS).
5. Provide traffic control devices including access control point/entry control facility signs, speed limit signs and street name signs following the current edition of the Manual on Uniform Traffic Control Devices (MUTCD) per UFC 3-120-01.
6. Follow UFC 3-120-01 for directional and wayfinding signs and address both vehicular and pedestrian traffic.
7. Reduce energy consumption and reduce maintenance requirements by providing street lighting only when functionally required to ensure safety and to address antiterrorism following UFC 4-010-01. Ensure the quality and quantities of lighting and fixtures are appropriate for the adjacent Facility Group number.

B02.3.1. Paving

Applicable N/A Large graphics do not apply

Applicable N/A Small graphics do not apply

1. Pavement design shall comply with UFC 3-250-01. Ensure appropriate analysis and design of subgrade conditions to promote low maintenance, high performance pavements. Apply all applicable best practices from Appendix B of the UFC.
2. Materials shall be specified in accordance with UFC 3-250-01 and must conform to requirements set forth in the Unified Facility Guide Specifications (UFGS) for concrete and bituminous pavement.

B02.3.2. Curb and Gutter

Applicable N/A Large graphics do not apply

Applicable N/A Select number of graphics / images (small: 250 px x 188 px) to insert 2

Image Tool 250 x 188

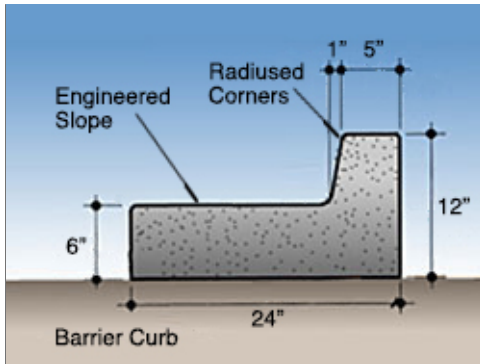

Base Standard Curb

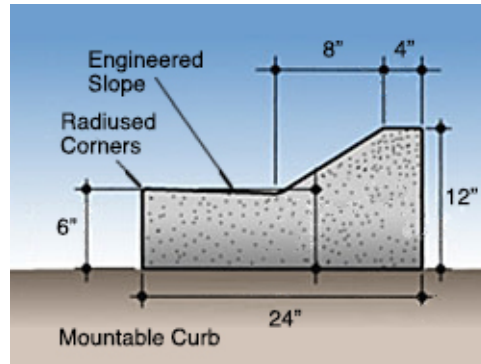

Mountable Curb for Group 4 Family Housing

1. Curb all parking, access roads and streets (except remote/isolated).
2. All streets should have integral concrete curbs and gutters. Painted curbs are prohibited because they are very difficult to maintain.
3. Use concrete for sidewalks and curbs. Do not use asphalt curbs.

B02.3.3. Utility Service Elements

Applicable N/A Large graphics do not apply

Applicable N/A Small graphics do not apply

1. Provide all utility service lines below grade when streets are adjacent to Facility Group 1; when mounting elements (such as utility cabinets, communications equipment and water valves) above grade is unavoidable, paint these consistently and provide visual screening following Site Development, Landscaping.
2. Overhead service lines along streets adjacent to Facility Groups 2, 3 and 4 are discouraged.

B02.3.4. Traffic Signs

Applicable N/A Large graphics do not apply

Applicable N/A Small graphics do not apply

1. Refer to Exterior Signs, Colors and Types for Traffic Control Devices, which includes signs.

B02.3.5. Street Lighting

Applicable N/A Large graphics do not apply

Applicable N/A Select number of graphics / images (small: 250 px x 188 px) to insert 2

Image Tool 250 x 188



Decorative LED Street Lighting



LED lights on Hercules Dr

1. Refer to the Lighting section for appropriate applications along streets.

B02.3.6. Other

Applicable N/A Large graphics do not apply

Applicable N/A Small graphics do not apply

B03. OPEN SPACE / PUBLIC SPACE

Comply with Air Force Corporate Standards for Installation Elements:

<http://afcs.wbdg.org/installation-elements/index.html>

Comply with AF Corporate Standards for Open Space / Public Space:

<http://afcs.wbdg.org/installation-elements/open-space-public-space/index.html>

B03.1. Plazas, Monuments and Static Displays

Applicable N/A Large graphics do not apply

Applicable N/A Select number of graphics / images (small: 250 px x 188 px) to insert 2

Image Tool 250 x 188



Troopwalk at Training Triangle



Troopwalk at Training Triangle

1. Natural features and culturally or historically significant features or events may be recognized and acknowledged with physical elements such as plazas, monuments and static displays. However, limit these elements on the base to ensure judicious use of resources and to reduce ongoing maintenance requirements.
2. Design highly durable plazas, monuments and static displays with a level of quality comparable to Facility Group 1.
3. Link plazas, monuments and static displays to the pedestrian circulation system. Install landscaping, site furnishings and lighting appropriate for the application and local climate following Installation Facilities Standards (IFS).
4. Select systems, products and materials for paving, walls, and structures following IFS.

B03.1.1. Paved Plazas

Applicable N/A Large graphics do not apply

Applicable N/A Small graphics do not apply

1. Mitigate heat island by providing high-albedo, shaded plazas. Pervious pavers shall be used on all plazas and courtyards in Facility Groups 1 and 2; use pervious concrete in Groups 3 and 4. The designer shall incorporate appropriate expansion and construction joints.
2. Pavers shall match the color of pavers used on adjacent sidewalks using base standard range of colors. Bricks used on plazas shall typically be 4" x 8" size.

B03.1.2. Sculptures, Markers and Statuary

Applicable N/A Large graphics do not apply

Applicable N/A Select number of graphics / images (small: 250 px x 188 px) to insert 1

Image Tool 250 x 188



Sculpture as a Focal Point

1. Relate new sculpture, markers and statuary to the base's architectural design theme. Generally limit these elements to frequently used locations adjacent to Facility Group 1 and highly traveled community pedestrian spaces.
2. Consider entry gates as possible sites for new displays.
3. All proposed memorials shall follow AFI 36-3108 and be limited to highly deserving individuals or groups as deemed appropriate by the installation leadership. Living memorials (tree plantings / etc.) are discouraged due to added maintenance requirements.
4. When sculpture requires a base, match the materials and / or color palette of adjacent buildings.
5. Use direct or indirect lighting to accentuate features or enhance an intended effect.
6. Ensure that all sculpture, markers and statuary are honorable and inspiring, provide a sense of place, positively contribute to the base's visual quality, and encourage pride for the community and the US Air Force.

B03.1.3. Static Display of Aircraft

Applicable N/A Large graphics do not apply

Applicable N/A Select number of graphics / images (small: 250 px x 188 px) to insert 2

Image Tool 250 x 188



Dynamic Positioning



Low-Level Mounting

1. Follow IFS base-wide standards for all elements of the display area with specific attention to traffic sight lines, pedestrian circulation, site furnishings, signs, and lighting. Address requirements for the Facility District as well.
2. Generally locate concrete base/foundation structures for static displays below grade.
3. At static displays where pedestrian paths are provided, a minimum of one trash receptacle and one bench shall be provided. Receptacle and bench design must conform to IFS requirements.
4. Displays and signs must be designed and constructed in conformance with AFI 84-103.
5. Relocation of existing static displays requires approval from MAJCOM/HO and NMUSAF.

B03.2. Grounds and Perimeters

Applicable N/A Large graphics do not apply

Applicable N/A Small graphics do not apply

1. Provide formal spaces for parade and review functions, recreational areas and parks following the base's Installation Development Plan (IDP) and Installation Facilities Standards (IFS). Refer to the Site Furnishings topic for additional information.
2. Maintain preservation areas following the IDP and IFS.
3. Comply with UFC 4-010-01 DoD Minimum Antiterrorism Standards for Buildings and UFC 4-022-03 Security Fences and Gates for all elements associated with the base's gates and perimeter fence.
4. Identify and describe base-wide utility corridors in the IDP.
5. Base-wide utility infrastructure shall be inconspicuous. Bury utility service lines below grade when adjacent to Facility Group 1 and when economically feasible for Facility Groups 2, 3 and 4. When service lines are located above grade, create an ordered, coordinated appearance.
6. Follow the requirements of this IFS regarding all utility structures and service lines located above grade that visually impact the installation.

7. Where screening of utility equipment and structures is provided, allow adequate and proper clearance for safety and maintenance.
8. Reduce visual clutter and visual impact of the following items through a combination of careful placement, screen walls, landscaping and painting:
 - Electrical switch-stations.
 - Sewage lift stations.
 - Water well pumps, storage tanks and/or related structures.
 - Gas piping, meters and similar incidental items.
 - Above ground fuel storage tanks.
 - Any ground-mounted freestanding utility item exposed to view.
9. Larger structures such as electrical switch-stations, sewage lift stations, fuel storage tanks and mechanical/electrical equipment shall be screened from view, using materials, forms, and colors in the screen walls which match those respective design elements present at adjacent buildings.
10. Paint above-ground equipment and associated components such as electrical piping or exposed plumbing lines dark bronze.
11. Maintain currently buried utility service lines as a visual asset.
12. Bury the following exposed above-grade items in future projects when economically feasible:
 - Electrical power grid and service lines.
 - Telephone lines.
 - Cable TV lines.
 - Communications lines.
 - Exterior lighting service lines.
 - Any similar system of above-ground lines serving the base.
13. Consolidate and enclose service utility lines in underground utility corridors when feasible. Create routes along the inside edge of parking lot islands.

B03.2.1. Parade Grounds

Applicable N/A Select number of graphics / images (large: 800 px x 440 px) to insert 1

Image Tool 800 x 440

Applicable N/A Small graphics do not apply



Actively Utilized Parade Ground

1. Follow UFC 3-201-02, Appendix B for the planning and design process and criteria for parade grounds.
2. Establish and maintain parade grounds only where there is a confirmed need and provide landscape materials appropriate for the locale following IFS.
3. Bleachers may be installed only when there is a documented requirement at parade grounds. Nonferrous metals that do not require painting or going maintenance are preferred. The Base Civil Engineer shall determine quantities, sizes, and products on a case basis.

B03.2.2. Parks

Applicable N/A Select number of graphics / images (large: 800 px x 440 px) to insert 1

Image Tool 800 x 440

Applicable N/A Select number of graphics / images (small: 250 px x 188 px) to insert 3

Image Tool 250 x 188



Neighborhood Park Setting



Typical Picnic Pavilion



Standard Park Structures



Integrated Site Furnishings

1. Bleachers may be installed only when there is a documented requirement at parks and fields for recreational events. Follow guidance under Parade Grounds.
2. Picnic pavilions may be provided in parks where there is a documented need.
3. Maintain Live Oak Trees in Marina Park as a cultural resource.

B03.2.3. Preserves

Applicable N/A Select number of graphics / images (large: 800 px x 440 px) to insert 1

Image Tool 800 x 440

Applicable N/A Small graphics do not apply



Preserve Area along Back Bay of Biloxi

1. Preserve areas adjacent to runways, taxiways, aprons, golf course roughs, storage areas, antenna facilities, and ammunition storage areas, as open space.
2. Provide minimal maintenance with mowing as needed for controlling bird behavior for airfield safety, or eliminating fire hazards.

B03.2.4. Perimeter Fence

Applicable N/A Large graphics do not apply

Applicable N/A Select number of graphics / images (small: 250 px x 188 px) to insert 1

Image Tool 250 x 188



Base Standard Metal Fencing

1. Design, install and maintain the base's perimeter fence following UFC 4-022-03.
2. Stringently comply with ATFP requirements following UFC 04-010-01 for all spaces adjacent to the base's perimeter fence and all gates.
3. Fencing, gates and other elements that are associated with the main gates shall be a level of quality equivalent to Facility Group 1.
4. Maintain a positive visual quality along the traffic corridor on both sides of the main gates. Specifically address pedestrian access, circulation and common areas.

C. SITE DEVELOPMENT

Comply with Air Force Corporate Standards for Site Development:
<http://afcs.wbdg.org/site-development/index.html>

C01. SITE DESIGN

Comply with Air Force Corporate Standards for Site Development:
<http://afcs.wbdg.org/site-development/index.html>

Comply with AF Corporate Standards for Site Design / NEPA:
<http://afcs.wbdg.org/site-development/site-design-nepa/index.html>

C01.1. Site Design Considerations

Applicable N/A Large graphics do not apply

Applicable N/A Small graphics do not apply

1. Collect documentation to validate approvals and completion of the NEPA process.
2. Ensure site design compliance with the Installation Development Plan (IDP) and its component plans and Installation Facilities Standards (IFS).
3. Promote integrated design with on-site solutions such as engineered small-scale hydrologic controls versus base-wide infrastructure; consider open space, natural features, bioswales, building roofs, streets, and paved surfaces.
4. Limit the impact of development on land and water resources. All site elements and infrastructure shall reinforce an image of sustainability, with reduced energy demand, renewable-energy usage, and water conservation.
5. Consider energy conservation during site design for the following categories: building and site lighting, auxiliary systems and equipment (refrigerators, elevators, etc.), building envelope, electric power and distribution, HVAC systems and equipment, service hot water, energy management (metering, EMCS).
6. Coordinate on-site renewable-energy systems and components to minimize area requirements and maximize efficiencies. Appropriately buffer and screen these and other mechanical systems and equipment.
7. New building projects should preserve open space and protect natural habitat.
8. Demolition of buildings should be done to ensure that the site is restored to a buildable condition.
9. Conform to existing topography to the greatest extent possible and use slopes to increase site and building efficiencies. Design sites to minimize irrigation and impacts to stormwater runoff.
10. The finished floor elevation of all new buildings must be a minimum of 20'0" msl. No fill shall be placed below elevation 16' 0" msl.
11. Carefully study new project sites to identify the character of adjacent buildings, streets, landscaping, and site design elements. Reinforce the existing character in new site design.
12. Consider relationships to adjacent facilities and district / centralized heating and cooling infrastructure and cost effectively connect building systems to harvest heat, grey water or other beneficial byproducts.
13. Minimize existing and planned obstructions from landscaping, structures, topography, and adjacent developments to preserve solar access and natural ventilation.
14. Purposefully integrate service access, receiving and storage areas to eliminate the need for visual screening.
15. Appropriately connect to the base network of streets, sidewalks and trails using drive aisles, parking areas, walkways, paths, and bicycle routes addressing both vehicles and pedestrians.

- 16. Applicably coordinate heat island mitigation in paving and roof designs when implementing an integrated approach to stormwater management.
- 17. Landscape using, preferably, existing tree and other vegetation to share sidewalks, parking lots, and other open area to reduce heat island impact.
- 18. Consider the location of "Designated Tobacco Areas."

C01.2. Building Orientation

Applicable N/A Select number of graphics / images (large: 800 px x 440 px) to insert 1

Image Tool 800 x 440

Applicable N/A Select number of graphics / images (small: 250 px x 188 px) to insert 6

Image Tool 250 x 188

DRIVING FACTORS

- | | | | |
|--|--|--|---|
| • Optimal solar orientation of the building. | • Maximize the daylight & desirable views. | • Meet the required AT/FP standoff distance | • Create a unified campus |
| • Main entrance from Pepperrell street. | • Saving existing vegetation and trees | • Separation between staff/public/materials entrance | • Outdoor healing environment |
| • Addressing the orientation of the future ACC | • Visibility of the new facility from main roads | • Required parking spaces for public and staff | • Implementation of landscape zones A, B, C & D |

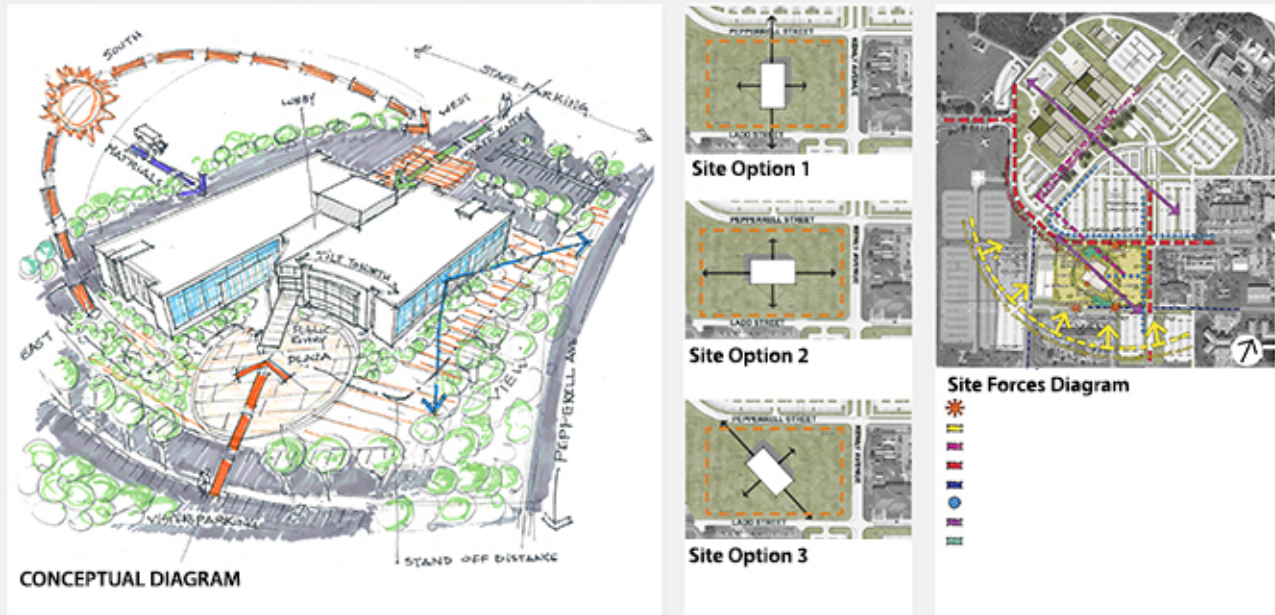

Conceptual Site Analysis and Site Design Diagram

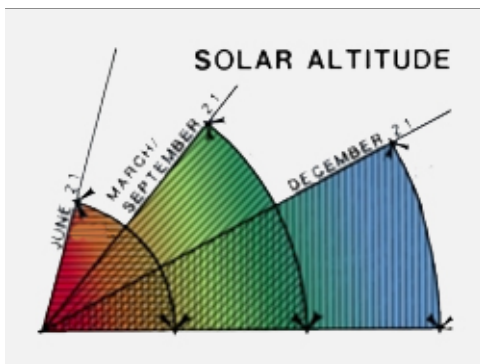

Local Solar Data

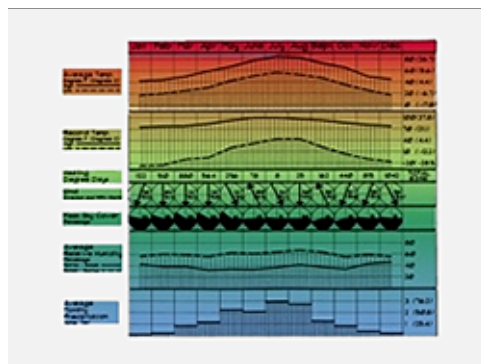

Local Climate Data

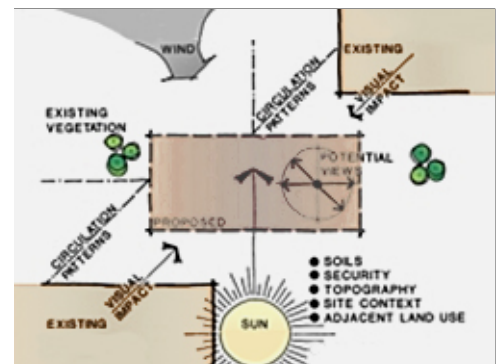

Site Data

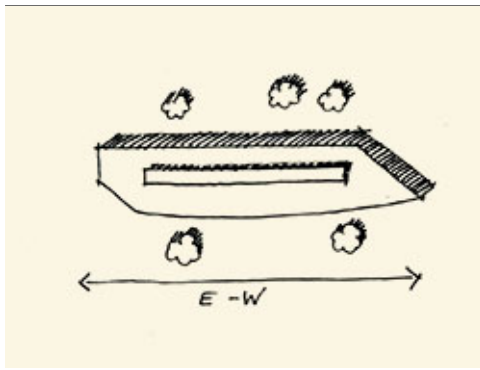

East-West Axis

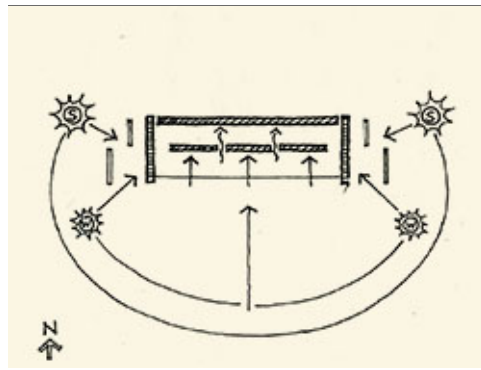

Optimum Solar Control

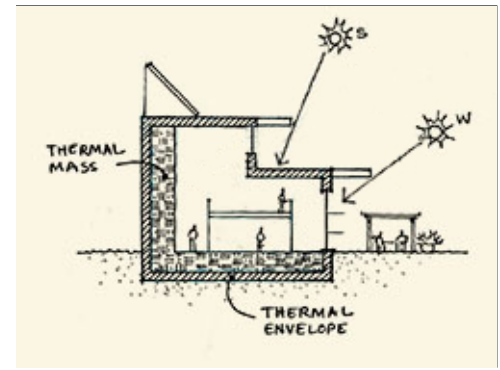

Maximized Shading

1. Ensure the site will accommodate optimum requirements for building orientation, which is with the long axis parallel to the east/west direction for rectilinear CONUS buildings.
2. Meet Installation Facilities Standards (IFS) requirements for the locations of the building's passive and renewable-energy systems --including geothermal and solar systems --and exterior shading systems.
3. Locate the building(s) and permitted ancillary structures to promote solar gain, solar shading, natural ventilation, rainwater harvesting, wind buffering and other beneficial passive systems. Consider natural ventilation during the design of HVAC systems.
4. Consider relationships to adjacent sites and their facilities and infrastructure, and cost effectively integrate building systems to harvest heat, grey water or other beneficial byproducts.
5. Consider the "public side" of the building, its views and the location of the main entrance.

C02. UTILITIES

Comply with AF Corporate Standards for Site Development:

<http://afcs.wbdg.org/site-development/index.html>

Comply with AF Corporate Standards for Utilities:

<http://afcs.wbdg.org/site-development/utilities/index.html>

C02.1. Utility Components

Applicable N/A Large graphics do not apply

Applicable N/A Small graphics do not apply

1. Provide all on-site utility service lines below grade for Facility Group 1; when mounting elements (such as utility cabinets, communications equipment and water valves) above grade is unavoidable, paint these consistently and provide visual screening following Installation Facilities Standards (IFS).
2. Provide installation of utility infrastructure to support near term and future electric vehicle charging stations.
3. Define all service entry points into the building and route distribution below grade into an interior space within the facility; exposed conduits, cables and wires on exterior walls are not permitted for Facility Group 1.
4. Include consideration of appropriate placement of meters in support of Automated Revenue Management Services (ARMS).

- Limit exterior mechanical distribution systems such as exterior steam, chilled water, and hot water distribution to Group 3 facilities; when required for Group 1 and 2 facilities integrate with the architecture and provide visual screens following IFS.
- Direct roof drainage to underground collection when feasible or provide splash blocks / paved channels to intercept roof drainage at grade.

C03. PARKING AREAS

Comply with AF Corporate Standards for Site Development:

<http://afcs.wbdg.org/site-development/index.html>

Comply with AF Corporate Standards for Parking Areas:

<http://afcs.wbdg.org/site-development/parking-areas/index.html>

C03.1. Configurations and Design

Applicable N/A Large graphics do not apply

Applicable N/A Select number of graphics / images (small: 250 px x 188 px) to insert 3

Image Tool 250 x 188

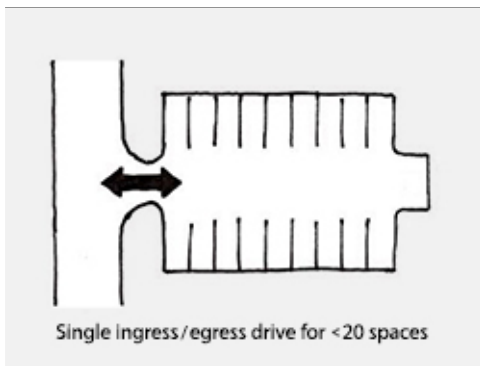

Small Lot Configuration

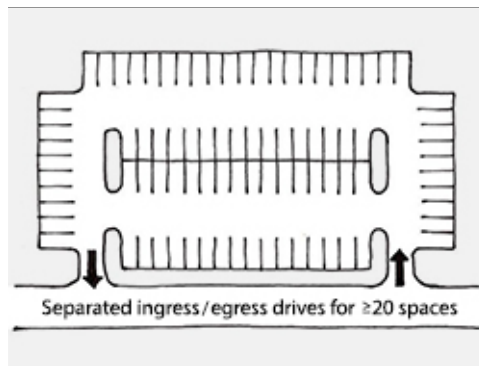

Large Lot Configuration

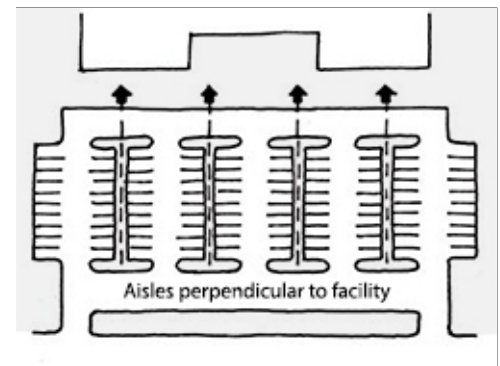

Facility Group 1 Configuration

- Evaluate adjacent sites and cost-effectively consolidate parking areas to maximize efficient use; ensure that all areas meet accessibility guidelines.
- Generally envision on-site parking as a series of small connected singular areas selectively placed around the facility served, rather than a single large area; buffer parking areas from the facility main entrance with a transition space and provide drop-offs to decrease close-in parking. Comply with IFS standards while meeting ATRP requirements.
- Integrate at-grade and raised-profile curbing, permeable paved areas, and parking islands with the stormwater system and direct stormwater to bioswales and rain gardens as source water for regionally appropriate native vegetation.
- Define pedestrian access with approved hardscape and provide shading along the primary path from the parking area to the main entrance of the building.
- Coordinate suitable landscape or barriers integrated with walls and fences to ensure adequate force protection.
- Accessible parking spaces shall be marked according to UFC 3-120-01 and its references in ABAAS and the MUTCD.
- Consider locations and requirements of near term and future electric vehicle charging stations.
- Designate preferred parking spaces for electric vehicles and carpools near the main entrance.
- Consider cost-effectively integrating solar photovoltaic arrays into covered parking structures.

10. Reserved parking is discouraged except for Facility Group 1.
11. On-street parking is discouraged except in multi-use areas. When used, provide approved on-street parking configurations following UFC 3-201-01.
12. Where cost effective utilize pavers in parking lots to encourage infiltration of storm water.
13. Parking lots should be located to maximize shared parking with nearby facilities.
14. Parking lots that promote cross traffic between parallel streets should be avoided.
15. Access and service drives should accommodate the largest vehicle serving the facility.
16. Concrete can be used for small parking lots.

C03.1.1. Paving and Striping

Applicable N/A Large graphics do not apply

Applicable N/A Small graphics do not apply

Facility Group 1 paving materials shall be as follows.

Primary: Asphaltic concrete

Secondary: Concrete

Accent: Permeable Pavers/ Concrete Edging

Facility Group 2 paving materials shall be as follows.

Primary: Asphaltic Concrete

Secondary: Concrete

Accent: Permeable Pavers/ Concrete Edging

Facility Group 3 paving materials shall be as follows.

Primary: Concrete where operationally required

Secondary: Asphaltic Concrete

Accent: N/A

Facility Group 4 paving materials shall be as follows.

Primary: Asphaltic Concrete

Secondary: N/A

Accent: N/A

1. All new parking lots in Groups 1 and 2 shall be constructed of asphaltic paving.
2. Porous paving may be considered on a case by case basis.
3. Cost-effectively provide light-colored concrete to reduce heat island effect; otherwise install asphaltic concrete paving. Dirt, gravel, and grass lots are not allowed.
4. Where cost-effective, use pavers.
5. When porous paving or pavers are used, using parking blocks around the lot edge instead of concrete edging.
6. Use consistent striping, angles and stall sizes in all parking areas.
7. All parking shall be marked with white stripes of paint or applied vinyl coatings. Red or yellow markings shall only be used for safety purposes and must be kept to a minimum. All lines shall be four inches (4") wide.
8. Parking and crosswalk striping should be meet base standards or the Military Traffic Management Command Transportation Agency guidance (MTMC).

C03.1.2. Curbing

Applicable N/A Large graphics do not apply

Applicable N/A Select number of graphics / images (small: 250 px x 188 px) to insert 3

Image Tool 250 x 188

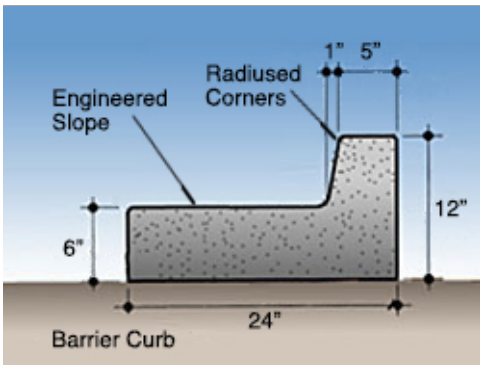

"Barrier" Curb

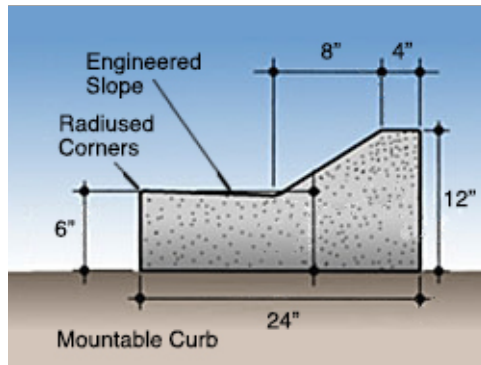

"Mountable" Curb

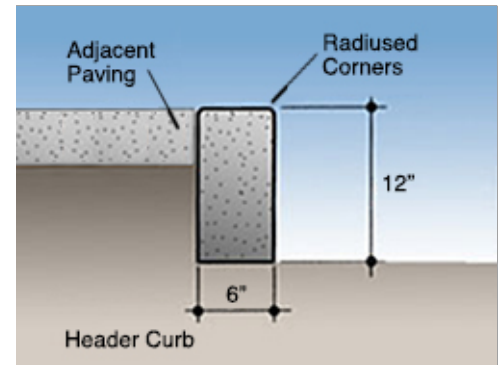

Header Curb

Facility Group 1 curbing / edging materials shall be as follows.

Primary: Concrete

Secondary: N/A

Accent: N/A

Facility Group 3 curbing / edging materials shall be as follows.

Primary: Concrete

Secondary: N/A

Accent: N/A

Facility Group 2 curbing / edging materials shall be as follows.

Primary: Concrete

Secondary: N/A

Accent: N/A

Facility Group 4 curbing / edging materials shall be as follows.

Primary: Concrete

Secondary: N/A

Accent: N/A

1. Define all parking lots with either raised profile or at-grade curbing to promote drainage and protect paving edges. All raised curbs shall be the rolled (mountable) type.
2. Integrate curbing to direct stormwater to bioswales and rain gardens as source water for regionally appropriate native vegetation.
3. Wheel stops are not permitted except at locations where car bumpers could contact adjacent items such as poles, signs or pedestrians.
4. Curbing should be continuous where possible and used as wheel stops.
5. When porous pavement is used, parking blocks may be used to allow water to drain during excessive rain fall events.

C03.1.3. Internal Islands and Medians

Applicable N/A Large graphics do not apply

Applicable N/A Select number of graphics / images (small: 250 px x 188 px) to insert 3

Image Tool 250 x 188



Medical Center Parking



Medical Center Parking



Medical Center Parking

1. Install landscape islands and medians as visual breaks, to reduce heat island effects and to accommodate bioswales and rain gardens. Coordinate suitable landscape or barriers integrated with walls and fences to ensure adequate force protection.
2. When lighting is necessary, contain fixture bases within medians or internal landscape islands.
3. Locate lighting poles in center or side island at least 3 feet from the face of the curb and this location should be coordinated with the landscape plan.
4. Perimeter screen plantings shall be encouraged to minimize the visual impact of the parking area.
5. Avoid planting shrubs in the islands. Trees are acceptable.

C03.2. Parking Structures

Applicable N/A Large graphics do not apply

Applicable N/A Small graphics do not apply

1. Parking structures are encouraged in land-constrained locations when economically feasible.
2. Consider near term and future electric vehicle charging stations and renewable energy generation development during the analysis and design.
3. Consider opportunities for integrating parking structures into multi-use developments with pedestrian-oriented uses located on the ground floor and parking on upper levels; ensure AFTP guidelines are fully addressed.

C03.3. Connectivity

Applicable N/A Large graphics do not apply

Applicable N/A Small graphics do not apply

1. Refer to the Installation Development Plan (IDP) for locations of transit stops and pedestrian and cycling networks; provide appropriately sized sidewalks and bike paths to connect facilities and users to these networks.

2. Provide amenities such as rain and shade shelters, trees, and benches to encourage and facilitate use of public transportation.
3. Evaluate the IDP for the current and planned network of roads and optimally develop vehicular access to and from the site.

C04. STORMWATER MANAGEMENT

Comply with AF Corporate Standards for Site Development:

<http://afcs.wbdg.org/site-development/index.html>

Comply with AF Corporate Standards for Stormwater Management:

<http://afcs.wbdg.org/site-development/stormwater-management/index.html>

C04.1. Stormwater Requirements

Applicable N/A Large graphics do not apply

Applicable N/A Small graphics do not apply

1. Design all stormwater systems including retention ponds, detention areas, channels, etc. as on-site amenities that are consistent with natural systems and drainage patterns, that help sustain the base landscape with beneficial functionality and that provide aesthetic appeal; coordinate with the base Stormwater Management Plan.
2. Incorporate bioswales into the design of all roadway, parking and facility roof systems to enhance water quality and support the overall stormwater system.
3. Permeable paving may be used in areas that are not subjected to severe freeze-thaw cycles.
4. Provide rainwater harvesting and storage that is attached to the building's roof drain systems to support grey water irrigation; consider freeze protection for winter months.
5. When underground drainage systems are required establish a maintenance program to include removal of sediments and debris; inspect joints seasonally for alignment to prevent leakage and the development of voids and surface failures.
6. Cost-effectively integrate stormwater systems with ATRP measures.
7. Mississippi Department of Environmental Quality (MDEQ) requires a Storm Water Pollution Prevention Plan (SWPPP) as part of the Storm Water General Permit for large construction projects (5 acres or greater) and small construction projects (greater than 1 acres, but less than 5 acres). The contractor should provide the Small Construction Notice of Intent (SCNOI) and Large Construction Notice of Intent (LCNOI), SWPPP and permit to KBOS/CEV prior to land disturbance.
8. For projects disturbing between 20,000 square feet and one acre, a contractor should prepare a Storm Water Pollution Prevention Plan (SWPPP) for approval by KBOS/CEV before ground disturbance begins.

C05. SIDEWALKS, BIKEWAYS AND TRAILS

Comply with AF Corporate Standards for Site Development:

<http://afcs.wbdg.org/site-development/index.html>

Comply with AF Corporate Standards for Sidewalks, Bikeways and Trails:

<http://afcs.wbdg.org/site-development/sidewalks-bikeways-trails/index.html>

C05.1. Circulation and Paving

Applicable N/A Large graphics do not apply

Applicable N/A Select number of graphics / images (small: 250 px x 188 px) to insert 6

Image Tool 250 x 188



Troopwalk at Training Triangle



Troop Walk at Cody Hall



Category 1 Sidewalk



Category 2 Sidewalk



Category 4 Sidewalk



I-81 Track

Facility Group 1 sidewalks, plazas, and courtyards paving materials shall be as follows.

Primary: Pervious Pavers

Secondary: Concrete Edging

Accent: N/A

Facility Group 2 sidewalks, plazas, and courtyards paving materials shall be as follows.

Primary: Pervious Pavers

Secondary: Concrete Edging

Accent: N/A

Facility Group 3 sidewalks, plazas, and courtyards paving materials shall be as follows.

Primary: Permeable concrete

Secondary: N/A

Accent: N/A

Facility Group 4 sidewalks, plazas, and courtyards paving materials shall be as follows.

Primary: Permeable concrete

Secondary: N/A

Accent: N/A

- Maintain efficient geometry and accessibility to connect building entrances to adjacent parking areas and activity areas and to the base transportation system following ATRP. Efficiently use materials to optimize life-cycle costs and to minimize maintenance.

2. Generally conform horizontal layouts of sidewalks to the geometric configuration of adjacent buildings, streets, parking lots, and other adjacent related site amenities. Occasional meanders and/or jogs may be included to capture views, to coordinate with landscaping or accommodate site constraints.
3. Walks in parking areas shall provide a direct path using "safe islands" and "peninsulas" to encourage safety. Walks parallel to streets shall follow streetscape guidelines. Clearly mark pedestrian crossings at vehicular routes.
4. Mitigate heat island by providing high-albedo, shaded sidewalks. Pervious pavers shall be used on all sidewalks, plazas and courtyards in Facility Groups 1 and 2; use pervious concrete in Groups 3 and 4. The designer shall incorporate appropriate expansion and construction joints.
5. Only experienced contractors will install pervious pavements.
6. Consider an integrated approach that could include stormwater management (permeable surfaces) and complement the design of the storm drainage system when appropriate.
7. Pedestrian paths should be at least 5' in width to allow for comfortable side-by-side walking.
8. Sidewalks leading to a building main entrance and at the interior of parking lots shall be a minimum width of 6'. Walks greater than 10' wide may be used at high-density pedestrian areas where volumes of traffic justify added material.
9. Where cars park adjacent and head-in to the sidewalk and wheel stops are not used, such perimeter walks shall be increased to a minimum width of 8' to accommodate overhangs of the parked vehicles.
10. All sidewalks shall have positive drainage to prevent ponding of water with slopes ranging from 2.1% to 4.2%. Walks with a slope greater than 4.2% shall be designed as ramps following accessibility guidelines. All walks shall have a minimum cross slope of 2.1%.
11. Pavers shall conform to the existing range of colors. Pavers used on walks shall typically be 4" X 2" in size, but preferable to match existing pavers.
12. Sidewalks should be separated from vehicular traffic whenever possible.
13. Connect to the bicycle circulation system and provide bicycle parking with a suitable means for securing bicycles following IFS. Consider changing/shower facilities for use by cyclists.
14. New walkways should be laid out to accommodate existing mature street trees.
15. If the tree must be removed, approval must be received from the Installation Commander and replaced as directed by Keesler Policy.
 - a. Preservation of trees involves protecting as much as the root system as possible, out to the drip line. The ideal is to leave the root system entirely unpaved.
 - b. If the root system must be paved over, the existing grades around the tree should be disturbed as little as possible and drain openings should be provided in the pavement to allow air to circulate in the root zone.
 - c. If the root zone is damaged, the crown of the tree should be pruned to reduce the demand for nutrients and water.
16. Troopwalks should be ten feet to twelve feet wide.
17. Materials on the troopwalks should match the adjacent facilities. Colors and detailing should be repeated with special attention to walk intersections.
18. Vehicular access to troopwalks should be prohibited and controlled through the use of bollards. Consideration for emergency vehicles can be made if the troopwalk is used to support that function, both in locations and in design.
19. Refer to the Installation Development Plan for future trails, bicycle paths, and sidewalks.

C05.1.1. Ramps and Stairs

Applicable N/A Large graphics do not apply

Applicable N/A Small graphics do not apply

1. Use ramps instead of stairs for sidewalks, bikeways and trails and at all buildings where possible. Where steps are unavoidable, follow UFC 1-200-01 and its references to the International Building Code.

C05.1.2. Lighting

Applicable N/A Large graphics do not apply

Applicable N/A Small graphics do not apply

1. Provide lighting for all stairs and landings where traffic warrants.
2. Refer to the Lighting section for path lighting along sidewalks, bikeways and trails.
3. Provide adequate lighting at any point where there is a change in grade requiring steps, near ramps, at motorcycle parking and near main entrances to buildings.
4. Streetscape lighting should be standardized throughout the base to one or two types and styles. Consider both compatibility and durability.
5. Streetscape lighting should be mounted on individual poles and not on exterior facilities.

C06. LANDSCAPE

Comply with AF Corporate Standards for Site Development:

<http://afcs.wbdg.org/site-development/index.html>

Comply with AF Corporate Standards for Landscape:

<http://afcs.wbdg.org/site-development/landscape/index.html>

C06.1. Climate-based Materials

Applicable N/A Select number of graphics / images (large: 800 px x 440 px) to insert 1

Image Tool 800 x 440

Applicable N/A Small graphics do not apply



Trees for Shading

1. Use only native, naturally occurring, drought tolerant indigenous plant species (including grasses) appropriate for the locale to promote energy efficiency and water conservation, preserve drainage patterns, inhibit erosion, improve air quality, lower maintenance, and add beauty.
2. Follow details and specifications of the American Standard for Nursery Stock, current edition.

C06.1.1. Landscaping Design Concept

☐ Applicable ○ N/A Select number of graphics / images (large: 800 px x 440 px) to insert 1

Image Tool 800 x 440

☐ Applicable ● N/A Small graphics do not apply

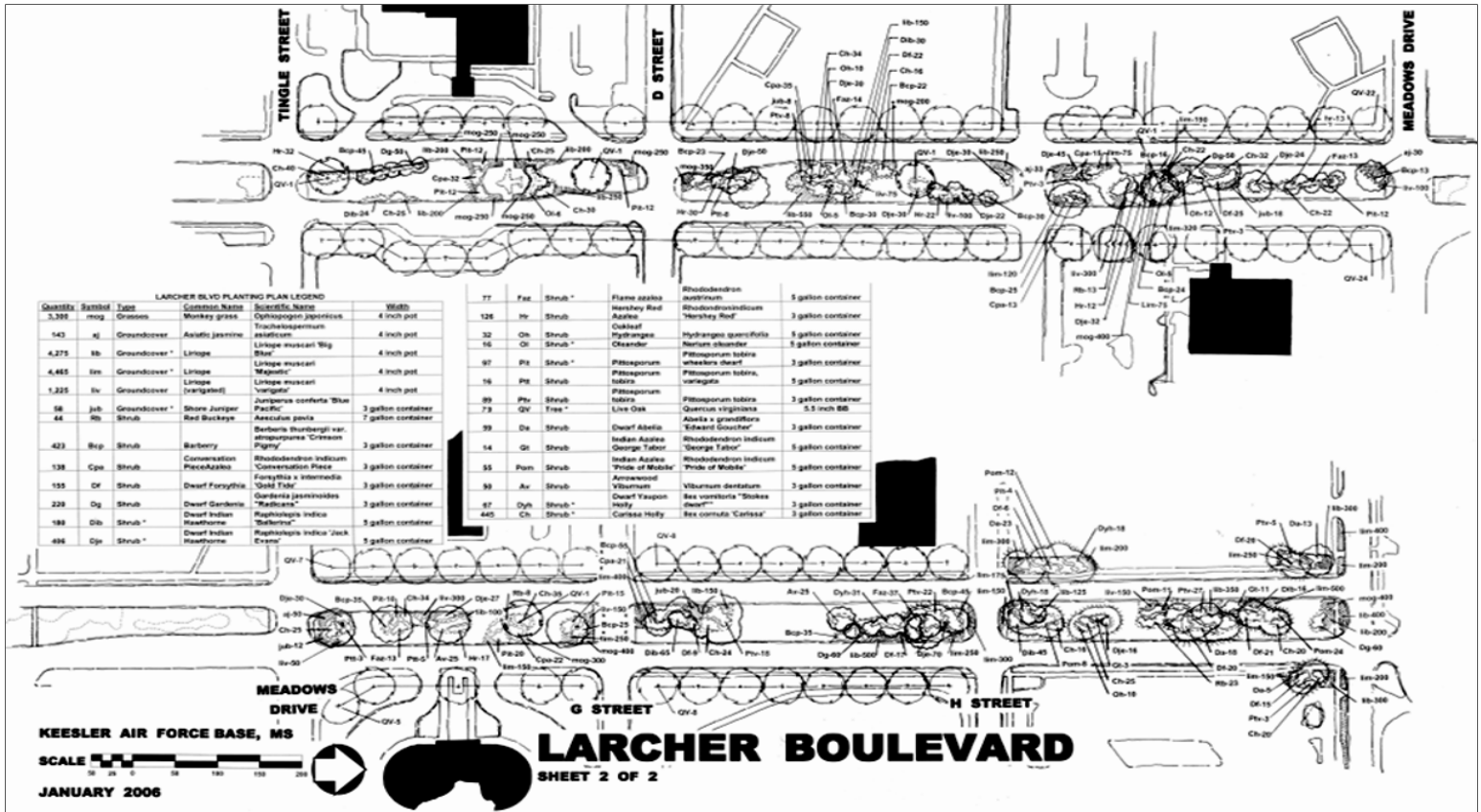

Typical Landscape Site Plan with Keyed Plant List

1. Develop, maintain and implement a climate-based plant list with landscape features using a regionally appropriate palette of materials to promote energy efficiency, preserve drainage patterns, inhibit erosion, improve air quality, lower maintenance and add beauty. Follow UFC 3-201-02 Landscape Architecture. Keesler AFB specific plant list is included in the Appendix.
2. Landscaping is required for all newly developed sites and facilities; preserve existing native landscape where possible and avoid overplanting.
3. Concentrate landscaping in Facility Group 1 and along major thoroughfares and integrate these landscaped areas into the base's stormwater management plan. Refer to the Streetscape Envelope Standards in this IFS.
4. All Facility Group 1 and 4 sites shall be landscaped at their entire perimeter; limit formal planting arrangements to formal spaces typically associated with Group 1. Landscape public spaces near the main entrances of Group 1 facilities.
5. Facility Group 2 and 3 sites may have a native undisturbed landscape except at the main entrances of Group 2, which should be newly landscaped.
6. Facility plantings shall follow the Installation Facilities Standards (IFS) plant list, which is based on the specific microclimates created by the adjacent building; shadow areas, protected areas, zones adjacent to thermal mass, and availability of rainwater and/or grey water.
7. Provide open spaces as transitions between developed and native areas that promote quality of life and provide visual relief and allow walkable connections to the transportation system.

8. Return suitable areas to a natural state to minimize and, whenever possible, eliminate ground maintenance requirements; expand prairie areas where appropriate with native plants to eliminate mowing and maintenance requirements.
9. In tree clusters replace grass with naturalized shrub beds and leaf litter mulch to eliminate mowing requirements.
10. Use plantings in open spaces to reinforce the space as a visual asset.
11. Consider landscape windbreaks when suitable for the local climate.
12. Integrate security requirements into the landscape design. Coordinate the heights of trees and shrubs and note restrictions for plantings following UFC 4-010-01.
13. Berms may be used as an integral part of the overall landscape strategy for screening, security and/or visual interest.

C06.1.2. Xeriscape Design Principles

Applicable N/A Large graphics do not apply

Applicable N/A Small graphics do not apply

1. Apply xeriscape principles following UFC 3-201-02, Appendix B, and Air Force Corporate Facilities Standards.
2. Facility plantings are encouraged to use native plant species and to consider specific microclimates created by the adjacent building: shadow areas, protected areas, zones adjacent to thermal mass, and availability of rainwater and/or grey water.

C06.1.3. Minimizing Water Requirements

Applicable N/A Large graphics do not apply

Applicable N/A Small graphics do not apply

1. Reasonably reduce demand on potable water while seeking opportunities to increase alternative water sources for irrigation. Reduce or eliminate the use of potable/domestic water for purposes of landscape architecture maintenance, consistent with existing legal or contractual obligations, and prohibit potable-water irrigation in new construction beyond establishment following current DoD and Air Force policy

C06.1.4. Plant Material Selection

Applicable N/A Large graphics do not apply

Applicable N/A Select number of graphics / images (small: 250 px x 188 px) to insert 3

Image Tool 250 x 188



Ornamental Planting



Trees, Shrubs and Grasses



Trees for Shading

1. Use only native, naturally occurring plant materials including grasses or turf suited for the local climatic conditions in the landscape design; potable-water irrigation systems are discouraged beyond the establishment period.
2. New facilities are encouraged to use native plant species as indicated on the Base Plant list available from the BCE.
3. Trees should be the focus of landscape plantings and, where possible, should be a mix of deciduous and evergreen species for variety; provide tree grates when appropriate and use tree guards on smaller trees.
4. Ground covers are only recommended when minimal maintenance is required.
5. Turf areas should be limited to those that can be sustained by natural rainfall or grey water (non-potable) irrigation systems; turf may be defined by at-grade concrete mow strips to lessen maintenance.
6. Analyze soils and provide organic amendments as needed to improve plant growth and conserve water.

C06.1.5. Water Budgeting (Hydrozones)

Applicable N/A Large graphics do not apply

Applicable N/A Small graphics do not apply

1. Comply with DoD and Air Force policy on potable-water irrigation systems.
2. Provide irrigation systems in new construction to establish plant materials following "Water for Landscaping" in UFC 1-200-02. Note the climate zone and annual rainfall for the locale.
3. New buildings shall cost-effectively integrate a grey-water reclamation system following UFC 1-200-02, which provides source water for an automatic drip irrigation system; connect adaptive plantings adjacent to facilities to a grey-water irrigation system when available and discontinue the use of potable water for irrigation after the establishment period.
4. Provide irrigation design following UFC 3-201-02. Install drip irrigation products and components following UFGS Section 32 84 24 Irrigation Sprinkler Systems. Match the color of valve box lids to the adjacent ground treatment (i.e. green at turf & native seed areas, brown at wood mulch & rock areas).
5. Life cycle cost-effectively equip irrigation systems to sense soil moisture, rainfall and wind to minimize unnecessary watering; incorporate drip irrigation systems as the primary source.

C06.1.6. Base Entrance Landscaping

Applicable N/A Large graphics do not apply

Applicable N/A Select number of graphics / images (small: 250 px x 188 px) to insert 3

Image Tool 250 x 188



Drought Tolerant Shrubs



Flowering Shrubs as a Focal Point



Flowering Perennials at Avenue of Flags

1. At the main gate, reinforce a sense of arrival through a well-designed concentration of landscape elements consistent in visual quality with Facility Group 1.
2. Ensure landscaping has seasonal features with spring and fall color and a combination of evergreen and deciduous trees and shrubs for winter interest.
3. Integrate base signs and street and pedestrian lighting whenever feasible.
4. Installation requirements for Meadows Gate, Pass Road Gate, and White Avenue Gate are included within the Appendix. Landscaping design for Division Street Gate?

C06.1.7. Streetscape Landscaping

Applicable N/A Select number of graphics / images (large: 800 px x 440 px) to insert 1

Image Tool 800 x 440

Applicable N/A Small graphics do not apply

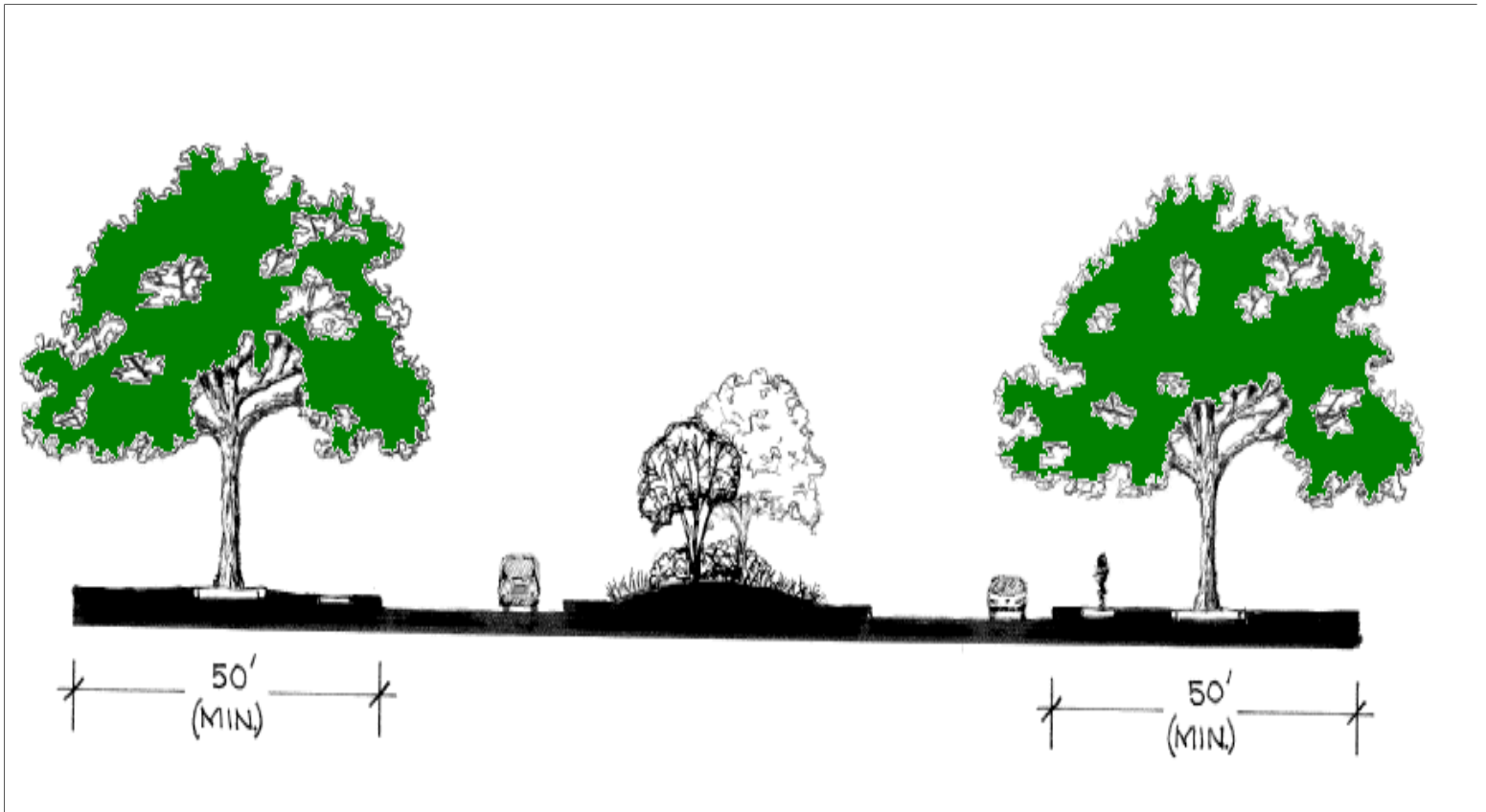

Larcher Boulevard Cross Section

1. Provide landscape designs with plant materials appropriately representing the level of quality of the adjacent Facility Group number. Refer to the Installation Elements section.
2. Select a variety of regionally appropriate streetscape plantings and grading to create a visual interest.
3. Larcher Boulevard and Meadows Street are focal points. Specific landscaping schematics for these areas are included in the appendix.

C06.1.8. Pedestrian Circulation Landscaping

Applicable N/A Large graphics do not apply

Applicable N/A Small graphics do not apply

1. Define walkways with landscaping where appropriate.
2. Provide rest areas along the pedestrian circulation network with human-scaled deciduous shade trees. Supplement tree plantings with finely textured shrubs when appropriate for the climate.
3. Provide wind breaks where required.

- If possible, new walkways should be laid out to accommodate existing mature street trees. Preservation of trees involves the protection of the root zone out to the drip line. The ideal situation is to leave the root zone entirely unpaved. If the root zone must be paved over, the existing grades around the tree should be disturbed as little as possible and drain opening should be provided in the paved to allow air to circulate to the root zone. If the root zone is damaged, the crown of the tree should be pruned to reduce the demand for nutrients and water.

C06.1.9. Parking Lot Landscaping

Applicable N/A Large graphics do not apply

Applicable N/A Select number of graphics / images (small: 250 px x 188 px) to insert 2

Image Tool 250 x 188



Trees Defining Space



Trees Providing Shade

- Integrate appropriate landscaping elements into parking areas to visually soften the appearance at a minimum rate approved by the BCE.
- Avoid trees that drop sap, fruit, or seeds, and use long-lived species; keep trees trimmed, removing dead and dying trees or branches.
- Provide planting in islands within parking lots for shade and appeal following IFS and Keesler AFB Installation Stormwater Management Plan. Islands must be a minimum of eight (8) feet wide if the median is to contain trees.
- Rain garden islands shall be landscaped to receive rainwater runoff from adjacent impervious parking areas to be absorbed into the ground/planting bed. Native plants and groundcovers are recommended within the rain garden areas, which can survive without supplemental irrigation once established.
- Utilize native species and species well adapted to the climate as listed in the Keesler AFB recommended species.

C06.1.10. Screen/Accent Landscaping

Applicable N/A Large graphics do not apply

Applicable N/A Small graphics do not apply

- Provide complimentary accent landscaping at monuments and static displays.
- At Facility Group 1, provide landscaping adjacent to all freestanding signs without distracting from the written communication.
- Provide landscape screening of utility elements adjacent to Facility Group 1.
- Providing landscaping as visual screening is preferred to the construction of walls and fences; berming and mounding may supplement landscape screening.

5. Utilize native species and species well adapted to the climate as listed in the Keesler AFB recommended species.

C06.1.11. Other

Applicable N/A Large graphics do not apply

Applicable N/A Select number of graphics / images (small: 250 px x 188 px) to insert 2

Image Tool 250 x 188



Airman's Oak



Tree City USA

1. Keesler's urban forest is an important part of the history and identity of the base. Care should be given to avoid the siting buildings under canopies or the removal of healthy, large specimen trees such as the Live Oaks, rare Red and White Oaks and Magnolias.
 - a. Approval to remove specimen trees must be received from the Installation Commander.
 - b. Installation or Air Force Policy requires that the trees must be replaced based upon the formula defined within the Installation or Air Force Policy Contact KBOS/CV for the current policy.
 - c. Specimen trees are defined as an example, which characterizes a species or type for display.
2. No trees or landscaping can be replaced or planted within the Clear Zone or lateral clearance of the runway (with the exception of the Marina Park). Inclusion of trees within the landscaping plans for building within the transitional surface area, should take into account the maximum height of the tree and at maximum height this trees should not exceed the allowable height at that location.

C07. SITE FURNISHINGS

Comply with AF Corporate Standards for Site Development:

<http://afcs.wbdg.org/site-development/index.html>

Comply with AF Corporate Standards for Site Furnishings:

<http://afcs.wbdg.org/site-development/site-furnishings/index.html>

C07.1. Furnishings and Elements

Applicable N/A Large graphics do not apply

Applicable N/A Small graphics do not apply

1. Provide a coordinated consistent inventory of site furnishings to positively contribute to the visual environment, image, and identity of the base; ensure durability, low maintenance, reduced visual clutter, and compatibility with the adjacent architecture.
2. Remove poorly located or redundant litter / ash receptacles, newspaper and bicycle racks, telephone booths, vending machines, walls and fences to reduce visual clutter and to lessen the requirements for maintenance.

3. Group 1, 2, 3 and 4 site furnishing shall be precast. Slatted metal designs may be used in pavilions and shaded areas. Generally match the site furniture of adjacent facilities and the facility district.
4. Install needed outdoor seating (benches and low walls) in public gathering spaces near main and secondary building entrances. Low walls shall match facility architecture.
5. Benches in Groups 1, 2 and 3 shall be precast. Slatted metal designs may be used in pavilions and shaded areas. Provide metal benches in Group 4 and parks.
6. Integrate functional bicycle racks with the design of the building's main entrance grounds in Facility Groups 1 and 2 while meeting AT/FP requirements.
7. Limit the use of bollards, but when necessary for force protection use dark bronze or silver metal bollards in Groups 1 and 2; steel bollards in Group 3; dark bronze bollards in Group 4, parks and trails. Illuminated bollards may be used as approved on a case basis. Special bollards are permitted at the Marina.
8. Locate architecturally coordinated containers for recycling, litter, ash, vending, etc., to minimize visual clutter and not visible from the building's main entrance. Minimize the use of freestanding planters.
9. Generally limit picnic tables, barbeque grills and drinking fountains to lodging, dormitories, housing areas, parks and recreation areas following IFS.
10. The Installation Flagpole location shall comply with the guidance for the display of flags in AFI 34-1201. Each Air Force installation is authorized to fly one United States Flag, normally in front of the installation headquarters. Waivers for non-authorized locations must be submitted in accordance with AFI 33-360 and approved waivers (AF Form 679) must be maintained by the installation protocol office.
11. Refer to the Overview Section "Facility Hierarchy" topic of this AFCFS for guidelines regarding ancillary structures such as pavilions and shade shelters.
12. Bus shelters shall be provided only where there is a documented need and when approved on a case basis. Generally emulate the designs of adjacent shelters using metal and clear glazing.
13. Monuments and static displays shall be limited. New elements are generally discouraged unless these are fully vetted through the base's approval process and designed following IFS.
14. When visual screening is necessary, consider landscaping as the first option; screen walls are permitted only in Group 1 finished to match the adjacent building.
15. For fencing, apply the standards for "Type, Color, Finish, and Model" in the following section. Limit those with the highest visual quality to Facility Group 1 where there is sustained maintenance. Define all levels of security and visual quality.
16. Do not use chain-link fencing at Group 1, 2 or 4 facilities; Limit the use of barbed-wire outriggers on chain-link fencing at industrial sites, unless required for additional security or protection of assets.
17. Wood fencing may be used in Facility Group 4 and in recreation areas following IFS for material and finish when there is sustained periodic maintenance.
18. Provide trash dumpster enclosures for Group 1 and 2 with brick enclosures and metal gates to match adjacent facilities and for Group 3 with dark bronze metal; all gates shall be metal factory finished dark bronze.
19. Specify screen wall materials and finishes that do not require painting or maintenance beyond periodic cleaning.
20. Group 1, 2 and 3 picnic tables and seating shall be precast. Slatted or perforated metal designs may be used in pavilions and shaded areas. Group 4 and recreational areas shall have metal picnic tables and seating. Generally limit picnic tables, barbeque grills and drinking fountains to lodging, dormitories, housing areas, parks and recreation areas.
21. Limit the use of freestanding planters to areas with ongoing maintenance.

22. Provide kiosks only where there is a documented need for visual communication of posted messages. When used, match adjacent facilities in materials and detailing and consolidate kiosks with other site furnishings within 30 feet of major pedestrian paths. Limit kiosks to facility Groups 1 and 2 and parks.

23. Manufacturers listed below are only provided to establish a baseline of equivalency among all applicable manufacturers.

C07.2. Site Furnishings Products, Materials and Color

Note: Apply the below base-wide standards for Site Furnishings (products, materials and color). Then refer to the Appendix and apply any additional requirements specifically related to the Facility District in which the project is located.

C07.2.1. Barbeque Grills

Applicable N/A Number of base standards 2

Image Tool 250 x 188



Type: **Charcoal**

Applies to: Group 1 Group 2 Group 3 Group 4 Other

Mfr: Most Dependable Fountains, Inc.

Color: Natural stainless steel

Finish: Mill

Model #: SS BBQ Grill

Other: Concrete foundation, coordinate with Base Architect

UFGS: N/A



Type: **Natural Gas**

Applies to: Group 1 Group 2 Group 3 Group 4 Other

Mfr: BBQ Coach

Color: Natural stainless steel

Finish: Mill

Model #: 32" 4-Burner

Other: Built-in Concrete or masonry, coordinate with Base Architect

UFGS: N/A

C07.2.2. Benches

Applicable N/A

Number of base standards 4

Image Tool 250 x 188



Type: _____

Applies to: Group 1 Group 2 Group 3 Group 4 Other

Mfr: Materials, Inc. _____

Color: Weatherstone Gray _____

Finish: Standard Finish (Smooth) _____

Model #: Mesa, Rectangular design _____

Other: N/A _____

UFGS: N/A _____

Type: **Central Park** _____

Applies to: Group 1 Group 2 Group 3 Group 4 Other

Mfr: _____

Color: Brown _____

Finish: _____

Model #: _____

Other: _____

UFGS: _____





Type: **Modern Wave Bench**

Applies to: Group 1 Group 2 Group 3 Group 4 Other

Mfr:

Color: Brown

Finish: Powder Coat

Model #:

Other: For use in Training Triangle

UFGS:

Type: **Contour Bench**

Applies to: Group 1 Group 2 Group 3 Group 4 Other

Mfr:

Color: Brown and Aggregate

Finish: Metal and Aggregate

Model #:

Other: In use at Food Court/ BX/ Commissary

UFGS:



C07.2.3. Bike Racks

Applicable N/A

Number of base standards 1

Image Tool 250 x 188



Type: **Style 1**

Applies to: Group 1 Group 2 Group 3 Group 4 Other

Mfr: Brandir International Inc.

Color: Galvanized

Finish: Factory

Model #: The Ribbon Bike Rack, RB-07

Other: N/A

UFGS: N/A

C07.2.4. Bike Lockers

Applicable N/A

C07.2.5. Bollards

Applicable N/A

Number of base standards 4

Image Tool 250 x 188



Type: **Lighted Square Sloped Top**

Applies to: Group 1 Group 2 Group 3 Group 4 Other

Mfr: Kim Lighting

Color: Platinum Silver

Finish: Anodized aluminum

Model #: VSB1 Square

Other: 3000K LED Lamp, 360° downlighting

UFGS: N/A



Type: **Lighted Round Dome Top**

Applies to: Group 1 Group 2 Group 3 Group 4 Other

Mfr: Lithonia Lighting Products

Color: Dark Bronze

Finish: Anodized aluminum

Model #: KBA

Other: Flared cone, 3000K LED Lamp

UFGS: N/A

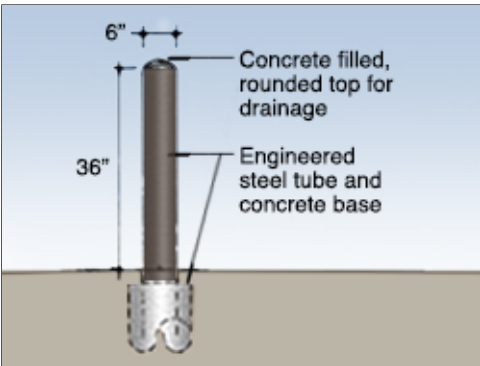

Type: **Building Protection, steel**

Applies to: Group 1 Group 2 Group 3 Group 4 Other

Mfr: (Bollard Cover) Reliance Foundry

Color: Brown cover may be field painted dark bronze

Finish: Factory

Model #: 6" Steel pipe, concrete filled, Cover: R-7173

Other: A 1" (25.4 mm) rigid conduit and box with shroud may be provided at top of bollard with a receiver/key switch application

UFGS: N/A



Type: **Marina Lighted Bollards**

Applies to: Group 1 Group 2 Group 3 Group 4 Other

Mfr: TBD

Color: White

Finish: Powder coat

Model #: Nautical theme

Other: For use only in Marina Park

UFGS: N/A

C07.2.6. Bus Shelters

Applicable N/A

Number of base standards 1

Image Tool 250 x 188

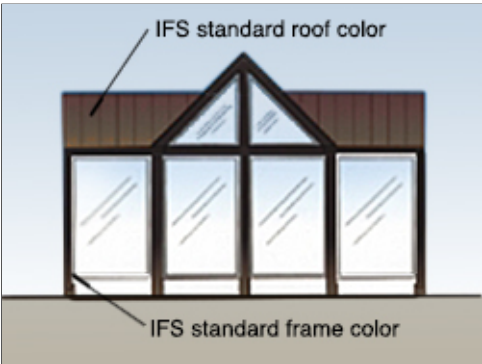

Type: **1**

Applies to: Group 1 Group 2 Group 3 Group 4 Other

Mfr: Custom

Color: Dark Bronze

Finish: Powder coated

Model #: Gabled roof

Other: Provide concrete slab and 2 pre-manufactured aluminum benches

UFGS: N/A

C07.2.7. Drinking Fountains

Applicable N/A

Number of base standards 1

Image Tool 250 x 188



Type: **Pedestal**

Applies to: Group 1 Group 2 Group 3 Group 4 Other

Mfr: Most Dependable Fountains, Inc.

Color: Natural

Finish: Stainless Steel

Model #: MDF 440 SMSS

Other: Accessible

UFGS: N/A

C07.2.8. Dumpster Enclosures / Gates

Applicable N/A

Number of base standards 1

Image Tool 250 x 188

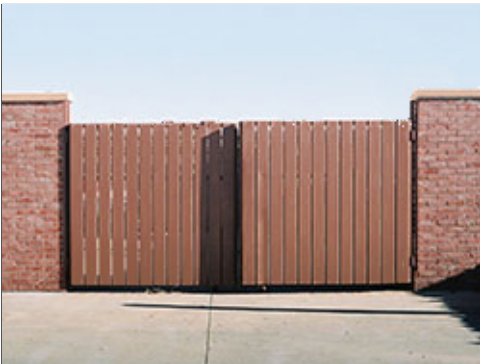

Type: **1: Brick and Steel**

Applies to: Group 1 Group 2 Group 3 Group 4 Other

Mfr: Custom

Color: Red brick blend, dark brown doors

Finish: Face brick, powder coated doors

Model #: Match adjacent building

Other: Steel gates and hardware, dark brown, dumpsters shall be painted dark brown

UFGS: Section 04 20 00 Unit Masonry

C07.2.9. Fencing

Applicable N/A

Number of base standards 7

Image Tool 250 x 188

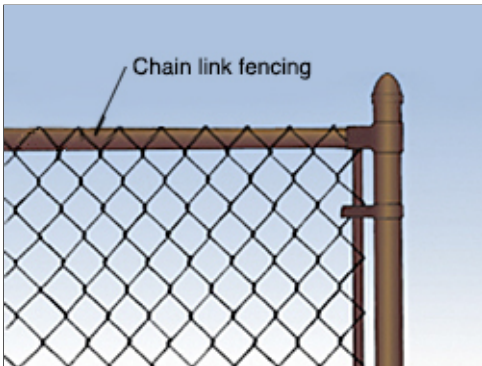

Type: **Style A Barrier: High security, low visibility**

Applies to: Group 1 Group 2 Group 3 Group 4 Other

Mfr: General Wire Co.

Color: Dark brown

Finish: PVC coating over galvanized steel

Model #: Chain link, steel posts and rails, gates and accessories

Other: N/A

UFGS: Section 32 31 13 Chain Link Fences and Gates

Type: **Style B Barrier: High security, medium visibility**

Applies to: Group 1 Group 2 Group 3 Group 4 Other

Mfr: Custom

Color: Dark brown

Finish: Powder coat

Model #: Steel grid: flat bar stock verticals, round rod horizontals

Other: Steel posts, horizontal bars, braces, and accessories, in heights, lengths, and gauges as required; Close all ends of tubing

UFGS: Section 05 50 13 Miscellaneous Metal Fabrications

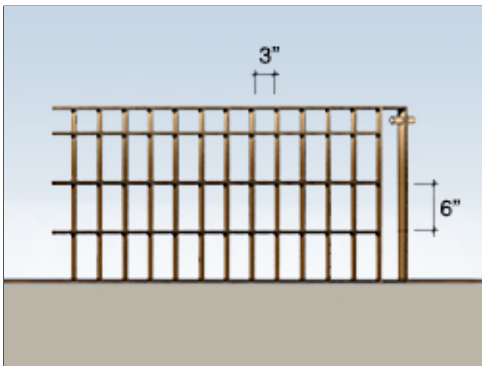

Type: **Style C Barrier: Medium security, medium visibility**

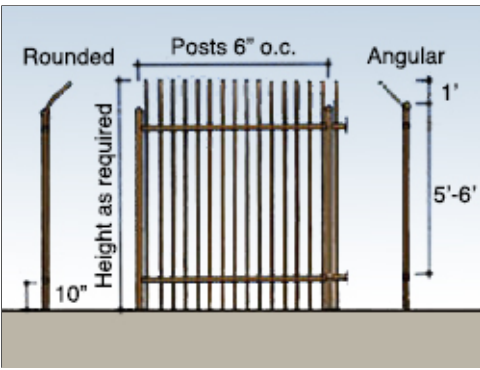

Applies to: Group 1 Group 2 Group 3 Group 4 Other

Mfr: Custom

Color: Dark Brown

Finish: Powder coat

Model #: Steel posts, rails and pickets (vertical, bent outward at top)

Other: Posts, rails, and pickets in heights, lengths and gauges as required, (see Appendix for Facility Districts requirements)

UFGS: Section 05 50 13 Miscellaneous Metal Fabrications

Type: **Style D Barrier: Low security, High visibility**

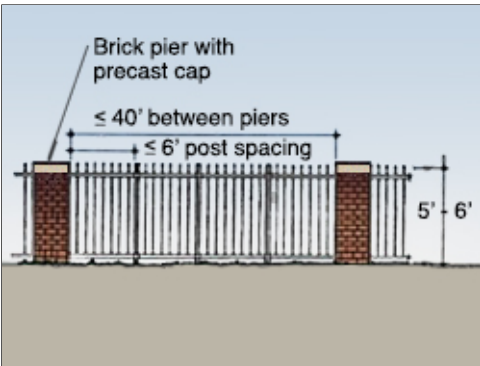

Applies to: Group 1 Group 2 Group 3 Group 4 Other

Mfr: Custom

Color: Red brick blend, dark brown fencing

Finish: Face brick, powder coated metal

Model #: Brick Piers with steel posts, rails and pickets

Other: Brick: 2'x2' (Height as required, equally spaced 12' to 40'), Steel posts: 4"x4" (equally spaced), Rails: 2"x2", Pickets: 1"x1" (6"o.c.); close all ends of tubing

UFGS: Section 04 20 00 Unit Masonry, Section 05 50 13 Misc. Metal

Type: **Style E Barrier: Low security, High visibility**

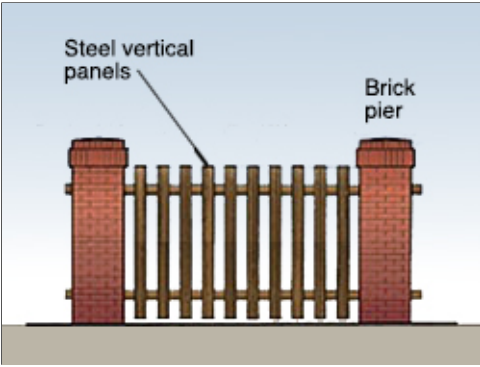

Applies to: Group 1 Group 2 Group 3 Group 4 Other

Mfr: Custom

Color: Red brick blend, dark brown fencing

Finish: Powder coated metal

Model #: Brick Piers with steel posts, rails and alternating panels

Other: Brick: 2'x2' (Height as required, equally spaced 8' to 40'), Steel posts: 4"x4" (equally spaced), Rails: 1-1/4"x1-1/2", vertical steel panels spaced alternately on each side of the rails; matching gates; close all ends

UFGS: Section 04 20 00 Unit Masonry, Section 05 50 13 Misc. Metal

Type: **Style F Barrier: Very low security, high visibility**



Applies to: Group 1 Group 2 Group 3 Group 4 Other

Mfr: Custom

Color: Integral mixed Davis Colors: dark warm gray

Finish: Factory

Model #: Post and rail

Other: Concrete 3-rail, wood-grain textured (4,000 psi at 28 days); Posts: 39" height, 8' spacing, set 30" deep below grade with footing, typical

UFGS: SECTION 03 33 00 Cast-In-Place Architectural Concrete

Type: **Style G Barrier (Alternate): Very low security, high visibility**



Applies to: Group 1 Group 2 Group 3 Group 4 Other

Mfr: James Hardie Building Products, Inc.

Color: Off white and Earth tones

Finish: Factory

Model #: Post and rail with vertical boards

Other: Posts: Height as required, 8' max. spacing; apply boards to outside face.

UFGS: Not Available (SECTION 074646 Fiber Cement Siding)

C07.2.10. Flagpoles

Applicable N/A

Number of base standards 1

Image Tool 250 x 188



Type: 1

Applies to: Group 1 Group 2 Group 3 Group 4 Other

Mfr: Eder Flag

Color: Natural aluminum

Finish: Satin Lustre

Model #: ECL30 IH, Internal Halyard

Other: 5" Butt Dia. 33' H (30' Exposed)

UFGS: N/A

C07.2.11. Lighting – Landscape / Accent

Please refer to the Lighting section.

C07.2.12. Litter and Ash Receptacles

Applicable N/A

Number of base standards 2

Image Tool 250 x 188

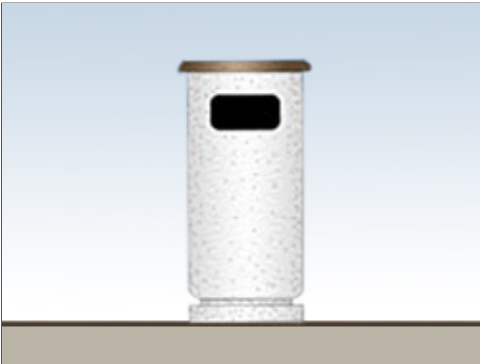

Type: **Style 1: Precast concrete**

Applies to: Group 1 Group 2 Group 3 Group 4 Other

Mfr: Materials, Inc.

Color: Weatherstone Gray

Finish: Smooth

Model #: TR-3225 Sante Fe (round or square)

Other: Rigid plastic internal liner,
http://materialsinc.com/wp-content/uploads/2014/10/TR-3225_SANTA_FE.pdf

UFGS: N/A

Type: **Style 2: Metal**

Applies to: Group 1 Group 2 Group 3 Group 4 Other

Mfr: Wabash Valley

Color: Black or as approved

Finish: Perforated Pattern

Model #: Urbanscape "E" with liner, 32 Gallon

Other: With dome top, without side door

UFGS: N/A



C07.2.13. Picnic Tables

Applicable N/A

Number of base standards 2

Image Tool 250 x 188



Type: **Precast concrete**

Applies to: Group 1 Group 2 Group 3 Group 4 Other

Mfr: Materials, Inc.

Color: Weatherstone Gray

Finish: Standard Finish (Smooth)

Model #: TS-3490 New Mexican

Other: (303) 458-9595

UFGS: N/A



Type: **Metal, vinyl coated**

Applies to: Group 1 Group 2 Group 3 Group 4 Other

Mfr: Wabash Valley

Color: Brown or as approved

Finish: Factory vinyl coated

Model #: Signature Series, 46" Square Pedestal Tables with 4 Seats

Other: Perforated Pattern, In-ground mount

UFGS: N/A

C07.2.14. Planters

Applicable N/A

Number of base standards 1

Image Tool 250 x 188

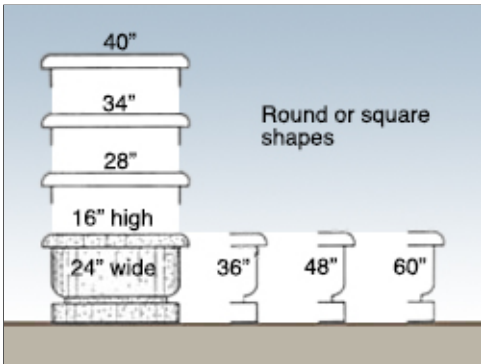

Type: **Precast concrete**

Applies to: Group 1 Group 2 Group 3 Group 4 Other

Mfr: Materials, Inc.

Color: Weatherstone Gray

Finish: Smooth

Model #: Santa Fe

Other: N/A

UFGS: N/A

C07.2.15. Play Equipment

Applicable N/A

Number of base standards 1

Image Tool 250 x 188



Type: **Steel**

Applies to: Group 1 Group 2 Group 3 Group 4 Other

Mfr: Little Tikes Commercial

Color: Varies

Finish: Powdercoated Steel

Model #: N-R-G Freestyle

Other: Coordinate with Base Architect

UFGS: N/A

C07.2.16. Screen Walls

Applicable N/A

Number of base standards 1

Image Tool 250 x 188

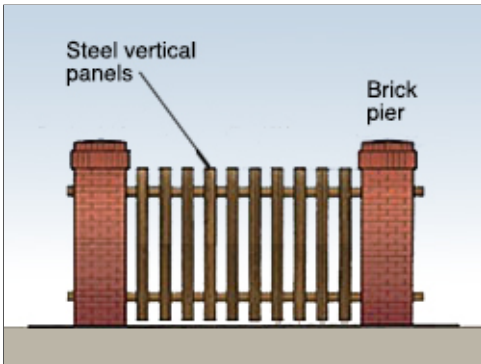

Type: **Brick / Steel**

Applies to: Group 1 Group 2 Group 3 Group 4 Other

Mfr: Custom

Color: Red brick blend, dark brown fencing

Finish: Powder coated metal

Model #: Brick Piers with steel posts, rails and alternating panels

Other: Brick: 2'x2' (Height as required, equally spaced 8' to 40'), Steel posts: 4"x4" (equally spaced), Rails: 1-1/4"x1-1/2", vertical steel panels spaced alternately on each side of the rails; matching gates; close all ends

UFGS: Section 04 20 00 Unit Masonry, Section 05 50 13 Misc. Metal

C07.2.17. Tree Grates

Applicable N/A

Number of base standards 1

Image Tool 250 x 188



Type: **Cast Iron**

Applies to: Group 1 Group 2 Group 3 Group 4 Other

Mfr: Neenah Enterprises, Inc.

Color: Natural cast iron

Finish: Cast

Model #: 2-Piece, round or square

Other: N/A

UFGS: N/A

C07.2.18. Other

Applicable N/A

C08. EXTERIOR SIGNS

Comply with AF Corporate Standards for Site Development:
<http://afcfs.wbdg.org/site-development/index.html>

Comply with AF Corporate Standards for Exterior Signs:
<http://afcfs.wbdg.org/site-development/exterior-signs/index.html>

C08.1. Colors and Types

Applicable N/A Large graphics do not apply

Applicable N/A Small graphics do not apply

C08.1.1. Materials and Color Specifications

Applicable N/A Large graphics do not apply

Applicable N/A Small graphics do not apply

Materials and Color Specifications

Applicable N/A Number of base standards 3

Image Tool 250 x 188

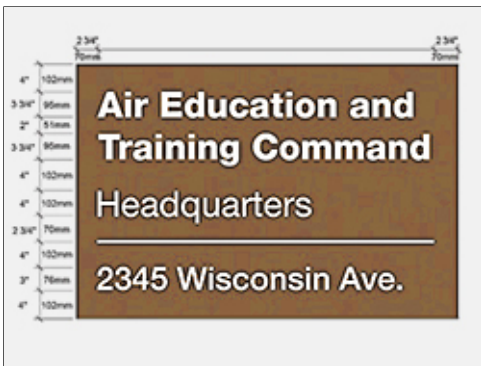

Type: **Typical Sign Fce**

Applies to: Group 1 Group 2 Group 3 Group 4 Other

Mfr: Custom

Color: Medium bronze

Finish: Matte vinyl

Model #: Aluminum flat sheet

Other: Mount to square posts. Provide sizes following UFC.

UFGS: Section 05 50 13 Miscellaneous Metal Fabrications

Type: **Typical Sign Post**

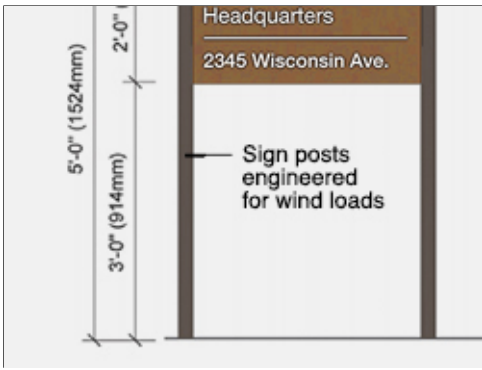

Applies to: Group 1 Group 2 Group 3 Group 4 Other

Mfr: Custom

Color: Dark bronze, powder coat finish

Finish: Matte

Model #: Extruded aluminum with capped top ends

Other: Square posts and squared ends. Provide engineered sizes.

UFGS: Section 05 50 13 Miscellaneous Metal Fabrications

Type: **Typical Sign Base**

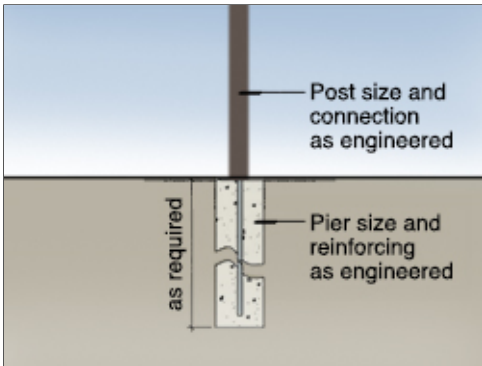

Applies to: Group 1 Group 2 Group 3 Group 4 Other

Mfr: Custom

Color: Natural Gray

Finish: Sonotube-formed

Model #: 24" height x 12" diameter, as engineered.

Other: At grade with 3/4" chamfer. Provide engineered sizes.

UFGS: UFGS 03 30 00 Cast-in-place Concrete

C08.1.2. Installation and Gate Identification Signs

Applicable N/A

Number of base standards 1

Image Tool 250 x 188

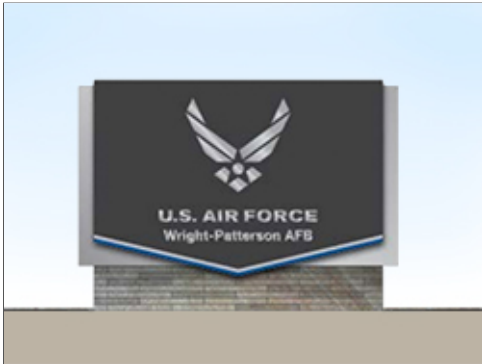

Type: **Primary, Secondary and Tertiary (Uses per UFC)**

Applies to: Group 1 Group 2 Group 3 Group 4 Other

Mfr: Custom

Color: Dark bronze, brushed aluminum, accents per UFC

Finish: Powder coat or vinyl sign face

Model #: Metal frame and panels, buff stone base

Other: White vinyl lettering. Provide dimensions per UFC. Secondary signs shall match primary sign's materials, but shall be smaller in size per UFC. Tertiary signs shall follow the UFC.

UFGS: Section 05 50 13 Miscellaneous Metal Fabrications

C08.1.3. Building Identification Signs

Applicable N/A

Number of base standards 5

Image Tool 250 x 188

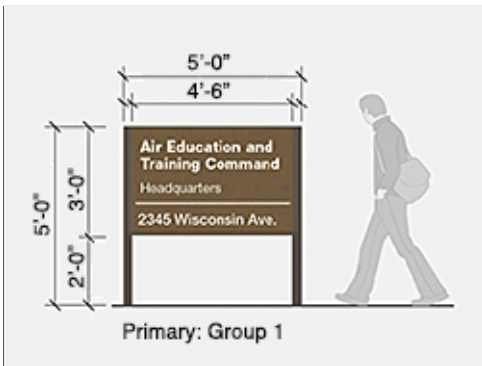

Type: **Freestanding Primary Sign (Sizes and Uses per UFC)**

Applies to: Group 1 Group 2 Group 3 Group 4 Other

Mfr: Custom

Color: Medium brown face, dark bronze posts, white vinyl lettering

Finish: Powder coat or vinyl sign face

Model #: Aluminum sheet face, extruded aluminum posts

Other: Provide layout and sizes per UFC.

UFGS: Section 05 50 13 Miscellaneous Metal Fabrications

Type: **Freestanding Secondary Sign (Sizes and Uses per UFC)**

Applies to: Group 1 Group 2 Group 3 Group 4 Other

Mfr: Custom

Color: Medium brown face, dark bronze posts, white vinyl lettering

Finish: Powder coat or vinyl sign face

Model #: Aluminum sheet face, extruded aluminum posts

Other: Provide layout and sizes per UFC.

UFGS: Section 05 50 13 Miscellaneous Metal Fabrications

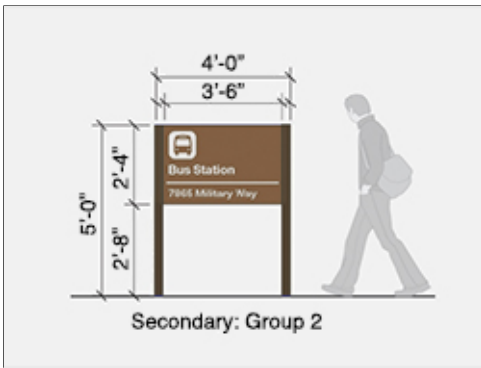

Secondary: Group 2

Type: **Freestanding Tertiary Sign (Sizes and Uses per UFC)**

Applies to: Group 1 Group 2 Group 3 Group 4 Other

Mfr: Custom

Color: Medium brown face, dark bronze posts, white vinyl lettering

Finish: Powder coat or vinyl sign face

Model #: Aluminum sheet face, extruded aluminum posts

Other: Provide layout and sizes per UFC.

UFGS: Section 05 50 13 Miscellaneous Metal Fabrications

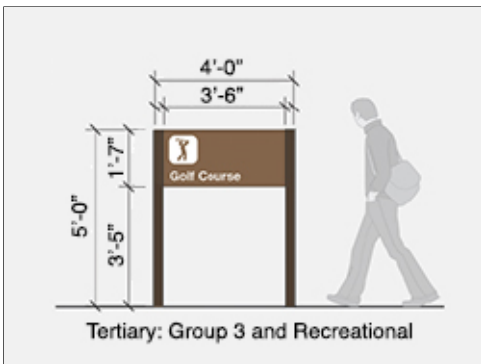

Tertiary: Group 3 and Recreational

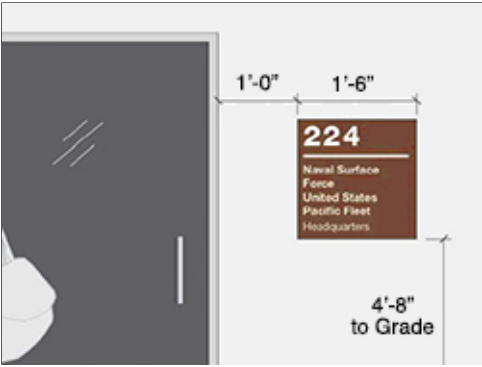

Type: **Wall Mounted**

Applies to: Group 1 Group 2 Group 3 Group 4 Other

Mfr: Custom

Color: Medium brown, white lettering

Finish: Satin vinyl applied to aluminum sheet

Model #: Aluminum sheet with vinyl face and vinyl lettering

Other: Provide layout and sizes following UFC.

UFGS: N/A



Type: **Glass Mounted**

Applies to: Group 1 Group 2 Group 3 Group 4 Other

Mfr: Custom

Color: White vinyl lettering

Finish: Matte vinyl

Model #: Machine-cut sheet vinyl

Other: Apply vinyl lettering to glass. Provide sizes following UFC.

UFGS: N/A

C08.1.4. Traffic Control Devices (Street Signs)

Applicable N/A Number of base standards 1

Image Tool 250 x 188



Type: **Street Signs**

Applies to: Group 1 Group 2 Group 3 Group 4 Other

Mfr: Custom

Color: White reflective lettering on a Standard Brown background

Finish: Powder coat or vinyl sign face

Model #: Aluminum sign face, control arm or pole mounted

Other: Mount 7' above grade minimum, pictographs and logos are prohibited on street name signs per UFC.

UFGS: Section 05 50 13 Miscellaneous Metal Fabrications

C08.1.5. Directional and Wayfinding Signs

Applicable N/A Number of base standards 2

Image Tool 250 x 188

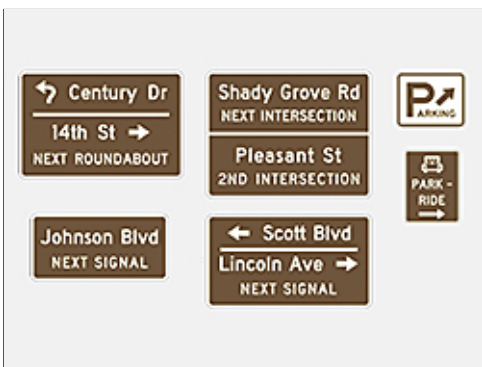

Type: **Vehicular**

Applies to: Group 1 Group 2 Group 3 Group 4 Other

Mfr: Custom

Color: Medium brown face, dark bronze posts, white reflective lettering

Finish: Powder coat or vinyl sign face

Model #: Aluminum sheet face, extruded aluminum posts

Other: Conform to the requirements of the MUTCD and its DoD Supplement. Provide types and sizes where required by UFC.

UFGS: Section 05 50 13 Miscellaneous Metal Fabrications

Type: **Pedestrian**

Applies to: Group 1 Group 2 Group 3 Group 4 Other

Mfr: Custom

Color: Medium brown face, dark bronze posts

Finish: Powder coat or vinyl sign face

Model #: Aluminum sheet face, extruded aluminum posts

Other: White vinyl lettering. Provide types and sizes where required by UFC.

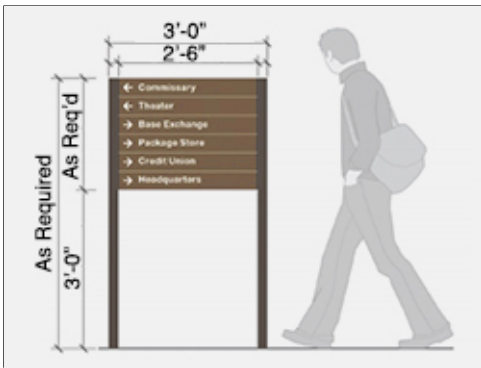

UFGS: Section 05 50 13 Miscellaneous Metal Fabrications

C08.1.6. Informational Signs

Applicable N/A Large graphics do not apply

Applicable N/A Small graphics do not apply

C08.1.7. Motivational Signage

Applicable N/A Large graphics do not apply

Applicable N/A Small graphics do not apply

C08.1.8. Parking Lot Signs

Applicable N/A

C08.1.9. Regulatory Signs

Applicable N/A

C08.1.10. Other

Applicable N/A

C09. LIGHTING

Comply with AF Corporate Standards for Site Development:

<http://afcfs.wbdg.org/site-development/index.html>

Comply with AF Corporate Standards for Lighting:

<http://afcfs.wbdg.org/site-development/lighting/index.html>

C09.1. Fixtures and Lamping

Applicable N/A Large graphics do not apply

Applicable N/A Small graphics do not apply

1. Provide, coordinate and efficiently install street, parking lot, sidewalk and facility lighting with appropriate luminaires, lamping, placement and spacing following UFC 3-530-01 and Installation Facilities Standards (IFS); ensure the level of quality is consistent with the adjacent facility group number. Pole-mounted, wall-mounted and bollard fixtures are permitted.
2. Integrate controls to automatically reduce lighting power during periods of non-activity; automatically turn off power when sufficient daylight is available.
3. Ensure continuity and consistency of lighting elements. In new construction generally match post types, fixture types, styles, heights, sizes, materials, colors, and lamp types of adjacent facilities and the facility district.
4. Economically provide renewable-energy power sources such as solar photovoltaic when feasible.
5. Use appropriately designed or shielded luminaires to direct light downward to minimize light pollution and intrusion onto adjacent sites and to facilitate night training.
6. Calculate illuminant levels for all lighting applications following UFC 3-530-01 and ensure compliance with pre-curfew maximum brightness level requirements.
7. Sufficiently address environmental factors to prevent corrosion and weathering of fixtures, plinths and other components.
8. Wall mounted fixtures should respond to the architectural character of the facility.
9. Efficient accent lighting of architectural and landscape features may be provided for Group 1, lodging and historical applications. Accent lights in ground-mounted locations may be provided for static displays and signs when these do not conflict or cause hazards with overhead aircraft.
10. Comply with UFC 3-530-01 for light source technology and lamp types. High efficiency lamping such as LED is preferred for most applications.
11. Provide round tapered, square non-tapered, or round non-tapered aluminum poles and aluminum fixtures with square, rectangular or circular housings in colors and shapes to match adjacent facilities and the facility district.
12. Install lighted bollards only at Group 1 and high-traffic Group 2 facilities. Generally match materials, colors and shapes of adjacent facilities and the facility district.
13. Install natural warm gray color, smooth finished concrete bases for all poles in heights appropriate for the facility group and application. Generally Groups 1, 2 and 4 shall have at-grade bases. Group 3 shall have taller bases for added durability.
14. When parking lot lighting is necessary, provide an illuminated path to the building's main entrance. Pole bases should be contained within an internal landscape median or island.

- 15. Consistently install lighting for sidewalks, bikeways and trails to match adjacent facilities.
- 16. Landscape accent lighting may be used in public gathering spaces and in Group 1 facilities. Coordinate the design, luminaire selection, and placement with the location of trees, shrubs, and site furnishings.
- 17. Manufacturers listed below are only provided to establish a baseline of equivalency among all applicable manufacturers.

C09.2. Light Fixture Types

Note: Apply the below base-wide standards for Light Fixtures (products, materials and color). Then refer to the Appendix and apply any additional requirements specifically related to the Facility District in which the project is located.

C09.2.1. Street Lighting

Applicable N/A Number of base standards 3

Image Tool 250 x 188

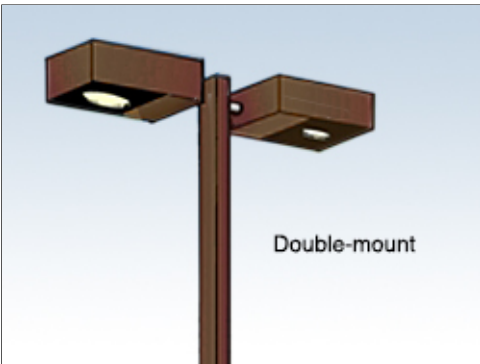

Type: **Style 1**

Applies to: Group 1 Group 2 Group 3 Group 4 Other

Mfr: Hubbell, Kim Lighting

Color: Dark Bronze Anodized (or Clear Anodized as approved by BCE)

Finish: Factory

Model #: Rectilinear Cutoff, Single Arm or Dual Arm Mount

Other: Lamp: LED. Follow manufacturer's recommendations for fixture base.

UFGS: N/A

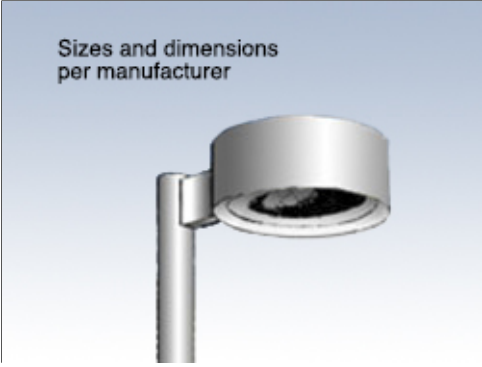

Type: **Style 2**

Applies to: Group 1 Group 2 Group 3 Group 4 Other

Mfr: Hubbell, Kim Lighting

Color: Clear Anodized as approved by BCE

Finish: Factory

Model #: Round Cutoff, Single Arm or Dual Arm Mount

Other: Lamp: LED. Follow manufacturer's recommendations for fixture base.

UFGS: N/A



Type: **Decorative LED Street Light**

Applies to: Group 1 Group 2 Group 3 Group 4 Other

Mfr: TBD

Color: Gray base wth opaque globe

Finish: Factory powder coat, natural concrete base

Model #: Historical theme

Other: N/A

UFGS: N/A

C09.2.2. Parking Lot Lighting

Applicable N/A

Number of base standards 2

Image Tool 250 x 188

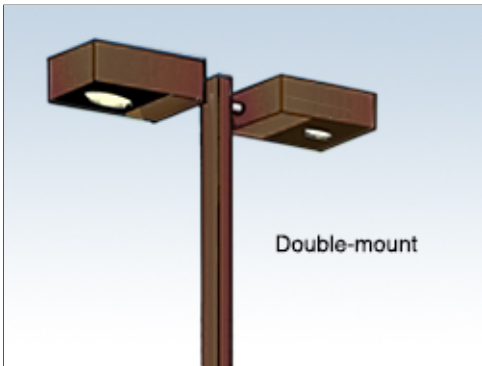

Type: **Parking Lot Style 1**

Applies to: Group 1 Group 2 Group 3 Group 4 Other

Mfr: Hubbell, Kim Lighting

Color: Dark Bronze Anodized (or Clear Anodized as approved by BCE)

Finish: Factory

Model #: Rectilinear or Round Cutoff, Single Arm or Dual Arm Mount

Other: Lamp: LED. Follow manufacturer's recommendations for fixture base.

UFGS: N/A

Type: **Parking Lot Fixture Base**

Applies to: Group 1 Group 2 Group 3 Group 4 Other

Mfr: Custom

Color: Natural gray

Finish: Trowel

Model #: Form-cast, round

Other: N/A

UFGS: Section 03 33 00 Cast-In-Place Architectural Concrete

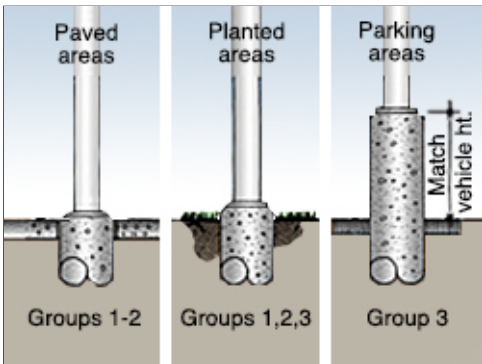

C09.2.3. Lighted Bollards

Applicable N/A

Number of base standards 2

Image Tool 250 x 188



Type: **Lighted Round Dome Top**

Applies to: Group 1 Group 2 Group 3 Group 4 Other

Mfr: Lithonia Lighting Products

Color: Dark Bronze

Finish: Anodized aluminum

Model #: KBA

Other: Flared cone, 3000K LED Lamp. Follow manufacturer's recommendations for fixture base.

UFGS: N/A



Type: **Lighted Square Sloped Top**

Applies to: Group 1 Group 2 Group 3 Group 4 Other

Mfr: Kim Lighting

Color: Platinum Silver

Finish: Anodized aluminum

Model #: VSB1 Square

Other: 3000K LED Lamp, 360° downlighting

UFGS: N/A

C09.2.4. Sidewalk Lighting

Applicable N/A

Number of base standards 1

Image Tool 250 x 188

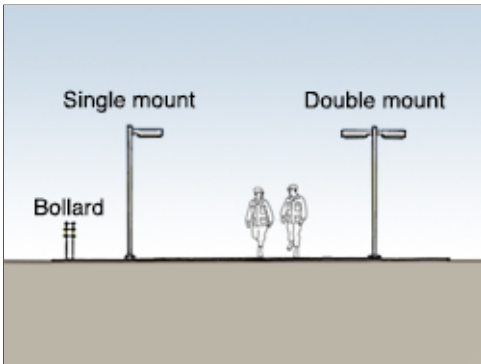

Type: **Rectilinear Cutoff**

Applies to: Group 1 Group 2 Group 3 Group 4 Other

Mfr: Hubbell, Kim Lighting

Color: Dark Bronze Anodized (or Clear Anodized as approved by BCE)

Finish: Anodized aluminum

Model #: Rectilinear Cutoff, Single Arm or Dual Arm Mount

Other: Lamp: LED. Follow manufacturer's recommendations for fixture base.

UFGS: N/A

C09.2.5. Walls / Stairs Lighting

Applicable N/A

Number of base standards 1

Image Tool 250 x 188



Type: **Style 1**

Applies to: Group 1 Group 2 Group 3 Group 4 Other

Mfr: Vista Lighting

Color: Dark bronze anodized

Finish: Smooth

Model #: Aluminum Step and Brick Lights, 5230 round louvered

Other: Lamp: LED

UFGS: N/A

C09.2.6. Other

Applicable N/A

Number of base standards 1

Image Tool 250 x 188



Type: **Marina Lighting**

Applies to: Group 1 Group 2 Group 3 Group 4 Other

Mfr: TBD

Color: White

Finish: Powder coat

Model #: Nautical theme, down light with shield

Other: For use only in Keesler Marina

UFGS: N/A

D. FACILITIES EXTERIORS

Comply with Air Force Corporate Standards for Facilities Exteriors:

<http://afcfs.wbdg.org/facilities-exteriors/index.html>

D01. SUPPORTING THE MISSION

Comply with AF Corporate Standards for Supporting the Mission:

<http://afcfs.wbdg.org/facilities-exteriors/supporting-the-mission/index.html>

D02. SUSTAINABILITY

Comply with Air Force Corporate Standards for Sustainability:

<http://afcfs.wbdg.org/facilities-exteriors/supporting-the-mission/index.html>

D03. ARCHITECTURAL FEATURES

Comply with AF Corporate Standards for Facilities Exteriors:

<http://afcs.wbdg.org/facilities-exteriors/index.html>

Comply with AF Corporate Standards for Architectural Features:

<http://afcs.wbdg.org/facilities-exteriors/architectural-features/index.html>

Insert 3 photos for each facility group.

Image Tool 250 x 188

Group 1



Group 2

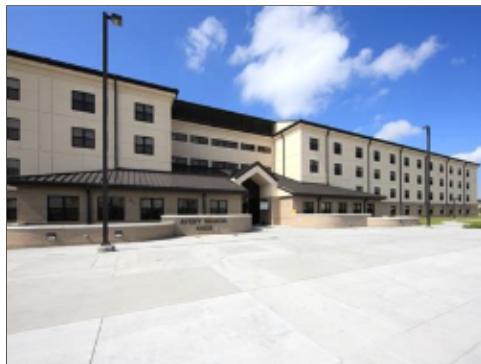

Group 3



Group 4



D03.1. Orientation, Massing and Scale

1. Orient new buildings to maximize energy efficiency, passive solar and daylighting potential of the building; narrow buildings oriented along an east-west axis are preferred to minimize heat gain in the summer months and maximize heat gain in the winter months resulting in less overall energy usage.
2. Provide orthogonal geometry for principal building form; angular geometry may be used sparingly for Group 1 and used only for emphasis at specific areas such as building entrances and stairwells.
3. Maintain a human scale and reduce the visual scale of large buildings with sub-massing related to interior functional operations; create consistent form and scale in adjacent buildings with compatible profiles or silhouettes.
4. Building heights shall comply with Airfield Surface areas.
5. Combine functions where practical to avoid a proliferation of small, independent structures.
6. Use and coordinate shading devices with orientation and for function.

D03.2. Architectural Character

1. Develop architectural features, materials and detailing appropriate for the Facility Group designation. Refer to Building Entrances, Wall Systems and Roof Systems.
2. Respond to the local climate and regional influences with environmentally functional architectural features.
3. For new facilities design generally maintain consistency and visual unity in the character of the adjacent buildings through compatible architectural features: repeated use of similar forms such as roofs, and through recurring elements such as doors, windows, materials and colors.
4. Reinforce the campus environment and educational theme with a related architectural theme expressive of innovation and technology that represents the current Air Force Training and Education Command mission.
5. All facilities shall express sustainability through their orientation, massing, shape, form, materials, and detailing. Provide louvers, fins and other shading devices to control heat gain and glare and to and improve energy efficiency.
6. Strive for economical construction without compromising a high-quality, durable, professional appearance.

D03.3. Details and Color

1. Provide a palette of earth-tone colors related to the native landscape in brick, block, stucco and powder-coated metals. Refer to wall systems for detailed material listings.
2. Relate the level of architectural detailing to the Facility Group number.
3. Use only integrally colored materials as the predominant exterior building material; do not use materials that require field painting and ongoing maintenance.
4. Provide consistent and compatible colors for every exterior building feature, including walls, roofs, doors, windows, gutters, downspouts, utility and mechanical elements, and other visible elements.
5. Noncorrosive metals with factory applied color finishes are required.
6. Combine details and color with orientation, massing, scale and architectural character to maintain base compatibility.
7. Manufacturers listed below are only provided to establish a baseline of equivalency among all applicable manufacturers.

D03.3.1. Climate-based Data and Life-Cycle Cost-Effective Passive and Natural Design Strategies:

- Climate dominated by mechanical cooling
- Climate dominated by mechanical heating
- Climate with similar mechanical cooling / heating needs
- Climate with minimal mechanical cooling / heating needs

- Climate with high humidity
- Climate with moderate humidity
- Climate with low humidity

- High Solar Insolation
- Moderate Solar Insolation
- Low Solar Insolation

- Soils with High Thermal Conductivity
- Soils with Average Thermal Conductivity
- Soils with Low Thermal Conductivity

Other: Consider the potential for flooding, high winds and salt water corrosion.

Other: First finished floor elevation should be no lower than 21 feet msl. No fill will be placed below elevation 16'0" msl.

Facility: Narrow buildings along E-W axis are preferred

Wall: Integral shading features and devices / interior masonry thermal mass walls (for cooling)

Doors: Recessed are preferred

Windows: Provide insulating glazing on all windows / maximize shading for windows on south façades

Roof: Preference is for low-sloped roofs under 1:12 slope. Slopes under 1:12 should be SBS Modified Bitumen Roof preferred. Over 1:12 slope can be metal.

Structure: Do not expose ferrous metals. Provide factory finished non-ferrous metals or concrete

MEP:

Other:

Other:

Note: Apply the below base-wide standards for Architectural Features (products, materials and color). Then refer to the Appendix and apply any additional requirements specifically related to the Facility District in which the project is located.

D03.3.2. Natural Ventilation System

Applicable N/A

Number of base standards 2

Image Tool 250 x 188



Type: **Style 1 Aluminum Windows**

Applies to: Group 1 Group 2 Group 3 Group 4 Other

Mfr: Kawneer, Coral, YKK, Vista Wall (or equivalent)

Color: Dark Bronze

Finish: Anodized

Model #: Impact rated; Fixed storefront awning

Other: Provide thermally broken frames.

UFGS: Section 08 41 13 Aluminum-Framed Entrances and Storefronts

Type: **Style 3 Aluminum-Clad Wood Windows**

Applies to: Group 1 Group 2 Group 3 Group 4 Other

Mfr: Marvin (or equivalent)

Color: Earth Tones

Finish: Factory

Model #: 4" depth, Double-hung type

Other: Section 08 14 00 Wood Doors
<http://wbdg.org/ccb/DOD/UFGS/UFGS%2004%2020%2000.pdf>

UFGS: Section 08 14 00 Wood Doors



D03.3.3. Thermal Mass

Applicable N/A

D03.3.4. Thermal Shading

Applicable N/A

Number of base standards 2

Image Tool 250 x 188



Type: **Style 1 Wall Devices**

Applies to: Group 1 Group 2 Group 3 Group 4 Other

Mfr: TBD

Color: Med Bronze

Finish: Factory, Powder Coated to match frames

Model #: Louver or awning

Other: Shading devices may be attached to frames or structure

UFGS: Section 08 41 13 Aluminum-Framed Entrances and Storefronts

Type: **Style 2 Wall Devices**

Applies to: Group 1 Group 2 Group 3 Group 4 Other

Mfr: Steelcraft (or equivalent)

Color: Medium Bronze

Finish: Factory, to match frames

Model #: louver, powder coated

Other: Shading devices may be attached to frames or structure

UFGS: Section 08 11 13 Steel Doors and Frames <http://www.wbdg.org/FFC/DO>

D03.3.5. Renewable Heating/Cooling

Applicable N/A

D03.3.6. Solar Photovoltaic System

Applicable N/A

D03.3.7. Solar Thermal System

Applicable N/A

D04. BUILDING ENTRANCES

Comply with AF Corporate Standards for Facilities Exteriors:

<http://afcs.wbdg.org/facilities-exteriors/index.html>

Comply with AF Corporate Standards for Building Entrances:

<http://afcs.wbdg.org/facilities-exteriors/building-entrances/index.html>

Insert 3 photos for each facility group.

Image Tool 250 x 188

Group 1



Group 2



Group 3



Group 4



D04.1. Primary Entrances

1. Emphasize the primary entrance in the overall building design with a projecting or recessed covering for weather protection following Installation Facilities Standards (IFS) for Facility Group designations.
2. Provide vestibules at entries in Groups 1, 2 and 3 unless used infrequently or serving unconditioned space following ASHRAE 90.1.
3. Fully integrate all elements including the design of handicap ramps in the overall design of the primary entrance in an organized uncluttered appearance.
4. Install paved transitional spaces sized for the building function and occupancy.
5. Install appropriate lighting and site furniture following ATFP and IFS.
6. Provide porte cocheres or covered drop-offs when justified for lodging and medical facilities; do not use for prestige or architectural accents.

D04.2. Secondary Entrances

1. Provide vestibules at entries in Groups 1, 2 and 3 unless used infrequently or serving unconditioned space following ASHRAE 90.1; use of stair towers as vestibules for multi-story buildings is encouraged when building and / or energy codes are satisfied.
2. Reflect the character of the primary entrance to a lesser extent with a smaller scale.
3. Include a recess or projection for weather protection and shading.
4. Integrate service and egress doors and loading areas with the building design by matching the materials and detailing and reflect the overall quality of the facility.
5. Incorporate egress structures such as stair towers into the facility design.
6. Canopies and recesses may be used for service and loading areas, including doors used for life safety purposes; weatherstripping is preferred for all openings.
7. Develop building massing and orientation to minimize the appearance of service and loading areas; physically and visually separate these from primary entrances.
8. Loading areas must be organized, orderly and have an uncluttered appearance.

D05. WALL SYSTEMS

Comply with AF Corporate Standards for Facilities Exteriors:

<http://afcfs.wbdg.org/facilities-exteriors/index.html>

Comply with AF Corporate Standards for Doors and Windows:

<http://afcfs.wbdg.org/facilities-exteriors/wall-systems/index.html>

Comply with AFCFS Recommended Materials:

<http://afcfs.wbdg.org/facilities-exteriors/wall-systems/materials/index.html>

Insert 3 photos for each facility group.

Image Tool 250 x 188

Group 1



Group 2



Group 3



Group 4



D05.1. Hierarchy of Materials

1. Group 1 facilities may have more refined detailing than Group 2 and Group 2 may have more definition than Group 3.
2. Group 1 and 2 facilities shall be predominately of brick and secondary areas of eifs. However, architectural pre-cast or split faced concrete block may also be used. Ribbed metal sheeting is acceptable.
3. Group 4 shall be a combination of two of the following materials: cementitious siding and brick.
4. Multi-story Group 1 facilities may include a transition in material, color or detailing to create a visual base. Generally limit brick and eifs to a single color on Group 2, 3 and 4 facilities.
5. Use high-performance building envelopes following UFC 1-200-02.
6. Use detailing not subject to excessive weathering. Provide wall accents consistently throughout the base.
7. Use integrally colored materials and factory-finished metals. Do not paint concrete block.
8. Translucent wall panels may be used in Facility Group 1 and recreational uses in Group 2 when protected from direct solar gain, but must meet wind and blast impact ratings. Provide insulating panels and shading appropriate for the orientation and exposure.

D05.2. Layout, Organization and Durability

1. Organize wall components including doors, windows, accents, shading devices, control joints, etc., to provide an ordered, professional appearance.
2. Integrate shading devices into the overall composition of the wall.
3. Integrate fixed shading devices as at all exterior glazing exposed to summer UV heat gain as a passive design measure to reduce energy use. Ensure adequate shading at west entrances.
4. Shading systems may be custom systems integrated into the wall.
5. Provide appropriate transitions between dissimilar materials to mitigate effects of thermal expansion and galvanic action.
6. All joint sealants shall be slightly darker than adjacent surfaces.
7. Materials requiring regular maintenance are not permitted; do not use exposed structural steel or other materials that require painting.
8. Refer to C07.2.16. Screen Walls for materials and colors of freestanding walls.
9. Refer to D07. Roofs for downspouts.

D05.3. Equipment, Vents and Devices

1. Arrange all mechanical, electrical, fire alarm, lightning protection and other system components to create an orderly appearance that integrates with the wall system.
2. Do not expose conduits, cables, piping, lightning protection components, etc. on exterior walls; if unavoidable in renovations, finish these elements to match the adjacent wall surface.
3. Avoid visual clutter and where surface-mounted elements are required they shall match the wall color.
4. All equipment, vents and devices must meet applicable wind standards for the area (including wind-driven rain).

D05.4 Wall Systems Materials

Facility Group 1 wall materials shall be as follows.

Primary: Brick with EIFS
Secondary: Architectural precast with brick
Accent: Metal panels allowed only at gables

Facility Group 2 wall materials shall be as follows.

Primary: Brick with EIFS
Secondary: Architectural precast with brick
Accent: Metal panels allowed only at Gables

Facility Group 3 wall materials shall be as follows.

Primary: Ribbed metal sheeting
Secondary: Optional: brick (in high visibility areas)
Accent: N/A

Facility Group 4 wall materials shall be as follows.

Primary: Fiber Cement Siding, Brick accents
Secondary: Fiber Cement Siding, Trim Boards
Accent: Brick Foundation Cladding

Note: Apply the below base-wide standards for Wall Systems (products, materials and color). Then refer to the Appendix and apply any additional requirements specifically related to the Facility District in which the project is located.

D05.4.1. Flat Metal Panels

Applicable N/A

D05.4.2. Brick Veneer

Applicable N/A Number of base standards 1

Image Tool 250 x 188

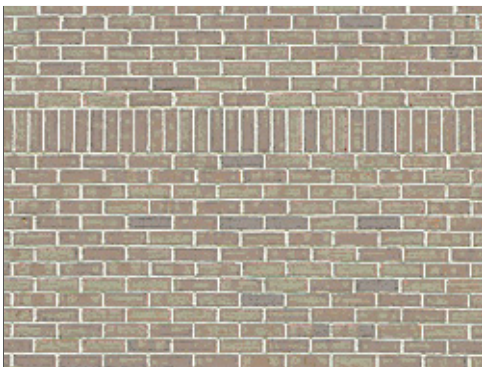

Type: **Modular Face Brick**

Applies to: Group 1 Group 2 Group 3 Group 4 Other

Mfr: Local, TBD

Model #: Modular Face Brick Boral Bricks, Inc.

Color: No. 561 Dark Gray Bartex

Finish: Straight Edges, smooth texture

Other: Nominal size: 4x8x2.6

UFGS: Section 04 20 00 Unit Masonry:
http://www.wbdg.org/FFC/DOD/UFGS/UFGS_04_20_00.pdf

D05.4.3. Architectural Precast

Applicable N/A Number of base standards 1

Image Tool 250 x 188



Type: **Coursed precast**

Applies to: Group 1 Group 2 Group 3 Group 4 Other

Mfr: Local, TBD

Model #: Smooth Casting

Color: Light Beige

Finish: Very Light texture

Other: N/A

UFGS: Section 03 45 00 Precast Architectural Concrete:
<http://www.wbdg.org/FFC/DOD/UFGS/UFGS 03 45 00.pdf>

D05.4.4. Stucco Over Sheathing

Applicable N/A

D05.4.5. Curtain Wall

Applicable N/A Number of base standards 1

Image Tool 250 x 188



Type: **Traditional Curtain Wall**

Applies to: Group 1 Group 2 Group 3 Group 4 Other

Mfr: Kawneer (or equivalent)

Model #: 1600 LR Wall™ Curtain Wall System

Color: Medium Bronze

Finish: Factory

Other: Impact rated

UFGS: Section 08 44 00 Curtain Wall and Glazed Assemblies:
<http://www.wbdg.org/FFC/DOD/UFGS/UFGS 08 44 00.pdf>

D05.4.6. Cast-In-Place Concrete

Applicable N/A

D05.4.7. Tilt-Up Concrete

Applicable N/A

D05.4.8. Ribbed Metal Sheeting

Applicable N/A Number of base standards 1

Image Tool 250 x 188



Type: **Flush Seam**

Applies to: Group 1 Group 2 Group 3 Group 4 Other

Mfr: TBD

Model #: Flush Seam Panel

Color: Tan/Bronze

Finish: Embossed Texture, factory finished

Other: 24 Gauge Steel

UFGS: Section 07 42 13 Metal Wall Panels:
<http://www.wbdg.org/FFC/DOD/UFGS/UFGS 07 42 13.pdf>

D05.4.9. EFIS

Applicable N/A Number of base standards 1

Image Tool 250 x 188



Type: **Style 1**

Applies to: Group 1 Group 2 Group 3 Group 4 Other

Mfr: Sto, Drivit or Equivalent

Model #: Barrier Type

Color: Match paint color 37769 (Cream)

Finish: Sand

Other: Not to be used within 4 feet of finished grade; Confirm class with BCE

UFGS: Section 07 24 00 Exterior Insulation and Finish Systems:
<http://www.wbdg.org/FFC/DOD/UFGS/UFGS 07 24 00.pdf>

D05.4.10. GRFC

Applicable N/A

D05.4.11. Concrete Block

Applicable N/A

D05.4.12. Fiber Cement Siding

Applicable N/A Number of base standards 1

Image Tool 250 x 188



Type: **Style 1**

Applies to: Group 1 Group 2 Group 3 Group 4 Other

Mfr: James Hardie Building Products, Inc.; Meritech

Model #: Horizontal Lap Siding, Shingle Siding, Panels

Color: Earth Tones

Finish: Wood Texture

Other: Hardie Plank, Hardie Shingle

UFGS: SECTION 074646 Fiber Cement Siding:
(Not Available on UFGS)

D05.4.13. Other

Applicable N/A

D06. DOORS AND WINDOWS

Comply with AF Corporate Standards for Facilities Exteriors:

<http://afcs.wbdg.org/facilities-exterior/index.html>

Comply with AF Corporate Standards for Doors and Windows:

<http://afcs.wbdg.org/facilities-exterior/doors-and-windows/index.html>

Comply with AFCFS Recommended Materials:

<http://afcs.wbdg.org/facilities-exterior/doors-and-windows/materials/index.html>

Insert 3 photos for each facility group.

Image Tool 250 x 188

Group 1



Group 2



Group 3



Group 4



D06.1. Types

1. Bronze anodized aluminum doors, windows and frames with thermal breaks are preferred for Facility Groups 1-3 because they match the color of the door and frame. For renovation projects the color of new windows, doors and frames may match the existing ones.
2. Aluminum clad wood windows are preferred for Facility Group 4.
3. Standard-sized hinged doors are preferred. Use sliding, folding, overhead, sectional and other door configurations only to support mission operations.
4. Automatic doors are allowed only where functionally necessary.
5. Limit hollow metal doors and frames to security doors, utility rooms and mechanical rooms in Groups 1 and 2 and to any application in Group 3 facilities.
6. Passive thermal comfort methods of ventilation are encouraged where life cycle cost justified.
7. Windows must meet force protection requirements and applicable hurricane codes.
8. Adjacent joint sealants should be slightly darker than the frame color.
9. Exterior doors with louvered vents should have bug screens for the vents.
10. Manufacturers listed below are only provided to establish a baseline of equivalency among all applicable manufacturers.

D06.2. Layout and Geometry

1. Visually and functionally compose openings in walls for the climate-specific exposure.
2. Consistently use opening type, size, placement, mullion pattern, and color to reinforce the overall architectural design.
3. Openings shall augment interior lighting and space conditioning needs.
4. Protect against vandalism, intrusion and coordinate sound ratings.

D06.3. Glazing and Shading

1. Tinted, energy-efficient, low-e, double-pane glazing is encouraged; provide triple-pane glazing in extreme environments.
2. Glazing color shall follow Installation Facilities Standards (IFS).
3. Translucent wall panels may be integrated into wall systems.
4. Do not use mirrored glazing.
5. Fully integrate applicable shading designs for overhangs, louvers, light shelves and grilles.
6. Where appropriate, install window screens to take advantage of natural ventilation.

D06.4. Hardware

1. Provide hardware appropriate for the Facility Group while considering activity and frequency of use and local climate; hardware may be of higher visual quality for Facility Group 1.
2. Ensure hardware will perform throughout the facility's lifespan without showing extreme wear.
3. Select finishes that will not degrade by intensity of operation or exposure to the elements.

- 4. Use consistent finishes and color on window and door systems throughout a facility. For renovation projects the color of new hardware may match the existing hardware.
- 5. Design building systems to eliminate the need for security screens whenever possible.

D06.5. Doors and Windows Materials

Note: Apply the below base-wide standards for Doors and Windows (products, materials and color). Then refer to the Appendix and apply any additional requirements specifically related to the Facility District in which the project is located.

D06.5.1. Anodized Aluminum

Applicable N/A Number of base standards 1

Image Tool 250 x 188



Type: **Anodized Aluminum Doors, Windows and Frames**

Applies to: Group 1 Group 2 Group 3 Group 4 Other

Mfr: Kawneer, Coral, YKKK (or equivalent)

Color: Medium Bronze

Finish: Anodized Factory Finish

Model #: 2x4

Other: Provide thermally broken frames

UFGS: Section 08 41 13 Aluminum-Framed Entrances and Storefronts:
<http://www.wbdg.org/FFC/DOD/UFGS/UFGS 08 41 13.pdf>

D06.5.2. Hollow Metal

Applicable N/A

Number of base standards 1

Image Tool 250 x 188



Type: **Welded Metal Frames, Steel Doors**

Applies to: Group 1 Group 2 Group 3 Group 4 Other

Mfr: Hollow Metal Doors, Windows and Frames

Color: TBD

Finish: Powder Coated, Satin

Model #: 2x4 frame

Other: Provide thermally broken frames

UFGS: Section 08 11 13 Steel Doors and Frames:
<http://www.wbdg.org/FFC/DOD/UFGS/UFGS 08 11 13.pdf>

D06.5.3. Aluminum-clad Wood

Applicable N/A

Number of base standards 1

Image Tool 250 x 188



Type: **Aluminum-clad Residential**

Applies to: Group 1 Group 2 Group 3 Group 4 Other

Mfr: Marvin

Color: White or Earth tones

Finish: Powder coated, satin

Model #: Aluminum-clad wood windows

Other: Double hung

UFGS: Section 08 14 00 Wood Doors
<http://www.wbdg.org/FFC/DOD/UFGS/UFGS 08 14 00.pdf>

D06.5.4. Other

Applicable N/A

Number of base standards 1

Image Tool 250 x 188

Type: **Metal Storm Shutters**

Applies to: Group 1 Group 2 Group 3 Group 4 Other

Mfr: TBD

Color: Dark Bronze

Finish: Powder Coat

Model #: Coiling, horizontal slat

Other: Exterior Mount

UFGS: N/A



D07. ROOF SYSTEMS

Comply with AF Corporate Standards for Facilities Exteriors:

<http://afcs.wbdg.org/facilities-exterior/index.html>

Comply with AF Corporate Standards for Roof Systems:

<http://afcs.wbdg.org/facilities-exterior/roof-systems/index.html>

Comply with AFCFS Recommended Materials:

<http://afcs.wbdg.org/facilities-exterior/roof-systems/materials/index.html>

Insert 3 photos for each facility group.

Image Tool 250 x 188

Group 1



Group 2



Group 3



Group 4



D07.1. Roof Type and Form

1. Use proven, cost-effective roof systems with high durability, weather resistance, and low maintenance that are compatible with Installation Facilities Standards (IFS) and requirements for the designated Facility Group.
2. Generally match the roof type and form of existing adjacent facilities in new construction.
3. Group 1 and 2 buildings shall use hip roofs (3:12 slope recommended). Buildings in Group 1 may also have hip and gable type roofs (3:12 slope recommended) such as a sloped standing seam metal roof. Low slope membrane roof can be used on a case by case basis.
4. Provide screens for roof-mounted appendages and equipment of the same materials, which are used predominantly in the building's roof systems.
5. Group 2 and 3 facilities under 5,000 sf and narrow in plan geometry, may use hip and gable or hipped standing seam metal (type) (i.e., low-sloped shed, gabled or hipped standing seam metal) roofs. Larger facilities may use sloped-roof features in conjunction with predominantly minimal-sloped "flat" membrane roofs.
6. Group 4 facilities shall have gabled or hipped composite shingle roofs.
7. Roof eaves shall extend beyond the exterior wall for roof drainage and shading. Provide overhangs for shading in response to local climatic conditions, sized and proportioned to the height of the facility and to the window openings being shaded.
8. South-facing eaves shall coordinate with adjacent wall-mounted shading devices.
9. The color, shape and slope of the eave and soffit shall be compatible with adjacent facilities.
10. Keep roofs uncluttered and minimize penetrations and slope changes. Provide adequate transition flashing at walls and roof features.
11. Diminish massive roofs into coordinated smaller components consistent with adjacent facilities; avoid random, arbitrary changes.
12. Increase the insulation value of existing roofing systems during renovations if supported by life cycle cost and structural analysis.
13. Roofs shall be maintained for the life of the system and replaced in accordance with UFC 3-110-04 and AFI 32-1051. A warranty is required on all new roofs.
14. Manufacturers listed below are only provided to establish a baseline of equivalency among all applicable manufacturers.

D07.2. Roof Slope

1. Group 1 and 2 buildings shall use sloped roofs, min. 3:12.
2. Low-sloped roofs are allowed for larger structures or to match existing conditions on renovation projects. Minimal-sloped roofs may also be used for Group 3 facilities in high-visibility areas.
3. Group 4 facilities shall use 4:12 to 6:12 roof slopes.
4. Ensure adequate drainage, and connect to the subsurface rain collection system where available.
5. Provide roof slopes to accommodate solar photovoltaic, solar thermal, passive systems and daylighting when applicable following UFC 1-200-02.
6. Provide underlayments as required for the roofing type as directed by the UFC.

D07.3. Parapets and Copings

1. Extend wall materials vertically above the roof line and provide metal copings to match the wall. Ensure copings are properly flashed and detailed to avoid roof leaks.

D07.4. Color and Reflectivity

1. Sloped standing seam metal (i.e., sloped) roofs in Groups 1 and 2 and smaller facilities in Group 3 shall be medium bronze to match adjacent facilities and follow requirements of IFS.
2. All minimal-slope membrane roofs shall use only use high-albedo, high reflectivity color to help decrease the temperature around the buildings and minimize damage to human and wildlife habitat. Use of muted colors instead of high reflectivity colors is permitted adjacent to the airfield.
3. Sloped roofs in Group 4 shall match existing colors (i.e., earth tones).
4. Comply with UFC 3-110-03 and ASHRAE 90.1 for Solar Reflectance Index (SRI) and thermal requirements.
5. All roof flashing shall match the color of the predominant background material.

D07.5. Gutters, Downspouts, Scuppers, Drains

1. All sloped roofs shall use gutters and downspouts. Gutters shall be outside the fascia.
2. Internal roof drainage systems are not permitted in new construction. Minimal-sloped roofs shall be sloped to drain to the building perimeter through scuppers into downspouts.
3. All gutters and fascias shall match the roof color.
4. Size the roof drainage system per IBC and SMACNA for the region.
5. Use scuppers as required in parapet walls. Arrange scuppers in an orderly manner consistent with other elements of the wall system.
6. When open scuppers are connected to downspouts, provide transitions consistent with adjacent facilities.
7. Integrate downspouts with the architectural details of the wall system and arrange in an orderly, non-prominent appearance. Generally blend downspouts with the color of the wall (not contrasting it).
8. Fabricate downspouts from non-corrosive materials such as aluminum or zinc-coated steel. Provide powder-coated finishes in medium bronze.
9. All downspouts shall be solid.
10. Provide angled transitional pieces for downspouts to fit closely against the wall for their entire length.
11. Coordinate locations of downspouts to conceal control joints in masonry walls when possible.
12. Place downspouts away from building entries. Water discharged should not run across sidewalks.

D07.6. Roof Vents and Elements

1. Minimize and consolidate roof penetrations into a single, inconspicuous point whenever possible.
2. On sloped roofs clad pipe penetrations to match the roofing material.

3. Avoid the use of rooftop mechanical equipment, however for renovations and unavoidable configurations ensure units are screened.
4. Provide access points and service routes to equipment that protect the roof.
5. Screen all large vents.
6. Ensure attic spaces are properly vented at ridges and soffits.
7. Match roof color for all exposed equipment and vents.
8. Avoid roof-mounted antenna systems.
9. Arrange Lightning Protection Systems (LPS) components in an ordered, uncluttered, inconspicuous appearance and integrated into the organization of the roof and wall systems.
10. Ensure that LPS roof mounting systems are approved by the roofing manufacturer.
11. Additions to a roof shall not interfere with LPS or other rooftop systems that may be required.
12. Permanent fall protection shall be included with any addition to a roof with a slope above 3:12 per UFC 3-110-03 to a roof with a slope above 3:12 per UFC 3-110-03.

D07.7. Clerestories and Skylights

1. Clerestories are permitted in Group 1 facilities. These are allowed in Group 3 facilities only when serving passive systems and are justifiable by life-cycle analysis.
2. Use of skylights is not encouraged.
3. Design clerestories using the same principles for seasonal shading that are required for walls and roof overhangs.
4. Translucent panel systems are preferred in clerestory applications due to lack of window cleaning.
5. Clerestories must comply with UFC 4-10-01.

D07.8. Vegetated Roof

1. Not applicable.

D07.9. Roof Systems Materials

Note: *Apply the below base-wide standards for Roof Systems (products, materials and color). Then refer to the Appendix and apply any additional requirements specifically related to the Facility District in which the project is located.*

D07.9.1. Standing Seam Metal

Applicable N/A Number of base standards 1

Image Tool 250 x 188



Type: **Style 1**

Applies to: Group 1 Group 2 Group 3 Group 4 Other

Mfr: Berridge

Color: Medium bronze

Finish: Matte

Model #: Tee-Panel

Other: Shed, gabled or hipped standing seam metal

UFGS: Section 07 61 14 Steel Standing Seam Roofing
<http://www.wbdg.org/FFC/DOD/UFGS/UFGS 07 61 14.00 20.pdf>

D07.9.2. Membrane Single-ply

Applicable N/A

D07.9.3. Built-up Multi-ply

Applicable N/A Number of base standards 1

Image Tool 250 x 188



Type: **Type 1**

Applies to: Group 1 Group 2 Group 3 Group 4 Other

Mfr: TBD

Color: White

Finish: High Reflectivity

Model #: SBS 3 Ply Modified

Other: High reflectivity unless building is located adjacent to the airfield.

UFGS: Section 07 51 13 Built-Up Asphalt Roofing
<http://www.wbdg.org/FFC/DOD/UFGS/UFGS 07 51 13.pdf>

D07.9.4. Concrete Tile

Applicable N/A

D07.9.5. Clay Tile

Applicable N/A

D07.9.6. Slate Shingles

Applicable N/A

D07.9.7. Vegetated System

Applicable N/A

D07.9.8. Ribbed Metal Sheeting

Applicable N/A Number of base standards 1

Image Tool 250 x 188

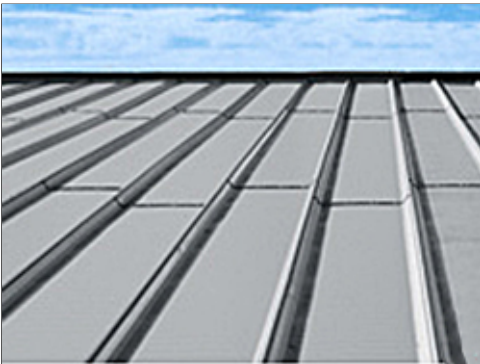

Type: **Style 1**

Applies to: Group 1 Group 2 Group 3 Group 4 Other

Mfr: Berridge

Color: Medium Bronze

Finish: Factory Aluminum

Model #: R-Panel

Other: 24 gauge steel, Width: 16" Batten height: 1-3/4"

UFGS: Section 07 41 13.19 Batten-Seam Metal Roof Panels
(Not Available on UFGS)

D07.9.9. Composite Shingles

Applicable N/A

Number of base standards 1

Image Tool 250 x 188



Type: **Style 1**

Applies to: Group 1 Group 2 Group 3 Group 4 Other

Mfr: Tamko

Color: Earth Tones; Match existing

Finish: Factory

Model #: Heritage/ 3 Tab Architectural Shingle

Other: Gabled or hipped with transverse gable or hipped features

UFGS: Section 07 31 13 Glass-fiber-reinforced Asphalt Shingles
<http://www.wbdg.org/FFC/DOD/UFGS/UFGS 07 31 13.pdf>

D07.9.10. Other

Applicable N/A

D08. STRUCTURAL SYSTEMS

Comply with AF Corporate Standards for Facilities Exteriors:

<http://afcs.wbdg.org/facilities-exteriors/index.html>

Comply with AF Corporate Standards for Structural Systems:

<http://afcs.wbdg.org/facilities-exteriors/structural-systems/index.html>

Comply with AFCFS Recommended Materials:

<http://afcs.wbdg.org/facilities-exteriors/structural-systems/materials/index.html>

Insert 3 photos for each facility group.

Image Tool 250 x 188

Group 1



Group 2



Group 3



Group 4



D08.1. Systems and Layouts

1. Pre-engineered structural steel framing may be used for Groups 1, 2 and 3 facilities; Installation-appropriate thermal envelopes, materials and detailing are required.
2. Select economical structural systems that integrate roof and wall systems.
3. Narrow buildings 60' or less in width with column-free interiors are preferred for office, administrative and personnel spaces; when interior columns are required optimize the structural grid layout for open-plan arrangements.
4. Fully coordinate structural grids with exterior window systems to align columns with window frames or wall systems.
5. When structure is exposed provide an organized appearance and coordinate with mechanical, electrical, plumbing, fire protection, information technology, and communications systems.
6. Limit the use of specialty systems (such as space frames, vaults or domes) and of structure as a visual feature.

D08.2. Structural Systems Materials

Note: Apply the below base-wide standards for Structural Systems (products, materials and color). Then refer to the Appendix and apply any additional requirements specifically related to the Facility District in which the project is located.

D08.2.1. Concrete

Applicable N/A

Number of base standards 1

Image Tool 250 x 188



Type: **Type 1**

Applies to: Group 1 Group 2 Group 3 Group 4 Other

Mfr: TBD

Color: TBD

Finish: TBD

Model #: TBD

Other: N/A

UFGS: Section 03 30 53 Miscellaneous Cast-In-Place Concrete
<http://www.wbdg.org/FFC/DOD/UFGS/UFGS 03 30 53.pdf>
Section 03 33 00 Cast-In-Place Architectural Concrete
<http://www.wbdg.org/FFC/DOD/UFGS/UFGS 03 33 00.pdf>
Section 03 47 13 Tilt-Up Concrete
<http://www.wbdg.org/FFC/DOD/UFGS/UFGS 03 47 13.pdf>

D08.2.2. Insulated Concrete Forming (ICF)

Applicable N/A

D08.2.3. Steel

Applicable N/A

Number of base standards 1

Image Tool 250 x 188



Type: **Type 1- Structural Steel**

Applies to: Group 1 Group 2 Group 3 Group 4 Other

Mfr: Varies

Color: TBD

Finish: TBD

Model #: TBD

Other: N/A

UFGS: Section 05 12 00 Structural Steel

<http://www.wbdg.org/FFC/DOD/UFGS/UFGS 05 12 00.pdf>

D08.2.4. Pre-Engineered Steel

Applicable N/A

Number of base standards 1

Image Tool 250 x 188



Type: **Type 1**

Applies to: Group 1 Group 2 Group 3 Group 4 Other

Mfr: TBD

Color: If Exposed; Medium Bronze

Finish: If Exposed- Painted; If Not Exposed- Primed

Model #: TBD

Other: N/A

UFGS: Section 13 12 00 Steel Building Systems

(Not Available on UFGS)

Section 13 34 19 Metal Building Systems

<http://www.wbdg.org/FFC/DOD/UFGS/UFGS 13 34 19.pdf>

D08.2.5. Masonry

Applicable N/A

Number of base standards 1

Image Tool 250 x 188



Type: **Brick and Block**

Applies to: Group 1 Group 2 Group 3 Group 4 Other

Mfr: Boral

Color: No. 561 Dark Gray Bartex

Finish: Running Bond with Soldier Course Accents

Model #:

Other:

UGFS: Section 04 20 00 Unit Masonry

<http://www.wbdg.org/FFC/DOD/UGFS/UGFS 04 20 00.pdf>

D08.2.6. Heavy Timber

Applicable N/A

D08.2.7. Light-gauge Steel

Applicable N/A

Number of base standards 1

Image Tool 250 x 188



Type: **Type 1**

Applies to: Group 1 Group 2 Group 3 Group 4 Other

Mfr: TBD

Color: TBD

Finish: TBD

Model #: TBD

Other: Infill Only, Structural Steel Framing preferred

UGFS: Section 05 45 00 Light Gauge Steel Framing System
(Not Available on UFGS)

D08.2.8. Lumber Framing

Applicable N/A

Number of base standards 1

Image Tool 250 x 188



Type: **Type 1**

Applies to: Group 1 Group 2 Group 3 Group 4 Other

Mfr: TBD

Color: N/A

Finish: N/A

Model #: N/A

Other: N/A

UFGS: Section 06 10 00 Rough Carpentry
http://www.wbdg.org/FFC/DOD/UFGS/UFGS_06_10_00.pdf
Section 06 11 00 Wood Framing and Sheathing
(Not Available on UFGS)

D08.2.9. Other

Applicable N/A

D09. MECHANICAL, ELECTRICAL AND PLUMBING

Comply with AF Corporate Standards for Facilities Exteriors:

<http://afcs.wbdg.org/facilities-exteriors/index.html>

Comply with AF Corporate Standards for Mechanical, Electrical and Plumbing:

<http://afcs.wbdg.org/facilities-exteriors/mechanical-electrical-and-plumbing/index.html>

Insert 3 photos for each facility group.

Image Tool 250 x 188

Group 1



Group 2



Group 3



Group 4



D09.1. Passive and Active Systems

1. Fully integrate passive heating and cooling systems into facility designs whenever practical for the local climate prior to the design of active mechanical systems.
2. Provide optimized passive and active systems; design active mechanical systems to supplement thermal mass walls and floors.
3. Develop renewable energy systems including geo-exchange (ground source heat pumps) when life cycle cost effective.
4. Performance display screens, which report energy performance and utility savings, are encouraged; when provided locate these in building lobbies or common areas.
5. Solar domestic hot water systems are required when life cycle cost effective for the climate.
6. Integrate shading into building exteriors to reduce solar heat gain during hot seasons.

D09.2. Functionality and Efficiency

1. Fully coordinate mechanical, electrical, plumbing (MEP) and fire protection systems with each other and with the building structure, enclosure, thermal envelope and interior design.
2. Ensure direct exterior access is provided (for CE) to main mechanical and electrical rooms.
3. Screen exterior equipment from primary views (landscape, building masses, screen walls) and comply with ATEP requirements.
4. Keep equipment away from main building entrances; locate service area/yard on least visible side of a building.
5. Coordinate the location of all exterior meters, equipment and devices to provide convenient access and an overall coordinated and orderly appearance.
6. Design emergency generator systems integrally with all other building systems and avoid incompatible building additions; locate generators near service areas and ensure they are not visible from primary entrances. Do not locate emergency generator systems adjacent to fresh air intakes.
7. When structure is exposed as a finished ceiling, fully integrate MEP and fire protection systems to provide an organized uncluttered appearance.
8. Conceal ducts, piping, conduits, devices, etc., when permanent walls, suspended ceilings or raised floors are provided; locate sprinkler heads in orderly configuration.
9. Limit interior wall-mounted equipment in occupied personnel spaces; avoid surface-mounted conduit and pipes.
10. Provide efficient utility rooms with layouts to facilitate system performance and maintenance; provide convenient access to controls, clearly label systems and include operating and maintenance instructions. Ensure clearances are identified and maintained for maintenance purposes.
11. Separate mechanical and electrical and communications rooms.
12. Integrate recessed and wall-mounted fixtures such as fire standpipe cabinets and drinking fountains within permanent walls.

E. FACILITIES INTERIORS

Comply with Air Force Corporate Standards for Facilities Interiors:
<http://afcs.wbdg.org/facilities-interiors/index.html>

Insert 3 photos for each facility group.

Image Tool 250 x 188

Group 1

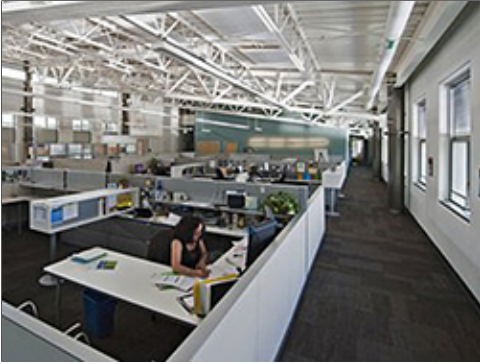

Group 2

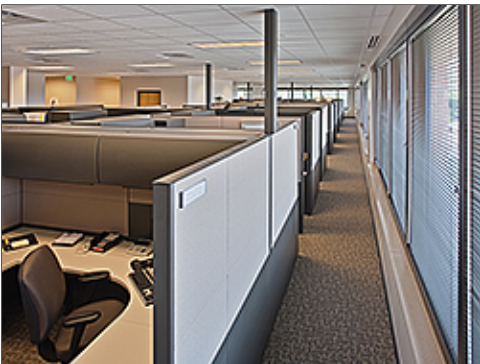

Group 3



Group 4



E01. Building Configurations

Comply with Air Force Corporate Standards for Building Configurations:

<http://afcfs.wbdg.org/facilities-interiors/buildings-configurations/index.html>

1. Provide open-plan configurations for office, administrative, operational and related activities and spaces for maximum flexibility. Use a “core and shell” approach in which all building systems, infrastructure and permanent interior partitions anticipate two or more uses (operations) during a facility’s lifespan.
2. Create flexible interior configurations using Furniture, Fixtures & Equipment (FF&E) and limit private offices and private rooms. Refer to AFMAN 32-1084 for space requirements. To the greatest extent, limit permanent partitions to core areas such as toilet rooms, stairs, mechanical and utility rooms.
3. Use more durable long-lasting finishes in core areas for walls, ceilings, floor coverings and built-in casework. Coordinate interior FF&E layouts with structural grids during space planning.
4. Provide high-performance building configurations following UFC 1-200-02. Ensure passive design strategies are cost effectively incorporated before active mechanical systems are designed.
5. Comply with UFC 1-200-01, general building requirements. UFC 1-200-01 provides applicability of model building codes and government unique criteria for typical design disciplines and building systems, as well as for accessibility, antiterrorism, security, high performance and sustainability requirements, and safety.
6. Meet security and force protection requirements in UFC 4-010-01: DoD Minimum Antiterrorism Standards for Buildings.
7. Comply with AFCFS for supporting mission requirements, addressing human comfort and well being, and creating highly flexible interiors while satisfying metrics for high performance and sustainable buildings.
8. Provide a level of quality for interior features, materials and finishes that is appropriate for the Facility Group number. Group 1 may receive higher quality than Groups 2 thru 4. Refer to Facility Hierarchy.
9. Through open-plan configurations, preserve all passive and natural design strategies and fully integrate facility interiors with overall building systems.
10. Professional interior designers, or architects with significant interior design experience, must accomplish the design and review of applicable new construction, renovations and maintenance projects.
11. Consult with the State Historic Preservation Officer (SHPO) and base-level Historic Preservation offices regarding proposed changes to properties listed on or eligible for listing on the National Register of Historic Places. Follow requirements of The National Historic Preservation Act and Secretary of the Interior Standards for the Treatment of Historic Properties.
12. Maintain architectural compatibility following AFCFS and this Installation Facilities Standards (IFS) document to create continuity while avoiding monotony.

E01.1. Layout and Common Areas

Comply with Air Force Corporate Standards for Layout and Common Areas:

<http://afcfs.wbdg.org/facilities-interiors/buildings-configurations/layout-and-common-areas/index.html>

1. Create open-plan interior environments to accommodate changes.
2. Limit interior partitions, private offices and rooms; use furniture or modular systems to provide privacy and acoustic control. Partitions for modular systems shall not be installed in locations that cause the effectiveness of fire alarm suppression systems and alarms and mechanical systems to be reduced.
3. When partitions are functionally justified such as for conference rooms, use systems furniture and moveable (demountable) floor-to-ceiling wall systems for acoustical or visual privacy.
4. Proportion lobbies and common spaces based on type of function, activity and facility group.

5. Allow no direct sight lines into restrooms.
6. Situate utility and core areas to minimize impact on daylighting and to maximize use as thermal buffers.
7. Ensure electrical, lighting and communications system can be adaptable to configuration changes.
8. Avoid power poles to the maximum extent; when poles are necessary minimize the number and coordinate locations with furniture placement and other elements.
9. Avoid sloping floors to maintain flexibility and eliminate future structural changes.
10. Special consideration may apply to Sensitive Compartmented Information Facilities (SCIFs).

E01.1.1. Interior Design Process

1. Comply with UFC 3-120-10 for the Comprehensive Interior Design (CID,) which includes both Structural Interior Design (SID) and Furniture, Fixtures & Equipment (FF&E) design services.
2. Use a collaborative, integrated planning and design team, composed of user, government support staff, and appropriate professionals. Integrate architectural features using simple detailing to create a professional appearance; avoid extravagant or excessive detailing.
3. Ensure interior designs satisfy the functional requirements within the context of flexibility, sustainability and the building's energy performance.
4. Base space planning on square foot allocations from AFM 32-1084. Identify special requirements if any, such as privacy separation, VIP areas, gathering spaces and storage. Note: The occupant's rank and position will influence the square footage and selection of materials.
5. Provide clear circulation and pathway finding for both horizontal and vertical directions that accommodate the number of personnel in the facility and maintain required egress according to applicable codes.
6. Maximize efficiencies in the space plan for functional relationships and adjacencies for all facility users. Efficiently create and situate rooms and support rooms such as conference / meeting rooms and break rooms.
7. Provide interior design building-related illustrations, drawings, schedules, materials selections, specifications and cost estimates as listed in UFC 3-120-10. Refer to Furnishings in this IFS also.
8. SID Format shall follow HQ AFCEC standards.
9. Base the FF&E package on the furniture footprint developed in the SID. Identify all new or existing equipment needed and its users within each facility or each area of the facility. Provide specific information on: equipment sizes, electrical requirements, ventilation requirements, weight (if heavy), quantity, and security level if required. Presume all administrative spaces have computers and supporting equipment.

E01.1.2. Codes and Regulations

1. Refer to UFC 1-200-01 for modifications to the International Building Code (IBC) to determine applicable sections of the IBC. Both the IBC Chapter 3 and UFC 3-600-01 govern "Use and Occupancy Classification" for example.
2. Fire code requirements shall be as defined in the International Building Code (IBC) and must be used where dictated by UFC 1-200-01 DoD Building Code (General Building Requirements) except where noted in UFC 3-600-01 (Fire Protection Engineering For Facilities).
3. National Fire Protection Association (NFPA) 101 must be utilized to determine the occupancy classification as it relates to fire/smoke resistance rating of interior non-load bearing partitions (other than occupancy separation), means of egress, interior finish, features of fire protection (including vertical openings) and associated requirements.

E01.2. Quality and Comfort

Comply with Air Force Corporate Standards for Quality and Comfort:

<http://afcs.wbdg.org/facilities-interiors/buildings-configurations/quality-and-comfort/index.html>

1. Include durability in the life cycle cost analysis for best-value material selections with long life expectancies that do not show excessive wearing.
2. Select long-lasting materials and finishes for permanent core areas such as lobbies, restrooms and stairs.
3. Select low-maintenance materials and products that reduce ongoing servicing and repair and that are easy to clean.
4. Relate the visual quality of finishes to the Facility Group number.
5. Building and interior configurations should address both operations and climatic responses.
6. Convey a professional image; avoid trendy patterns and textures.
7. Use materials and finishes that provide a healthy indoor environment.
8. Orient interior spaces toward views while maintaining cost-effective building performance and efficiency.
9. Promote air movement and daylighting for human health and wellbeing.

E02. Floors

Comply with Air Force Corporate Standards for Floors:

<http://afcs.wbdg.org/facilities-interiors/floors/index.html>

E02.1. Floor Materials

Facility Group 1 floor materials shall be as follows.

Primary: Porcelain tile
Secondary: Carpet, Rubber Stair Treads
Tertiary: Prepared Slabs (Ground, Polished)

Facility Group 2 floor materials shall be as follows.

Primary: Ceramic tile
Secondary: Carpet, Rubber Stair Treads
Tertiary: Prepared Slabs (Ground, Polished)

Facility Group 3 floor materials shall be as follows.

Primary: Prepared Slabs (Ground)
Secondary: Prepared Slabs (Sealer)
Tertiary: VCT

Facility Group 4 floor materials shall be as follows.

Primary: Carpet
Secondary: Ceramic tile
Tertiary: N/A

1. Natural stone and terrazzo flooring with high slip coefficient may be used in high traffic areas of Group 1 as approved on a case by case basis.
2. Resilient and rapidly renewable flooring may be used in low traffic areas in Group 1, 2 and 4.

3. Manufacturers listed below are only provided to establish a baseline of equivalency among all applicable manufacturers.

Note: Apply the below base-wide standards for Floors (products, materials and color). Then refer to the Appendix and apply any additional requirements specifically related to the Facility District in which the project is located.

E02.1.1. Prepared Slabs

Applicable N/A Number of base standards 3

Image Tool 250 x 188



Type: **Style 1, Ground and Polished**

Applies to: Group 1 Group 2 Group 3 Group 4 Other

Mfr: Local (TBD)

Color: Natural gray cement, light to dark beige aggregates

Finish: Fine polished texture

Model #: Medium to small aggregate

Other: BCE Approval

UFGS: Section 03 35 45 Polished Concrete Finishing
(Not Available on UFGS)

Type: **Natural Slab with Sealant or Epoxy Coating**

Applies to: Group 1 Group 2 Group 3 Group 4 Other

Mfr: Local (TBD)

Color: Natural gray cement, light to dark beige aggregates

Finish: Medium polished texture, slip resistant or Epoxy Coating

Model #: Medium to small aggregate

Other: BCE Approval

UFGS: Section 03 35 45 Polished Concrete Finishing
(Not Available on UFGS)



Type: **Natural Slab with Sealant or Epoxy Coating**

Applies to: Group 1 Group 2 Group 3 Group 4 Other

Mfr: Local (TBD)

Color: BCE Approval

Finish: Medium polished texture, slip resistant or epoxy coating

Model #: BCE Approval

Other: BCE Approval



UFGS: Section 03 35 45 Polished Concrete Finishing
(Not Available on UFGS)

E02.1.2. Natural Stone and Terrazzo

Applicable N/A Number of base standards 1

Image Tool 250 x 188

Type: **Slate or Travertine Tile**

Applies to: Group 1 Group 2 Group 3 Group 4 Other

Mfr: TBD

Color: Approved by BCE

Finish: TBD

Model #: TBD

Other: N/A



UFGS: Section 09 63 40 Stone Flooring
(Not Available on UFGS)
Section 09 66 13 Portland Cement Terrazzo Flooring
<http://www.wbdg.org/FFC/DOD/UFGS/UFGS 09 66 13.pdf>

E02.1.3. Quarry Tile

Applicable N/A

Number of base standards 1

Image Tool 250 x 188



Type: **Style 1**

Applies to: Group 1 Group 2 Group 3 Group 4 Other

Mfr: Daltile

Color: Earth tones

Finish: Matte, slip resistant

Model #: N/A

Other: Use in commercial kitchen flooring. Use in dormitories on a case by case basis.

UFGS: Section 09 30 10 Ceramic, Quarry, and Glass Tiling
<http://www.wbdg.org/FFC/DOD/UFGS/UFGS 09 30 10.pdf>

E02.1.4. Ceramic Tile

Applicable N/A

Number of base standards 2

Image Tool 250 x 188



Type: **Style 1 Porcelain**

Applies to: Group 1 Group 2 Group 3 Group 4 Other

Mfr: Daltile

Color: Earth tones

Finish: Matte, slip resistant

Model #: Porcelain tile

Other: Use in high traffic areas. Epoxy grout is recommended. Seal with Clear Coat. Sized 12" X 12"

UFGS: Section 09 30 10 Ceramic, Quarry, and Glass Tiling
<http://www.wbdg.org/FFC/DOD/UFGS/UFGS 09 30 10.pdf>



Type: **Style 2 Ceramic**

Applies to: Group 1 Group 2 Group 3 Group 4 Other

Mfr: Daltile

Color: Match existing.

Finish: Matte, slip resistant

Model #: Ceramic tile

Other: Use in low traffic area toilet rooms. Seal with Clear Coast. Size 2" X 2"

UFGS: Section 09 30 10 Ceramic, Quarry, and Glass Tiling
<http://www.wbdg.org/FFC/DOD/UFGS/UFGS 09 30 10.pdf>

E02.1.5. Resilient Floor

Applicable N/A

Number of base standards 1

Image Tool 250 x 188



Type: **Style 1 Stair Treads BCT/ LVT**

Applies to: Group 1 Group 2 Group 3 Group 4 Other

Mfr: Roppe

Color: Neutral tones

Finish: Factory

Model #: Raised design rubber tread

Other: Stair treads material

UFGS: Section 09 65 00 Resilient Flooring
<http://www.wbdg.org/FFC/DOD/UFGS/UFGS 09 65 00.pdf>

E02.1.6. Carpet

Applicable N/A

Number of base standards 2

Image Tool 250 x 188



Type: **Style 1**

Applies to: Group 1 Group 2 Group 3 Group 4 Other

Mfr: Mohawk Group

Color: Neutral multi-colored tones/patterned/solid

Finish: Yarn: Nylon 6 or 6.6/cut pile or loop pile

Model #: Broadloom, 6' wide rolled, carpet tiles, entry walk-off carpet

Other: N/A

UFGS: UFGS 09 68 00 Carpeting

<http://www.wbdg.org/FFC/DOD/UFGS/UFGS 09 68 00.pdf>

Type: **Style 2**

Applies to: Group 1 Group 2 Group 3 Group 4 Other

Mfr: Mohawk Group

Color: Earth tones

Finish: Factory

Model #: Broadloom, residential loop, "Smartstrand"

Other: N/A

UFGS: UFGS 09 68 00 Carpeting

<http://www.wbdg.org/FFC/DOD/UFGS/UFGS 09 68 00.pdf>

E02.1.7. Rapidly-Renewable Products

Applicable N/A

E02.1.8. Other

Applicable N/A

Number of base standards 1

Image Tool 250 x 188



Type: **Epoxy Floor**

Applies to: Group 1 Group 2 Group 3 Group 4 Other

Mfr: TBD

Color: Approved by BCE

Finish: Epoxy

Model #: TBD

Other: Based upon building function; floor may need to be chemical or fuel resistant or food grade.

UFGS: UFGS 09 67 23.13 Standard Resinous Flooring
<https://www.wbdg.org/FFC/DOD/UFGS/UFGS%2009%2067%2023.13.pdf>

E03. Walls

Comply with Air Force Corporate Standards for Walls:
<http://afcs.wbdg.org/facilities-interiors/walls/index.html>

E03.1. Wall Materials

Facility Group 1 wall materials shall be as follows.

Primary: Gypsum board (painted)
Secondary: Brick or Concrete (as approved by the BCE)
Tertiary: Ceramic tile (restrooms)

Facility Group 2 wall materials shall be as follows.

Primary: Gypsum board (painted)
Secondary: Brick or Concrete (as approved by BCE)
Tertiary: Ceramic tile (restrooms)

Facility Group 3 wall materials shall be as follows.

Primary: Ground face block, sealed (do not paint)
Secondary: Gypsum board (painted)
Tertiary: Ceramic tile (restrooms)

Facility Group 4 wall materials shall be as follows.

Primary: Gypsum board (painted)
Secondary: N/A
Tertiary: Ceramic tile (restrooms)

1. Follow UFC 3-450-01 (Vibration and Noise Control) for acoustic design issues including speech privacy, sound isolation or sound masking.
2. Select and apply paint with sheens (gloss levels) appropriate for the application following UFGS Section 09 90 00 Paints and Coatings.

Keesler AFB Standard Base Colors
SW6238 Icicle Semi Gloss
SW6239 Upward Semi Gloss
SW6240 Windy Blue Semi Gloss
SW6241 Aleutian Semi Gloss
27778 Parchment Semi Gloss
27880 Dover White Semi Gloss
23617 Dublin Tan Semi Gloss
37769 Cream Flat
27925 White Exterior Semi Gloss
Battleship Gray Floor Paint
Youth Center Bronze Gloss
Youth Center Bronze Semi Gloss
Youth Center Bronze Flat

3. Provide ceramic tile on wet walls of kitchens, toilet rooms, locker rooms, etc., in all facility groups.
4. Neutral split-face or ground-face integrally colored block with a clear sealer may be used in Group 3.
5. Provide rubber base on all partitions in Groups 1, 2 and 3, except for those partitions with tile.
6. Hardwood base may only be used in Group 1 as approved on a case by case basis.
7. Hardwood chair rails/ bumper rails may be used in high-use areas of Groups 1 and 2; aqueous clear finishes are preferred to reduce maintenance; plastic chair rails are permitted only in medical applications and food preparation areas.
8. Decorative moldings may be used only in Group 1 when approved on a case by case basis.
9. Corner guards are permitted only in high traffic spaces with wheeled or cart use such as private service areas in Groups 1 and 2; stainless steel corners guards with a brushed finish may be judiciously used in Group 3.
10. Group 4 may use painted composite wood base.
11. Manufacturers listed below are only provided to establish a baseline of equivalency among all applicable manufacturers.

Note: *Apply the below base-wide standards for Walls (products, materials and color). Then refer to the Appendix and apply any additional requirements specifically related to the Facility District in which the project is located.*

E03.1.1. Concrete

Applicable N/A

Number of base standards 1

Image Tool 250 x 188



Type: **Cast In Place or Precast Concrete**

Applies to: Group 1 Group 2 Group 3 Group 4 Other

Mfr: TBD

Color: Natural

Finish: Smooth

Model #: TBD

Other: N/A

UFGS: Section 04 20 00 Unit Masonry

<http://www.wbdg.org/FFC/DOD/UFGS/UFGS 04 20 00.pdf>

E03.1.2. Masonry

Applicable N/A

Number of base standards 2

Image Tool 250 x 188



Type: **Brick**

Applies to: Group 1 Group 2 Group 3 Group 4 Other

Mfr: Boral

Color: #524 Dark Gray Bartex

Finish: Light texture

Model #: Coursed unit masonry

Other: Brick is preferred. Concrete block may only be used in Group 3 when approved by the BCE.

UFGS: Section 03 33 00 Cast-In-Place Architectural Concrete

<http://www.wbdg.org/FFC/DOD/UFGS/UFGS 03 33 00.pdf>

Type: **Concrete Block**



Applies to: Group 1 Group 2 Group 3 Group 4 Other

Mfr: TBD

Color: Approved by BCE

Finish: Painted or Natural

Model #: TBD

Other:

UFGS: Section 03 33 00 Cast-In-Place Architectural Concrete
<http://www.wbdg.org/FFC/DOD/UFGS/UFGS 03 33 00.pdf>

E03.1.3. Ceramic Tile

Applicable N/A

Number of base standards 1

Image Tool 250 x 188

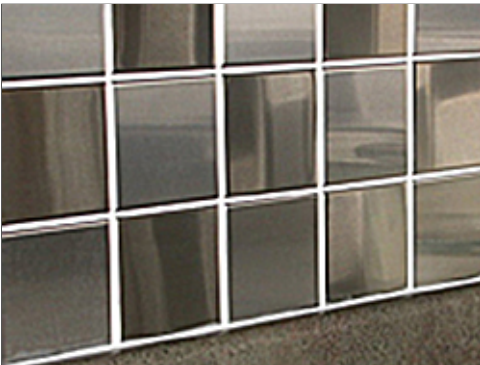

Type: **Style 1**

Applies to: Group 1 Group 2 Group 3 Group 4 Other

Mfr: Daltile

Color: Earth tones

Finish: Gloss, Semi-gloss; Glazed, Semi-glazed

Model #: Ceramic wall tile

Other: Located on wet walls in restrooms and wet areas. Sizes 2" x 2" in restrooms.

UFGS: Section 09 30 10 Ceramic, Quarry, and Glass Tiling
<http://www.wbdg.org/FFC/DOD/UFGS/UFGS 09 30 10.pdf>

E03.1.4. Gypsum Board

Applicable N/A

Number of base standards 2

Image Tool 250 x 188



Type: **Regular Type X for Fire Rated Walls**

Applies to: Group 1 Group 2 Group 3 Group 4 Other

Mfr: US Gypsum

Color: Solid Earth tone colors

Finish: Paint (Sheen per UFGS)

Model #: Tapered edge

Other: N/A

UFGS: Section 09 29 00 Gypsum Board

<http://www.wbdg.org/FFC/DOD/UFGS/UFGS 09 29 00.pdf>

Section 09 90 00 Paints and Coatings

<http://www.wbdg.org/FFC/DOD/UFGS/UFGS 09 90 00.pdf>

Type: **Type MR (Moisture Resistant) for Wet Walls**

Applies to: Group 1 Group 2 Group 3 Group 4 Other

Mfr: US Gypsum

Color: TBD

Finish: Paint (Sheen per UFGS)

Model #: Tapered Edge

Other: N/A

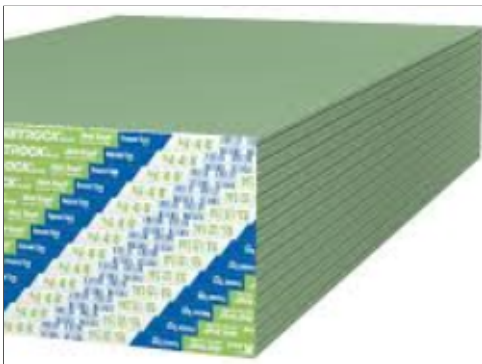

UFGS: Section 09 29 00 Gypsum Board

<http://www.wbdg.org/FFC/DOD/UFGS/UFGS 09 29 00.pdf>

Section 09 90 00 Paints and Coatings

<http://www.wbdg.org/FFC/DOD/UFGS/UFGS 09 90 00.pdf>

E03.1.5. Metal Panels

Applicable N/A

E03.1.6. Wood Paneling

Applicable N/A

Number of base standards 1

Image Tool 250 x 188



Type: **Wainscoting**

Applies to: Group 1 Group 2 Group 3 Group 4 Other

Mfr: TBD

Color: TBD

Finish: Painted or Stained

Model #: TBD

Other: BCE Approval Required. Can be used in Command Meeting Rooms.

UFGS: Section 06 26 00 Board Paneling
(Not Available on UFGS)

E03.1.7. Rapidly-Renewable Products

Applicable N/A

E03.1.8. Other

Applicable N/A

E04. Ceilings

Comply with Air Force Corporate Standards for Ceilings:
<http://afcs.wbdg.org/facilities-interiors/ceilings/index.html>

E04.1. Ceiling Materials

Facility Group 1 ceiling materials shall be as follows.

Primary: Grid and Acoustical Tile
Secondary: Gypsum and Acoustical Tile
Tertiary: N/A

Facility Group 2 ceiling materials shall be as follows.

Primary: Grid and Acoustical Tile
Secondary: Gypsum board (painted)
Tertiary: N/A

Facility Group 3 ceiling materials shall be as follows.

Primary: Exposed Framing (Roof / Floor Structure Above)
Secondary: Gypsum board (painted)
Tertiary: N/A

Facility Group 4 ceiling materials shall be as follows.

Primary: Gypsum board (painted)
Secondary: Grid and Acoustical tile
Tertiary: N/A

1. Accent ceiling materials such as metal, wood, and rapidly renewable may be used in Group 1 as approved on a case basis.
2. Follow UFC 3-450-01 (Vibration and Noise Control) for acoustic design issues including speech privacy, sound isolation or sound masking.
3. Manufacturers listed below are only provided to establish a baseline of equivalency among all applicable manufacturers.

Note: Apply the below *base-wide standards for Ceilings (products, materials and color)*. Then refer to the Appendix and apply any additional requirements specifically related to the Facility District in which the project is located.

E04.1.1. Exposed Framing (Roof / Floor Structure Above)

Applicable N/A Number of base standards 1

Image Tool 250 x 188



Type: **Style 1**

Applies to: Group 1 Group 2 Group 3 Group 4 Other

Mfr: Vulcraft

Color: Neutral colors reviewed on a case by case basis

Finish: Field painted (Sheen per UFGS)

Model #: Formlok floor and roof decking

Other: N/A

UFGS: Section 05 30 00 Steel Decks
<http://www.wbdg.org/FFC/DOD/UFGS/UFGS 05 30 00.pdf>

E04.1.2. Exposed Concrete

Applicable N/A

Number of base standards 1

Image Tool 250 x 188



Type: **Exposed Floor or Roof Structure**

Applies to: Group 1 Group 2 Group 3 Group 4 Other

Mfr: Local

Color: TBD

Finish: TBD

Model #: N/A

Other: N/A

UFGS: Section 03 33 00 Cast-In-Place Architectural Concrete
<http://www.wbdg.org/FFC/DOD/UFGS/UFGS 03 33 00.pdf>

E04.1.3. Grid and Acoustical Tile

Applicable N/A

Number of base standards 1

Image Tool 250 x 188



Type: **Style 1**

Applies to: Group 1 Group 2 Group 3 Group 4 Other

Mfr: Armstrong

Color: White

Finish: Factory

Model #: 2'x2' Fine Fissure or Dune

Other: Performance characteristics are Class A; NRC-0.70; CAC-40; LR-0.86; minimum recycled content 82%.

UFGS: Section 09 51 00 Acoustical Ceilings
<http://www.wbdg.org/FFC/DOD/UFGS/UFGS 09 51 00.pdf>

E04.1.4. Gypsum Board

Applicable N/A

Number of base standards 1

Image Tool 250 x 188

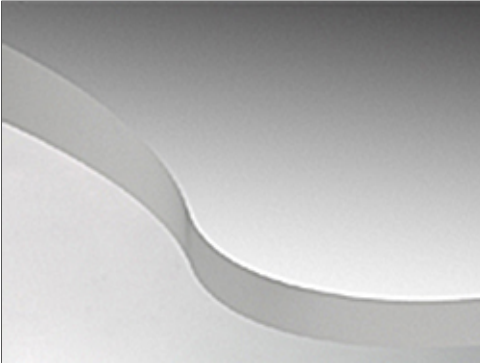

Type: **Style 1**

Applies to: Group 1 Group 2 Group 3 Group 4 Other

Mfr: US Gypsum

Color: Solid neutral colors

Finish: Paint (sheen per UFGS)

Model #: N/A

Other: N/A

UFGS: Section 09 29 00 Gypsum Board

<http://www.wbdg.org/FFC/DOD/UFGS/UFGS 09 29 00.pdf>

Section 09 90 00 Paints and Coatings

<http://www.wbdg.org/FFC/DOD/UFGS/UFGS 09 90 00.pdf>

E04.1.5. Metal Panels

Applicable N/A

E04.1.6. Wood

Applicable N/A

E04.1.7. Rapidly-Renewable Products

Applicable N/A

E04.1.8. Other

Applicable N/A

E05. Doors and Windows

Comply with Air Force Corporate Standards for Doors and Windows:

<http://afcf.wbdg.org/facilities-interiors/doors-and-windows/index.html>

E05.1. Doors and Windows and Frames Materials

Facility Group 1

door (frame) and window frame materials shall be as follows.

Primary: Hollow metal (painted)

Secondary: Aluminum, Bronze anodized

Tertiary: N/A

Facility Group 1

door (leaf) materials shall be as follows.

Primary: Hardwood veneer

Secondary: Hollow metal (painted)

Tertiary: N/A

Facility Group 2

door (frame) and window frame materials shall be as follows.

Primary: Hollow metal (painted)

Secondary: Aluminum, bronze anodized

Tertiary: N/A

Facility Group 2

door (leaf) materials shall be as follows.

Primary: Hardwood veneer

Secondary: Hollow metal (painted)

Tertiary: N/A

Facility Group 3

door (frame) and window frame materials shall be as follows.

Primary: Hollow metal (galvanized, painted)

Secondary: Hollow metal (not galvanized, painted)

Tertiary: N/A

Facility Group 3

door (leaf) materials shall be as follows.

Primary: Hollow metal (galvanized, painted)

Secondary: Hollow metal (galvanized, painted)

Tertiary: Hardwood veneer

Facility Group 4

door (frame) and window frame materials shall be as follows.

Primary: Wood

Secondary: N/A

Tertiary: N/A

Facility Group 4

door (leaf) materials shall be as follows.

Primary: Wood solid core

Secondary: Composite solid core

Tertiary: N/A

1. Hardwood casings may be provided over metal frames in Group 1 as approved on a case basis.
2. Paneled textured doors are preferred in Group 4.
3. Do not use hollow-core wood doors.
4. Generally match original hardware in renovations.
5. Manufacturers listed below are only provided to establish a baseline of equivalency among all applicable manufacturers.

Note: Apply the below *base-wide standards* for Doors and Windows (products, materials and color). Then refer to the Appendix and apply any additional requirements specifically related to the Facility District in which the project is located.

E05.1.1. Aluminum

Applicable N/A

Number of base standards 1

Image Tool 250 x 188



Type: **Style 1**

Applies to: Group 1 Group 2 Group 3 Group 4 Other

Mfr: Kawneer, Coral, YKK

Color: Bronze anodized

Finish: Factory

Model #: InFrame Interior Framing, (2x4 nominal framing)

Other: Satin stainless steel hardware

UFGS: Section 08 41 13 Aluminum-Framed Entrances and Storefronts
<http://www.wbdg.org/FFC/DOD/UFGS/UFGS 08 41 13.pdf>
Section 08 71 00 Door Hardware
<https://www.wbdg.org/FFC/DOD/UFGS/UFGS 08 71 00.pdf>

E05.1.2. Hollow Metal

Applicable N/A

Number of base standards 2

Image Tool 250 x 188



Type: **Steel Doors**

Applies to: Group 1 Group 2 Group 3 Group 4 Other

Mfr: Steelcraft

Color: TBD

Finish: Paint (Sheen per UFGS)

Model #: Hollow metal, 2" w. frames, 16 gauge (welded corners) grouted solid

Other: Provide in Group 3 and in utility areas of Group 1 and 2. Provide A25 "galvannealed" coating. All interior steel doors shall have a factory applied primer finish. Provide satin stainless steel hardware.

UFGS: Section 08 11 13 Steel Doors and Frames
<http://www.wbdg.org/FFC/DOD/UFGS/UFGS 08 11 13.pdf>
Section 08 71 00 Door Hardware
<https://www.wbdg.org/FFC/DOD/UFGS/UFGS 08 71 00.pdf>

Type: **Steel Frames**

Applies to: Group 1 Group 2 Group 3 Group 4 Other

Mfr: Steelcraft

Color: TBD

Finish: Paint (Sheen per UFGS)

Model #: Hollow metal, frame grouted solid

Other: Satin stainless steel hardware

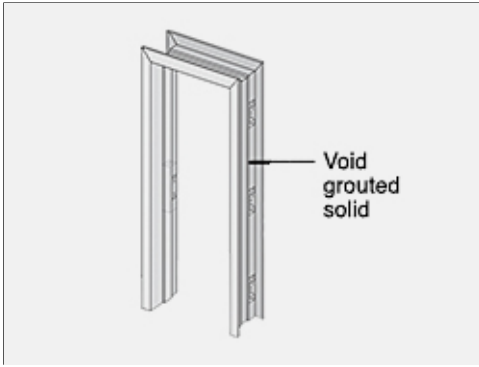

UFGS: Section 08 11 13 Steel Doors and Frames

<http://www.wbdg.org/FFC/DOD/UFGS/UFGS 08 11 13.pdf>

Section 08 71 00 Door Hardware

<https://www.wbdg.org/FFC/DOD/UFGS/UFGS 08 71 00.pdf>

E05.1.3. Wood

Applicable N/A

Number of base standards 2

Image Tool 250 x 188

Type: **Style 1, Administrative**

Applies to: Group 1 Group 2 Group 3 Group 4 Other

Mfr: Simpson

Color: Natural hardwood veneer

Finish: Clear Sealer, satin (aqueous)

Model #: 3'x7'x 1 3/4", solid core

Other: Satin stainless steel hardware, Glass lites may be used. Stained birch veneer face, 5 ply construction, rotary cut finish.



UFGS: Section 08 14 00 Wood Doors

<http://www.wbdg.org/FFC/DOD/UFGS/UFGS 08 14 00.pdf>

Section 08 71 00 Door Hardware

<https://www.wbdg.org/FFC/DOD/UFGS/UFGS 08 71 00.pdf>

Type: **Style 2, Residential**

Applies to: Group 1 Group 2 Group 3 Group 4 Other

Mfr: Simpson

Color: Natural hardwood veneer or paint grade

Finish: Clear Sealer or paint, satin (aqueous)

Model #: Full slab or panels

Other: Satin nickel hardware

UFGS: Section 08 14 00 Wood Doors
<http://www.wbdg.org/FFC/DOD/UFGS/UFGS 08 14 00.pdf>
Section 08 71 00 Door Hardware
<https://www.wbdg.org/FFC/DOD/UFGS/UFGS 08 71 00.pdf>

E05.1.4. Other

Applicable N/A

E06. Casework Systems

Comply with Air Force Corporate Standards for Casework Systems:
<http://afcs.wbdg.org/facilities-interiors/casework-systems/index.html>

E06.1. Casework Materials

1. Select casework systems and materials considering durability, maintenance requirements and LCCA.
2. Natural stone and cast stone countertops may only be used in Group 1 with approval on a case basis.
3. Metal cabinets and countertops shall be provided in heavy-use operations and in Group 3.
4. Refer to AFCFS for approved materials.
5. Manufacturers listed below are only provided to establish a baseline of equivalency among all applicable manufacturers.

E06.1.1. Plastic Laminate

Applicable N/A

Number of base standards 1

Image Tool 250 x 188



Type: **Style 1, Low Use Areas**

Applies to: Group 1 Group 2 Group 3 Group 4 Other

Mfr: Formica

Color: Medium Earth tones and neutral tones

Finish: Pre-form bull nose edge with no texture

Model #: High pressure laminate

Other: Combine with matching solid-surface banding on casework edges.

UFGS: Section 06 41 16.00 10 Plastic-Laminate-Clad Architectural Cabinets
http://www.wbdg.org/FFC/DOD/UFGS/UFGS_06_41_16.00_10.pdf

E06.1.2. Solid Polymer Surface

Applicable N/A

Number of base standards 1

Image Tool 250 x 188



Type: **Style 1, High Use Areas**

Applies to: Group 1 Group 2 Group 3 Group 4 Other

Mfr: Corian

Color: Medium Earth tones and neutral tones

Finish: no texture

Model #: Solid Surface

Other: Faces and edge banding

UFGS: Section 12 36 00 Countertops
http://www.wbdg.org/FFC/DOD/UFGS/UFGS_12_36_00.pdf

E06.1.3. Rapidly-Renewable Products

Applicable N/A

E06.1.4. Metal

Applicable N/A

Number of base standards 1

Image Tool 250 x 188



Type: **Style 1**

Applies to: Group 1 Group 2 Group 3 Group 4 Other

Mfr: Steel Sentry

Color: Natural stainless steel or neural colors (steel)

Finish: Mill (stainless) or Powder coated (steel)

Model #: Lab, workbench, computer workstation

Other: Provide highly durable fabrications and finishes in Group 3 which are subjected to heavy use.

UFGS: Section 12 31 00 Manufactured Metal Casework
<http://www.wbdg.org/FFC/DOD/UFGS/UFGS 12 31 00.pdf>

E06.2. Countertop Materials

E06.2.1. Plastic Laminate

Applicable N/A

Number of base standards 1

Image Tool 250 x 188



Type: **Style 1, Low Use Areas**

Applies to: Group 1 Group 2 Group 3 Group 4 Other

Mfr: Formica

Color: Medium Earth tones and neutral tones

Finish: Pre-form bull nose edge with no texture

Model #: High pressure laminate

Other: Only use rounded half or full bullnose and integral backsplash. Do not use plastic laminate edge banding on front edges.

UFGS: Section 06 41 16.00 10 Plastic-Laminate-Clad Architectural Cabinets
<http://www.wbdg.org/FFC/DOD/UFGS/UFGS 06 41 16.00 10.pdf>

E06.2.2. Solid Polymer Surface

Applicable N/A

Number of base standards 1

Image Tool 250 x 188



Type: **Style 1, High Use Areas**

Applies to: Group 1 Group 2 Group 3 Group 4 Other

Mfr: Corian

Color: Medium Earth tones and neutral tones

Finish: no textured

Model #: Solid Surface

Other: Faces and edges banding

UFGS: Section 12 36 00 Countertops

[http://www.wbdg.org/FFC/DOD/UFGS/UFGS 12 36 00.pdf](http://www.wbdg.org/FFC/DOD/UFGS/UFGS_12_36_00.pdf)

E06.2.3. Natural Stone

Applicable N/A

E06.2.4. Cast Stone

Applicable N/A

E06.2.5. Metal

Applicable N/A

Number of base standards 1

Image Tool 250 x 188

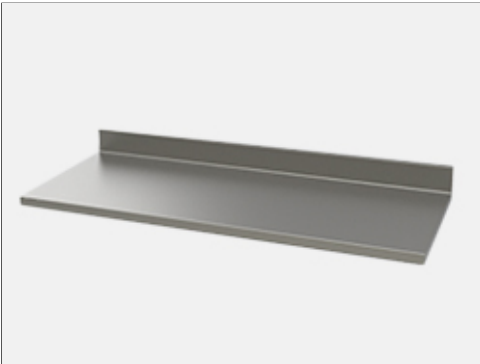

Type: _____

Applies to: Group 1 Group 2 Group 3 Group 4 Other

Mfr: Local (TBD)

Color: Natural stainless steel

Finish: Mill

Model #: Custom fabricated countertops

Other: Provide integral fronts, sides and backsplash

UFGS: Section 12 31 00 Manufactured Metal Casework
[http://www.wbdg.org/FFC/DOD/UFGS/UFGS 12 31 00.pdf](http://www.wbdg.org/FFC/DOD/UFGS/UFGS%2012%2031%2000.pdf)

E07. Furnishings

Comply with Air Force Corporate Standards for Furnishings:
<http://afcs.wbdg.org/facilities-interiors/furnishings/index.html>

E07.1. Durability and Serviceability

Comply with AF Corporate Standards for Durability and Serviceability:
<http://afcs.wbdg.org/facilities-interiors/furnishings/durability-and-serviceability/index.html>

E07.2. Accessories

Comply with AF Corporate Standards for Accessories:
<http://afcs.wbdg.org/facilities-interiors/furnishings/accessories/index.html>

E08. Interior Signs

Comply with Air Force Corporate Standards for Interior Signs:
<http://afcs.wbdg.org/facilities-interiors/interior-signs/index.html>

E08.1 Types and Color

Comply with Air Force Corporate Standards for Types and Color:
<http://afcs.wbdg.org/facilities-interiors/interior-signs/types-and-color/index.html>

E08.2. Interior Signs Materials

1. Natural stone, masonry and cast stone signs may only be used in Group 1 with approval on a case by case basis.

E09. Lighting, Power and Communication

E09.1. Functionality and Efficiency

Comply with Air Force Corporate Standards for Functionality and Efficiency:

<http://afcfs.wbdg.org/facilities-interiors/lighting-power-and-communication/functionality-and-efficiency/index.html>

E09.2. Types and Color

In addition to the the UFC regarding communications, the following guidance should also be followed:

1. Instruction OSHA CFR 29 Part 1910-268 - Telecommunications
2. RUS Bulletin 1751F-643 - Underground Plant Design
3. RUS Bulletin 1751F-644 - Underground Plant Construction Telecommunications
4. Engineering Shield Continuity and Construction Manual (TE&CM) 451.2
5. RUS Bulletin 1751F-801 - Electrical Protection Fundamentals
6. RUS Bulletin 1753F-151 (515b) - Specifications and Drawings for Underground Cable
7. FGDC-STD-007.3-1998 - Geospatial Positioning Accuracy Standards Part 3: National Standard for Spatial Data Accuracy

F. APPENDIX - Facility Districts

- Applicable
- N/A

G. APPENDIX - References

Comply with Air Force Corporate Standards:
<http://afcs.wbdg.org/index.html>