

JOINT BASE MCGUIRE-DIX-LAKEHURST INSTALLATION FACILITIES STANDARDS (IFS) VOL. 1: JBMDL MCGUIRE



Installation Elements



Site Development



Facilities Exteriors



Facilities Interiors

APPROVED FOR PUBLIC RELEASE; DISTRIBUTION UNLIMITED

Signature Field

3 ARCHER.CHRISTOPHER.123041642 Digitally signed by
ARCHER.CHRISTOPHER.1230416423
Date: 2019.02.01 16:33:23 -05'00'

Joint Base MDL McGuire IFS

Table of Contents

A. OVERVIEW	5	B03.2.3. Preserves	
A01. Facility Hierarchy	6	B03.2.4. Perimeter Fence	
A02. Facility Quality	6	C. SITE DEVELOPMENT	26
A03. Facility Districts	6	C01. Site Design	26
B. INSTALLATION ELEMENTS	8	C01.1. Site Design Considerations	26
B01. Comprehensive Planning	8	C01.2. Building Orientation	27
B01.1. Installation Development Plan (IDP)	8	C02. Utilities	28
B01.1.1. IFS Component Plan of IDP		C02.1. Utility Components.....	28
B01.1.2. Brief History of Base		C03. Parking Areas	29
B01.1.3. Future Development		C03.1. Configurations and Design	30
B02. Street Envelope Standards	11	C03.1.1. Paving and Striping	
B02.1. Hierarchy of Streets	11	C03.1.2. Curbing	
B02.1.1. Arterial Streets		C03.1.3. Internal Islands and Medians	
B02.1.2. Collector Streets		C03.2. Parking Structures	33
B02.1.3. Local Streets		C03.3. Connectivity	33
B02.1.4. Special Routes		C04. Stormwater Management	33
B02.2. Hierarchy of Intersections	15	C04.1. Stormwater Requirements	34
B02.2.1. Arterials		C05. Sidewalks, Bikeways and Trails	35
B02.2.2. Arterial/Collector		C05.1. Circulation and Paving	35
B02.2.3. Collectors		C05.1.1. Ramps and Stairs	
B02.2.4. Special Intersections		C05.1.2. Lighting	
B02.2.5. Street Frontage Requirements		C06. Landscape	37
B02.2.6. Sight Lines		C06.1. Climate-based Materials	38
B02.3. Street Elements	17	C06.1.1. Landscape Design Concept	
B02.3.1. Paving		C06.1.2. Xeriscape Design Principles	
B02.3.2. Curb and Gutter		C06.1.3. Minimizing Water Requirements	
B02.3.3. Utility Service Elements		C06.1.4. Plant Material Selection	
B02.3.4. Traffic Signs		C06.1.5. Water Budgeting (Hydrozones)	
B02.3.5. Street Lighting		C06.1.6. Base Entrance Landscaping	
B02.3.6. Other		C06.1.7. Streetscape Landscaping	
B03. Open Space / Public Space	19	C06.1.8. Pedestrian Circulation Landscaping	
B03.1. Plazas, Monuments and Static Displays	20	C06.1.9. Parking Lot Landscaping	
B03.1.1. Paved Plazas		C06.1.10. Screen/Accent Landscaping	
B03.1.2. Sculptures, Markers and Statuary		C06.1.11. Other	
B03.1.3. Static Display of Aircraft		C07. Site Furnishings	43
B03.2. Grounds and Perimeters	22	C07.1. Furnishings and Elements	44
B03.2.1. Parade Grounds			
B03.2.2. Parks			

Table of contents continued

C07.2. Site Furnishings Products, Materials / Color ..	45	D03.3.4. Thermal Shading	
C07.2.1. Barbeque Grills		D03.3.5. Renewable Heating/Cooling	
C07.2.2. Benches		D03.3.6. Solar Photovoltaic System	
C07.2.3. Bike Racks		D03.3.7. Solar Thermal System	
C07.2.4. Bike Lockers		D04. Building Entrances	79
C07.2.5. Bollards		D04.1. Primary Entrances	80
C07.2.6. Bus Shelters		D04.2. Secondary Entrances	80
C07.2.7. Drinking Fountains		D05. Wall Systems	81
C07.2.8. Dumpster Enclosures / Gates		D05.1. Hierarchy of Materials	82
C07.2.9. Fencing		D05.2. Layout, Organization and Durability	82
C07.2.10. Flagpoles		D05.3. Equipment, Vents and Devices	83
C07.2.11. Lighting – Landscape / Accent		D05.4 Wall Systems Materials	83
C07.2.12. Litter and Ash Receptacles		D05.4.1. Flat Metal Panels	
C07.2.13. Picnic Tables		D05.4.2. Brick Veneer	
C07.2.14. Planters – Free Standing		D05.4.3. Architectural Precast	
C07.2.15. Play Equipment		D05.4.4. Stucco Over Sheathing	
C07.2.16. Screen Walls		D05.4.5. Curtain Wall	
C07.2.17. Tree Grates		D05.4.6. Cast-in Place Concrete	
C07.2.18. Other		D05.4.7. Tilt-up Concrete	
C08. Exterior Signs	57	D05.4.8. Ribbed Metal Sheeting	
C08.1. Colors and Types	57	D05.4.9. EIFS	
C08.1.1. Materials and Color Specifications		D05.4.10.GFRC	
C08.1.2. Installation and Gate Identification Signs		D05.4.11.Concrete Block	
C08.1.3. Building Identification Signs		D05.4.12. Fiber Cement Siding	
C08.1.4. Traffic Control Devices (Street Signs)		D05.4.13. Other	
C08.1.5. Directional and Wayfinding Signs		D06. Doors and Windows	88
C08.1.6. Informational Signs		D06.1. Types	89
C08.1.7. Motivational Signs		D06.2. Layout and Geometry	89
C08.1.8. Parking Lot Signs		D06.3. Glazing and Shading	89
C08.1.9. Regulatory Signs		D06.4. Hardware	89
C08.1.10. Other		D06.5. Doors and Windows Materials	90
C09. Lighting	65	D06.5.1. Anodized Aluminum	
C09.1. Fixtures and Lamping	65	D06.5.2. Hollow Metal	
C09.2. Light Fixture Types	66	D06.5.3. Aluminum-clad Wood	
C09.2.1. Street Lighting		D06.5.4. Other	
C09.2.2. Parking Lot Lighting		D07. Roof Systems	92
C09.2.3. Lighted Bollards		D07.1. Roof Type and Form	93
C09.2.4. Sidewalk Lighting		D07.2. Roof Slope	94
C09.2.5. Walls / Stairs Lighting		D07.3. Parapets and Copings	94
C09.2.6. Other		D07.4. Color and Reflectivity	94
D. FACILITIES EXTERIORS	70	D07.5. Gutters, Downspouts, Scuppers, Drains	94
D01. Supporting the Mission	70	D07.6. Roof Vents and Elements	95
D02. Sustainability	70	D07.7. Clerestories and Skylights	95
D03. Architectural Features	71	D07.8. Vegetated Roof	95
D03.1. Orientation, Massing and Scale	72		
D03.2. Architectural Character	72		
D03.3. Details and Color	72		
D03.3.1. Climate-based Data			
D03.3.2. Natural Ventilation System			
D03.3.3. Thermal Mass			

Table of contents continued

D07.9. Roof Systems Materials	95	E04. Ceilings	118
D07.9.1. Standing Seam Metal		E04.1. Ceiling Materials	118
D07.9.2. Membrane Single-ply		E04.1.1. Exposed Framing (Roof / Floor Structure	
D07.9.3. Built-up Multi-ply		Above)	
D07.9.4. Concrete Tile		E04.1.2. Exposed Concrete	
D07.9.5. Clay Tile		E04.1.3. Grid and Acoustical Tile	
D07.9.6. Slate Shingles		E04.1.4. Gypsum Board	
D07.9.7. Vegetated System		E04.1.5. Metal Panels	
D07.9.8. Ribbed Metal Sheeting		E04.1.6. Wood	
D07.9.9. Composite Shingles		E04.1.7. Rapidly-Renewable Products	
D07.9.10. Other		E04.1.8. Other	
D08. Structural Systems	99	E05. Doors and Windows	121
D08.1. Systems and Layouts	100	E05.1. Doors and Windows and Frames Materials	121
D08.2. Structural Systems Materials	100	E05.1.1. Aluminum	
D08.2.1. Concrete		E05.1.2. Hollow Metal	
D08.2.2. Insulated Concrete Forming (ICF)		E05.1.3. Wood	
D08.2.3. Steel		E05.1.4. Other	
D08.2.4. Pre-Engineered Steel		E06. Casework Systems	125
D08.2.5. Masonry		E06.1. Casework Materials	125
D08.2.6. Heavy Timber		E06.1.1. Plastic Laminate	
D08.2.7. Light-gauge Steel		E06.1.2. Solid Polymer Surface	
D08.2.8. Lumber Framing		E06.1.3. Rapidly-Renewable Products	
D08.2.9. Other		E06.1.4. Metal	
D09. Mechanical, Electrical and Plumbing	103	E06.1.5 Other	
D09.1. Passive and Active Systems	104	E06.2. Countertop Materials	128
D09.2. Functionality and Efficiency	104	E06.2.1. Plastic Laminate	
E. FACILITIES INTERIORS	105	E06.2.2. Solid Polymer Surface	
E01. Building Configurations	106	E06.2.3. Natural Stone	
E01.1. Layout and Common Areas	106	E06.2.4. Cast Stone	
E01.1.1. Interior Design Process		E06.2.5. Metal	
E01.1.2. Codes and Regulations		E06.2.6 Other	
E01.2. Quality and Comfort	107	E07. Furnishings	130
E02. Floors	108	E07.1. Durability and Serviceability	130
E02.1. Floor Materials	108	E07.2. Accessories	130
E02.1.1. Prepared Slabs		E08. Interior Signs	130
E02.1.2. Natural Stone and Terrazzo		E08.1 Types and Color	130
E02.1.3. Quarry Tile		E08.2. Interior Signs Materials	131
E02.1.4. Ceramic Tile		E09. Lighting, Power and Communication	131
E02.1.5. Resilient Floor		E09.1. Functionality and Efficiency	131
E02.1.6. Carpet		E09.2. Types and Color	131
E02.1.7. Rapidly-Renewable Products		F. Appendices	132
E02.1.8. Other		G. Appendices	132
E03. Walls	115		
E03.1. Wall Materials	115		
E03.1.1. Concrete			
E03.1.2. Masonry			
E03.1.3. Ceramic Tile			
E03.1.4. Gypsum Board			
E03.1.5. Metal Panels			
E03.1.6. Wood Paneling			
E03.1.7. Rapidly-Renewable Products			
E03.1.8. Other			

A. OVERVIEW

Comply with Air Force Corporate Standards for Overview:

<http://afcfs.wbdg.org/index.html>

This Installation Facilities Standards (IFS) document is part of the Air Force Corporate Facilities Standards (AFCFS) program to assist bases in implementing and maintaining facilities standards as appropriate for efficient operations within the respective climate region. IFS fully replaces, consolidates and simplifies existing facilities standards documents, such as the Architectural Compatibility Plan (ACP) or ACGs, FEPs, etc., and organizes information using the same structure, or Table of Contents, as the AFCFS website.

IFS reflects the AFCFS' concepts of "Facility Hierarchy" (categorizing facilities into group numbers) and "Facility Quality" (assigning an appropriate level of quality to each group number) and applies these principles at the base level. Applicable DoD and Air Force criteria such as UFCs, AFIs, Memoranda, and UFGSs (Guide Specs) are referenced and linked within IFS to ensure the document is always current.

Navigating within this IFS is efficient and straightforward. Please use the interactive Table of Contents to locate subject matter, and click on the title of a section to access it. From any page, click on the "Back to Table of Contents" footer to return. Content is organized into 4 major sections: Installation Elements, Site Development, Facilities Exteriors and Facilities Interiors.

This IFS document begins as a fill-in PDF form, which is fully editable, and becomes a "living document" that can be regularly updated by base-level personnel following a format that is consistent across the Air Force. While the format is standardized, IFS content is customized for base operations and the local climate to ensure mission success while emphasizing reduced maintenance and reduced initial costs, life-cycle costs, energy use, and water use.

1. Conformance to Air Force Corporate Facilities Standards (AFCFS) and Installation Facilities Standards (IFS) are required by Air Force Instruction (AFI) 32-1023 and Air Force Memorandum. Please refer to the AFCFS website for links to documentation on current policy.
2. Requests to deviate from any installation facilities standards, that are Unified Facilities Criteria (UFC) requirements, will follow the process outlined in the AFCFS for UFC waivers and exemptions.
3. The IFS is a component plan of the Installation Development Plan (IDP) per Air Force Instruction (AFI) 32-7062 (replacing the Architectural Compatibility Plan). All military construction projects and Non-Appropriated Funds (NAF) facilities are required to comply with the IDP and its IFS component plan by AFI 32-1023. The Base Civil Engineer (BCE) maintains and implements the IDP and its component plans, to include the IFS.
4. Please refer to the AFCFS website as a portal to reference materials and requirements documents for design and construction projects (via links). Specific references to current DoD memoranda and Air Force criteria are updated periodically to provide the most current guidance and requirements. Programming, design and contract documents should list "current edition" for all reference and requirements documents. The documents in force at the date of execution of the design and/or construction contract shall be the governing version.
5. *Advanced Modeling Requirements:*
For all Air Force projects requiring advanced modeling, to include 3D visualization, Building Information Modeling (BIM), facility data, quantity take-off, geospatial, etc., follow the Army standards. Refer to USACE Minimum Model Matrix (M3) and Project Execution Plan (PxP) which outline required model uses. Refer to [CAD BIM Technology Center \(Contract Requirements\)](#) for more information on M3 and PxP.
6. Joint Bases shall implement IFS under their Joint-Base designation with volume numbers for individual installations following the IFS Development Tool template. For example, for Joint Base Langley-Eustis, provide: Vol. 1 Langley AFB and Vol. 2 Fort Eustis.
7. References and Supplementary Documents listed in Appendix G are included in these Installation Facilities Standards by reference and are fully part of this document. Please refer to [Appendix G](#) for a listing of documents, which are available via hyperlink for viewing and downloading.

Applicable N/A Large graphics

Applicable N/A Small graphics

A01. FACILITY HIERARCHY

Comply with AF Corporate Standards for Facility Hierarchy (and subsections):
<http://afcfs.wbdg.org/facility-hierarchy/index.html>

A02. FACILITY QUALITY

Comply with AF Corporate Standards for Facility Quality (and subsections):
<http://afcfs.wbdg.org/facility-quality/index.html>

A03. FACILITY DISTRICTS

Comply with AF Corporate Standards for Facility Districts (and subsections):
<http://afcfs.wbdg.org/facility-districts/index.html>

JBMDL MCGUIRE FACILITY DISTRICTS MAP

LEGEND

- 1 Academic Training
- 2 Aviation Industrial Complex
- 3 Field / Simulator Training
- 4 Joint Base Industrial Support
- 5 Joint Base Support
- 6 Medical
- 7 Military Family Housing
- 8 Mobilization Training
- 9 The Quad
- 10 Research Campus
- 11 Testing and Training
- 12 Town Center and Joint Base Administration

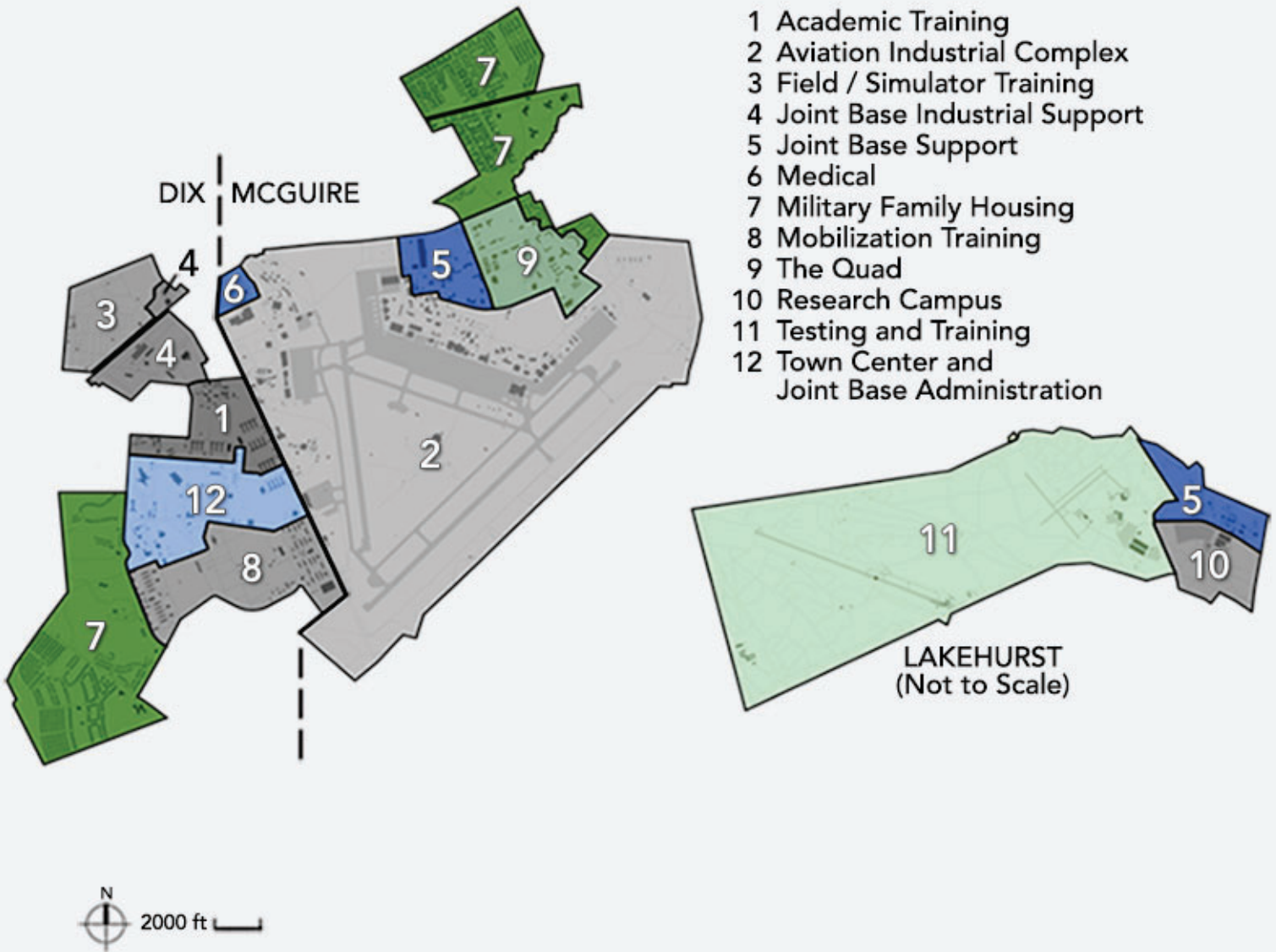

Note: Apply the base-wide standards in this IFS for Installation Elements, Site Development, Facilities Exteriors and Facilities Interiors (products, materials, color, etc.). Following application of the base-wide standards, refer to the Appendix and apply any additional requirements specifically related to the Facility District.

B. INSTALLATION ELEMENTS

Comply with Air Force Corporate Standards for Installation Elements:
<http://afcs.wbdg.org/installation-elements/index.html>

B01. COMPREHENSIVE PLANNING

Comply with Air Force Corporate Standards for Comprehensive Planning:
<http://afcs.wbdg.org/installation-elements/comprehensive-planning/index.html>

B01.1. Installation Development Plan (IDP)

Applicable N/A Large graphics

Applicable N/A Small graphics

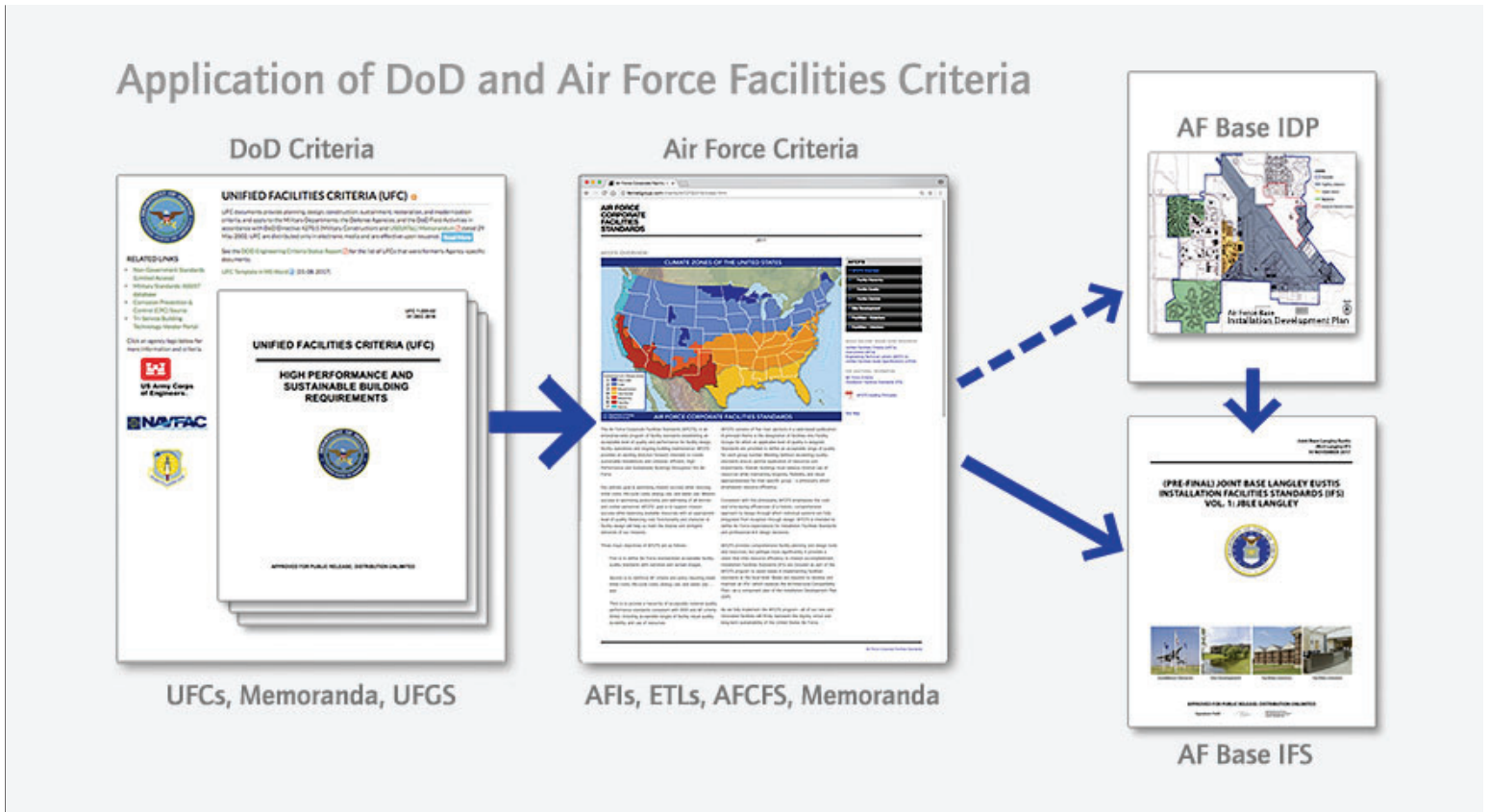

Department of Defense, Department of the Air Force and Air Force Base Criteria

1. JBMDL McGuire, while maintaining its own identity, shall support and increase mission effectiveness in supporting its designation as Joint Base McGuire-Dix-Lakehurst.
2. The base is required to provide and maintain Installation Facilities Standards (IFS) as a Component Plan of the base's Installation Development Plan (IDP).
3. Maintain existing districts following UFC 2-100-01 Installation Master Planning. New districts may be established based upon geographic features, land use patterns, building types, and/or transportation networks following the UFC under the base's master planning process.
4. New construction and renovations shall follow the base-wide standards for facility group number established by this IFS unless there are exceptions established within a particular district. Please refer to Appendix F, which outlines exceptions, if any, to the base-wide standards for each district.

B01.1.1. IFS Component Plan of IDP

Applicable N/A Large graphics

Applicable N/A Small graphics

1. Maintain this Installation Facilities Standards (IFS) as a Component Plan of the base's Installation Development Plan (IDP).

B01.1.2. Brief History of Base

Applicable N/A Large graphics

Applicable N/A Small graphics



Early Aircraft Near Atlantic Coast



Maj. Thomas B. McGuire Jr., Center



Fighter Aircraft Near McGuire AFB, c. 2000

Joint Base McGuire-Dix-Lakehurst located in central New Jersey State, was first established in 1916, and was not a contiguous military installation. Camp Dix was established in 16 July 1917 serving as a training and staging ground for units during World War I (WWI), collaborating with the New York Port of Embarkation providing logistics for troops and supplies. In the interim of the World Wars, Camp Dix was a reception, training and discharge center for the Civilian Conservation Corps. During the Roosevelt Administration, the Army Air Forces expanded their mission and acquired new land to prepare for another possible world war; Camp Dix was now identified as Fort Dix Army Air Base. In 1945, the Fort Dix Army Air Base (now McGuire) portion of the base began phasing down operational missions following the war and was officially designated as Inactive Status on 1 March 1946. On 15 July 1947, the remainder of Fort Dix became a basic training center, and rapidly expanded during the Vietnam War. Due to the 1988 Base Realignment and Closure, Fort Dix ended its active Army training mission. Fort Dix has since become a major center for the mobilization, training, deployment, and demobilization of reserve component forces.

The United States Air Force (USAF) Strategic Air Command (SAC) reactivated the base in 1948 implementing a modernization program to convert the World War II (WWII) base into an installation that supported postwar jet aircrafts. Support facilities were upgraded from temporary wooden structures to long-term permanent facilities. SAC appointed the 91st Strategic Reconnaissance Wing as the host unit to the newly established McGuire Air Force Base (MAFB); named after the late Maj. Thomas B. McGuire Jr. a Medal of Honor recipient and WWII flyer ace. Beginning in the early 1950's several different major commands were assigned to McGuire Air Force Base achieving multiple USAF missions and aptly coined the nickname "Gateway to the East" because the core mission became global mobility. USAF restructured and reorganized major commands, in 1992, assigning MAFB to the newly reorganized Air Mobility Command (AMC).

The Imperial Russian Army used Lakehurst Maxfield Field as a munitions testing site in 1916. In the midst of WWI, the United States Army (USA) acquired Lakehurst Maxfield Field and renamed the site to Camp Kendrick. The United States Navy (USN) purchased the property from the United States Army in 1921 to use as an airship station and renamed it Naval Air Station (NAS) Lakehurst after the nearby town of Lakehurst, New Jersey; the base was later renamed Naval Air Engineering Station Lakehurst (NAES Lakehurst). Since the 1930's the United States Navy has conducted the lighter-than-air program and was the epicenter of airship development. NAES Lakehurst is infamously known as the site for the 6 May 1937 LZ 129 Hindenburg disaster. During WWII, anti-submarine patrol blimps were operated from Lakehurst. Beginning in the 1950's, aviation boatswain's mates have been trained at Lakehurst to operate catapults and arresting systems on aircraft carriers. Lakehurst conducts the unique mission

of supporting and developing the Aircraft Launch and Recovery Equipment and Support Equipment for naval aviation. The Electromagnetic Aircraft Launch System (EMALS) and the Advanced Arresting Gear (AAG) system, which will replace the existing steam catapults and the MK-7 arresting gear, are being developed and tested at full-scale shipboard representative test facilities at Lakehurst.

Beginning in 2005, the Base Realignment and Closure Commission recommended consolidating McGuire Air Force Base, Fort Dix, and NAES Lakehurst, into a single joint base. Since all three installations performed common functions in support of base facilities and personnel, and shared common boundaries, there was “significant opportunity to reduce duplication of efforts with resulting reduction of overall manpower and facilities requirements capable of generating savings.” Furthermore, the Commission stressed that, “while acknowledging the importance of savings as a BRAC goal, the Commission went beyond a business model analysis of DoD’s recommendations and weighed the strategic environment within which recommendations would be implemented and their effect on DoD’s transformation goals.” Implementation of combining the three adjoining facilities follows in accordance to congressional legislation as prescribed in BRAC Commission Report to the President.

At joint bases, a lead Service or “supporting Service Component” is designated to manage the installation support on behalf of the joint base. Other Military Services at the joint base are known as the “supported Service Component(s)”. All installation support functions are transferred to the supporting Service Component along with the supported Service Component’s associated real property, funding, and equipment resources. The Air Force is the lead service, also known as the host Service Component, at Joint Base McGuire-Dix-Lakehurst.

On 1 October 2009, Joint Base McGuire-Dix-Lakehurst (JBMDL) became fully operational. The 87th Air Base Wing (ABW) was activated to provide installation management; personnel from all three services were incorporated into leadership roles.

JBMDL is the Department of Defense’s first tri-service base that consolidated Air Force, Army and Navy installations during a 2009 BRAC (Base Realignment and Closure) initiative.

B01.1.3. Future Development

Applicable N/A Large graphics

Applicable N/A Small graphics

1. Follow AFI 32-7062 for Air Force Comprehensive Planning, the Comprehensive Planning Process, Comprehensive Planning Requirements, and Geospatial Mapping.

2. Address all future development under the Installation Development Plan (IDP).

3. Integrate into future project development the following encroachment concerns outlined in the Installation Complex Encroachment Management Plan (ICEMAP):

- a. Airspace / Land Restrictions: JBMDL is located within the busiest airport corridor and any changes to capacity, approaches, and airspace potentially impact operations.
- b. Airspace / Land Restrictions: Growth within local civilian UAV traffic poses a flight safety risk and carries with it communication requirements between base and neighboring municipalities.
- c. Airspace / Land Restrictions: Hazardous Cargo Loading Area (HCLA) impacts operational functionality due to the nature of ordnance storage and shutting down Lima Taxiway.
- d. Airspace / Land Restrictions: Restricted Area R-5001A/B prevents pattern work to the east of McGuire Field. Due to the caliber of the ammunitions used during training activities the weapons danger zone (WDZs) heavy coordination is required between range and aviation activities.
- e. Safety / Security: The Bird / Wildlife Aircraft Strike Hazard (BASH) risk to habitat areas for state-listed bird species; operations are restricted during peak periods of migratory bird activity.

4. Consider current “Enhanced-Use Leasing” initiatives in new project development:

- a. SAF/IE selected Starwood Siemens as the Highest Ranked Offeror (HRO). JBMDL identified six (6) non-contiguous sites for energy leasing consideration.
- b. Technologies cited EULs include solar, biomass, waste-to-energy, combined cycle gas turbine (CCGT) and focus on energy security.

5. Integrate the following “Energy Assurance” initiatives:

- a. 2017 Phase I Energy Assurance Master plan; Phase II targeted for contract award in FY 17.

- b. SAF/IE Office of Energy Assurance Resilient Energy Demonstration Initiative (REDI); lead installation for pilot project of design and procurement of smart, cyber secure microgrids. Assessing the microgrid’s capability and development of onsite power generation on critical installations.
- c. Solar Array Power Purchase Agreement (PPA) off-base production, delivered to JBMDL substations, combined peak output of 10-15MW, favorable towards New Jersey Renewable Energy Credit (SREC) program with JBMDL a key installation in the Air Force Requirement for at least 7.5% of renewable electricity from FY13-present.
- d. NJ Land / United Communities (UC) 30-year PPA, private contract between NJ Land and UC Privatized Housing providing benefits of electricity price hedging, increased project re-investment account (for renovations / new construction), energy security and storage and configured for “microgrid ready”.

6. Comply with the following environmental initiatives:

- a. KC-46A MOB 4 Environmental Impact Statement
- b. New Jersey Natural Gas (NJNG) Southern Reliability Link (SRL) Environmental Assessment for Proposed Action of granting an easement to NJNG for the construction, operation, and maintenance of a natural gas pipeline segment on JBMDL.

B02. STREET ENVELOPE STANDARDS

Comply with Air Force Corporate Standards for Installation Elements:

<http://afcs.wbdg.org/installation-elements/index.html>

Comply with AF Corporate Standards for Street Envelope Standards:

<http://afcs.wbdg.org/installation-elements/street-envelope-standards/index.html>

B02.1. Hierarchy of Streets

Applicable N/A Large graphics

Applicable N/A Small graphics

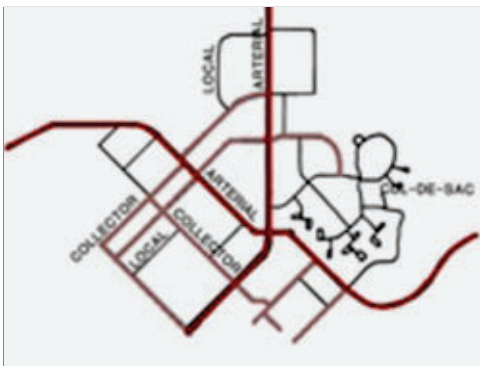

Hierarchy of Streets

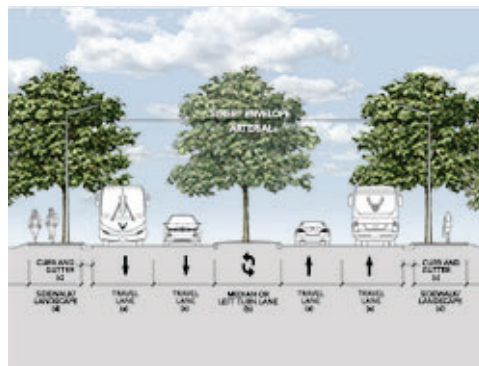

Street Envelope Section

1. Develop and evolve a hierarchical transportation network of arterial, collector and local streets following UFC 3-201-01 and its industry references.
2. Provide consistent functionality throughout the installation and a level of visual quality relating to the adjacent Facility Group number.
3. Routes along facilities in Group 1 may have materials, finishes and features with a higher visual quality than Groups 2, 3 and 4. Reduce maintenance requirements by installing highly durable materials and finishes in routes along Group 3 industrial facilities.
4. Special routes may have a visual quality comparable to those along facilities in Group 1.
5. Create and maintain arterials with two lanes of traffic in each direction with landscaped or paved medians as applicable to the local climate and adjacent facility group designation / land use.
6. Minimize stops and turns along arterials. Eliminate on-street parking along arterials and collector streets.

7. Connect arterials to local streets with appropriately scaled collector streets.
8. Provide appropriate landscape setbacks and pedestrian buffers along all streets.
9. Minimize and consolidate curb cuts along streets.
10. Ensure access for emergency and service vehicles.
11. Define bicycle traffic routes in the Installation Development Plan or its applicable component plans.
12. Define appropriate force protection features, site furnishings, signs, lighting, utilities, and paving in the IFS.

B02.1.1. Arterial Streets

- Applicable N/A Large graphics
- Applicable N/A Small graphics

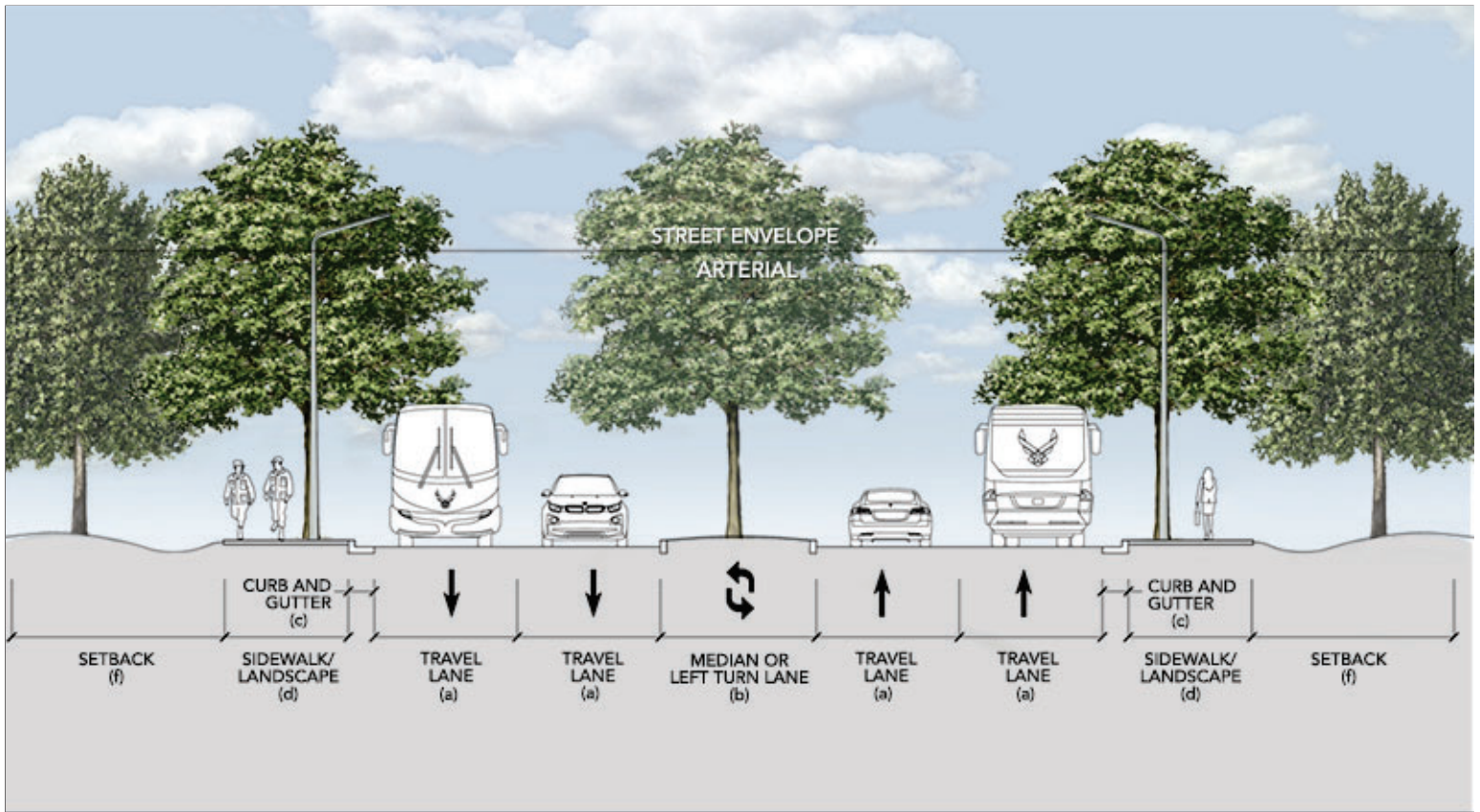

Travel Lane (a): 12' Median (b): 12' Curb and Gutter (c): 2' Sidewalk / Landscape (d): 12' Setback (f): Min. 35' or per ATFP

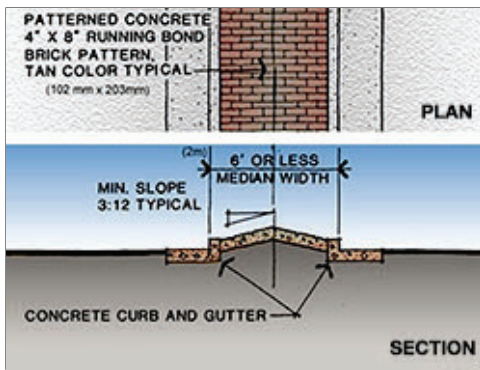

Paved Median

1. Stops and turns should be minimized and on-street parking shall not be allowed at any point along arterial streets.
2. Provide sidewalks on at least one side of arterial streets and both sides of arterial streets in developed areas. Provide a 6 foot buffer between the road and sidewalk where space allows.
3. Limit curb cuts on arterial streets to entries into major facilities, building groups and major parking areas.
4. Reinforce the importance of arterial streets with appropriate signs, plantings and street lighting.

B02.1.2. Collector Streets

- Applicable N/A Large graphics
- Applicable N/A Small graphics

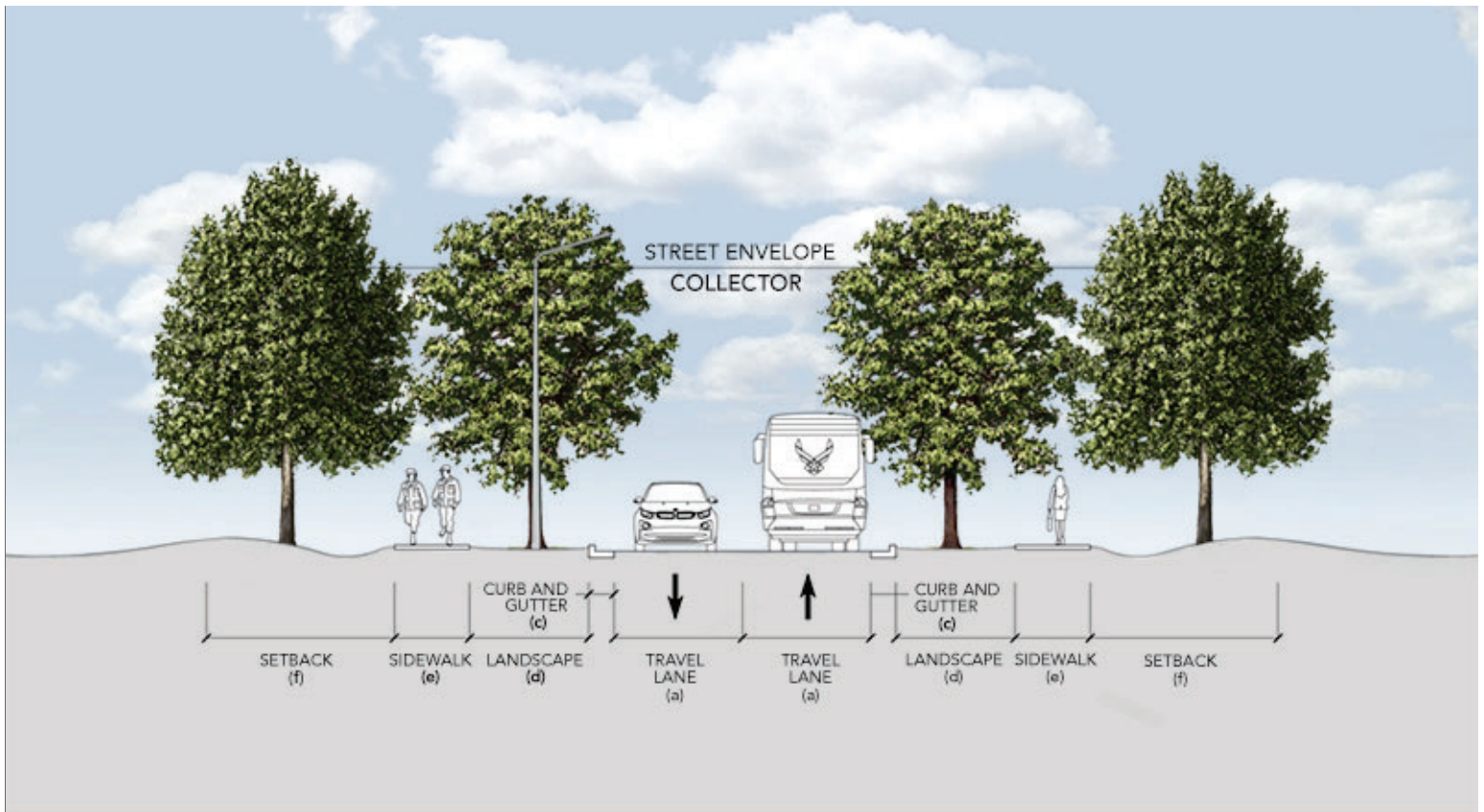

Travel Lane (a): 12' Median (b): N/A Curb and Gutter (c): 2' Landscape (d): 10' Sidewalk (e): 6' Setback (f): Min. 35' or per ATRP



Collector Street in Facility Group 4



Collector Adjacent to Facility Group 2

1. Provide sidewalks on at least one side of collector streets and both sides of collector streets where functionally required. Buffers are preferred but not required on collector streets.
2. On street parking may be allowed on one side where secondary roads are over 28 feet wide but not less than 34 feet wide. Parking shall not interfere with intersections or traffic flow.
3. Signs, plantings and street lighting should reinforce the designation of "collector" street.

B02.1.3. Local Streets

Applicable N/A Large graphics

Applicable N/A Small graphics

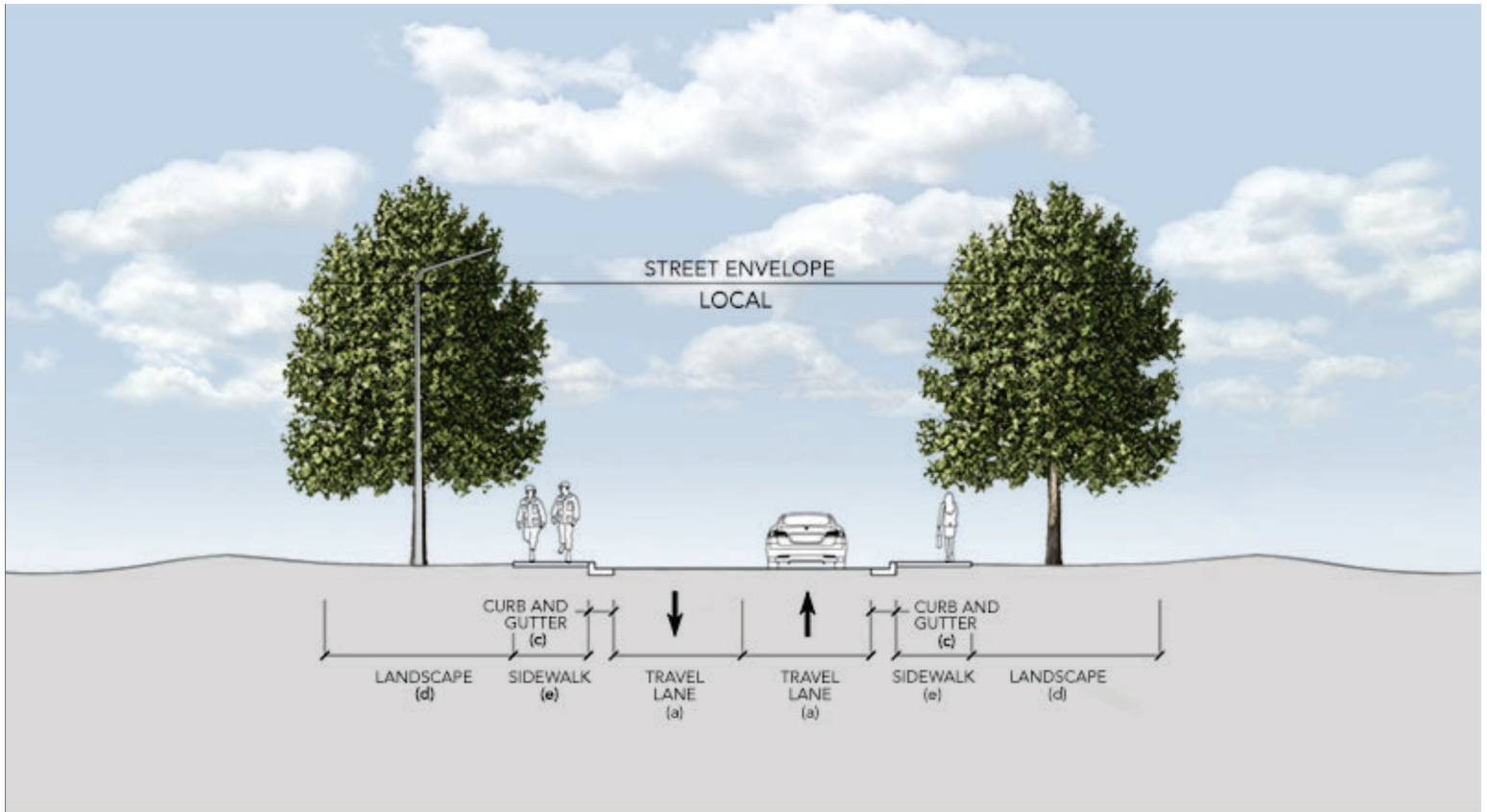

Travel Lane (a): 11' Median (b): N/A Curb and Gutter (c): 1.5' Landscape (d): 15' Sidewalk (e): 6'

1. Provide sidewalks on at least one side of collector streets and both sides of local streets where functionally required. Buffers are preferred but not required on collector streets.
2. On street parking may be allowed following UFC industry references.
3. Signs, plantings and street lighting should reinforce the designation of "local" street.
4. Cul-de-sacs are only permitted in family housing areas.

B02.1.4. Special Routes

Applicable N/A Large graphics

Applicable N/A Small graphics

1. Develop all special routes consistently with those adjacent to Group 1 facilities.

B02.2. Hierarchy of Intersections

Applicable N/A Large graphics

Applicable N/A Small graphics

1. Provide a hierarchy of intersections to include arterial, arterial-collector, collector, collector-local and local following UFC 3-201-01 and its industry references.
2. Passive systems such as traffic circles are preferred to active systems such as signalized intersections. Aggressively pursue passive systems to lower maintenance requirements and reduce energy use.
3. Use a level of visual quality for an intersection equal to the quality found in the related streetscape, which corresponds to the adjacent Facility Group number.
4. Streets should intersect at right angles and offset intersections should be avoided.

B02.2.1. Arterials

Applicable N/A Large graphics

Applicable N/A Small graphics

1. Provide an informal grouping of low lying native ground cover and shrubs with trees as a backdrop at all four corners. Monuments and static displays may be integrated into arterial intersection designs.

B02.2.2. Arterial/Collector

Applicable N/A Large graphics

Applicable N/A Small graphics

1. Provide an informal grouping of low lying native ground cover and shrubs with trees as a backdrop at all four corners.

B02.2.3. Collectors

Applicable N/A Large graphics

Applicable N/A Small graphics

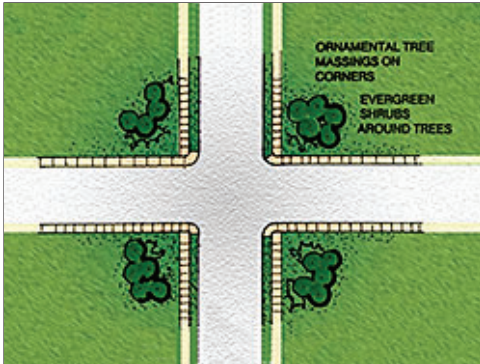

Collector Intersection Diagram

1. Provide an informal grouping of low lying native ground cover and shrubs with trees as a backdrop at all four corners.

B02.2.4. Special Intersections

Applicable N/A Large graphics

Applicable N/A Small graphics

1. Develop all special intersections consistently with those adjacent to Group 1 facilities.
2. Maintain the following intersections in this category: Wrightstown, Gate, and Circle.

B02.2.5. Street Frontage Requirements

Applicable N/A Large graphics

Applicable N/A Small graphics

1. Consistently maintain open space buffers following B03.2.3. Preserves.
2. Refer to C06.1.7. Streetscape Landscaping for planting and screen wall requirements along street frontage.

B02.2.6. Sight Lines

Applicable N/A Large graphics

Applicable N/A Small graphics

1. Provide adequate sight lines for an effective and safe traffic operation per American Association of State Highway and Transportation Officials (AASHTO) standards and local municipality guidelines.

B02.3. Street Elements

Applicable N/A Large graphics

Applicable N/A Small graphics

1. Emulate the streetscape area's pre-development hydrology using passive and active design features to help sustain the adjacent regionally appropriate landscape. Coordinate with the base Stormwater Management Plan.
2. Employ systems, materials and techniques to maximize streetscape sustainability. Consider pervious paving and reflectivity of surfaces appropriate for the local climate.
3. Install at-grade curbing and/or raised-profile curb and gutter as applicable to direct stormwater to bioswales and rain gardens as source water for vegetation. Do not paint concrete curbing.
4. Provide all on-site utility service lines and equipment below grade when adjacent to Facility Group 1. In routes along Group 2, 3 and 4, when mounting elements such as utility cabinets, communications equipment and water valves above grade is unavoidable, paint these consistently and provide visual screening following Installation Facilities Standards (IFS).
5. Provide traffic control devices including access control point/entry control facility signs, speed limit signs and street name signs following the current edition of the Manual on Uniform Traffic Control Devices (MUTCD) per UFC 3-120-01.
6. Follow UFC 3-120-01 for directional and wayfinding signs and address both vehicular and pedestrian traffic.
7. Reduce energy consumption and reduce maintenance requirements by providing street lighting only when functionally required to ensure safety and to address antiterrorism following UFC 4-010-01. Ensure the quality and quantities of lighting and fixtures are appropriate for the adjacent Facility Group number.

B02.3.1. Paving

Applicable N/A Large graphics

Applicable N/A Small graphics



Typical Asphaltic Concrete Paving

1. Pavement design shall comply with UFC 3-250-01. Ensure appropriate analysis and design of subgrade conditions to promote low maintenance, high performance pavements. Apply all applicable best practices from Appendix B of the UFC.
2. Materials shall be specified in accordance with UFC 3-250-01 and must conform to requirements set forth in the Unified Facility Guide Specifications (UFGS) for concrete and bituminous pavement.

B02.3.2. Curb and Gutter

Applicable N/A Large graphics

Applicable N/A Small graphics

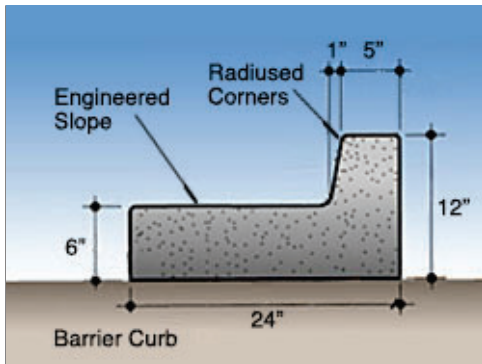

Base Standard Curb

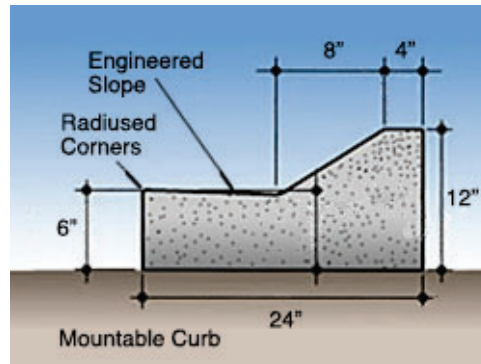

Residential Curb

1. Curb all parking, access roads and streets (except remote/isolated).
2. All streets should have integral concrete curbs and gutters. Painted curbs are prohibited because they are very difficult to maintain.
3. Use concrete for sidewalks and curbs. Do not use asphalt curbs.

B02.3.3. Utility Service Elements

Applicable N/A Large graphics

Applicable N/A Small graphics

1. Provide all utility service lines below grade when streets are adjacent to Facility Group 1; when mounting elements (such as utility cabinets, communications equipment and water valves) above grade is unavoidable, paint these consistently and provide visual screening following Site Development, Landscaping.
2. Overhead service lines along streets adjacent to Facility Groups 2, 3 and 4 are discouraged.

B02.3.4. Traffic Signs

Applicable N/A Large graphics

Applicable N/A Small graphics

1. Refer to Exterior Signs, Colors and Types for Traffic Control Devices, which includes signs.

B02.3.5. Street Lighting

Applicable N/A Large graphics

Applicable N/A Small graphics



Standard Street Light Fixture

1. Refer to the Lighting section for appropriate applications along streets.

B02.3.6. Other

Applicable N/A Large graphics

Applicable N/A Small graphics

B03. OPEN SPACE / PUBLIC SPACE

Comply with Air Force Corporate Standards for Installation Elements:

<http://afcfs.wbdg.org/installation-elements/index.html>

Comply with AF Corporate Standards for Open Space / Public Space:

<http://afcfs.wbdg.org/installation-elements/open-space-public-space/index.html>

B03.1. Plazas, Monuments and Static Displays

Applicable N/A Large graphics

Applicable N/A Small graphics



Monument with Inscriptions



Static Display Focal Point



Static Display with Plaza



Memorial Plaza

1. Natural features and culturally or historically significant features or events may be recognized and acknowledged with physical elements such as plazas, monuments and static displays. However, limit these elements on the base to ensure judicious use of resources and to reduce ongoing maintenance requirements.
2. Design highly durable plazas, monuments and static displays with a level of quality comparable to Facility Group 1.
3. Link plazas, monuments and static displays to the pedestrian circulation system. Install landscaping, site furnishings and lighting appropriate for the application and local climate following Installation Facilities Standards (IFS).
4. Select systems, products and materials for paving, walls, and structures following IFS.

B03.1.1. Paved Plazas

Applicable N/A Large graphics

Applicable N/A Small graphics



Plaza at Installation Flagpole



Brick Paving at Plaza

1. Mitigate heat island by providing high-albedo, shaded plazas. Pervious pavers shall be used on all plazas and courtyards in Facility Groups 1 and 2; use pervious concrete in Groups 3 and 4. The designer shall incorporate appropriate expansion and construction joints.

2. Pavers shall match the color of pavers used on adjacent sidewalks using base standard range of beiges, tans, browns, or terra cotta. Bricks used on plazas shall typically be 4" x 8" size.

B03.1.2. Sculptures, Markers and Statuary

Applicable N/A Large graphics

Applicable N/A Small graphics



At-Grade Marker and Plaque



Wall-Mounted Bronze Plaque

1. Relate new sculpture, markers and statuary to the base's architectural design theme. Generally limit these elements to frequently used locations adjacent to Facility Group 1 and highly traveled community pedestrian spaces.

2. Consider entry gates as possible sites for new displays.

3. All proposed memorials shall follow AFI 36-3108 and be limited to highly deserving individuals or groups as deemed appropriate by the installation leadership. Living memorials (tree plantings / etc.) are discouraged due to added maintenance requirements.

- 4. When sculpture requires a base, match the materials and / or color palette of adjacent buildings.
- 5. Use direct or indirect lighting to accentuate features or enhance an intended effect.
- 6. Ensure that all sculpture, markers and statuary are honorable and inspiring, provide a sense of place, positively contribute to the base's visual quality, and encourage pride for the community and the US Air Force.

B03.1.3. Static Display of Aircraft

- Applicable N/A Large graphics
- Applicable N/A Small graphics



Display Adjacent to Roadway



Display with Plaza Seating



Display in Park Setting

- 1. Follow IFS base-wide standards for all elements of the display area with specific attention to traffic sight lines, pedestrian circulation, site furnishings, signs, and lighting. Address requirements for the Facility District as well.
- 2. Generally locate concrete base/foundation structures for static displays below grade.
- 3. At static displays where pedestrian paths are provided, a minimum of one trash receptacle and one bench shall be provided. Receptacle and bench design must conform to IFS requirements.

B03.2. Grounds and Perimeters

- Applicable N/A Large graphics
- Applicable N/A Small graphics



Flag Array Near Main Gate



Main Gate and Canopy

- 1. Provide formal spaces for parade and review functions, recreational areas and parks following the base's Installation Development Plan (IDP) and Installation Facilities Standards (IFS). Refer to the Site Furnishings topic for additional information.

2. Maintain preservation areas following the IDP and IFS.
3. Comply with UFC 4-010-01 DoD Minimum Antiterrorism Standards for Buildings and UFC 4-022-03 Security Fences and Gates for all elements associated with the base's gates and perimeter fence.
4. Identify and describe base-wide utility corridors in the IDP.
5. Base-wide utility infrastructure shall be inconspicuous. Bury utility service lines below grade when adjacent to Facility Group 1 and when economically feasible for Facility Groups 2, 3 and 4. When service lines are located above grade, create an ordered, coordinated appearance.
6. Follow the requirements of this IFS regarding all utility structures and service lines located above grade that visually impact the installation.
7. Where screening of utility equipment and structures is provided, allow adequate and proper clearance for safety and maintenance.
8. Reduce visual clutter and visual impact of the following items through a combination of careful placement, screen walls, landscaping and painting:
 - Electrical switch-stations.
 - Sewage lift stations.
 - Water well pumps, storage tanks and/or related structures.
 - Gas piping, meters and similar incidental items.
 - Above ground fuel storage tanks.
 - Any ground-mounted freestanding utility item exposed to view.
9. Larger structures such as electrical switch-stations, sewage lift stations, fuel storage tanks and mechanical/electrical equipment shall be screened from view, using materials, forms, and colors in the screen walls which match those respective design elements present at adjacent buildings.
10. Where feasible Paint aboveground equipment and associated components such as electrical piping or exposed plumbing lines dark bronze.
11. Maintain currently buried utility service lines as a visual asset.
12. Bury the following exposed above-grade items in future projects when economically feasible:
 - Electrical power grid and service lines.
 - Telephone lines.
 - Cable TV lines.
 - Communications lines.
 - Exterior lighting service lines.
 - Any similar system of aboveground lines serving the base.
13. Consolidate and enclose service utility lines in underground utility corridors when feasible. Create routes along the inside edge of parking lot islands.

B03.2.1. Parade Grounds

Applicable N/A Large graphics

Applicable N/A Small graphics



Paved Exhibition Area

1. Follow UFC 3-201-02, Appendix B for the planning and design process and criteria for parade grounds.
2. Establish and maintain parade grounds only where there is a confirmed need and provide landscape materials appropriate for the locale following IFS.
3. Bleachers may be installed only when there is a documented requirement at parade grounds. Nonferrous metals that do not require painting or going maintenance are preferred. The Base Civil Engineer shall determine quantities, sizes, and products on a case basis.

B03.2.2. Parks

Applicable N/A Large graphics

Applicable N/A Small graphics



Public Gathering Space



Recreational Field

1. Bleachers may be installed only when there is a documented requirement at parks and fields for recreational events. Follow guidance under Parade Grounds.
2. Picnic pavilions may be provided in parks where there is a documented need.

B03.2.3. Preserves

Applicable N/A Large graphics

Applicable N/A Small graphics



Open Space Training Area



Open Space Adjacent to Flightline



Open Space Adjacent to Facility

1. Preserve areas adjacent to runways, taxiways, aprons, golf course roughs, storage areas, antenna facilities, and ammunition storage areas, as open space.
2. Provide minimal maintenance with mowing as needed for controlling bird behavior for airfield safety, or eliminating fire hazards.

B03.2.4. Perimeter Fence

Applicable N/A Large graphics

Applicable N/A Small graphics



Perimeter Fence at Gate



Integrated Fencing at Gate



Brick Piers and Metal Fencing

1. Design, install and maintain the base's perimeter fence following UFC 4-022-03.
2. Stringently comply with ATFP requirements following UFC 04-010-01 for all spaces adjacent to the base's perimeter fence and all gates.
3. Fencing, gates and other elements that are associated with the main gates shall be a level of quality equivalent to Facility Group 1.
4. Maintain a positive visual quality along the traffic corridor on both sides of the main gates. Specifically address pedestrian access, circulation and common areas.

C. SITE DEVELOPMENT

Comply with Air Force Corporate Standards for Site Development:
<http://afcfs.wbdg.org/site-development/index.html>

C01. SITE DESIGN

Comply with Air Force Corporate Standards for Site Development:
<http://afcfs.wbdg.org/site-development/index.html>

Comply with AF Corporate Standards for Site Design / NEPA:
<http://afcfs.wbdg.org/site-development/site-design-nepa/index.html>

C01.1. Site Design Considerations

Applicable N/A Large graphics

Applicable N/A Small graphics

1. Collect documentation to validate approvals and completion of the NEPA process.
2. Ensure site design compliance with the Installation Development Plan (IDP) and its component plans and Installation Facilities Standards (IFS).
3. Promote integrated design with on-site solutions such as engineered small-scale hydrologic controls versus base-wide infrastructure; consider open space, natural features, bioswales, building roofs, streets, and paved surfaces.
4. Limit the impact of development on land and water resources. All site elements and infrastructure shall reinforce an image of sustainability, with reduced energy demand, renewable-energy usage, and water conservation.
5. Consider energy conservation during site design for the following categories: building and site lighting, auxiliary systems and equipment (refrigerators, elevators, etc.), building envelope, electric power and distribution, HVAC systems and equipment, service hot water, energy management (metering, EMCS).
6. Coordinate on-site renewable-energy systems and components to minimize area requirements and maximize efficiencies. Appropriately buffer and screen these and other mechanical systems and equipment.
7. New building projects should preserve open space and protect natural habitat.
8. Conform to existing topography to the greatest extent possible and use slopes to increase site and building efficiencies. Design sites to minimize irrigation and impacts to stormwater runoff. Use natural topography to buffer views of major streets when possible.
9. Carefully study new project sites to identify the character of adjacent buildings, streets, landscaping, and site design elements. Reinforce the existing character in new site design.
10. Consider relationships to adjacent facilities and district / centralized heating and cooling infrastructure and cost effectively connect building systems to harvest heat, grey water or other beneficial byproducts.
11. Minimize existing and planned obstructions from landscaping, structures, topography, and adjacent developments to preserve solar access and natural ventilation.
12. Purposefully integrate service access, receiving and storage areas to eliminate the need for visual screening.
13. Appropriately connect to the base network of streets, sidewalks and trails using drive aisles, parking areas, walkways, paths, and bicycle routes addressing both vehicles and pedestrians.
14. Applicably coordinate heat island mitigation in paving and roof designs when implementing an integrated approach to stormwater management.

15. Consider the location of "Designated Tobacco Areas."

16. Refer to section C06 for standards regarding use of landscape to define entries, control pedestrian circulation, control vehicular traffic, and for screening undesirable views and parking areas.

C01.2. Building Orientation

Applicable N/A Large graphics

Applicable N/A Small graphics

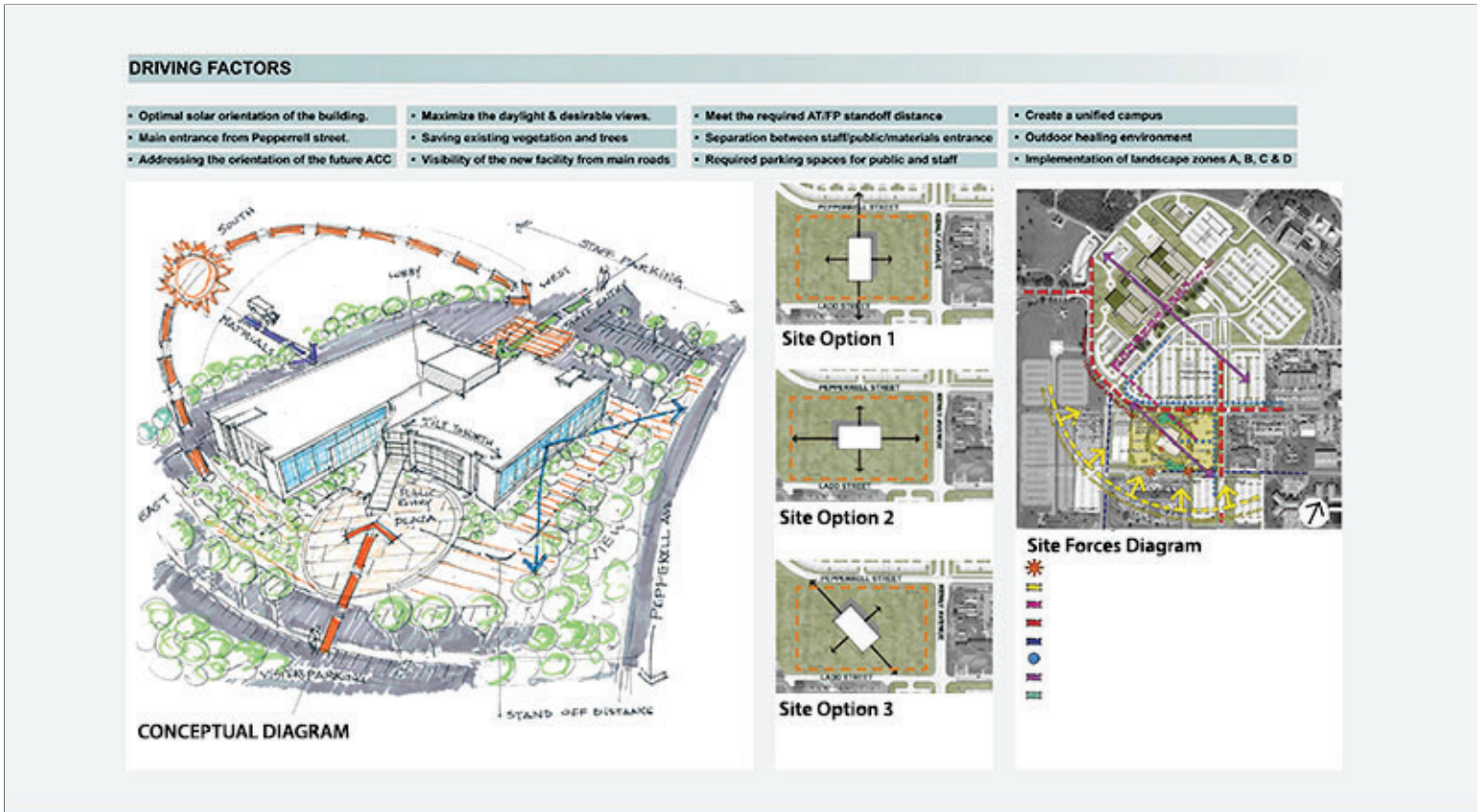

Conceptual Site Analysis and Site Design Diagram

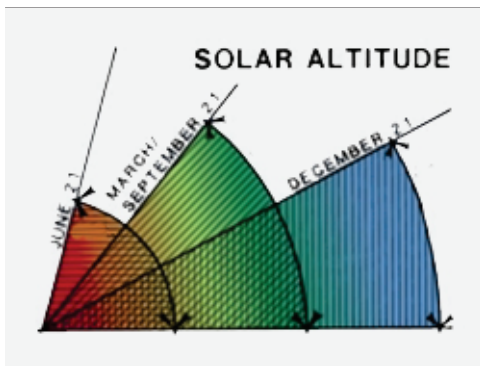

Local Solar Data

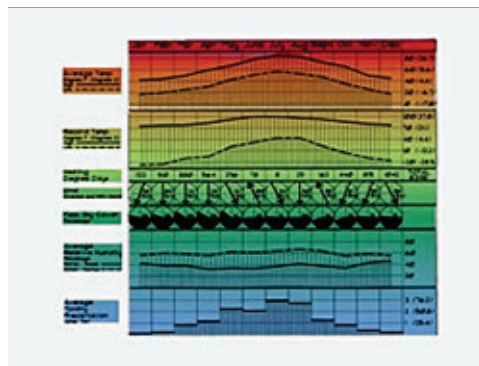

Local Climate Data

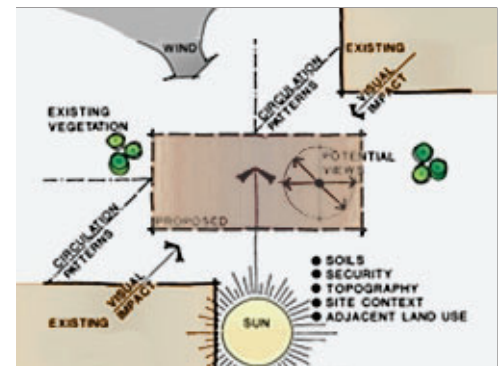

Site Data

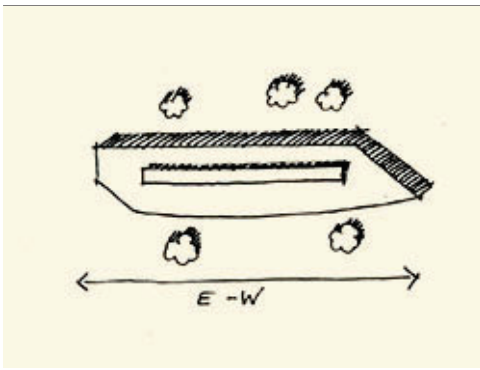

East-West Axis

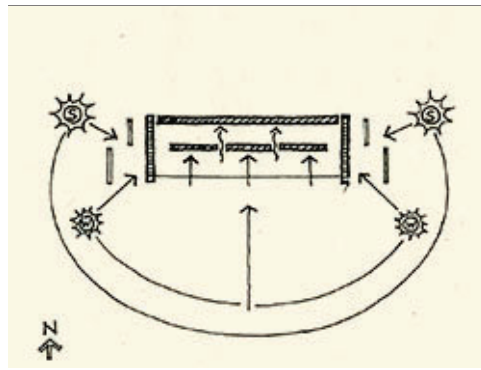

Optimum Solar Control

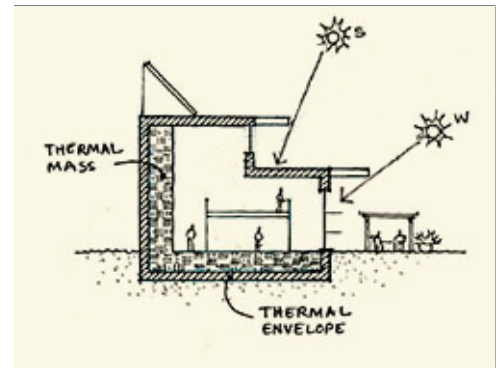

Maximized Shading

1. Ensure the site will accommodate optimum requirements for building orientation, which is with the long axis parallel to the east/west direction for rectilinear CONUS buildings.
2. Meet Installation Facilities Standards (IFS) requirements for the locations of the building's passive and renewable-energy systems—including geothermal and solar systems—and exterior shading systems.
3. Locate the building(s) and permitted ancillary structures to promote solar gain, solar shading, natural ventilation, rainwater harvesting, wind buffering and other beneficial passive systems. Consider natural ventilation during the design of HVAC systems.
4. Consider relationships to adjacent sites and their facilities and infrastructure, and cost effectively integrate building systems to harvest heat, grey water or other beneficial byproducts.
5. Consider the "public side" of the building, its views and the location of the main entrance.

C02. UTILITIES

Comply with AF Corporate Standards for Site Development:
<http://afcs.wbdg.org/site-development/index.html>

Comply with AF Corporate Standards for Utilities:
<http://afcs.wbdg.org/site-development/utilities/index.html>

C02.1. Utility Components

- Applicable N/A Large graphics
- Applicable N/A Small graphics



Elevated Water Storage



At-Grade Electric Service



Compatible Utility Structure

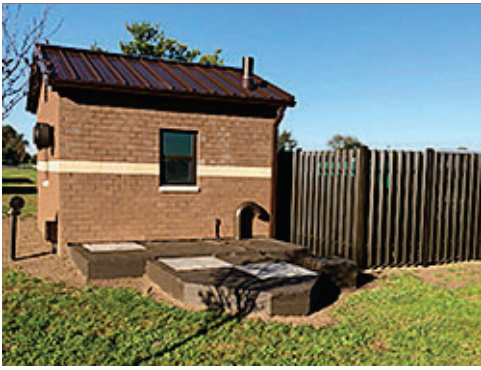

Compatible Sewage Lift Station



Painted Electric Cabinet



Fire Service Standpipe

1. Provide all on-site utility service lines below grade for Facility Group 1; when mounting elements (such as utility cabinets, communications equipment and water valves) above grade is unavoidable, paint these consistently and provide visual screening following Installation Facilities Standards (IFS).
2. Provide installation of utility infrastructure to support near term and future electric vehicle charging stations.
3. Define all service entry points into the building and route distribution below grade into an interior space within the facility; exposed conduits, cables and wires on exterior walls are not permitted for Facility Group 1.
4. Include consideration of appropriate placement of meters in support of Automated Revenue Management Services (ARMS).
5. Limit exterior mechanical distribution systems such as exterior steam, chilled water, and hot water distribution to Group 3 facilities; when required for Group 1 and 2 facilities integrate with the architecture and provide visual screens following IFS.
6. Direct roof drainage to underground collection when feasible or provide splash blocks / paved channels to intercept roof drainage at grade.

C03. PARKING AREAS

Comply with AF Corporate Standards for Site Development:

<http://afcfs.wbdg.org/site-development/index.html>

Comply with AF Corporate Standards for Parking Areas:

<http://afcfs.wbdg.org/site-development/parking-areas/index.html>

C03.1. Configurations and Design

Applicable N/A Large graphics

Applicable N/A Small graphics

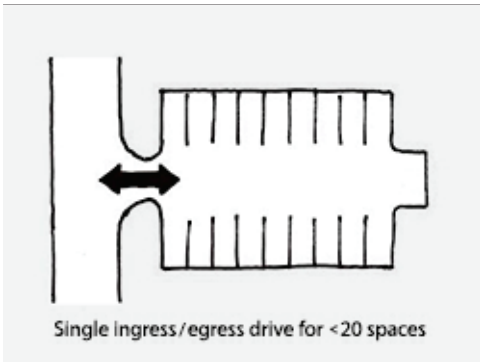

Small Lot Configuration

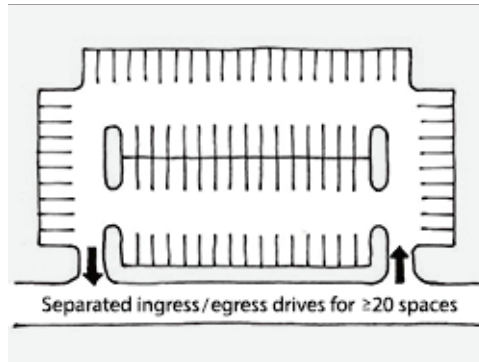

Large Lot Configuration

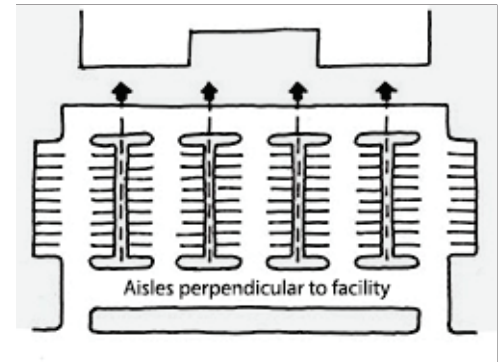

Facility Group 1 Configuration



Central Median with Walkway



Landscaped Median and Island



Accessible Parking at Building Entrance

1. Evaluate adjacent sites and cost-effectively consolidate parking areas to maximize efficient use; ensure that all areas meet accessibility guidelines.
2. Generally envision on-site parking as a series of small connected singular areas selectively placed around the facility served, rather than a single large area; buffer parking areas from the facility main entrance with a transition space and provide drop-offs to decrease close-in parking. Comply with IFS standards while meeting ATRP requirements.
3. Integrate at-grade and raised-profile curbing, permeable paved areas, and parking islands with the stormwater system and direct stormwater to bioswales and rain gardens as source water for regionally appropriate native vegetation.
4. Define pedestrian access with approved hardscape and provide shading along the primary path from the parking area to the main entrance of the building.
5. Coordinate suitable landscape or barriers integrated with walls and fences to ensure adequate force protection.
6. Accessible parking spaces shall be marked according to UFC 3-120-01 and its references in ABAAS and the MUTCD.
7. Consider locations and requirements of near term and future electric vehicle charging stations.
8. Designate preferred parking spaces for electric vehicles and carpools near the main entrance.
9. Consider cost-effectively integrating solar photovoltaic arrays into covered parking structures.
10. Reserved parking is discouraged except for Facility Group 1.

11. On-street parking is discouraged except in multi-use areas. When used, provide approved on-street parking configurations following UFC 3-201-01.

12. Access and service drives should accommodate the largest vehicle serving the facility.

C03.1.1. Paving and Striping

Applicable N/A Large graphics

Applicable N/A Small graphics



Asphaltic Concrete Paving and White Striping

Facility Group 1 paving materials shall be as follows.

Primary: Asphaltic concrete

Secondary: Concrete

Accent: Permeable pavers

Facility Group 2 paving materials shall be as follows.

Primary: Asphaltic Concrete

Secondary: N/A

Accent: N/A

Facility Group 3 paving materials shall be as follows.

Primary: Concrete where operationally required

Secondary: Asphaltic Concrete

Accent: N/A

Facility Group 4 paving materials shall be as follows.

Primary: Asphaltic Concrete

Secondary: N/A

Accent: N/A

1. Define all parking lots with either raised profile or at-grade curbing to promote drainage and protect paving edges. All raised curbs shall be the rolled (mountable) type.

2. Integrate curbing to direct stormwater to bioswales and rain gardens as source water for regionally appropriate native vegetation.

3. Wheel stops are not permitted except at locations where car bumpers could contact adjacent items such as poles, signs or pedestrians.

C03.1.2. Curbing

Applicable N/A Large graphics

Applicable N/A Small graphics

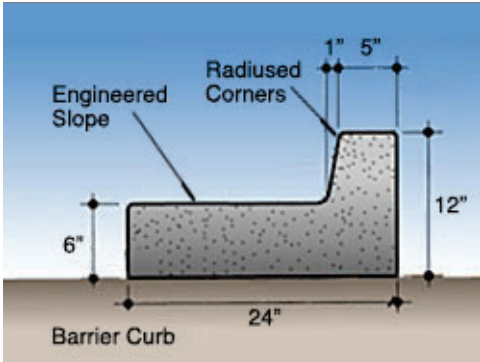

"Barrier" Curb

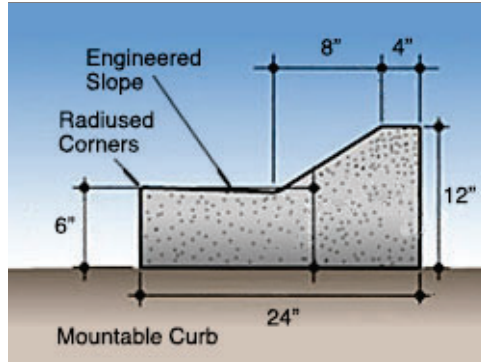

"Mountable" Curb

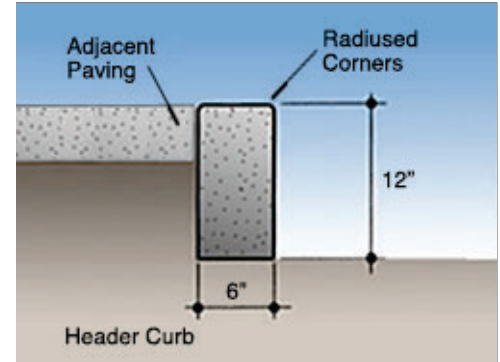

Header Curb

Facility Group 1 curbing / edging materials shall be as follows.

Primary: Concrete

Secondary: N/A

Accent: N/A

Facility Group 2 curbing / edging materials shall be as follows.

Primary: Concrete

Secondary: N/A

Accent: N/A

Facility Group 3 curbing / edging materials shall be as follows.

Primary: Concrete

Secondary: N/A

Accent: N/A

Facility Group 4 curbing / edging materials shall be as follows.

Primary: Concrete

Secondary: N/A

Accent: N/A

1. All new parking lots in Groups 1 and 2 shall be constructed of asphalt paving.
2. Porous paving may be considered on a case basis.
3. Cost-effectively provide light-colored concrete to reduce heat island effect; otherwise install asphaltic concrete paving. Dirt, gravel, and grass lots are not allowed.
4. Use consistent striping, angles and stall sizes in all parking areas.
5. All parking shall be marked with white stripes of paint or applied vinyl coatings. Red or yellow markings shall only be used for safety purposes and must be kept to a minimum. All lines shall be four inches (4") wide.

C03.1.3. Internal Islands and Medians

Applicable N/A Large graphics

Applicable N/A Small graphics

1. Install landscape islands and medians as visual breaks, to reduce heat island effects and to accommodate bioswales and rain gardens with consideration for snow removal. Coordinate suitable landscape or barriers integrated with walls and fences to ensure adequate force protection.

2. When lighting is necessary, contain fixture bases within medians or internal landscape islands.

C03.2. Parking Structures

Applicable N/A Large graphics

Applicable N/A Small graphics

1. Parking structures are encouraged in land-constrained locations when economically feasible.

2. Consider near term and future electric vehicle charging stations and renewable energy generation development during the analysis and design.

3. Consider opportunities for integrating parking structures into multi-use developments with pedestrian-oriented uses located on the ground floor and parking on upper levels; ensure AFTP guidelines are fully addressed.

4. Structures may be constructed below grade with roofs serving as vegetated areas or plazas.

C03.3. Connectivity

Applicable N/A Large graphics

Applicable N/A Small graphics

1. Refer to the Installation Development Plan (IDP) for locations of transit stops and pedestrian and cycling networks; provide appropriately sized sidewalks and bike paths to connect facilities and users to these networks.

2. Provide amenities such as rain and shade shelters, trees, and benches to encourage and facilitate use of public transportation.

3. Evaluate the IDP for the current and planned network of roads and optimally develop vehicular access to and from the site.

C04. STORMWATER MANAGEMENT

Comply with AF Corporate Standards for Site Development:

<http://afcfs.wbdg.org/site-development/index.html>

Comply with AF Corporate Standards for Stormwater Management:

<http://afcfs.wbdg.org/site-development/stormwater-management/index.html>

C04.1. Stormwater Requirements

Applicable N/A Large graphics

Applicable N/A Small graphics



Drainage Area with Grasses



Reinforced Culvert



Retention Area as an Amenity



Stabilized Drainage Surface



Bridge as an Amenity



Storm Inlet and Culvert

1. Design all stormwater systems including retention ponds, detention areas, channels, etc. as on-site amenities that are consistent with natural systems and drainage patterns, that help sustain the base landscape with beneficial functionality and that provide aesthetic appeal; coordinate with the base Stormwater Management Plan.
2. Incorporate bioswales into the design of all roadway, parking and facility roof systems to enhance water quality and support the overall stormwater system.
3. Permeable paving may be used in areas that are not subjected to severe freeze-thaw cycles.
4. Provide rainwater harvesting and storage that is attached to the building's roof drain systems to support grey water irrigation; consider freeze protection for winter months.
5. Where low-slope roofs are permitted, the roof must be drained to the exterior walls. Rain leaders should be used in lieu of exterior downspout conductors.
6. Group 1 facilities shall use closed-face gutters and downspouts on the outside of the building line. Coordinate the material and color of gutters and downspouts with roof and wall materials for Group 1, 2, 3 and 4 facilities.
7. When underground drainage systems are required establish a maintenance program to include removal of sediments and debris; inspect joints seasonally for alignment to prevent leakage and the development of voids and surface failures.
8. Cost-effectively integrate stormwater systems with ATRP measures.

C05. SIDEWALKS, BIKEWAYS AND TRAILS

Comply with AF Corporate Standards for Site Development:

<http://afcs.wbdg.org/site-development/index.html>

Comply with AF Corporate Standards for Sidewalks, Bikeways and Trails:

<http://afcs.wbdg.org/site-development/sidewalks-bikeways-trails/index.html>

C05.1. Circulation and Paving

Applicable N/A Large graphics

Applicable N/A Small graphics



Decorative Pavers



Concrete Paving in Group 2



Detached Concrete Sidewalk



Group 1 Entrance Paving



Group 2 Sidewalk with Accent Color

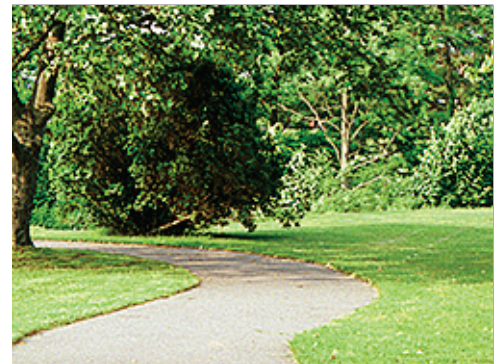

Asphaltic Concrete Trail Paving

Facility Group 1 sidewalks, plazas, and courtyards paving materials shall be as follows.

Primary: Brick or Concrete Pavers

Secondary: Concrete

Accent: Colored Concrete

Facility Group 2 sidewalks, plazas, and courtyards paving materials shall be as follows.

Primary: Concrete

Secondary: N/A

Accent: Optional: Colored Concrete

Facility Group 3 sidewalks, plazas, and courtyards paving materials shall be as follows.

Primary: Concrete

Secondary: N/A

Accent: N/A

Facility Group 4 sidewalks, plazas, and courtyards paving materials shall be as follows.

Primary: Concrete

Secondary: N/A

Accent: N/A

1. Maintain efficient geometry and accessibility to connect building entrances to adjacent parking areas and activity areas and to the base transportation system following ATFP. Efficiently use materials to optimize life-cycle costs and to minimize maintenance.
2. Generally conform horizontal layouts of sidewalks to the geometric configuration of adjacent buildings, streets, parking lots, and other adjacent related site amenities. Occasional meanders and/or jogs may be included to capture views, to coordinate with landscaping or accommodate site constraints.
3. Walks in parking areas shall provide a direct path using "safe islands" and "peninsulas" to encourage safety. Walks parallel to streets shall follow streetscape guidelines. Clearly mark pedestrian crossings at vehicular routes.
4. Mitigate heat island by providing high-albedo, shaded sidewalks. Pervious pavers shall be used on all sidewalks, plazas and courtyards in Facility Groups 1 and 2; use pervious concrete in Groups 3 and 4. The designer shall incorporate appropriate expansion and construction joints.
5. Only experienced contractors will install pervious pavements.
6. Consider an integrated approach that could include stormwater management (permeable surfaces) and complement the design of the storm drainage system when appropriate.
7. Pedestrian paths should be at least 5' in width to allow for comfortable side-by-side walking.
8. Sidewalks leading to a building main entrance and at the interior of parking lots shall be a minimum width of 6'. Walks greater than 10' wide may be used at high-density pedestrian areas where volumes of traffic justify added material.
9. Where cars park adjacent and head-in to the sidewalk and wheel stops are not used, such perimeter walks shall be increased to a minimum width of 8' to accommodate overhangs of the parked vehicles.
10. All sidewalks shall have positive drainage to prevent ponding of water or ice accumulation with slopes ranging from 2.1% to 4.2%. Walks with a slope greater than 4.2% shall be designed as ramps following accessibility guidelines. All walks shall have a minimum cross slope of 2.1%.
11. Paver's shall be brick to match the adjacent facilities or gray concrete color to match sidewalks in the area. Paver's used on walks shall typically be 4"x8" nominal size.
12. Connect to the bicycle circulation system and provide bicycle parking with a suitable means for securing bicycles following IFS. Consider changing/shower facilities for use by cyclists.
13. Refer to the Installation Development Plan for future trails, bicycle paths, and sidewalks.

C05.1.1. Ramps and Stairs

Applicable N/A Large graphics

Applicable N/A Small graphics



Accessible Ramp

1. Use ramps instead of stairs for sidewalks, bikeways and trails and at all buildings where possible. Where steps are unavoidable, follow UFC 1-200-01 and its references to the International Building Code.

C05.1.2. Lighting

Applicable N/A Large graphics

Applicable N/A Small graphics

1. Provide lighting for all stairs and landings where traffic warrants.
2. Refer to the Lighting section for path lighting along sidewalks, bikeways and trails.

C06. LANDSCAPE

Comply with AF Corporate Standards for Site Development:

<http://afcfs.wbdg.org/site-development/index.html>

Comply with AF Corporate Standards for Landscape:

<http://afcfs.wbdg.org/site-development/landscape/index.html>

C06.1. Climate-based Materials

Applicable N/A Large graphics

Applicable N/A Small graphics



Native Trees and Grasses



Trees for Shading

1. Use only native, naturally occurring, drought tolerant indigenous plant species (including grasses) appropriate for the locale to promote energy efficiency and water conservation, preserve drainage patterns, inhibit erosion, improve air quality, lower maintenance, and add beauty.
2. Follow details and specifications of the American Standard for Nursery Stock, current edition.

C06.1.1. Landscape Design Concept

Applicable N/A Large graphics

Applicable N/A Small graphics



Trees and Grasses as Primary Palette



Shrubs in Building Plantings



Ornamental Plants in Focus Area

1. Develop, maintain and implement a climate-based plant list with landscape features using a regionally appropriate palette of materials to promote energy efficiency, preserve drainage patterns, inhibit erosion, improve air quality, lower maintenance and add beauty. Follow UFC 3-201-02 Landscape Architecture.
2. Landscaping is required for all newly developed sites and facilities; preserve existing native landscape where possible and avoid overplanting.
3. Concentrate landscaping in Facility Group 1 and along major thoroughfares and integrate these landscaped areas into the base's stormwater management plan. Refer to the Streetscape Envelope Standards in this IFS.

4. All Facility Group 1 and 4 sites shall be landscaped at their entire perimeter; limit formal planting arrangements to formal spaces typically associated with Group 1. Landscape public spaces near the main entrances of Group 1 facilities.
5. Facility Group 2 and 3 sites may have a native undisturbed landscape except at the main entrances of Group 2, which should be newly landscaped.
6. Facility plantings shall follow the Installation Facilities Standards (IFS) plant list, which is based on the specific microclimates created by the adjacent building; shadow areas, protected areas, zones adjacent to thermal mass, and availability of rainwater and/or grey water.
7. Provide open spaces as transitions between developed and native areas that promote quality of life and provide visual relief and allow walkable connections to the transportation system.
8. Return suitable areas to a natural state to minimize and, whenever possible, eliminate ground maintenance requirements; expand prairie areas where appropriate with native plants to eliminate mowing and maintenance requirements.
9. In tree clusters replace grass with naturalized shrub beds and leaf litter mulch to eliminate mowing requirements.
10. Use plantings in open spaces to reinforce the space as a visual asset.
11. Consider landscape windbreaks when suitable for the local climate.
12. Integrate security requirements into the landscape design. Coordinate the heights of trees and shrubs and note restrictions for plantings following UFC 4-010-01.
13. Berms may be used as an integral part of the overall landscape strategy for screening, security and/or visual interest.
14. Use landscaping to define entries, control pedestrian circulation, control vehicular traffic, and for screening undesirable views and parking areas.
15. Use adapted trees and shrubs locally recommended for urban or street use that can survive without irrigation after the first season or warranty maintenance period.

C06.1.2. Xeriscape Design Principles

- Applicable N/A Large graphics
- Applicable N/A Small graphics



Drought Tolerant Planting



Xeric Plant Materials

1. Apply xeriscape principles following UFC 3-201-02, Appendix B, and Air Force Corporate Facilities Standards.
2. Facility plantings are encouraged to use native plant species and to consider specific microclimates created by the adjacent building; shadow areas, protected areas, zones adjacent to thermal mass, and availability of rainwater and/or grey water.

C06.1.3. Minimizing Water Requirements

Applicable N/A Large graphics

Applicable N/A Small graphics



Trees in Planting Beds



Trees along Drainage Area

1. Reasonably reduce demand on potable water while seeking opportunities to increase alternative water sources for irrigation. Reduce or eliminate the use of potable/domestic water for purposes of landscape architecture maintenance, consistent with existing legal or contractual obligations, and prohibit potable-water irrigation in new construction beyond establishment following current DoD and Air Force policy.

C06.1.4. Plant Material Selection

Applicable N/A Large graphics

Applicable N/A Small graphics

1. Use only native, naturally occurring plant materials including grasses or turf suited for the local climatic conditions in the landscape design; potable-water irrigation systems are discouraged beyond the establishment period.
2. Use adapted trees and shrubs locally recommended for urban or street use that can survive without irrigation after the first season or warranty maintenance period. Obtain the current Plant List from the Base Civil Engineer.
3. Trees should be the focus of landscape plantings and, where possible, should be a mix of deciduous and evergreen species for variety; provide tree grates when appropriate and use tree guards on smaller trees.
4. Ground covers are only recommended when minimal maintenance is required.
5. Turf areas should be limited to those that can be sustained by natural rainfall or grey water (non-potable) irrigation systems; turf may be defined by at-grade concrete mow strips to lessen maintenance.
6. Analyze soils and provide organic amendments as needed to improve plant growth and conserve water.
7. All plant material shall have one-year warranty and is subject to approval by the Base Landscape Architect.

C06.1.5. Water Budgeting (Hydrozones)

Applicable N/A Large graphics

Applicable N/A Small graphics

1. Comply with DoD and Air Force policy on potable-water irrigation systems.

2. Provide irrigation systems in new construction to establish plant materials following “Water for Landscaping” in UFC 1-200-02. Note the climate zone and annual rainfall for the locale.

3. New buildings shall cost-effectively integrate a grey-water reclamation system following UFC 1-200-02, which provides source water for an automatic drip irrigation system; connect adaptive plantings adjacent to facilities to a grey-water irrigation system when available and discontinue the use of potable water for irrigation after the establishment period.

4. Provide irrigation design following UFC 3-201-02. Install drip irrigation products and components following UFGS Section 32 84 24 Irrigation Sprinkler Systems. Match the color of valve box lids to the adjacent ground treatment (i.e. green at turf & native seed areas, brown at wood mulch & rock areas).

5. Life cycle cost-effectively equip irrigation systems to sense soil moisture, rainfall and wind to minimize unnecessary watering; incorporate drip irrigation systems as the primary source.

C06.1.6. Base Entrance Landscaping

Applicable N/A Large graphics

Applicable N/A Small graphics

1. At the main gate, reinforce a sense of arrival through a well-designed concentration of landscape elements consistent in visual quality with Facility Group 1.

2. Ensure landscaping has seasonal features with spring and fall color and a combination of evergreen and deciduous trees and shrubs for winter interest.

3. Integrate base signs and street and pedestrian lighting whenever feasible.

C06.1.7. Streetscape Landscaping

Applicable N/A Large graphics

Applicable N/A Small graphics



Street Tree Planting

1. Provide landscape designs with plant materials appropriately representing the level of quality of the adjacent Facility Group number. Refer to the Installation Elements section.

2. Select a variety of regionally appropriate streetscape plantings and grading to create a visual interest.

3. Formal street tree planting design should use trees of the same species spaced at regular intervals. The trunk should be no closer than 5 feet to the sidewalk.

4. Coordinate tree species selection with utility lines, signage, visual clearance requirements and other man-made constraints.

C06.1.8. Pedestrian Circulation Landscaping

Applicable N/A Large graphics

Applicable N/A Small graphics



Trees Adding Shade and Definition

1. Define walkways with landscaping where appropriate.
2. Provide rest areas along the pedestrian circulation network with human-scaled deciduous shade trees. Supplement tree plantings with finely textured shrubs when appropriate for the climate.
3. Provide wind breaks where required.
4. Tree grates should be used in lieu of planters.

C06.1.9. Parking Lot Landscaping

Applicable N/A Large graphics

Applicable N/A Small graphics



Deciduous Trees



Trees, Grasses and Shrubs



Space Defining Landscape

1. Integrate appropriate landscaping elements into parking areas to visually soften the appearance at a minimum rate of 10 percent of the total area.
2. Avoid trees that drop sap, fruit, or seeds, and use long-lived species; keep trees trimmed, removing dead and dying trees or branches.
3. Provide planting in islands within parking lots for shade and appeal following IFS and the base stormwater management plan.

4. Rain garden islands shall be landscaped to receive rainwater runoff from adjacent impervious parking areas to be absorbed into the ground/planting bed. Native plants and groundcovers are recommended within the rain garden areas, which can survive without supplemental irrigation once established.

C06.1.10. Screen/Accent Landscaping

Applicable N/A Large graphics

Applicable N/A Small graphics



Coniferous Evergreen Shrubs



Broadleaf Evergreen Shrub

1. Provide complimentary accent landscaping at monuments and static displays.
2. At Facility Group 1, provide landscaping adjacent to all freestanding signs without distracting from the written communication.
3. Provide landscape screening of utility elements adjacent to Facility Group 1.
4. Providing landscaping as visual screening is preferred to the construction of walls and fences; berming and mounding may supplement landscape screening.
5. Retain existing natural habitat as a buffer between housing and commercial or industrial uses.

C06.1.11. Other

Applicable N/A Large graphics

Applicable N/A Small graphics

C07. SITE FURNISHINGS

Comply with AF Corporate Standards for Site Development:

<http://afcfs.wbdg.org/site-development/index.html>

Comply with AF Corporate Standards for Site Furnishings:

<http://afcfs.wbdg.org/site-development/site-furnishings/index.html>

C07.1. Furnishings and Elements

Applicable N/A Large graphics

Applicable N/A Small graphics



Coordinated Site Furnishings



Fencing and Screen Wall

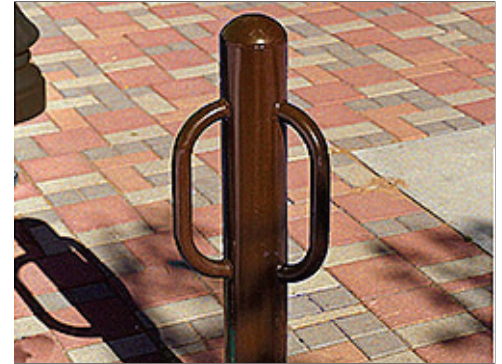

Bike Bollard

1. Provide a coordinated consistent inventory of site furnishings to positively contribute to the visual environment, image, and identity of the base; ensure durability, low maintenance, reduced visual clutter, and compatibility with the adjacent architecture.
2. Site furnishings shall meet accessibility requirements of ADA/UFAS.
3. Remove poorly located or redundant litter / ash receptacles, newspaper and bicycle racks, telephone booths, vending machines, walls and fences to reduce visual clutter and to lessen the requirements for maintenance.
4. Group 1 and 2 site furnishing shall be concrete/ and or factory finished black or brown metal. Group 3 and 4 site furnishings shall be factory finished black or brown metal. Generally match the site furniture of adjacent facilities and the facility district.
5. Install needed outdoor seating (benches and low walls) in public gathering spaces near main and secondary building entrances. Low walls shall match facility architecture.
6. Benches in Groups 1, 2 and 3 shall be concrete, or black or brown-painted metal. Provide black or brown-painted metal benches in Group 4 and parks.
7. Integrate functional bicycle racks with the design of the building's main entrance grounds in Facility Groups 1 and 2 while meeting ATRP requirements.
8. Limit the use of bollards, but when necessary for force protection use precast concrete bollards in Groups 1 and 2 Concrete filled pipe bollard bollards may be used in low-visibility areas for Groups 1 and 2 and in Group 3, parks and trails. Illuminated bollards may be used as approved on a case basis.
9. Locate architecturally coordinated containers for recycling, litter, ash, vending, etc., to minimize visual clutter and not visible from the building's main entrance. Minimize the use of freestanding planters.
10. Generally limit picnic tables, barbeque grills and drinking fountains to lodging, dormitories, housing areas, parks and recreation areas following IFS.
11. The Installation Flagpole location shall comply with the guidance for the display of flags in AFI 34-1201. Each Air Force installation is authorized to fly one United States Flag, normally in front of the installation headquarters. Waivers for non-authorized locations must be submitted in accordance with AFI 33-360 and approved waivers (AF Form 679) must be maintained by the installation protocol office.
12. Refer to the Overview Section "Facility Hierarchy" topic of this AFCFS for guidelines regarding ancillary structures such as pavilions and shade shelters.

13. Bus shelters shall be provided only where there is a documented need and when approved on a case basis. Generally emulate the designs of adjacent shelters.
14. Monuments and static displays shall be limited. New elements are generally discouraged unless these are fully vetted through the base's approval process and designed following IFS.
15. When visual screening is necessary, consider landscaping as the first option; screen walls are permitted only in Group 1 finished with red brick matching adjacent buildings.
16. For fencing, apply the standards for "Products, Materials and Color" in the following section. Limit those with the highest visual quality to Facility Group 1 where there is sustained maintenance. Define all levels of security and visual quality.
17. Do not use chain-link fencing at Group 1, 2 or 4 facilities; Limit the use of barbed-wire outriggers on chain-link fencing at industrial sites, and flight line unless required for additional security or protection of assets.
18. Wood fencing may be used in Facility Group 4 and in recreation areas following IFS for material and finish when there is sustained periodic maintenance.
19. Provide trash dumpster enclosures for Group 1, 2 and 3 with red brick to match adjacent facilities; all gates shall be metal, factory finished dark brown.
20. Specify screen wall materials and finishes that do not require painting or maintenance beyond periodic cleaning.
21. Group 1, 2, 3 and 4 picnic tables and seating shall be black or brown-painted metal. Generally limit picnic tables, barbeque grills and drinking fountains to lodging, dormitories, housing areas, parks and recreation area.
22. Limit the use of freestanding planters to areas with ongoing maintenance.
23. Provide kiosks only where there is a documented need for visual communication of posted messages. When used, match adjacent facilities in materials and detailing and consolidate kiosks with other site furnishings within 30 feet of major pedestrian paths. Limit kiosks to facility Groups 1 and 2 and parks.
24. Manufacturers listed below are only provided to establish a baseline of equivalency among all applicable manufacturers.

C07.2. Site Furnishings Products, Materials and Color

Note: *Apply the below base-wide standards for Site Furnishings (products, materials and color). Then refer to the Appendix and apply any additional requirements specifically related to the Facility District in which the project is located.*

C07.2.1. Barbeque Grills

Applicable N/A Number of base standards 2



Type: **Charcoal**

Applies to: Group 1 Group 2 Group 3 Group 4 Other

Mfr: Most Dependable Fountains, Inc.

Color: Natural stainless steel

Finish: Mill

Model #: SS BBQ Grill

Other: Concrete foundation, coordinate with Base Architect

UFGS: N/A



Type: **Natural Gas**

Applies to: Group 1 Group 2 Group 3 Group 4 Other

Mfr: BBQ Coach

Color: Natural stainless steel

Finish: Mill

Model #: 32" 4-Burner

Other: Built-in Concrete or masonry, coordinate with Base Architect

UFGS: N/A

C07.2.2. Benches

Applicable N/A

Number of base standards 1



Type: _____

Applies to: Group 1 Group 2 Group 3 Group 4 Other

Mfr: Materials, Inc. _____

Color: Dark Bronze _____

Finish: Factory _____

Model #: _____

Other: N/A _____

UFGS: N/A _____

C07.2.3. Bike Racks

Applicable N/A

Number of base standards 1



Type: **Bike Bollard** _____

Applies to: Group 1 Group 2 Group 3 Group 4 Other

Mfr: Belson _____

Color: Dark Bronze _____

Finish: Factory _____

Model #: 4-1/2" O.D., 36 inch Height _____

Other: In ground mount _____

UFGS: N/A _____

C07.2.4. Bike Lockers

Applicable N/A

C07.2.5. Bollards

Applicable N/A Number of base standards 3



Type: **Lighted Round Dome Top**

Applies to: Group 1 Group 2 Group 3 Group 4 Other

Mfr: Lithonia Lighting Products

Color: Dark Bronze

Finish: Factory finished

Model #: KBA

Other: Flared cone, 3000K LED Lamp

UFGS: N/A

Type: **Building Protection, steel**

Applies to: Group 1 Group 2 Group 3 Group 4 Other

Mfr: (Bollard Cover) Reliance Foundry

Color: Brown cover to be dark bronze

Finish: Factory

Model #: 6" Steel pipe, concrete filled, Cover: R-7173

Other: A 1" (25.4 mm) rigid conduit and box with shroud may be provided at top of bollard with a receiver/key switch application
Add reflective 8" banding at top of bollard if required

UFGS: N/A

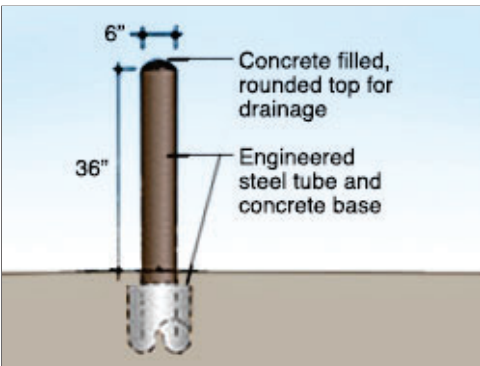



Type: **Building Protection, Steel 2**

Applies to: Group 1 Group 2 Group 3 Group 4 Other

Mfr: Reliance-foundry

Color: Yellow

Finish: Factory

Model #:

Other: Approval needed from COR before specifying yellow bollards

UFGS:

C07.2.6. Bus Shelters

Applicable N/A Number of base standards 1



Type: **1**

Applies to: Group 1 Group 2 Group 3 Group 4 Other

Mfr: Belson Outdoors

Color: Dark Bronze

Finish: Powder coated

Model #: ALS612A2D-12BA, domed roof, double opening

Other: Provide concrete slab and waste receptacle

UFGS: N/A

C07.2.7. Drinking Fountains

Applicable N/A

C07.2.8. Dumpster Enclosures / Gates

Applicable N/A Number of base standards 1



Type: **1: Brick and Steel**

Applies to: Group 1 Group 2 Group 3 Group 4 Other

Mfr: Custom

Color: Brown or Red brick blend (match adjacent building), dark brown doors

Finish: Face brick, powder coated doors

Model #: Match adjacent building

Other: Steel gates and hardware, dark brown, dumpsters shall be painted dark brown. Select brick to match adjacent buildings.

UFGS: Section 04 20 00 Unit Masonry

C07.2.9. Fencing

Applicable N/A Number of base standards 4

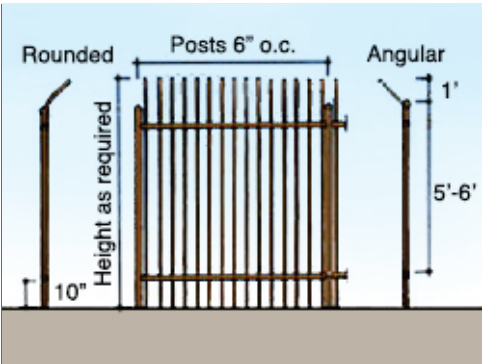

Type: **Style A Barrier: High security, high visibility**

Applies to: Group 1 Group 2 Group 3 Group 4 Other

Mfr: Custom

Color: Dark brown

Finish: Powder coat

Model #: Steel posts, rails and pickets (vertical, bent outward at top)

Other: Posts, rails, and pickets in heights, lengths and gauges as required, (see Appendix for Facility Districts requirements)

UFGS: Section 05 50 13 Miscellaneous Metal Fabrications

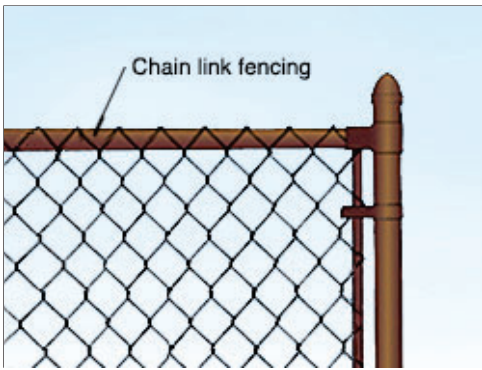

Type: **Style B Barrier: High security, low visibility**

Applies to: Group 1 Group 2 Group 3 Group 4 Other

Mfr: General Wire Co.

Color: Dark brown

Finish: PVC coating over galvanized steel

Model #: Chain link, steel posts and rails, gates and accessories

Other: Around flight line with outriggers, Check with COR for exact requirements..

UFGS: Section 32 31 13 Chain Link Fences and Gates

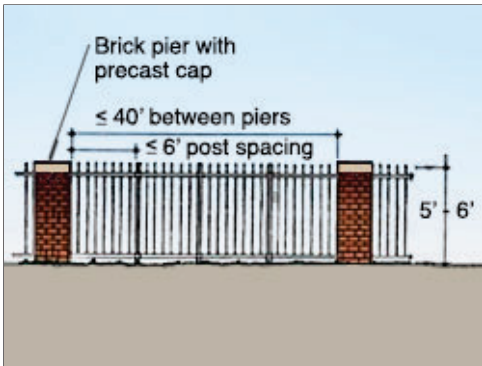

Type: **Style C Barrier: Low security, High visibility**

Applies to: Group 1 Group 2 Group 3 Group 4 Other

Mfr: Custom

Color: Brown or Red brick blend (match adjacent building), beige precast cap

Finish: Face brick, powder coated metal

Model #: Brick Piers with steel posts, rails and pickets

Other: Brick: 2'x2' (Height as required, equally spaced 12' to 40'); Dark bronze fencing: Steel posts: 4"x4" (equally spaced), Rails: 2"x2", Pickets: 1"x1" (6"o.c.); close all ends of tubing

UFGS: Section 04 20 00 Unit Masonry, Section 05 50 13 Misc. Metal

Type: **Style D Barrier (Alternate): Very low security, high visibility**



Applies to: Group 1 Group 2 Group 3 Group 4 Other

Mfr: James Hardie Building Products, Inc.

Color: Off white and Earth tones

Finish: Factory

Model #: Post and rail with vertical boards

Other: Posts: Height as required, 8' max. spacing; apply boards to outside face.

UFGS: Not Available (SECTION 074646 Fiber Cement Siding)

C07.2.10. Flagpoles

Applicable N/A Number of base standards 1



Type: **1**

Applies to: Group 1 Group 2 Group 3 Group 4 Other

Mfr: Eder Flag

Color: Natural aluminum

Finish: Satin Lustre

Model #: ECL30 IH, Internal Halyard

Other: 5" Butt Dia. 33' H (30' Exposed)

UFGS: N/A

C07.2.11. Lighting – Landscape / Accent

Please refer to the Lighting section.

C07.2.12. Litter and Ash Receptacles

Applicable N/A Number of base standards 2



Type: **Style 1: Precast concrete**

Applies to: Group 1 Group 2 Group 3 Group 4 Other

Mfr: Belson

Color: Natural stone, brown

Finish: Textured

Model #: R18SU

Other: Rigid plastic internal liner

UFGS: N/A

Type: **Style 2: Metal**

Applies to: Group 1 Group 2 Group 3 Group 4 Other

Mfr: Belson

Color: Black or as approved

Finish: Powder coat

Model #: Round, slatted

Other: Rigid plastic internal liner

UFGS: N/A



C07.2.13. Picnic Tables

Applicable N/A Number of base standards 2



Type: **Precast concrete**

Applies to: Group 1 Group 2 Group 3 Group 4 Other

Mfr: Belson Outdoors

Color: Brick Red Top/Seats | Buff Frame

Finish: Standard Finish (Smooth)

Model #: TF312012

Other: N/A

UFGS: N/A



Type: **Metal, vinyl coated**

Applies to: Group 1 Group 2 Group 3 Group 4 Other

Mfr: Fifthroom

Color: Brown or as approved

Finish: Factory vinyl coated

Model #: Surface Mount, 46" Square Pedestal Tables with 4 Seats

Other: Perforated Pattern

UFGS: N/A

C07.2.14. Planters

Applicable N/A Number of base standards 1



Type: **Precast concrete**

Applies to: Group 1 Group 2 Group 3 Group 4 Other

Mfr: designcast

Color: Gray

Finish: Smooth

Model #: Classic Series Square Planters

Other: <http://www.designcastusa.com/concrete-landscape-planters.html>

UFGS: N/A

C07.2.15. Play Equipment

Applicable N/A Number of base standards 1



Type: **Steel**

Applies to: Group 1 Group 2 Group 3 Group 4 Other

Mfr: njplaygrounds.com

Color: Varies

Finish: Powdercoated Steel

Model #: Fort Towers

Other: Coordinate with Base Architect

UFGS: N/A

C07.2.16. Screen Walls

Applicable N/A Number of base standards 2



Type: **Brick / Steel**

Applies to: Group 1 Group 2 Group 3 Group 4 Other

Mfr: Custom

Color: Red or brown brick (match adjacent building), dark brown fencing

Finish: Face brick, powder coated metal

Model #: Brick piers with steel posts, rails and alternating panels

Other: Brick: 2'x2' (Height as required, equally spaced 8' to 40'), Steel posts: 4"x4" (equally spaced), Rails: 1-1/4"x1-1/2", vertical steel panels spaced alternately on each side of the rails; matching gates; close all ends

UFGS: Section 04 20 00 Unit Masonry, Section 05 50 13 Misc. Metal

Type: **Steel**

Applies to: Group 1 Group 2 Group 3 Group 4 Other

Mfr: Custom

Color: Dark bronze

Finish: Powder coated metal

Model #: Steel posts, rails and alternating panels

Other: Steel posts: 3"x3" (equally spaced), Rails: 1-1/2"x1-1/2", vertical steel hat channels spaced alternately on each side of the rails; matching gates; close all ends

UFGS: Section 05 50 13 Miscellaneous Metal Fabrications



C07.2.17. Tree Grates

Applicable N/A Number of base standards 1



Type: **Cast Iron**

Applies to: Group 1 Group 2 Group 3 Group 4 Other

Mfr: Neenah Enterprises, Inc.

Color: Natural cast iron

Finish: Cast

Model #: 2-Piece, round or square

Other: N/A

UFGS: N/A

C07.2.18. Other

Applicable N/A

C08. EXTERIOR SIGNS

Comply with AF Corporate Standards for Site Development:

<http://afcfs.wbdg.org/site-development/index.html>

Comply with AF Corporate Standards for Exterior Signs:

<http://afcfs.wbdg.org/site-development/exterior-signs/index.html>

C08.1. Colors and Types

Applicable N/A Large graphics

Applicable N/A Small graphics

1. Provide concise functional signs as a visually unifying element with consistent colors and types for all Installation and Gate Identification Signs; Building Identification Signs; Traffic Control Devices; Directional and Wayfinding Signs; and Informational and Motivational Signs.

2. Provide signs with the lowest overall life cycle costs considering initial cost, ongoing maintenance and lifespan while meeting quality standards. Follow IFS for specifications appropriate for the local climate to withstand weathering.

3. Reduce the number of signs, reduce visual clutter and provide only essential signs required for identification, directions, instructions, and customer service following UFC 3-120-01. Remove non-conforming signs during renovation projects.

4. Use clear concise terms for content consistent with UFC 3-120-01.

5. Display of emblems on building exterior walls or other permanent structures is prohibited by UFC.
6. Raised "standout" letters and numbers may be used for Group 1 with approval on a case basis.
7. Group 2 and 3 facilities shall have wall mounted facility signs with sizes and layouts following UFC 3-120-01. Signs are not permitted for Group 4 facilities.
8. Only one identification sign is permitted at each building entrance. Include a building address consistent with US Postal Service protocols following UFC 3-120-01.
9. Traffic Control Devices, which regulate vehicular traffic on the installation, shall conform to the standards in the Manual of Uniform Traffic Control Devices (MUTCD) published by the Federal Highway Administration. Coordinate street signs with this IFS.
10. Provide Directional and Wayfinding Signs and address both pedestrian and vehicular traffic following UFC 3-120-01 for size, layout and content.
11. Reserved parking signs should be kept to a minimum. When approved, provide post-mounted sign faces in base standard materials and colors. Consider "bracketing" a designated area with a single sign at each end.
12. Parking lot identification signs may be used to identify areas or rows within large lots.
13. Follow the guidelines and requirements in ABAAS and the MUTCD for accessible parking signs.
14. Follow UFC 3-120-01 for Informational and Motivational Signs for size, layout and content.
15. Symbols or pictographs (graphic expressions of actual objects) may be used to indicate service, mandatory / prohibitory, sports, and recreation when rapid communication is necessary.
16. Force Protection signage may be applied to glass doors using white vinyl lettering.
17. Refer to UFC 3-120-01 for prohibited signs, which include those with animated, blinking, chasing, flashing, or moving effects.
18. Manufacturers listed below are only provided to establish a baseline of equivalency among all applicable manufacturers.

C08.1.1. Materials and Color Specifications

Applicable N/A Large graphics

Applicable N/A Small graphics

1. Fabricate sign panels from aluminum, painted brown. Sign posts shall be 3" square aluminum with capped ends in a concrete base.
2. Fence mounted sign panels may be attached with exposed fasteners.
3. Freestanding signs shall have white letters on brown background. Finish shall be fluoropolymer (e.g. Kynar 500) coating or equal.
4. All signage shall follow Federal Highway Administration (FHWA) Manual on Uniform Traffic Control Devices (MUTCD) using standard colors. Refer to MUTCD color specifications, which provide cross-referenced Pantone Matching System (PMS) numbers.
 - a. Standard Blue
 - b. Standard Dark Bronze (also Federal Standard Color 30040)
 - c. Standard Red
 - d. Standard Black (non-reflective)
 - e. Standard White
 - f. Standard Brown
 - g. Standard Yellow

- h. Standard Orange
- i. Standard Green

Materials and Color Specifications

Applicable N/A Number of base standards 3



Type: **Typical Sign Fce**

Applies to: Group 1 Group 2 Group 3 Group 4 Other

Mfr: Custom

Color: Medium bronze

Finish: Matte vinyl

Model #: Aluminum flat sheet

Other: Mount to square posts. Provide sizes following UFC.

UFGS: Section 05 50 13 Miscellaneous Metal Fabrications

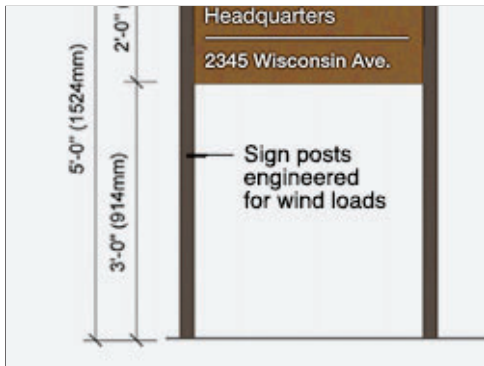

Type: **Typical Sign Post**

Applies to: Group 1 Group 2 Group 3 Group 4 Other

Mfr: Custom

Color: Dark bronze, powder coat finish

Finish: Matte

Model #: Extruded aluminum with capped top ends

Other: Square posts and squared ends. Provide engineered sizes.

UFGS: Section 05 50 13 Miscellaneous Metal Fabrications

Type: **Typical Sign Base**

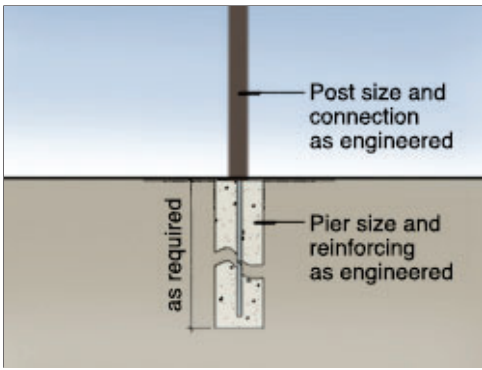

Applies to: Group 1 Group 2 Group 3 Group 4 Other

Mfr: Custom

Color: Natural Gray

Finish: Sonotube-formed

Model #: 24" height x 12" diameter, as engineered.

Other: At grade with 3/4" chamfer. Provide engineered sizes.

UFGS: UFGS 03 30 00 Cast-in-place Concrete

C08.1.2. Installation and Gate Identification Signs

Applicable N/A Number of base standards 1



Type: **Primary, Secondary and Tertiary (Uses per UFC)**

Applies to: Group 1 Group 2 Group 3 Group 4 Other

Mfr: Custom

Color: Dark bronze, brushed aluminum, accents per UFC

Finish: Powder coat or vinyl sign face

Model #: Metal frame and panels, buff stone base

Other: White vinyl lettering. Provide dimensions per UFC. Secondary signs shall match primary sign's materials, but shall be smaller in size per UFC. Tertiary signs shall follow the UFC.

UFGS: Section 05 50 13 Miscellaneous Metal Fabrications

C08.1.3. Building Identification Signs

Applicable N/A Number of base standards 4

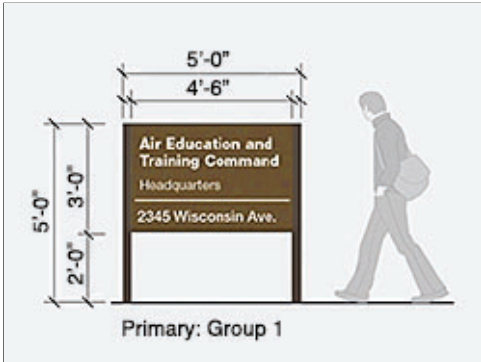

Type: **Freestanding Primary Sign (Sizes and Uses per UFC)**

Applies to: Group 1 Group 2 Group 3 Group 4 Other

Mfr: Custom

Color: Medium brown face, dark bronze posts, white vinyl lettering

Finish: Powder coat or vinyl sign face

Model #: Aluminum sheet face, extruded aluminum posts

Other: Provide layout and sizes per UFC.

UFGS: Section 05 50 13 Miscellaneous Metal Fabrications

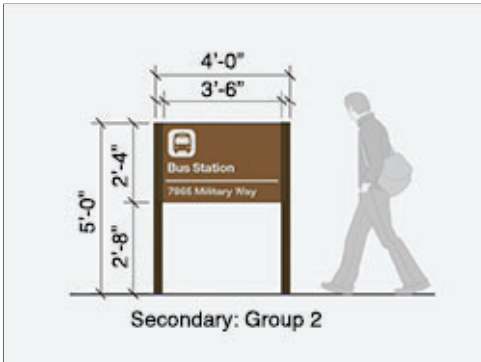

Type: **Freestanding Secondary Sign (Sizes and Uses per UFC)**

Applies to: Group 1 Group 2 Group 3 Group 4 Other

Mfr: Custom

Color: Medium brown face, dark bronze posts, white vinyl lettering

Finish: Powder coat or vinyl sign face

Model #: Aluminum sheet face, extruded aluminum posts

Other: Provide layout and sizes per UFC.

UFGS: Section 05 50 13 Miscellaneous Metal Fabrications

Type: **Freestanding Tertiary Sign (Sizes and Uses per UFC)**

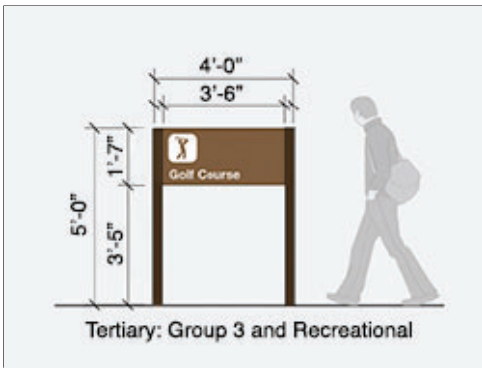

Applies to: Group 1 Group 2 Group 3 Group 4 Other

Mfr: Custom

Color: Medium brown face, dark bronze posts, white vinyl lettering

Finish: Powder coat or vinyl sign face

Model #: Aluminum sheet face, extruded aluminum posts

Other: Provide layout and sizes per UFC.

UFGS: Section 05 50 13 Miscellaneous Metal Fabrications

Type: **Wall Mounted**

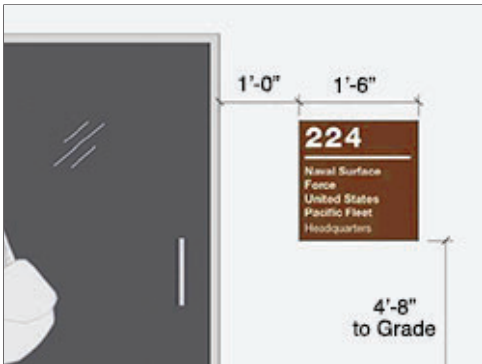

Applies to: Group 1 Group 2 Group 3 Group 4 Other

Mfr: Custom

Color: Medium brown, white lettering

Finish: Satin vinyl applied to aluminum sheet

Model #: Aluminum sheet with vinyl face and vinyl lettering

Other: Provide layout and sizes following UFC.

UFGS: N/A

C08.1.4. Traffic Control Devices (Street Signs)

Applicable N/A Number of base standards 1



Type: **Street Signs**

Applies to: Group 1 Group 2 Group 3 Group 4 Other

Mfr: Custom

Color: White reflective lettering on a Standard Brown background

Finish: Powder coat or vinyl sign face

Model #: Aluminum sign face, control arm or pole mounted

Other: Mount 7' above grade minimum, pictographs and logos are prohibited on street name signs per UFC.

UFGS: Section 05 50 13 Miscellaneous Metal Fabrications

C08.1.5. Directional and Wayfinding Signs

Applicable N/A Number of base standards 2



Type: **Vehicular**

Applies to: Group 1 Group 2 Group 3 Group 4 Other

Mfr: Custom

Color: Medium brown face, dark bronze posts, white reflective lettering

Finish: Powder coat or vinyl sign face

Model #: Aluminum sheet face, extruded aluminum posts

Other: Conform to the requirements of the MUTCD and its DoD Supplement. Provide types and sizes where required by UFC.

UFGS: Section 05 50 13 Miscellaneous Metal Fabrications

Type: **Pedestrian**

Applies to: Group 1 Group 2 Group 3 Group 4 Other

Mfr: Custom

Color: Medium brown face, dark bronze posts

Finish: Powder coat or vinyl sign face

Model #: Aluminum sheet face, extruded aluminum posts

Other: White vinyl lettering. Provide types and sizes where required by UFC.

UFGS: Section 05 50 13 Miscellaneous Metal Fabrications

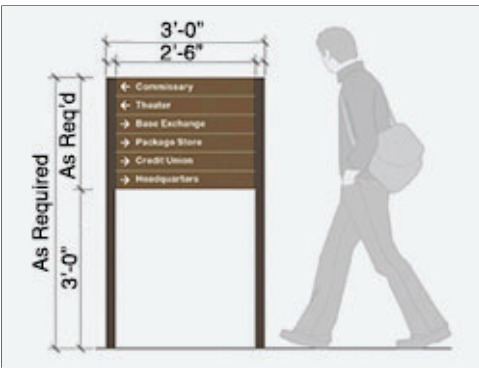

C08.1.6. Informational Signs

Applicable N/A Large graphics

Applicable N/A Small graphics

1. Minimize informational signs such as static display signs, hours of operation, and project signs to reduce visual clutter.
2. Static display signs shall have standard brown background with white lettering.
3. Hours of operation signs shall have a level of quality equivalent to the Facility Group number.
4. Temporary / Project Signage shall be judiciously placed to avoid visual clutter. Schedule and arrange for the removal of these signs prior to installation.

C08.1.7. Motivational Signage

Applicable N/A Large graphics

Applicable N/A Small graphics

1. Provide professionally produced motivational signs as important elements of campaigns to boost morale, improve safety, aid in recruiting, and accomplish other motivational objectives. Consolidate this signage to reduce visual clutter.
2. Motivational signs shall be limited to an electronic "marquee" type changeable sign near each gate. Temporary signs are not permitted. Motivational information may also be posted in a small, printed format on kiosks in specified, high pedestrian use areas. Refer to kiosks under Site Furnishings.
3. Follow UFC 3-120-01 for color and layout. Note that animated, blinking, chasing, flashing, or moving effects are prohibited by the UFC.
4. Mount marquee signs on reinforced concrete bases with a natural warm gray color.

C08.1.8. Parking Lot Signs

Applicable N/A

C08.1.9. Regulatory Signs

Applicable N/A

1. Regulatory signage, which restricts, warns and advises, shall be limited to those mandated under Highway/Traffic, Government Warning, and/or Parking Regulation. Follow UFC 3-120-01 and its industry references for color and layout.
2. Provide a comprehensive, systematic approach to regulatory signage to avoid clutter and confusion from “over signage.”
3. Maintain base warning signs for safety and security at the base perimeter and at specific secure areas. Use these to notify visitors of restrictions governing conduct on the base, as well as other security procedures.

C08.1.10. Other

Applicable N/A

C09. LIGHTING

Comply with AF Corporate Standards for Site Development:
<http://afcs.wbdg.org/site-development/index.html>

Comply with AF Corporate Standards for Lighting:
<http://afcs.wbdg.org/site-development/lighting/index.html>

C09.1. Fixtures and Lamping

Applicable N/A Large graphics

Applicable N/A Small graphics



Street Light Pole and Fixture



Street Light Globe



Accent Lighting Fixture

1. Provide, coordinate and efficiently install street, parking lot, sidewalk and facility lighting with appropriate luminaires, lamping, placement and spacing following UFC 3-530-01 and Installation Facilities Standards (IFS); ensure the level of quality is consistent with the adjacent facility group number. Pole-mounted, wall-mounted and bollard fixtures are permitted.
2. Integrate controls to automatically reduce lighting power during periods of non-activity; automatically turn off power when sufficient daylight is available.

3. Ensure continuity and consistency of lighting elements. In new construction generally match post types, fixture types, styles, heights, sizes, materials, colors, and lamp types of adjacent facilities and the facility district.
4. Economically provide renewable-energy power sources such as solar photovoltaic when feasible.
5. Use appropriately designed or shielded luminaires to direct light downward to minimize light pollution and intrusion onto adjacent sites and to facilitate night training.
6. Calculate illuminant levels for all lighting applications following UFC 3-530-01 and ensure compliance with pre-curfew maximum brightness level requirements.
7. Sufficiently address environmental factors to prevent corrosion and weathering of fixtures, plinths and other components.
8. Wall mounted fixtures should respond to the architectural character of the facility.
9. Efficient accent lighting of architectural and landscape features may be provided for Group 1, lodging and historical applications. Accent lights in ground-mounted locations may be provided for static displays and signs when these do not conflict or cause hazards with overhead aircraft.
10. Comply with UFC 3-530-01 for light source technology and lamp types. High efficiency lamping such as LED is preferred for most applications.
11. Provide round tapered, square non-tapered, or round non-tapered aluminum poles and aluminum fixtures with square, rectangular or circular housings in colors and shapes to match adjacent facilities and the facility district.
12. Install lighted bollards only at Group 1 and high-traffic Group 2 facilities. Generally match materials, colors and shapes of adjacent facilities and the facility district.
13. Install natural warm gray color, smooth finished concrete bases for all poles in heights appropriate for the facility group and application. Generally Groups 1, 2 and 4 shall have at-grade bases. Group 3 shall have taller bases for added durability.
14. When parking lot lighting is necessary, provide an illuminated path to the building's main entrance. Pole bases should be contained within an internal landscape median or island.
15. Consistently install lighting for sidewalks, bikeways and trails to match adjacent facilities.
16. Landscape accent lighting may be used in public gathering spaces and in Group 1 facilities. Coordinate the design, luminaire selection, and placement with the location of trees, shrubs, and site furnishings.
17. Manufacturers listed below are only provided to establish a baseline of equivalency among all applicable manufacturers.

C09.2. Light Fixture Types

Note: Apply the below base-wide standards for Light Fixtures (products, materials and color). Then refer to the Appendix and apply any additional requirements specifically related to the Facility District in which the project is located.

C09.2.1. Street Lighting

Applicable N/A Number of base standards 1



Type: **Style 1**

Applies to: Group 1 Group 2 Group 3 Group 4 Other

Mfr: TBD

Color: Dark Bronze Anodized (or Clear Anodized as approved by BCE)

Finish: Factory

Model #: Round with glass globe and metal shroud

Other: Lamp: LED. Follow manufacturer's recommendations for fixture base.

UFGS: N/A

C09.2.2. Parking Lot Lighting

Applicable N/A Number of base standards 2

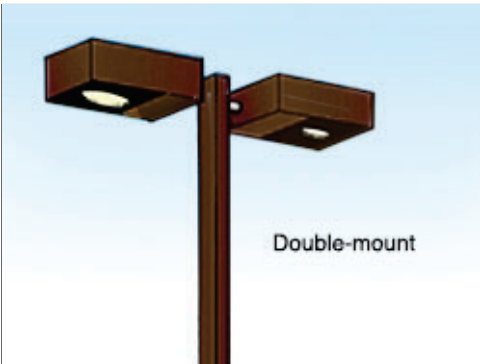

Type: **Parking Lot Style 1**

Applies to: Group 1 Group 2 Group 3 Group 4 Other

Mfr: Hubbell, Kim Lighting

Color: Dark Bronze Anodized (or Clear Anodized as approved by BCE)

Finish: Factory

Model #: Rectilinear or Round Cutoff, Single Arm or Dual Arm Mount

Other: Lamp: LED. Follow manufacturer's recommendations for fixture base.

UFGS: N/A

Type: **Parking Lot Fixture Base**

Applies to: Group 1 Group 2 Group 3 Group 4 Other

Mfr: Custom

Color: Natural gray

Finish: Trowel

Model #: Form-cast, round

Other: N/A

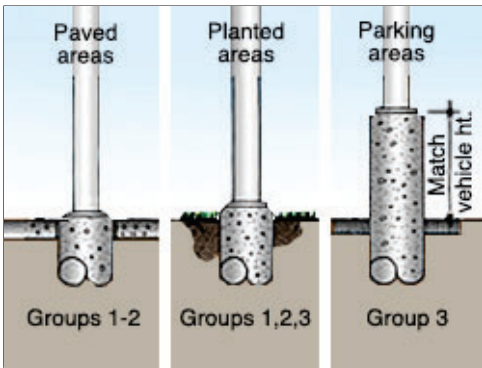

UFGS: Section 03 33 00 Cast-In-Place Architectural Concrete

C09.2.3. Lighted Bollards

Applicable N/A Number of base standards 1



Type: **Lighted Round Dome Top**

Applies to: Group 1 Group 2 Group 3 Group 4 Other

Mfr: Lithonia Lighting Products

Color: Dark Bronze

Finish: Anodized aluminum

Model #: KBA

Other: Flared cone, 3000K LED Lamp. Follow manufacturer's recommendations for fixture base.

UFGS: N/A

C09.2.4. Sidewalk Lighting

Applicable N/A Number of base standards 1

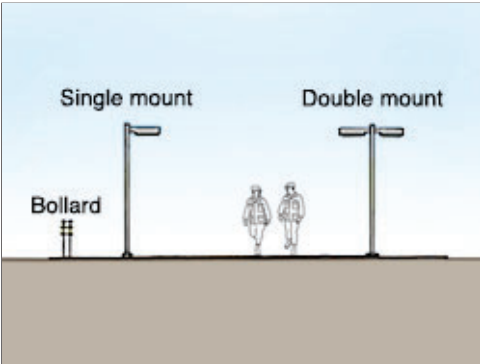

Type: **Rectilinear Cutoff**

Applies to: Group 1 Group 2 Group 3 Group 4 Other

Mfr: Hubbell, Kim Lighting

Color: Dark Bronze Anodized (or Clear Anodized as approved by BCE)

Finish: Anodized aluminum

Model #: Rectilinear Cutoff, Single Arm or Dual Arm Mount

Other: Lamp: LED. Follow manufacturer's recommendations for fixture base.

UFGS: N/A

C09.2.5. Walls / Stairs Lighting

Applicable N/A Number of base standards 1



Type: **Style 1**

Applies to: Group 1 Group 2 Group 3 Group 4 Other

Mfr: Vista Lighting

Color: Dark bronze anodized

Finish: Smooth

Model #: Aluminum Step and Brick Lights, 5230 round louvered

Other: Lamp: LED

UFGS: N/A

C09.2.6. Other

Applicable N/A

D. FACILITIES EXTERIORS

Comply with Air Force Corporate Standards for Facilities Exteriors:

<http://afcfs.wbdg.org/facilities-exteriors/index.html>

Applicable N/A Large graphics

Applicable N/A Small graphics

D01. SUPPORTING THE MISSION

Comply with AF Corporate Standards for Supporting the Mission:

<http://afcfs.wbdg.org/facilities-exteriors/supporting-the-mission/index.html>

D02. SUSTAINABILITY

Comply with Air Force Corporate Standards for Sustainability:

<http://afcfs.wbdg.org/facilities-exteriors/supporting-the-mission/index.html>

D03. ARCHITECTURAL FEATURES

Comply with AF Corporate Standards for Facilities Exteriors:
<http://afcs.wbdg.org/facilities-exteriors/index.html>

Comply with AF Corporate Standards for Architectural Features:
<http://afcs.wbdg.org/facilities-exteriors/architectural-features/index.html>

Group 1



Group 2



Group 3



Group 4



D03.1. Orientation, Massing and Scale

1. Orient new buildings to maximize energy efficiency, passive solar and daylighting potential of the building; narrow buildings oriented along an east-west axis are preferred to minimize heat gain in the summer months and maximize heat gain in the winter months resulting in less overall energy usage.
2. Provide orthogonal geometry for principal building form; angular geometry may be used sparingly for Group 1 and used only for emphasis at specific areas such as building entrances and stairwells.
3. Maintain a human scale and reduce the visual scale of large buildings with sub-massing related to interior functional operations; create consistent form and scale in adjacent buildings with compatible profiles or silhouettes.
4. Building heights shall not be limited; however, building heights over 2 stories shall be considered on a case basis.
5. Combine functions where practical to avoid a proliferation of small, independent structures.
6. Use and coordinate shading devices with orientation and for function.

D03.2. Architectural Character

1. Develop architectural features, materials and detailing appropriate for the Facility Group designation. Refer to Building Entrances, Wall Systems and Roof Systems.
2. Respond to the local climate and regional influences with environmentally functional architectural features.
3. For new facilities design generally maintain consistency and visual unity in the character of the adjacent buildings through compatible architectural features: repeated use of similar forms such as roofs, and through recurring elements such as doors, windows, materials and colors.
4. Develop facades with proportions and a tripartite (base-middle-top) organization for compatibility with the historic architecture without direct stylistic imitation. Newly designed porticos, arcades or colonnades, for example, should avoid directly repeating features found on historic buildings.
5. Reinforce the campus atmosphere with human scaled architectural features and elements. Ensure a professional appearance with an image of quality and permanence.
6. All facilities shall express sustainability through their orientation, massing, shape, form, materials, and detailing. Provide louvers, fins and other shading devices to control heat gain and glare and to and improve energy efficiency.
7. Use simple forms for large industrial buildings with sub-massing to provide a human scale.
8. Strive for economical construction without compromising a high-quality, professional appearance.

D03.3. Details and Color

1. Provide a palette of earth-tone colors related to the native landscape in brick, block, stucco and powder-coated metals. Refer to wall systems for detailed material listings.
2. Relate the level of architectural detailing to the Facility Group number.
3. Use only integrally colored materials as the predominant exterior building material; do not use materials that require field painting and ongoing maintenance.
4. Provide consistent and compatible colors for every exterior building feature, including walls, roofs, doors, windows, gutters, downspouts, utility and mechanical elements, and other visible elements.
5. Noncorrosive metals with factory applied color finishes are required.
6. Combine details and color with orientation, massing, scale and architectural character to maintain base compatibility.
7. High visibility areas may require Anti-terrorism force protection measures, Check with COR for requirements.

7. Manufacturers listed below are only provided to establish a baseline of equivalency among all applicable manufacturers.

D03.3.1. Climate-based Data and Life-Cycle Cost-Effective Passive and Natural Design Strategies:

- Climate dominated by mechanical cooling
- Climate dominated by mechanical heating
- Climate with similar mechanical cooling / heating needs
- Climate with minimal mechanical cooling / heating needs

- Climate with high humidity
- Climate with moderate humidity
- Climate with low humidity

- High Solar Insolation
- Moderate Solar Insolation
- Low Solar Insolation

- Soils with High Thermal Conductivity
- Soils with Average Thermal Conductivity
- Soils with Low Thermal Conductivity

Other: Consider the potential for flooding and corrosion.

Other:

Facility: Narrow buildings along E-W axis are preferred

Wall: Integral shading features and devices

Doors: Recessed are preferred

Windows: Limit non-shaded windows / maximize windows on south façades with shading

Roof: High to medium albedo, minimal to moderate slope

Structure: Do not exposed ferrous metals. Provide factory finished non-ferrous metals or concrete

MEP: Ground-source and solar photovoltaic (with prior approval) following LCCA

Other: Provide shading devices primarily on west exposures

Other: Internal thermal mass walls may be used following LCCA

Note: Apply the below base-wide standards for Architectural Features (products, materials and color). Then refer to the Appendix and apply any additional requirements specifically related to the Facility District in which the project is located.

D03.3.2. Natural Ventilation System

Applicable N/A Number of base standards 3



Type: **Style 1 Aluminum Windows**

Applies to: Group 1 Group 2 Group 3 Group 4 Other

Mfr: Kawneer (or equivalent)

Color: Medium Bronze

Finish: Anodized

Model #: 2x4, Awning type

Other: Provide thermally broken frames.

UFGS: Section 08 51 13 Aluminum Windows



Type: **Style 2 Steel Windows**

Applies to: Group 1 Group 2 Group 3 Group 4 Other

Mfr: Steelcraft (or equivalent)

Color: Medium Bronze

Finish: Powder coated

Model #: 2x4 frame, Casement type

Other: Provide thermally broken frames

UFGS: Section 08 51 13 Aluminum Windows



Type: **Double Hung**

Applies to: Group 1 Group 2 Group 3 Group 4 Other

Mfr: Pella

Color: White

Finish: Vinyl

Model #:

Other:

UFGS: Section 08 53 00 Plastic windows

D03.3.3. Thermal Mass

Applicable N/A Number of base standards 1



Type: **Style 1 Interior Wall Material**

Applies to: Group 1 Group 2 Group 3 Group 4 Other

Mfr: Custom, TBD

Color: Match exterior masonry

Finish: Light texture

Model #: Modular Face Brick, coursed unit masonry

Other: Provide only per LCCA following UFC 1-200-02.

UFGS: Section 04 20 00 Unit Masonry

D03.3.4. Thermal Shading

Applicable N/A Number of base standards 2



Type: **Style 1 Wall Devices**

Applies to: Group 1 Group 2 Group 3 Group 4 Other

Mfr: Kawneer (or equivalent) or custom

Color: Medium bronze

Finish: Factory, to match frames

Model #: Louver

Other: Shading devices may be attached to frames. Shading devices may be attached to structure. Provide only per LCCA following UFC 1-200-02.

UFGS: Section 08 41 13 Aluminum-Framed Entrances and Storefronts

Type: **Style 2 Wall Devices**

Applies to: Group 1 Group 2 Group 3 Group 4 Other

Mfr: Steelcraft (or equivalent)

Color: Medium bronze

Finish: Factory, to match frames

Model #: Louver, powder coated

Other: Shading devices may be attached to frames. Shading devices may be attached to structure. Provide only per LCCA following UFC 1-200-02.

UFGS: Section 08 11 13 Steel Doors and Frames



D03.3.5. Renewable Heating/Cooling

Applicable N/A Number of base standards 1

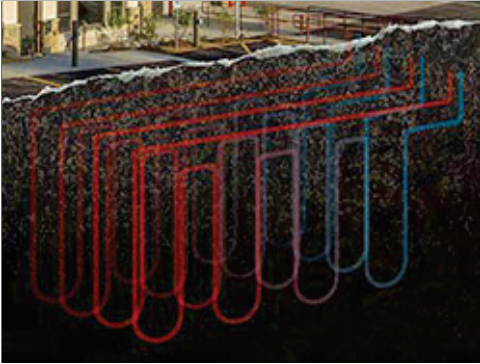

Type: **Style 1 Geothermal (Ground Source)**

Applies to: Group 1 Group 2 Group 3 Group 4 Other

Mfr: Climate Master

Color: N/A

Finish: N/A

Model #: N/A

Other: Vertical ground loop well field

UFGS: Section 23 81 47 Water-Loop and Ground-Loop Heat Pump Systems

D03.3.6. Solar Photovoltaic System

Applicable N/A Number of base standards 1



Type: **Style 1: Roof Mounted Array**

Applies to: Group 1 Group 2 Group 3 Group 4 Other

Mfr: Varies

Color: Factory

Finish: Factory

Model #: Flat panel, moderate insolation

Other: Ground mount or roof mount

UFGS: UFGS: Section 26 31 00 Solar Photovoltaic (PV) Components

D03.3.7. Solar Thermal System

Applicable N/A Number of base standards 1



Type: **Style 2: Wall Mounted Array**

Applies to: Group 1 Group 2 Group 3 Group 4 Other

Mfr: Varies

Color: Factory

Finish: Factory

Model #: Flat panel, moderate insolation

Other: Ground mount or roof mount

UFGS: Section 48 14 13.00 20 Solar Liquid Flat Plate and Evac. Tube Collectors

D04. BUILDING ENTRANCES

Comply with AF Corporate Standards for Facilities Exteriors:

<http://afcfs.wbdg.org/facilities-exteriors/index.html>

Comply with AF Corporate Standards for Building Entrances:

<http://afcfs.wbdg.org/facilities-exteriors/building-entrances/index.html>

Group 1



Group 2



Group 3



Group 4



D04.1. Primary Entrances

1. Emphasize the primary entrance in the overall building design with a projecting or recessed covering for weather protection following Installation Facilities Standards (IFS) for Facility Group designations.
2. Provide vestibules at entries in Groups 1, 2 and 3 unless used infrequently or serving unconditioned space following ASHRAE 90.1.
3. Fully integrate all elements including the design of handicap ramps in the overall design of the primary entrance in an organized uncluttered appearance.
4. Install paved transitional spaces sized for the building function and occupancy. Use accent pavers in approach walkways or at entry plazas.
5. Install appropriate lighting and site furniture following ATFP and IFS.
6. Protect entrances in cold climates from falling ice and snow.
7. Provide porte cocheres or covered drop-offs when justified for lodging and medical facilities; do not use for prestige or architectural accents. Integrate ATFP requirements.
8. Locate newspaper, vending machines and similar elements out of view to avoid visual clutter.

D04.2. Secondary Entrances

1. Provide vestibules at entries in Groups 1, 2 and 3 unless used infrequently or serving unconditioned space following ASHRAE 90.1; use of stair towers as vestibules for multi-story buildings is encouraged when building and / or energy codes are satisfied.
2. Reflect the character of the primary entrance to a lesser extent with a smaller scale.
3. Include a recess or projection for weather protection and shading.
4. Integrate service and egress doors and loading areas with the building design by matching the materials and detailing and reflect the overall quality of the facility.
5. Incorporate egress structures such as stair towers into the facility design.
6. Canopies may be used for service and loading areas; weather protection beyond weatherstripping is not required at doors used only for life safety egress.
7. Develop building massing and orientation to minimize the appearance of service and loading areas; physically and visually separate these from primary entrances.
8. Loading areas must be organized, orderly and have an uncluttered appearance.

D05. WALL SYSTEMS

Comply with AF Corporate Standards for Facilities Exteriors:

<http://afcs.wbdg.org/facilities-exteriors/index.html>

Comply with AF Corporate Standards for Doors and Windows:

<http://afcs.wbdg.org/facilities-exteriors/wall-systems/index.html>

Comply with AFCFS Recommended Materials:

<http://afcs.wbdg.org/facilities-exteriors/wall-systems/materials/index.html>

Group 1



Group 2



Group 3

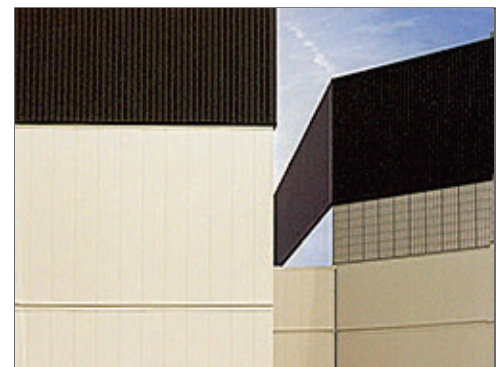

Group 4



D05.1. Hierarchy of Materials

1. Group 1 facilities may have more refined detailing than Group 2 and Group 2 may have more definition than Group 3.
2. Group 1 and 2 facilities shall be predominantly brick; secondary accent materials will be architectural precast concrete. Generally match the size, color and texture of brick and precast of adjacent facilities in new construction.
3. Detailed designs and patterns may be cast into the pieces to create an individual character for a single facility or complex.
4. EIFS is permitted in group 1,2 & 3 with approval of ACRB
5. Red brick is permitted in the special use area near the Base Chapel with ACRB approval.
6. Brick may be used when appropriate for Lintels, sills, or arches. Detailing should emulate bearing wall construction. Conceal expansion joints with down spouts or locate them at transitions in the wall such as at pilasters or reveals. Efflorescence in masonry work is unacceptable. Measures must be provided to prevent it.
7. Ribbed metal sheeting is the predominant material for Group 3 facilities and inconspicuous areas of Group 2 facilities. Brick accents may be provided in Group 3 as wainscots where added durability is required or where facilities are adjacent to a Group 1 arterial street. Generally match the size, color and texture of metal panels and brick of adjacent facilities in new construction.
8. Group 4 shall be a combination of brick and horizontal siding: Use trim and accent colors that are compatible with the field colors and that highlight significant building features. Check with privatization team or contracting officer Representative (COR) for further information.
9. Match the existing wall materials for addition / alteration projects unless a significant change to the exterior envelope is included.
10. Multi-story Group 1 facilities may include a transition in material, color or detailing to create a visual base. Generally limit cast stone banding to a single color on Group 2, 3 and 4 facilities.
11. Use high-performance building envelopes.
12. In renovations and repair projects of historic structures follow the guidelines of the State Historic Preservation office. Generally, provide replacement brick matching the color, shape, size, texture, appearance, and thermal expansion properties of the existing historic brick. Match existing mortar color and joint profile shall match existing when brick veneer repairs or additions to existing structures are accomplished.
13. Use detailing not subject to excessive weathering. Provide wall accents consistently throughout the base.
14. Use integrally colored materials and factory-finished metals. Do not paint concrete block.
15. Translucent wall panels may be used in Facility Group 3 when protected from direct solar gain. Provide insulating panels and shading appropriate for the orientation and exposure.
16. Manufacturers listed below are only provided to establish a baseline of equivalency among all applicable manufacturers.

D05.2. Layout, Organization and Durability

1. Organize wall components including doors, windows, accents, shading devices, control joints, etc., to provide an ordered, professional appearance.
2. Integrate shading devices into the overall composition of the wall.
3. Integrate fixed shading devices as at all exterior glazing exposed to summer UV heat gain as a passive design measure to reduce energy use. Ensure adequate shading at west entrances. Deciduous trees may be used for shading.
4. Shading systems may be included as part of a manufacturer's window system or may be custom systems integrated into the wall.

5. Provide appropriate transitions between dissimilar materials to mitigate effects of thermal expansion and galvanic action.
6. All joint sealants shall be slightly darker than adjacent surfaces.
7. Materials requiring regular maintenance are not permitted; do not use exposed structural steel or other materials that require painting.
8. Refer to C07.2.16. Screen Walls for materials and colors of freestanding walls.
9. Refer to D07. Roofs for downspouts.

D05.3. Equipment, Vents and Devices

1. Arrange all mechanical, electrical, fire alarm, lightning protection and other system components to create an orderly appearance that integrates with the wall system.
2. Do not expose conduits, cables, piping, lightning protection components, etc. on exterior walls; if unavoidable in renovations, finish these elements to match the adjacent wall surface.
3. Avoid visual clutter and where surface-mounted elements are required they shall match the wall color.
4. Upon demolition remove any unused, conduits, cables, piping, or other utilities within the project.

D05.4 Wall Systems Materials

Facility Group 1 wall materials shall be as follows.

- Primary: Brick
- Secondary: EFIS
- Accent: Optional: Cast stone

Facility Group 2 wall materials shall be as follows.

- Primary: Brick
- Secondary: EFIS
- Accent: Optional: Cast stone

Facility Group 3 wall materials shall be as follows.

- Primary: Metal Sheeting
- Secondary: Metal Sheeting in Alternate Color or Brick
- Accent: Optional: Brick / cast stone

Facility Group 4 wall materials shall be as follows.

- Primary: Fiber Cement Siding
- Secondary: Fiber Cement Siding, Trim Boards
- Accent: Concrete or Brick Foundation Cladding

Note: Apply the below base-wide standards for Wall Systems (products, materials and color). Then refer to the Appendix and apply any additional requirements specifically related to the Facility District in which the project is located.

D05.4.1. Flat Metal Panels

- Applicable
- N/A

D05.4.2. Brick Veneer

Applicable N/A Number of base standards 2



Type: **Style 1: Brown Brick**

Applies to: Group 1 Group 2 Group 3 Group 4 Other

Mfr: Diener Brick

Model #: #373

Color: Autumn blend

Finish: Wirecut

Other: Nominal size: 4x8x2.6

UFGS: Section 04 20 00 Unit Masonry:
<http://www.wbdg.org/FFC/DOD/UFGS/UFGS 04 20 00.pdf>

Type: **Style 2: Red Brick**

Applies to: Group 1 Group 2 Group 3 Group 4 Other

Mfr: Richtex Corp.

Model #: Shape 223#10A

Color: D-80

Finish: Smooth face

Other: Modular face brick, 4"x 8"x 2.6" nominal

UFGS: Section 04 20 00 Unit Masonry:
<http://www.wbdg.org/FFC/DOD/UFGS/UFGS 04 20 00.pdf>



D05.4.3. Architectural Precast

Applicable N/A Number of base standards 1



Type: **Style 1**

Applies to: Group 1 Group 2 Group 3 Group 4 Other

Mfr: Continental cast stone

Model #: Smooth casting, matches brick coursing

Color: Dark buff limestone

Finish: Very Light texture

Other: N/A

UFGS: Section 03 45 00 Precast Architectural Concrete:
<http://www.wbdg.org/FFC/DOD/UFGS/UFGS 03 45 00.pdf>

D05.4.4. Stucco Over Sheathing

Applicable N/A

D05.4.5. Curtain Wall

Applicable N/A

D05.4.6. Cast-In-Place Concrete

Applicable N/A Number of base standards 1

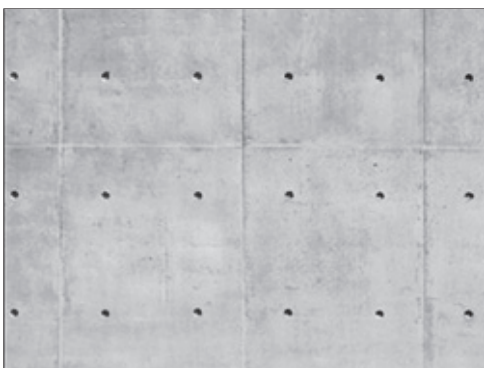

Type: **Style 1**

Applies to: Group 1 Group 2 Group 3 Group 4 Other

Mfr: TBD

Model #: Sheet-formed with exposed-tie reveals

Color: Natural gray with exposed aggregate

Finish: Medium Texture (or media blasted)

Other: N/A

UFGS: Section 03 33 00 Cast-In-Place Architectural Concrete:
<http://www.wbdg.org/FFC/DOD/UFGS/UFGS 03 33 00.pdf>

D05.4.7. Tilt-Up Concrete

Applicable N/A

D05.4.8. Ribbed Metal Sheeting

Applicable N/A Number of base standards 1



Type: **Style 1**

Applies to: Group 1 Group 2 Group 3 Group 4 Other

Mfr: Una-Clad Copper Sales, Inc.

Model #: Series 4000

Color: Wheatsheaf

Finish: Embossed texture, factory finished

Other: 24 Gauge Steel

UFGS: Section 07 42 13 Metal Wall Panels:
<http://www.wbdg.org/FFC/DOD/UFGS/UFGS 07 42 13.pdf>

D05.4.9. EIFS

Applicable N/A Number of base standards 1



Type: **Style 1**

Applies to: Group 1 Group 2 Group 3 Group 4 Other

Mfr: Dryvit

Model #: Sandpebble

Color: Wheatsheaf

Finish: Sand

Other: Confirm class of system with the BCE

UFGS: Section 07 24 00 Exterior Insulation and Finish Systems:
<http://www.wbdg.org/FFC/DOD/UFGS/UFGS 07 24 00.pdf>

D05.4.10. GFRC

Applicable N/A

D05.4.11. Concrete Block

Applicable N/A

D05.4.12. Fiber Cement Siding

Applicable N/A Number of base standards 1



Type: **Style 1**

Applies to: Group 1 Group 2 Group 3 Group 4 Other

Mfr: James Hardie Building Products, Inc.

Model #: Horizontal Lap Siding, Shingle Siding

Color: Earth Tones

Finish: Wood Texture

Other: Hardie Plank, Hardie Shingle

UFGS: SECTION 074646 Fiber Cement Siding:
(Not Available on UFGS)

D05.4.13. Other

Applicable N/A

D06. DOORS AND WINDOWS

Comply with AF Corporate Standards for Facilities Exteriors:

<http://afcfs.wbdg.org/facilities-exteriors/index.html>

Comply with AF Corporate Standards for Doors and Windows:

<http://afcfs.wbdg.org/facilities-exteriors/doors-and-windows/index.html>

Comply with AFCFS Recommended Materials:

<http://afcfs.wbdg.org/facilities-exteriors/doors-and-windows/materials/index.html>

Group 1



Group 2



Group 3



Group 4



D06.1. Types

1. Use anodized dark brown aluminum doors, windows and frames with thermal breaks as preferred for Facility Groups 1-2. Set windows back at least 3" from the building facade; match the color of the door and frame. Anodized finishes shall have a 5-year warranty. For renovation projects the color of new windows, doors and frames may match the existing ones.
2. Exterior doors and frames in Group 3 shall be hollow metal and factory finished with dark brown powder coat. Check with COR.
3. Aluminum clad wood windows are preferred for Facility Group 4.
4. Standard-sized hinged doors are preferred. Use sliding, folding, overhead, sectional and other door configurations only to support mission operations.
5. Automatic doors are allowed only where functionally necessary.
6. Limit hollow metal doors and frames to security doors, utility rooms and mechanical rooms in Groups 1 and 2 and to any application in Group 3 facilities; should be galvanized and factory powder coated finished dark brown.
7. Passive thermal comfort methods of ventilation are encouraged where life cycle cost justified. Provide operable windows in residential, educational, and administrative spaces when possible. Specify insect screens and accessible hardware on operable windows.
8. Windows must meet force protection requirements.
9. Adjacent joint sealants should be slightly darker than the frame color.
10. For historic buildings the style and profile of new and/or replacement windows shall match the original window (consult the base Cultural Resource Management Plan (CRMP). The use of painted wood is discouraged, it is preferred that frames, molding and trim are wood clad in pre-finished aluminum. When retrofit storm windows are selected, provide units that compliment the existing window.
11. Manufacturers listed below are only provided to establish a baseline of equivalency among all applicable manufacturers.

D06.2. Layout and Geometry

1. Visually and functionally compose openings in walls for the climate-specific exposure.
2. Consistently use opening type, size, placement, mullion pattern, and color to reinforce the overall architectural design.
3. Openings shall augment interior lighting and space conditioning needs.
4. Protect against vandalism, intrusion and coordinate sound ratings.
5. Use north facing clerestory windows and other natural lighting methods to reduce lighting demand and associated cooling load.

D06.3. Glazing and Shading

1. Bronze tinted, insulated, energy-efficient, low-e, double-pane glazing with minimum reflectance is encouraged; provide triple-pane glazing in extreme environments.
2. Glazing color shall follow Installation Facilities Standards (IFS).
3. Translucent wall panels may be integrated into wall systems.
4. Do not use mirrored glazing.
5. Where appropriate, install window screens to take advantage of natural ventilation.

D06.4. Hardware

1. All locks at JBMDL McGuire shall be compatible with Best Grand Master locking system. Hardware shall meet the requirements of the Americans with Disabilities Act Accessibility Guidelines in all community buildings and public buildings.
2. Keying shall be compatible with the existing McGuire master keying system. Locks should have interchangeable cores. Designers must consult with Base Civil Engineer prior to writing the specifications.
3. Provide hardware appropriate for the Facility Group while considering activity and frequency of use and local climate; hardware may be of higher visual quality for Facility Group 1.
4. Ensure hardware will perform throughout the facility's lifespan without showing extreme wear.
5. Select finishes that will not degrade by intensity of operation or exposure to the elements.
6. Use consistent finishes and color on window and door systems throughout a facility. For renovation projects the color of new hardware may match the existing hardware.
7. Design building systems to eliminate the need for security screens whenever possible.

D06.5. Doors and Windows Materials

Note: Apply the below base-wide standards for Doors and Windows (products, materials and color). Then refer to the Appendix and apply any additional requirements specifically related to the Facility District in which the project is located.

D06.5.1. Anodized Aluminum

Applicable N/A Number of base standards 1



Type: **Anodized Aluminum Doors, Windows and Frames**

Applies to: Group 1 Group 2 Group 3 Group 4 Other

Mfr: Kawneer (or equivalent)

Color: Medium bronze

Finish: Anodized

Model #: 2x4

Other: Provide thermally broken frames

UFGS: Section 08 41 13 Aluminum-Framed Entrances and Storefronts:
<http://www.wbdg.org/FFC/DOD/UFGS/UFGS 08 41 13.pdf>

D06.5.2. Hollow Metal

Applicable N/A Number of base standards 1



Type: **Steel Doors, Windows and Frames**

Applies to: Group 1 Group 2 Group 3 Group 4 Other

Mfr: Steelcraft

Color: Medium bronze

Finish: Powder coated, satin

Model #: 2x4 frame

Other: Provide thermally broken frames

UFGS: Section 08 11 13 Steel Doors and Frames:
<http://www.wbdg.org/FFC/DOD/UFGS/UFGS 08 11 13.pdf>

D06.5.3. Aluminum-clad Wood

Applicable N/A Number of base standards 1



Type: **Aluminum-clad Residential**

Applies to: Group 1 Group 2 Group 3 Group 4 Other

Mfr: Marvin

Color: White or Earth tones

Finish: Powder coated, satin

Model #: Aluminum-clad wood windows

Other: Double hung

UFGS: Section 08 14 00 Wood Doors
<http://www.wbdg.org/FFC/DOD/UFGS/UFGS 08 14 00.pdf>

D06.5.4. Other

Applicable N/A

D07. ROOF SYSTEMS

Comply with AF Corporate Standards for Facilities Exteriors:

<http://afcfs.wbdg.org/facilities-exteriors/index.html>

Comply with AF Corporate Standards for Roof Systems:

<http://afcfs.wbdg.org/facilities-exteriors/roof-systems/index.html>

Comply with AFCFS Recommended Materials:

<http://afcfs.wbdg.org/facilities-exteriors/roof-systems/materials/index.html>

Group 1



Group 2



Group 3

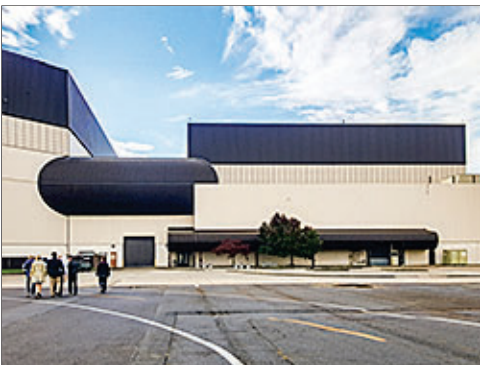

Group 4



D07.1. Roof Type and Form

1. Use proven, cost-effective roof systems with high durability, weather resistance, and low maintenance that are compatible with Installation Facilities Standards (IFS) and requirements for the designated Facility Group.
2. Generally match the roof type and form of existing adjacent facilities in new construction. Gable or hip roofs are preferred. Design one primary roof form throughout a building. Secondary roof forms may be used if needed to provide a human scale.
3. Group 1 and 2 buildings shall use hipped roofs with pitches between 3:12 and 5:12 as the primary building form for all facility types. Open gabled elements or shallow curves may be used to accent entries.
4. Use overhangs proportional to the size and height of the building.
5. Low-sloped roofs are only allowed for larger structures in combination with hipped roofs, or to match existing conditions on renovation or alteration projects.
6. Protect entrances from falling snow and ice. Use snow guards at entrances and when sidewalks are next to a building.
7. Provide screens for roof-mounted appendages and equipment of the same materials, which are used predominantly in the building's roof systems.
8. Group 2 and 3 facilities under 5,000 sf and narrow in plan geometry, may use low-sloped shed, gabled or hipped standing seam metal roofs. Larger facilities may use sloped-roof features in conjunction with predominantly minimal-sloped "flat" membrane roofs.
9. Group 4 facilities shall have gabled or hipped composite shingle roofs.
10. Match the existing roof materials for addition / alteration projects unless a significant change to the exterior envelope is included.
11. Roof eaves shall extend beyond the exterior wall for roof drainage and shading.
12. The color, shape and slope of the eave and soffit shall be compatible with adjacent facilities.
13. Keep roofs uncluttered and minimize penetrations.
14. Diminish massive roofs into coordinated smaller components consistent with adjacent facilities; avoid random, arbitrary changes.
15. Increase the insulation value of existing roofing systems during renovations if supported by life cycle cost and structural analysis.
16. Roofs shall be maintained for the life of the system and replaced in accordance with UFC 3-110-04 and AFI 32-1051. A warranty is required on all new roofs.
17. Provide roof warranties for new and repair projects as follows:
 - Metal roof: Fluoropolymer (e.g. Kynar 500) factory finish, 25 years on materials. Warranty includes water tightness and finish. Two year (2) warranty on installation to include weather tightness, water tightness and against all leaks.
 - Asphalt Shingles: 30 years on materials. Two year (2) warranty on installation to include weather tightness, water tightness and against all leaks.
 - EPDM, Modified bitumen, Built-up roof: 20 years on materials. Two year (2) warranty on installation to include weather tightness, water tightness and against all leaks.
18. Membrane roofing for low-sloped roofs may only be used with pre approval. A warranted minimum slope is ½:12 is required.
19. On renovations and repair projects generally match the original roofing material, color, shape, size, texture, appearance, and thermal expansion properties.
20. Manufacturers listed below are only provided to establish a baseline of equivalency among all applicable manufacturers.

D07.2. Roof Slope

1. Group 1 and 2 buildings shall use sloped roofs, min. 3:12.
2. Low-sloped roofs are allowed for larger structures, or to match existing conditions on renovation/alteration projects. Hangars may have slopes as low as 1:12 with the approval of the Base Civil Engineer.
3. Group 4 facilities shall use 4:12 to 6:12 roof slopes.
4. Ensure adequate drainage, and connect to the subsurface rain collection system where available.
5. Provide roof slopes to accommodate solar renewable and passive systems and daylighting when applicable following UFC 1-200-02.
6. Provide underlayments as required for the roofing type as directed by the UFC.

D07.3. Parapets and Copings

1. Extend wall materials vertically above the roof line and provide metal copings to match the wall. Ensure copings are properly flashed and detailed to avoid roof leaks.

D07.4. Color and Reflectivity

1. Sloped roofs in Groups 1 and 2 and smaller facilities in Group 3 shall be dark brown fed std#20040 or similar color as approved by the COR to match adjacent facilities and follow requirements of IFS.
2. All minimal-slope membrane roofs shall use only use high-albedo, high reflectivity color to help decrease the temperature around the buildings and minimize damage to human and wildlife habitat.
3. Sloped roofs in Group 4 shall be Earth tones.
4. Comply with UFC 3-110-03 and ASHRAE 90.1 for Solar Reflectance Index (SRI) and thermal requirements.
5. All roof flashing shall match the color of the predominant background material.

D07.5. Gutters, Downspouts, Scuppers, Drains

1. All sloped roofs shall use gutters and downspouts. Gutters shall be outside the fascia. Concealed gutters may be used when located outside the exterior wall finish system. Ensure rain diverters or gutters and downspouts are provided over building entrances.
2. Internal roof drainage systems are not permitted in new construction. Minimal-sloped roofs shall be sloped to drain to the building perimeter through scuppers into downspouts.
3. All gutters and fascias shall match the roof color.
4. Size the roof drainage system per IBC and SMACNA for the region.
5. Use scuppers as required in parapet walls. Arrange scuppers in an orderly manner consistent with other elements of the wall system.
6. When open scuppers are connected to downspouts, provide transitions consistent with adjacent facilities.
7. Integrate downspouts with the architectural details of the wall system.
8. Fabricate downspouts from non-corrosive materials such as aluminum or zinc-coated steel. Provide powder-coated finishes in medium bronze to match roof color or match building color, check with COR.
9. Construct all downspouts with the least amount of connections.
10. Provide angled transitional pieces for downspouts to fit closely against the wall for their entire length.

11. Coordinate locations of downspouts to conceal control joints in masonry walls when possible.
12. Place downspouts away from building entries. Water discharged should not run across sidewalks.

D07.6. Roof Vents and Elements

1. Minimize and consolidate roof penetrations into a single, inconspicuous point whenever possible. Roof penetrations should be made on the least visible sides of the roof (back or side elevations).
2. Penetrations should be kept to a minimum.
3. On sloped roofs clad pipe penetrations to match the roofing material.
4. Avoid the use of rooftop mechanical equipment, however for renovations and unavoidable configurations ensure units are screened. Use of rooftop equipment requires Base Civil Engineer (BCE) approval.
5. Provide access points and service routes to equipment that protect the roof.
6. Screen all large vents.
7. Ensure attic spaces are properly vented at ridges and soffits.
8. Match roof color for all exposed equipment and vents.
9. Avoid roof-mounted antenna systems.
10. Arrange Lightning Protection Systems (LPS) components in an ordered, uncluttered, inconspicuous appearance and integrated into the organization of the roof and wall systems.
11. Ensure that LPS roof mounting systems are approved by the roofing manufacturer.
12. Additions to a roof shall not interfere with LPS or other rooftop systems that may be required.
13. Permanent fall protection shall be included with any addition to a roof with a slope above 3:12 per UFC 3-110-03 to a roof with a slope above 3:12 per UFC 3-110-03.

D07.7. Clerestories and Skylights

1. Clerestories and skylights are permitted in Group 1 facilities. These are allowed in Group 3 facilities only when serving passive systems and are justifiable by life-cycle analysis.
2. Clerestories are preferred to skylights to avoid roof penetrations. Skylights, when permitted, must be simple in shape and integrated with the roof system to eliminate leakage.
3. Design clerestories and skylights using the same principles for seasonal shading that are required for walls and roof overhangs.
4. Translucent panel systems are preferred in clerestory applications due to lack of window cleaning in Group 3 facilities.
5. Clerestories and skylights must comply with UFC 4-10-01.

D07.8. Vegetated Roof

1. Not applicable.

D07.9. Roof Systems Materials

Note: Apply the below base-wide standards for Roof Systems (products, materials and color). Then refer to the Appendix and apply any additional requirements specifically related to the Facility District in which the project is located.

D07.9.1. Standing Seam Metal

Applicable N/A Number of base standards 1



Type: **Style 1**

Applies to: Group 1 Group 2 Group 3 Group 4 Other

Mfr: Valspar

Color: Brown - fed. Std. #20040

Finish: Factory matte (Standing seam metal)

Model #: Tee-Panel

Other: Shed, gabled or hipped standing seam metal

UFGS: Section 07 61 14 Steel Standing Seam Roofing
<http://www.wbdg.org/FFC/DOD/UFGS/UFGS 07 61 14.00 20.pdf>

D07.9.2. Membrane Single-ply

Applicable N/A Number of base standards 1



Type: **Style 1**

Applies to: Group 1 Group 2 Group 3 Group 4 Other

Mfr: Carlisle Systems

Color: Off-white

Finish: Smooth

Model #: TPO single-ply, "flat" minimal slope

Other: N/A

UFGS: Section 07 53 23 Ethylene-Propylene-Diene-Monomer Roofing
<http://www.wbdg.org/FFC/DOD/UFGS/UFGS 07 53 23.pdf>
Section 07 54 50 TPO Thermoplastic Single-Ply Roofing
(Not Available on UFGS)

D07.9.3. Built-up Multi-ply

Applicable N/A

D07.9.4. Concrete Tile

Applicable N/A

D07.9.5. Clay Tile

Applicable N/A

D07.9.6. Slate Shingles

Applicable N/A

D07.9.7. Vegetated System

Applicable N/A

D07.9.8. Ribbed Metal Sheeting

Applicable N/A Number of base standards 1

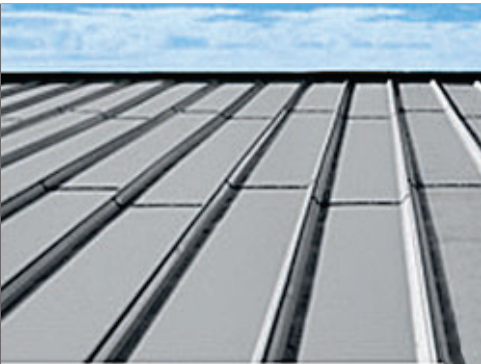

Type: **Style 1**

Applies to: Group 1 Group 2 Group 3 Group 4 Other

Mfr: Berridge

Color: Galvalume

Finish: Factory

Model #: High Seam Tee-Panel

Other: 24 gauge steel, Width: 16" Batten height: 1-3/4"

UFGS: Section 07 41 13.19 Batten-Seam Metal Roof Panels
(Not Available on UFGS)

D07.9.9. Composite Shingles

Applicable N/A Number of base standards 1



Type: **Style 1**

Applies to: Group 1 Group 2 Group 3 Group 4 Other

Mfr: GAF Timberline

Color: Earth Tones

Finish: Factory

Model #: Asphalt T-lock

Other: Gabled or hipped with transverse gable or hipped features

UFGS: Section 07 31 13 Glass-fiber-reinforced Asphalt Shingles
<http://www.wbdg.org/FFC/DOD/UFGS/UFGS 07 31 13.pdf>

D07.9.10. Other

Applicable N/A

D08. STRUCTURAL SYSTEMS

Comply with AF Corporate Standards for Facilities Exteriors:

<http://afcs.wbdg.org/facilities-exteriors/index.html>

Comply with AF Corporate Standards for Structural Systems:

<http://afcs.wbdg.org/facilities-exteriors/structural-systems/index.html>

Comply with AFCFS Recommended Materials:

<http://afcs.wbdg.org/facilities-exteriors/structural-systems/materials/index.html>

Group 1



Group 2



Group 3



Group 4



D08.1. Systems and Layouts

1. Pre-engineered structural steel framing may be used for Groups 1, 2 and 3 facilities; Installation-appropriate thermal envelopes, materials and detailing are required.
2. Select economical structural systems that integrate roof and wall systems.
3. Narrow buildings 60' or less in width with column-free interiors are preferred for office, administrative and personnel spaces; when interior columns are required optimize the structural grid layout for open-plan arrangements.
4. Fully coordinate structural grids with exterior window systems to align columns with window frames or wall systems.
5. When structure is exposed provide an organized appearance and coordinate with mechanical, electrical, plumbing, fire protection, information technology, and communications systems.
6. Limit the use of specialty systems (such as space frames, vaults or domes) and of structure as a visual feature.
7. Cost-effectively design interior bearing walls as thermal mass.
8. Manufacturers listed below are only provided to establish a baseline of equivalency among all applicable manufacturers.

D08.2. Structural Systems Materials

Note: Apply the below base-wide standards for Structural Systems (products, materials and color). Then refer to the Appendix and apply any additional requirements specifically related to the Facility District in which the project is located.

D08.2.1. Concrete

Applicable N/A

D08.2.2. Insulated Concrete Forming (ICF)

Applicable N/A

D08.2.3. Steel

Applicable N/A Number of base standards 1



Type: **Rigid Framing**

Applies to: Group 1 Group 2 Group 3 Group 4 Other

Mfr: US Steel

Color: Shop primed

Finish: Matte

Model #: Structural steel shapes

Other: N/A

UFGS: Section 05 12 00 Structural Steel
<http://www.wbdg.org/FFC/DOD/UFGS/UFGS 05 12 00.pdf>

D08.2.4. Pre-Engineered Steel

Applicable N/A Number of base standards 1



Type: **Moment Frame**

Applies to: Group 1 Group 2 Group 3 Group 4 Other

Mfr: Behlen Building Systems

Color: Factory primed

Finish: Matte

Model #: Moment Frame

Other: Draped insulation may be used behind wall system;
Behlen standing seam roof system may be used for Group 3

UFGS: Section 13 12 00 Steel Building Systems
(Not Available on UFGS)
Section 13 34 19 Metal Building Systems
<http://www.wbdg.org/FFC/DOD/UFGS/UFGS 13 34 19.pdf>

D08.2.5. Masonry

Applicable N/A

D08.2.6. Heavy Timber

Applicable N/A

D08.2.7. Light-gauge Steel

Applicable N/A Number of base standards 1



Type: **Steel Framing**

Applies to: Group 1 Group 2 Group 3 Group 4 Other

Mfr: Steelrite

Color: Factory

Finish: Galvanized

Model #: Structural framing shapes

Other: N/A

UFGS: Section 05 45 00 Light Gauge Steel Framing System
(Not Available on UFGS)

D08.2.8. Lumber Framing

Applicable N/A

D08.2.9. Other

Applicable N/A

D09. MECHANICAL, ELECTRICAL AND PLUMBING

Comply with AF Corporate Standards for Facilities Exteriors:

<http://afcs.wbdg.org/facilities-exteriors/index.html>

Comply with AF Corporate Standards for Mechanical, Electrical and Plumbing:

<http://afcs.wbdg.org/facilities-exteriors/machanical-electrical-and-plumbing/index.html>

Group 1



Group 2



Group 3



Group 4



D09.1. Passive and Active Systems

1. Fully integrate passive heating and cooling systems into facility designs whenever practical for the local climate prior to the design of active mechanical systems.
2. Provide optimized passive and active systems; design active mechanical systems to supplement thermal mass walls and floors.
3. Develop renewable energy systems when life cycle cost effective.
4. Integrate shading into building exteriors to reduce solar heat gain during hot seasons.

D09.2. Functionality and Efficiency

1. Fully coordinate mechanical, electrical, plumbing (MEP) and fire protection systems with each other and with the building structure, enclosure, thermal envelope and interior design.
2. Ensure direct exterior access is provided (for CE) to main mechanical and electrical rooms.
3. Screen exterior equipment from primary views (landscape, building masses, screen walls) and comply with ATFP requirements.
4. Keep equipment away from main building entrances; locate service area/yard on least visible side of a building. Provide tie-ins for portable system in case of HVAC system break-downs.
5. Coordinate the location of all exterior meters, equipment and devices to provide convenient access and an overall coordinated and orderly appearance.
6. Design emergency generator systems integrally with all other building systems and avoid incompatible building additions; locate generators near service areas and ensure they are not visible from primary entrances.
7. When structure is exposed as a finished ceiling, fully integrate MEP and fire protection systems to provide an organized uncluttered appearance.
8. Conceal ducts, piping, conduits, devices, etc., when permanent walls, suspended ceilings or raised floors are provided.
9. Limit interior wall-mounted equipment in occupied personnel spaces; avoid surface-mounted conduit and pipes. If feasible, always locate fan coil units on floor. Pipe risers shall be accessible and have a shutoff valve on each floor. Roof drains shall not be connected to sanitary systems.
10. Provide efficient utility rooms with layouts to facilitate system performance and maintenance; provide convenient access to controls, clearly label systems and include operating and maintenance instructions.
11. Separate mechanical and electrical and communications rooms. Communication rooms shall have always have their own air conditioning system.
12. Integrate recessed and wall-mounted fixtures such as fire standpipe cabinets and drinking fountains within permanent walls.
13. All buildings shall have the appropriate backflow preventer.

E. FACILITIES INTERIORS

Comply with Air Force Corporate Standards for Facilities Interiors:
<http://afcs.wbdg.org/facilities-interiors/index.html>

Group 1

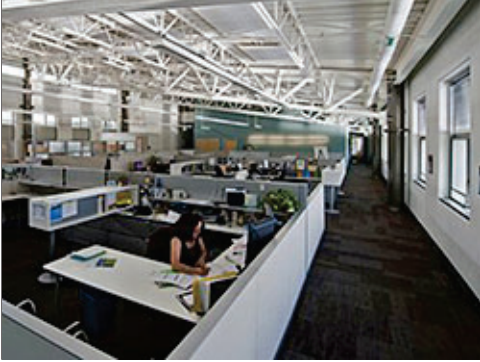

Group 2



Group 3

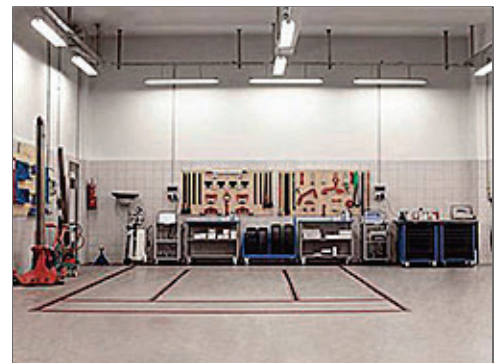
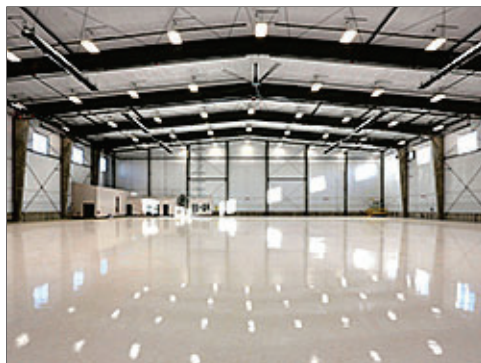

Group 4



E01. Building Configurations

Comply with Air Force Corporate Standards for Building Configurations:

<http://afcfs.wbdg.org/facilities-interiors/buildings-configurations/index.html>

1. Provide open-plan configurations for office, administrative, operational and related activities and spaces for maximum flexibility. Use a “core and shell” approach in which all building systems, infrastructure and permanent interior partitions anticipate two or more uses (operations) during a facility’s lifespan.
2. Create flexible interior configurations using Furniture, Fixtures & Equipment (FF&E) and limit private offices and private rooms. Refer to AFMAN 32-1084 for space requirements. To the greatest extent, limit permanent partitions to core areas such as toilet rooms, stairs, mechanical and utility rooms.
3. Use more durable long-lasting finishes in core areas for walls, ceilings, floor coverings and built-in casework. Coordinate interior FF&E layouts with structural grids during space planning.
4. Provide high-performance building configurations following UFC 1-200-02. Ensure passive design strategies are cost effectively incorporated before active mechanical systems are designed.
5. Comply with UFC 1-200-01, general building requirements. UFC 1-200-01 provides applicability of model building codes and government unique criteria for typical design disciplines and building systems, as well as for accessibility, antiterrorism, security, high performance and sustainability requirements, and safety.
6. Meet security and force protection requirements in UFC 4-010-01: DoD Minimum Antiterrorism Standards for Buildings.
7. Comply with AFCFS for supporting mission requirements, addressing human comfort and well being, and creating highly flexible interiors while satisfying metrics for high performance and sustainable buildings.
8. Provide a level of quality for interior features, materials and finishes that is appropriate for the Facility Group number. Group 1 may receive higher quality than Groups 2 thru 4. Refer to Facility Hierarchy.
9. Through open-plan configurations, preserve all passive and natural design strategies and fully integrate facility interiors with overall building systems.
10. Professional interior designers, or architects with significant interior design experience, should accomplish the design and review of major new construction, renovations and projects.
11. Consult with the State Historic Preservation Officer (SHPO) and base-level Historic Preservation offices regarding proposed changes to properties listed on or eligible for listing on the National Register of Historic Places. Follow requirements of The National Historic Preservation Act and Secretary of the Interior Standards for the Treatment of Historic Properties.
12. Maintain architectural compatibility following AFCFS and this Installation Facilities Standards (IFS) document to create continuity while avoiding monotony.

E01.1. Layout and Common Areas

Comply with Air Force Corporate Standards for Layout and Common Areas:

<http://afcfs.wbdg.org/facilities-interiors/buildings-configurations/layout-and-common-areas/index.html>

1. Create open-plan interior environments to accommodate changes.
2. Limit interior partitions, private offices and rooms; use furniture or modular systems to provide privacy and acoustic control.
3. When partitions are functionally justified such as for conference rooms, use systems furniture and moveable (demountable) floor-to-ceiling wall systems for acoustical or visual privacy.
4. Proportion lobbies and common spaces based on type of function, activity and facility group.
5. Allow no direct sight lines into restrooms.
6. Situate utility and core areas to minimize impact on daylighting and to maximize use as thermal buffers.

7. Ensure electrical, lighting and communications system can be adaptable to configuration changes.
8. Avoid power poles to the maximum extent; when poles are necessary minimize the number and coordinate locations with furniture placement and other elements.
9. Avoid sloping floors to maintain flexibility and eliminate future structural changes.
10. Special consideration may apply to Sensitive Compartmented Information Facilities (SCIFs).

E01.1.1. Interior Design Process

1. Comply with UFC 3-120-10 for the Comprehensive Interior Design (CID,) which includes both Structural Interior Design (SID) and Furniture, Fixtures & Equipment (FF&E) design services.
2. Use a collaborative, integrated planning and design team, composed of user, government support staff, and appropriate professionals. Integrate architectural features using simple detailing to create a professional appearance; avoid extravagant or excessive detailing.
3. Ensure interior designs satisfy the functional requirements within the context of flexibility, sustainability and the building's energy performance.
4. Base space planning on square foot allocations from AFM 32-1084. Identify special requirements if any, such as privacy separation, VIP areas, gathering spaces and storage. Note: The occupant's rank and position will influence the square footage and selection of materials.
5. Provide clear circulation and pathway finding for both horizontal and vertical directions that accommodate the number of personnel in the facility.
6. Maximize efficiencies in the space plan for functional relationships and adjacencies for all facility users. Efficiently create and situate rooms and support rooms such as conference / meeting rooms and break rooms.
7. Provide interior design building-related illustrations, drawings, schedules, materials selections, specifications and cost estimates as listed in UFC 3-120-10. Refer to Furnishings in this IFS also.
8. SID Format shall follow HQ AFCEC standards.
9. Base the FF&E package on the furniture footprint developed in the SID. Identify all new or existing equipment needed and its users within each facility or each area of the facility. Provide specific information on: equipment sizes, electrical requirements, ventilation requirements, weight (if heavy), quantity, and security level if required. Presume all administrative spaces have computers and supporting equipment.

E01.1.2. Codes and Regulations

1. Refer to UFC 1-200-01 for modifications to the International Building Code (IBC) to determine applicable sections of the IBC. Both the IBC Chapter 3 and UFC 3-600-01 govern "Use and Occupancy Classification" for example.
2. Fire code requirements shall be as defined in the International Building Code (IBC) and must be used where dictated by UFC 1-200-01 DoD Building Code (General Building Requirements) except where noted in UFC 3-600-01 (Fire Protection Engineering For Facilities).
3. National Fire Protection Association (NFPA) 101 must be utilized to determine the occupancy classification as it relates to fire/ smoke resistance rating of interior non-load bearing partitions (other than occupancy separation), means of egress, interior finish, features of fire protection (including vertical openings) and associated requirements.

E01.2. Quality and Comfort

Comply with Air Force Corporate Standards for Quality and Comfort:

<http://afcs.wbdg.org/facilities-interiors/buildings-configurations/quality-and-comfort/index.html>

1. Include durability in the life cycle cost analysis for best-value material selections with long life expectancies that do not show excessive wearing.

2. Select long-lasting materials and finishes for permanent core areas such as lobbies, restrooms and stairs.
3. Select low-maintenance materials and products that reduce ongoing servicing and repair and that are easy to clean.
4. Relate the visual quality of finishes to the Facility Group number.
5. Building and interior configurations should address both operations and climatic responses.
6. Convey a professional image; avoid trendy patterns and textures.
7. Use materials and finishes that provide a healthy indoor environment.
8. Orient interior spaces toward views while maintaining cost-effective building performance and efficiency.
9. Promote air movement and daylighting for human health and wellbeing.

E02. Floors

Comply with Air Force Corporate Standards for Floors:
<http://afcfs.wbdg.org/facilities-interiors/floors/index.html>

E02.1. Floor Materials

Facility Group 1 floor materials shall be as follows.

- Primary: Prepared Slabs (Ground, Polished)
- Secondary: Porcelain tile
- Tertiary: Carpet, Rubber Stair Treads

Facility Group 2 floor materials shall be as follows.

- Primary: Prepared Slabs (Ground, Polished)
- Secondary: Ceramic tile
- Tertiary: Carpet, Rubber Stair Treads

Facility Group 3 floor materials shall be as follows.

- Primary: Prepared Slabs (Ground)
- Secondary: Prepared Slabs (Sealer)
- Tertiary: N/A

Facility Group 4 floor materials shall be as follows.

- Primary: Carpet
- Secondary: Ceramic tile
- Tertiary: N/A

1. Natural stone and terrazzo flooring may be used in high traffic areas of Group 1 as approved on a case basis.
2. Resilient and rapidly renewable flooring may be used in low traffic areas in Group 1, 2 and 4.
3. Manufacturers listed below are only provided to establish a baseline of equivalency among all applicable manufacturers.

Note: Apply the below base-wide standards for Floors (products, materials and color). Then refer to the Appendix and apply any additional requirements specifically related to the Facility District in which the project is located.

E02.1.1. Prepared Slabs

Applicable N/A Number of base standards 3



Type: **Style 1, Ground and Polished**

Applies to: Group 1 Group 2 Group 3 Group 4 Other

Mfr: Local

Color: Natural gray cement, light to dark beige aggregates

Finish: Fine polished texture

Model #: Medium to small aggregate

Other: In Group 3 this style is only permitted in administrative areas.

UFGS: Section 03 35 45 Polished Concrete Finishing
(Not Available on UFGS)

Type: **Style 2, Medium Polished**

Applies to: Group 1 Group 2 Group 3 Group 4 Other

Mfr: Local

Color: Natural gray cement, light to dark beige aggregates

Finish: Medium polished texture, slip resistant

Model #: Medium to small aggregate

Other: N/A

UFGS: Section 03 35 45 Polished Concrete Finishing
(Not Available on UFGS)





Type: **Style 3, High-Performance Coatings on Slabs**

Applies to: Group 1 Group 2 Group 3 Group 4 Other

Mfr: Sherwin-Williams

Color: See Standard GP color

Finish: High Gloss with the final seal coat

Model #:

Other: GP 3579 & 4638 are components of the GP "Aircraft Hangar/Industrial Plant Coating" system. Apply mock up / test application to confirm color and sheen. UFGS Section 09 96 00 High-Performance Coatings

UFGS: Section 03 35 45 Polished Concrete Finishing
(Not Available on UFGS)

E02.1.2. Natural Stone and Terrazzo

Applicable N/A

E02.1.3. Quarry Tile

Applicable N/A Number of base standards 1

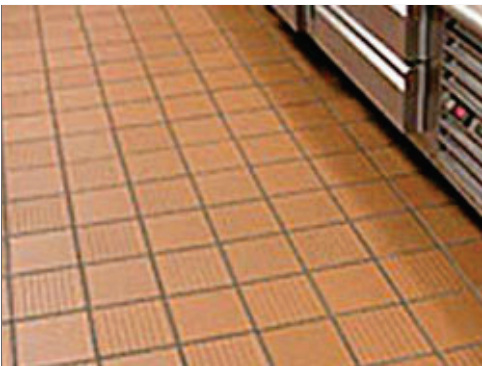

Type: **Style 1**

Applies to: Group 1 Group 2 Group 3 Group 4 Other

Mfr: Daltile

Color: Earth tones

Finish: Matte, slip resistant

Model #: N/A

Other: Use in commercial kitchen flooring.

UFGS: Section 09 30 10 Ceramic, Quarry, and Glass Tiling
http://www.wbdg.org/FFC/DOD/UFGS/UFGS_09_30_10.pdf

E02.1.4. Ceramic Tile

Applicable N/A

Number of base standards 2



Type: **Style 1 Porcelain**

Applies to: Group 1 Group 2 Group 3 Group 4 Other

Mfr: Daltile

Color: Neutrals

Finish: Slip resistant

Model #: Porcelain tile

Other: Use in high traffic areas. Epoxy grout is recommended.

UFGS: Section 09 30 10 Ceramic, Quarry, and Glass Tiling
<http://www.wbdg.org/FFC/DOD/UFGS/UFGS 09 30 10.pdf>

Type: **Style 2 Ceramic**

Applies to: Group 1 Group 2 Group 3 Group 4 Other

Mfr: Daltile

Color: Neutrals

Finish: Matte, slip resistant

Model #: Ceramic tile

Other: Use in low traffic area toilet rooms.

UFGS: Section 09 30 10 Ceramic, Quarry, and Glass Tiling
<http://www.wbdg.org/FFC/DOD/UFGS/UFGS 09 30 10.pdf>



E02.1.5. Resilient Floor

Applicable N/A Number of base standards 2



Type: **Style 1 VCT / Vinyl Sheeting**

Applies to: Group 1 Group 2 Group 3 Group 4 Other

Mfr: Armstrong

Color: Neutral tones

Finish: Factory

Model #: Vinyl Composition Tiles/Sheets

Other: N/A

UGFS: Section 09 65 00 Resilient Flooring

<http://www.wbdg.org/FFC/DOD/UGFS/UGFS 09 65 00.pdf>

Type: **Style 2 Stair Treads**

Applies to: Group 1 Group 2 Group 3 Group 4 Other

Mfr: Roppe

Color: Neutral tones

Finish: Factory

Model #: Raised design rubber treads

Other: In Group 3 use in non-industrial office areas only.

UGFS: Section 09 65 00 Resilient Flooring

<http://www.wbdg.org/FFC/DOD/UGFS/UGFS 09 65 00.pdf>



E02.1.6. Carpet

Applicable N/A

Number of base standards 4



Type: **Style 1 (Moderate Traffic) (Broadloom)**

Applies to: Group 1 Group 2 Group 3 Group 4 Other

Mfr: Shaw Contract Group

Color: Neutral multi-colored tones/patterned/solid

Finish: 1) Eco Solution Q; 2) Entry walk-off Carpet: "Path Tile" #5T034

Model #: Broadloom, "Movement #5A025"

Other: 1)90% SD / 10% Yarn Dyed, Backing – Ultraloc, Ounce weigh – 28, Stitches - 1/10, Gauge - 12.0, Ave. Density - 6000; 2) 100% SD, Backing – Ecoworx, Wt. 28, Stitches - 1/12, Gauge - 9.0, Ave. Density 8700

UFGS: UFGS 09 68 00 Carpeting

<http://www.wbdg.org/FFC/DOD/UFGS/UFGS 09 68 00.pdf>

Type: **Style 2 (Moderate Traffic) (Carpet Tile)**

Applies to: Group 1 Group 2 Group 3 Group 4 Other

Mfr: Shaw Contract Group

Color: Neutral, Multi-colored/patterned/solid

Finish: 1) Eco Solution Q; 2) Entry walk-off Carpet: "Path Tile" #5T034

Model #: Broadloom, residential loop, "Smartstrand"

Other: 1)100% SD / 10% Yarn Dyed, Backing – Ultraloc, Ounce Wt. – 20, Stitches - 1/10, Gauge - 10.0, Ave. Density - 7200; 2) 100% SD, Backing – Ecoworx, Wt. 28, Stitches - 1/12, Gauge - 9.0, Ave. Density 8700

UFGS: UFGS 09 68 00 Carpeting

<http://www.wbdg.org/FFC/DOD/UFGS/UFGS 09 68 00.pdf>

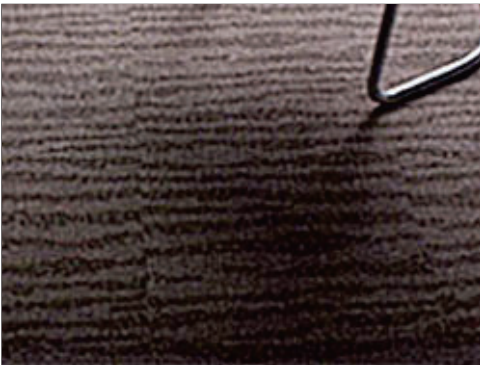



Type: **Style 3 (High Traffic) (Broadloom)**

Applies to: Group 1 Group 2 Group 3 Group 4 Other

Mfr: Shaw Contract Group

Color: Neutral, Multi-colored/patterned/solid

Finish: 1) Solution Q Extreme; Entry walk-off: "Entrée Tile", PET Polyester

Model #: Broadloom, "Dusk #60765"

Other: 1) 100% SD, Backing – Ultraloc, Wt. 24, Stitches - 1/12, Gauge - 12.0, Average Density – 7300; 2) 100% SD, Backing – Ecoworx tile, Ounce weigh – 44, Stitches - 1/12, Gauge - 11.0, Average Density 7700

UFGS: UFGS 09 68 00 Carpeting
<http://www.wbdg.org/FFC/DOD/UFGS/UFGS 09 68 00.pdf>

Type: **Style 4 (High Traffic) (Carpet Tile)**

Applies to: Group 1 Group 2 Group 3 Group 4 Other

Mfr: Shaw Contract Group

Color: Neutral, Multi-colored/patterned/solid

Finish: 1) Solution Q Extreme, 2) Entry walk-off: "Entrée Tile", PET Polyester

Model #: Carpet Tile, "Unwind #5T090"

Other: 1) Dye Method - 100% Solution Dyed, Backing – Ecoworx Tile, Wt. 22, Stitches - 1/12, Gauge - 11.0, Ave. Density – 7400; 2) 100% SD, Backing – Ecoworx tile, Wt. 44, Stitches - 1/12, Gauge - 11.0, Ave. Density 7700

UFGS: UFGS 09 68 00 Carpeting
<http://www.wbdg.org/FFC/DOD/UFGS/UFGS 09 68 00.pdf>



E02.1.7. Rapidly-Renewable Products

Applicable N/A Number of base standards 1



Type: **Style 1**

Applies to: Group 1 Group 2 Group 3 Group 4 Other

Mfr: Armstrong

Color: Neutrals, accent colors

Finish: Slip-resistant

Model #: Linoleum, sheet or tile

Other: Add high-performance coating.
UFGS: Section 09 65 00 Resilient Flooring

UFGS: Section 09 62 23 Strand Woven Bamboo Flooring
(Not Available on UFGS)

E02.1.8. Other

Applicable N/A

E03. Walls

Comply with Air Force Corporate Standards for Walls:
<http://afcfcs.wbdg.org/facilities-interiors/walls/index.html>

E03.1. Wall Materials

Facility Group 1 wall materials shall be as follows.

Primary: Gypsum board (painted)

Secondary: Ceramic tile (restrooms)

Tertiary: N/A

Facility Group 2 wall materials shall be as follows.

Primary: Gypsum board (painted)

Secondary: Ceramic tile (restrooms)

Tertiary: N/A

Facility Group 3 wall materials shall be as follows.

Primary: Ground face / split face block / metal panels

Secondary: Gypsum board (painted) (Office Areas)

Tertiary: Ceramic tile (restrooms)

Facility Group 4 wall materials shall be as follows.

Primary: Gypsum board (painted)

Secondary: N/A

Tertiary: Ceramic tile (restrooms)

1. Follow UFC 3-450-01 (Vibration and Noise Control) for acoustic design issues including speech privacy, sound isolation or sound masking.
2. Select and apply paint with sheens (gloss levels) appropriate for the application following UFGS Section 09 90 00 Paints and Coatings.
3. Provide ceramic tile on wet walls of kitchens, toilet rooms, locker rooms, etc., in all facility groups.
4. Neutral split-face or ground-face integrally colored block with a clear sealer may be used in Group 3. Do not paint block.
5. Provide rubber base on drywall partitions in Groups 1 and 2.
6. Hardwood base may only be used in Group 1 as approved on a case basis.
7. Hardwood chair rails / bumper rails may be used in high-use areas of Groups 1 and 2; aqueous clear finishes are preferred to reduce maintenance; plastic chair rails are permitted only in medical applications.
8. Decorative moldings may be used only in Group 1 when approved on a case basis.
9. Corner guards are permitted only in high traffic spaces with wheeled or cart use such as private service areas in Groups 1 and 2; stainless steel corners guards with a brushed finish may be judiciously used in Group 3.
10. Group 4 may use painted composite wood base.
11. Manufacturers listed below are only provided to establish a baseline of equivalency among all applicable manufacturers.

Note: Apply the below base-wide standards for Walls (products, materials and color). Then refer to the Appendix and apply any additional requirements specifically related to the Facility District in which the project is located.

E03.1.1. Concrete

Applicable N/A

E03.1.2. Masonry

Applicable N/A

Number of base standards 1



Type: **CMU**

Applies to: Group 1 Group 2 Group 3 Group 4 Other

Mfr: Texas Building Products

Color: Neutral

Finish: Split face block / ground face block

Model #: Coursed unit masonry, 8x8x16 nominal face and corner units

Other: Concrete block may only be used in Group 3 when approved by the BCE.

UFGS: Section 03 33 00 Cast-In-Place Architectural Concrete
<http://www.wbdg.org/FFC/DOD/UFGS/UFGS 03 33 00.pdf>

E03.1.3. Ceramic Tile

Applicable N/A

Number of base standards 1



Type: **Style 1**

Applies to: Group 1 Group 2 Group 3 Group 4 Other

Mfr: Daltile

Color: Neutrals/Accents may be used

Finish: Matte/Glossy

Model #: Ceramic wall tile

Other: Located on wet walls in restrooms

UFGS: Section 09 30 10 Ceramic, Quarry, and Glass Tiling
<http://www.wbdg.org/FFC/DOD/UFGS/UFGS 09 30 10.pdf>

E03.1.4. Gypsum Board

Applicable N/A Number of base standards 1



Type: **Style 1**

Applies to: Group 1 Group 2 Group 3 Group 4 Other

Mfr: US Gypsum

Color: Solid Earth tone colors

Finish: Paint (Sheen per UFGS)

Model #: Tapered edge

Other: N/A

UFGS: Section 09 29 00 Gypsum Board
[http://www.wbdg.org/FFC/DOD/UFGS/UFGS 09 29 00.pdf](http://www.wbdg.org/FFC/DOD/UFGS/UFGS%2009%2029%2000.pdf)
Section 09 90 00 Paints and Coatings
[http://www.wbdg.org/FFC/DOD/UFGS/UFGS 09 90 00.pdf](http://www.wbdg.org/FFC/DOD/UFGS/UFGS%2009%2090%2000.pdf)

E03.1.5. Metal Panels

Applicable N/A

E03.1.6. Wood Paneling

Applicable N/A

E03.1.7. Rapidly-Renewable Products

Applicable N/A

E03.1.8. Other

Applicable N/A

E04. Ceilings

Comply with Air Force Corporate Standards for Ceilings:
<http://afcf.wbdg.org/facilities-interiors/ceilings/index.html>

E04.1. Ceiling Materials

Facility Group 1 ceiling materials shall be as follows.

Primary: Exposed Framing (Roof / Floor Structure Above)
Secondary: Grid and Acoustical Tile
Tertiary: Gypsum board (painted)

Facility Group 2 ceiling materials shall be as follows.

Primary: Exposed Framing (Roof / Floor Structure Above)
Secondary: Grid and Acoustical Tile
Tertiary: Gypsum board (painted)

Facility Group 3 ceiling materials shall be as follows.

Primary: Exposed Framing (Roof / Floor Structure Above)
Secondary: Exposed Framing (Roof / Floor Structure Above)
Tertiary: Gypsum board (painted)

Facility Group 4 ceiling materials shall be as follows.

Primary: Gypsum board (painted)
Secondary: N/A
Tertiary: N/A

1. Accent ceiling materials such as metal, wood, and rapidly renewable may be used in Group 1 as approved on a case basis.
2. Follow UFC 3-450-01 (Vibration and Noise Control) for acoustic design issues including speech privacy, sound isolation or sound masking.
3. Manufacturers listed below are only provided to establish a baseline of equivalency among all applicable manufacturers.

Note: Apply the below *base-wide standards* for Ceilings (products, materials and color). Then refer to the Appendix and apply any additional requirements specifically related to the Facility District in which the project is located.

E04.1.1. Exposed Framing (Roof / Floor Structure Above)

Applicable N/A Number of base standards 1

Type: **Style 1**

Applies to: Group 1 Group 2 Group 3 Group 4 Other

Mfr: Vulcraft

Color: Neutral colors reviewed on a case basis

Finish: Field painted (Sheen per UFGS)

Model #: Formlok floor and roof decking

Other: N/A



UFGS: Section 05 30 00 Steel Decks
http://www.wbdg.org/FFC/DOD/UFGS/UFGS_05_30_00.pdf

E04.1.2. Exposed Concrete

Applicable N/A

E04.1.3. Grid and Acoustical Tile

Applicable N/A Number of base standards 2



Type: **Style 1**

Applies to: Group 1 Group 2 Group 3 Group 4 Other

Mfr: Armstrong

Color: White

Finish: Factory

Model #: 2'x2' Tegular with reveal edge and fine texture, grid 15/16"

Other: Use only in Group 2 with BCE approval. Performance characteristics are NRC .95, Class A, Light Reflectance .90; minimum recycled content 82%.

UFGS: Section 09 51 00 Acoustical Ceilings
<http://www.wbdg.org/FFC/DOD/UFGS/UFGS 09 51 00.pdf>

Type: **Style 2**

Applies to: Group 1 Group 2 Group 3 Group 4 Other

Mfr: Armstrong

Color: White

Finish: Ultima (for restrooms)

Model #: 24" x 24" x 1" tiles, NRC .80, Class A, Bio-Block, Humi-Guard+

Other: N/A

UFGS: Section 09 51 00 Acoustical Ceilings
<http://www.wbdg.org/FFC/DOD/UFGS/UFGS 09 51 00.pdf>



E04.1.4. Gypsum Board

Applicable N/A Number of base standards 1



Type: **Style 1**

Applies to: Group 1 Group 2 Group 3 Group 4 Other

Mfr: American Gypsum

Color: Factory, field painted solid neutral colors

Finish: Paint (sheen per UFGS)

Model #: Tapered edge

Other: Type X (Fire Rated), M-Block (Mold/Moisture Resistant)

UFGS: Section 09 29 00 Gypsum Board
[http://www.wbdg.org/FFC/DOD/UFGS/UFGS 09 29 00.pdf](http://www.wbdg.org/FFC/DOD/UFGS/UFGS%2009%2029%2000.pdf)
Section 09 90 00 Paints and Coatings
[http://www.wbdg.org/FFC/DOD/UFGS/UFGS 09 90 00.pdf](http://www.wbdg.org/FFC/DOD/UFGS/UFGS%2009%2090%2000.pdf)

E04.1.5. Metal Panels

Applicable N/A

E04.1.6. Wood

Applicable N/A

E04.1.7. Rapidly-Renewable Products

Applicable N/A

E04.1.8. Other

Applicable N/A

E05. Doors and Windows

Comply with Air Force Corporate Standards for Doors and Windows:

<http://afcs.wbdg.org/facilities-interiors/doors-and-windows/index.html>

E05.1. Doors and Windows and Frames Materials

Facility Group 1

door (frame) and window frame materials shall be as follows.

Primary: Aluminum, clear anodized

Secondary: Hollow metal (painted)

Tertiary: N/A

Facility Group 1

door (leaf) materials shall be as follows.

Primary: Hardwood veneer

Secondary: Hollow metal (painted)

Tertiary: N/A

Facility Group 2

door (frame) and window frame materials shall be as follows.

Primary: Aluminum, clear anodized

Secondary: Hollow metal (painted)

Tertiary: N/A

Facility Group 2

door (leaf) materials shall be as follows.

Primary: Hardwood veneer

Secondary: Hollow metal (painted)

Tertiary: N/A

Facility Group 3

door (frame) and window frame materials shall be as follows.

Primary: Hollow metal (galvanized, painted)

Secondary: Hollow metal (galvanized)

Tertiary: N/A

Facility Group 3

door (leaf) materials shall be as follows.

Primary: Hollow metal (galvanized, painted)

Secondary: Hollow metal (galvanized)

Tertiary: N/A

Facility Group 4

door (frame) and window frame materials shall be as follows.

Primary: Wood

Secondary: N/A

Tertiary: N/A

Facility Group 4

door (leaf) materials shall be as follows.

Primary: Wood solid core

Secondary: Composite solid core

Tertiary: N/A

1. Hardwood casings may be provided over metal frames in Group 1 as approved on a case basis.
2. Paneled textured doors are preferred in Group 4.
3. Do not use hollow-core wood doors.
4. Generally match original hardware in renovations.
5. Manufacturers listed below are only provided to establish a baseline of equivalency among all applicable manufacturers.

Note: Apply the below *base-wide standards* for Doors and Windows (products, materials and color). Then refer to the Appendix and apply any additional requirements specifically related to the Facility District in which the project is located.

E05.1.1. Aluminum

Applicable N/A

Number of base standards 1



Type: **Style 1**

Applies to: Group 1 Group 2 Group 3 Group 4 Other

Mfr: Kawneer

Color: Clear anodized

Finish: Factory

Model #: InFrame Interior Framing, (2x4 nominal framing)

Other: Satin stainless steel hardware; Do not paint aluminum doors and frames.

UGFS: Section 08 41 13 Aluminum-Framed Entrances and Storefronts
<http://www.wbdg.org/FFC/DOD/UGFS/UGFS 08 41 13.pdf>
Section 08 71 00 Door Hardware
<https://www.wbdg.org/FFC/DOD/UGFS/UGFS 08 71 00.pdf>

E05.1.2. Hollow Metal

Applicable N/A

Number of base standards 2



Type: **Steel Doors**

Applies to: Group 1 Group 2 Group 3 Group 4 Other

Mfr: Steelcraft

Color: Neutral colors

Finish: Paint (Sheen per UFGS)

Model #: Hollow metal, 2" w. frames, 16 gauge (welded corners) grouted solid

Other: Provide in Group 3 and in utility areas of Group 1 and 2. Provide A25 "galvannealed" coating. All interior steel doors shall have a factory applied primer finish. Provide satin stainless steel hardware.

UGFS: Section 08 11 13 Steel Doors and Frames
<http://www.wbdg.org/FFC/DOD/UGFS/UGFS 08 11 13.pdf>
Section 08 71 00 Door Hardware
<https://www.wbdg.org/FFC/DOD/UGFS/UGFS 08 71 00.pdf>

Type: **Steel Frames**

Applies to: Group 1 Group 2 Group 3 Group 4 Other

Mfr: Steelcraft

Color: Neutral colors

Finish: Paint (Sheen per UFGS)

Model #: Hollow metal, frame grouted solid

Other: Satin stainless steel hardware

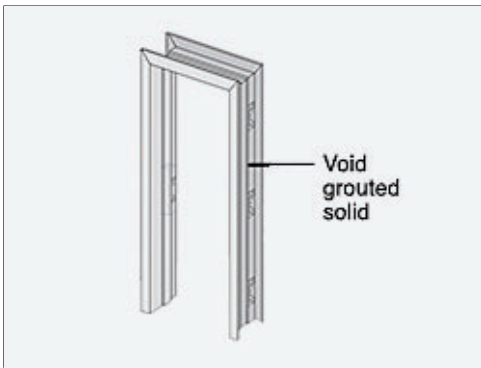

UFGS: Section 08 11 13 Steel Doors and Frames
<http://www.wbdg.org/FFC/DOD/UFGS/UFGS 08 11 13.pdf>
Section 08 71 00 Door Hardware
<https://www.wbdg.org/FFC/DOD/UFGS/UFGS 08 71 00.pdf>

E05.1.3. Wood

Applicable N/A Number of base standards 2

Type: **Style 1, Administrative**

Applies to: Group 1 Group 2 Group 3 Group 4 Other

Mfr: Simpson

Color: Natural hardwood veneer

Finish: Clear Sealer, satin (aqueous)

Model #: 3'x7'x 1 3/4", solid core

Other: Satin stainless steel hardware, Glass lites may be used. Stained birch veneer face, 5 ply construction, rotary cut finish.



UFGS: Section 08 14 00 Wood Doors
<http://www.wbdg.org/FFC/DOD/UFGS/UFGS 08 14 00.pdf>
Section 08 71 00 Door Hardware
<https://www.wbdg.org/FFC/DOD/UFGS/UFGS 08 71 00.pdf>

Type: **Style 2, Residential**



Applies to: Group 1 Group 2 Group 3 Group 4 Other

Mfr: Simpson

Color: Natural hardwood veneer

Finish: Clear Sealer or paint, satin (aqueous)

Model #: Full slab or panels

Other: Satin nickel hardware

UFGS: Section 08 14 00 Wood Doors

<http://www.wbdg.org/FFC/DOD/UFGS/UFGS 08 14 00.pdf>

Section 08 71 00 Door Hardware

<https://www.wbdg.org/FFC/DOD/UFGS/UFGS 08 71 00.pdf>

E05.1.4. Other

Applicable N/A

E06. Casework Systems

Comply with Air Force Corporate Standards for Casework Systems:

<http://afcfs.wbdg.org/facilities-interiors/casework-systems/index.html>

E06.1. Casework Materials

1. Select casework systems and materials considering durability, maintenance requirements and LCCA.
2. Natural stone and cast stone countertops may only be used in Group 1 with approval on a case basis.
3. Metal cabinets and countertops shall be provided in heavy-use operations and in Group 3.
4. Refer to AFCFS for approved materials.
5. Manufacturers listed below are only provided to establish a baseline of equivalency among all applicable manufacturers.

E06.1.1. Plastic Laminate

Applicable N/A Number of base standards 1



Type: **Style 1, Low Use Areas**

Applies to: Group 1 Group 2 Group 3 Group 4 Other

Mfr: Formica

Color: Medium Earth tones and neutral tones

Finish: Light textured

Model #: High pressure laminate

Other: Combine with matching solid-surface banding on casework edges.

UFGS: Section 06 41 16.00 10 Plastic-Laminate-Clad Architectural Cabinets
<http://www.wbdg.org/FFC/DOD/UFGS/UFGS 06 41 16.00 10.pdf>

E06.1.2. Solid Polymer Surface

Applicable N/A Number of base standards 1



Type: **Style 1, High Use Areas**

Applies to: Group 1 Group 2 Group 3 Group 4 Other

Mfr: Corian

Color: Medium Earth tones and neutral tones

Finish: Light textured

Model #: Solid Surface

Other: Faces and edge banding

UFGS: Section 12 36 00 Countertops
<http://www.wbdg.org/FFC/DOD/UFGS/UFGS 12 36 00.pdf>

E06.1.3. Rapidly-Renewable Products

Applicable N/A Number of base standards 1



Type: **Style 1 Moderate Use Areas**

Applies to: Group 1 Group 2 Group 3 Group 4 Other

Mfr: Plyboo

Color: Natural or amber

Finish: Satin

Model #: Flat grain bamboo plywood

Other: FSC® Certified 100%.

UFGS: Section 12 32 00 Manufactured Wood Casework
[http://www.wbdg.org/FFC/DOD/UFGS/UFGS 12 32 00.pdf](http://www.wbdg.org/FFC/DOD/UFGS/UFGS_12_32_00.pdf)

E06.1.4. Metal

Applicable N/A Number of base standards 1



Type: **Style 1**

Applies to: Group 1 Group 2 Group 3 Group 4 Other

Mfr: Steel Sentry

Color: Natural stainless steel or neutral colors (steel)

Finish: Mill (stainless) or Powder coated (steel)

Model #: Lab, workbench, computer workstation

Other: Provide highly durable fabrications and finishes in Group 3, which are subjected to heavy use.

UFGS: Section 12 31 00 Manufactured Metal Casework
[http://www.wbdg.org/FFC/DOD/UFGS/UFGS 12 31 00.pdf](http://www.wbdg.org/FFC/DOD/UFGS/UFGS_12_31_00.pdf)

E06.1.5. Other

Applicable N/A

E06.2. Countertop Materials

E06.2.1. Plastic Laminate

Applicable N/A Number of base standards 1



Type: **Style 1, Low Use Areas**

Applies to: Group 1 Group 2 Group 3 Group 4 Other

Mfr: Formica

Color: Medium Earth tones and neutral tones

Finish: Light textured

Model #: High pressure laminate

Other: Combine with matching solid-surface banding on countertop edges.

UFGS: Section 06 41 16.00 10 Plastic-Laminate-Clad Architectural Cabinets
http://www.wbdg.org/FFC/DOD/UFGS/UFGS_06_41_16.00_10.pdf

E06.2.2. Solid Polymer Surface

Applicable N/A Number of base standards 1



Type: **Style 1, High Use Areas**

Applies to: Group 1 Group 2 Group 3 Group 4 Other

Mfr: Corian

Color: Medium Earth tones and neutral tones

Finish: Light textured

Model #: Solid Surface

Other: Faces and edge banding

UFGS: Section 12 36 00 Countertops
http://www.wbdg.org/FFC/DOD/UFGS/UFGS_12_36_00.pdf

E06.2.3. Natural Stone

Applicable N/A Number of base standards 1



Type: **Style 1, Group 1 High Visibility, Heavy Use**

Applies to: Group 1 Group 2 Group 3 Group 4 Other

Mfr: Local (TBD)

Color: Neutral tones

Finish: High polish, sealer

Model #: Custom cut slabs

Other: N/A

UFGS: Section 12 36 00 Countertops
[http://www.wbdg.org/FFC/DOD/UFGS/UFGS 12 36 00.pdf](http://www.wbdg.org/FFC/DOD/UFGS/UFGS_12_36_00.pdf)

E06.2.4. Cast Stone

Applicable N/A Number of base standards 1

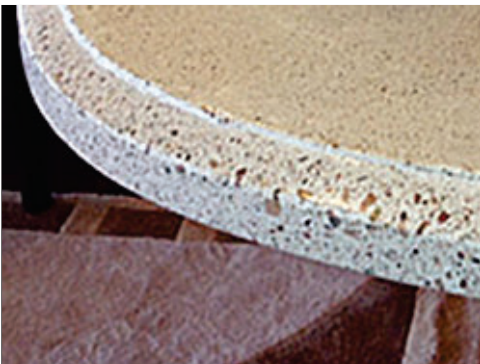

Type: **Style 1, Group 1 High Visibility, Heavy Use**

Applies to: Group 1 Group 2 Group 3 Group 4 Other

Mfr: Local (TBD)

Color: Neutral tones

Finish: High polish, sealer

Model #: Custom cut slabs or custom cast

Other: N/A

UFGS: Section 12 36 00 Countertops
[http://www.wbdg.org/FFC/DOD/UFGS/UFGS 12 36 00.pdf](http://www.wbdg.org/FFC/DOD/UFGS/UFGS_12_36_00.pdf)

E06.2.5. Metal

Applicable N/A

Number of base standards 1



Type: **Style 1**

Applies to: Group 1 Group 2 Group 3 Group 4 Other

Mfr: Local (TBD)

Color: Natural stainless steel

Finish: Mill

Model #: Custom fabricated countertops

Other: Provide integral fronts, sides and backsplash

UFGS: Section 12 31 00 Manufactured Metal Casework
<http://www.wbdg.org/FFC/DOD/UFGS/UFGS 12 31 00.pdf>

E06.2.6. Other

Applicable N/A

E07. Furnishings

Comply with Air Force Corporate Standards for Furnishings:
<http://afcfs.wbdg.org/facilities-interiors/furnishings/index.html>

E07.1. Durability and Serviceability

Comply with AF Corporate Standards for Durability and Serviceability:
<http://afcfs.wbdg.org/facilities-interiors/furnishings/durability-and-serviceability/index.html>

E07.2. Accessories

Comply with AF Corporate Standards for Accessories:
<http://afcfs.wbdg.org/facilities-interiors/furnishings/accessories/index.html>

E08. Interior Signs

Comply with Air Force Corporate Standards for Interior Signs:
<http://afcfs.wbdg.org/facilities-interiors/interior-signs/index.html>

E08.1 Types and Color

Comply with Air Force Corporate Standards for Types and Color:
<http://afcfs.wbdg.org/facilities-interiors/interior-signs/types-and-color/index.html>

E08.2. Interior Signs Materials

1. Natural stone, masonry and cast stone signs may only be used in Group 1 with approval on a case-by-case basis.

E09. Lighting, Power and Communication

<http://afcfs.wbdg.org/facilities-interiors/lighting-power-and-communication/index.html>

E09.1. Functionality and Efficiency

Comply with Air Force Corporate Standards for Functionality and Efficiency:
<http://afcfs.wbdg.org/facilities-interiors/lighting-power-and-communication/functionality-and-efficiency/index.html>

E09.2. Types and Color

Interior Lighting:

1. All Interior lights shall be LED (light-emitting diode). Interior illumination levels typically range from 15-35 foot candles, adjusted higher or lower depending upon the use of the space.

Power and Grounding System:

Comply with Air Force instruction for Grounding and Bonding:

https://www.wbdg.org/FFC/AF/AFI/afi_32_1065_2017.pdf

1. All conductors shall be copper and shall meet the requirements of NFPA and NEC.
2. Electrical system shall be grounded.

Emergency Generator:

Comply with Air Force Instruction for Power Plants and Generators:

https://www.wbdg.org/FFC/AF/AFI/afi_32_1062.pdf

1. Provide double wall saddle tanks that are part of a package installation for generator installations. The fuel type shall be diesel.

Fire Protection:

Comply with Air Force Instruction for Fire Emergency Services

https://www.wbdg.org/FFC/AF/AFI/afi_32_2001.pdf

https://www.wbdg.org/FFC/DOD/UFC/ufc_4_021_01_2008_c1.pdf

F. APPENDIX - Facility Districts

Applicable

N/A

Comply with Air Force Corporate Standards for Facility Districts:

<http://afcs.wbdg.org/facility-districts/index.html>

Facilities Districts Overview Map:

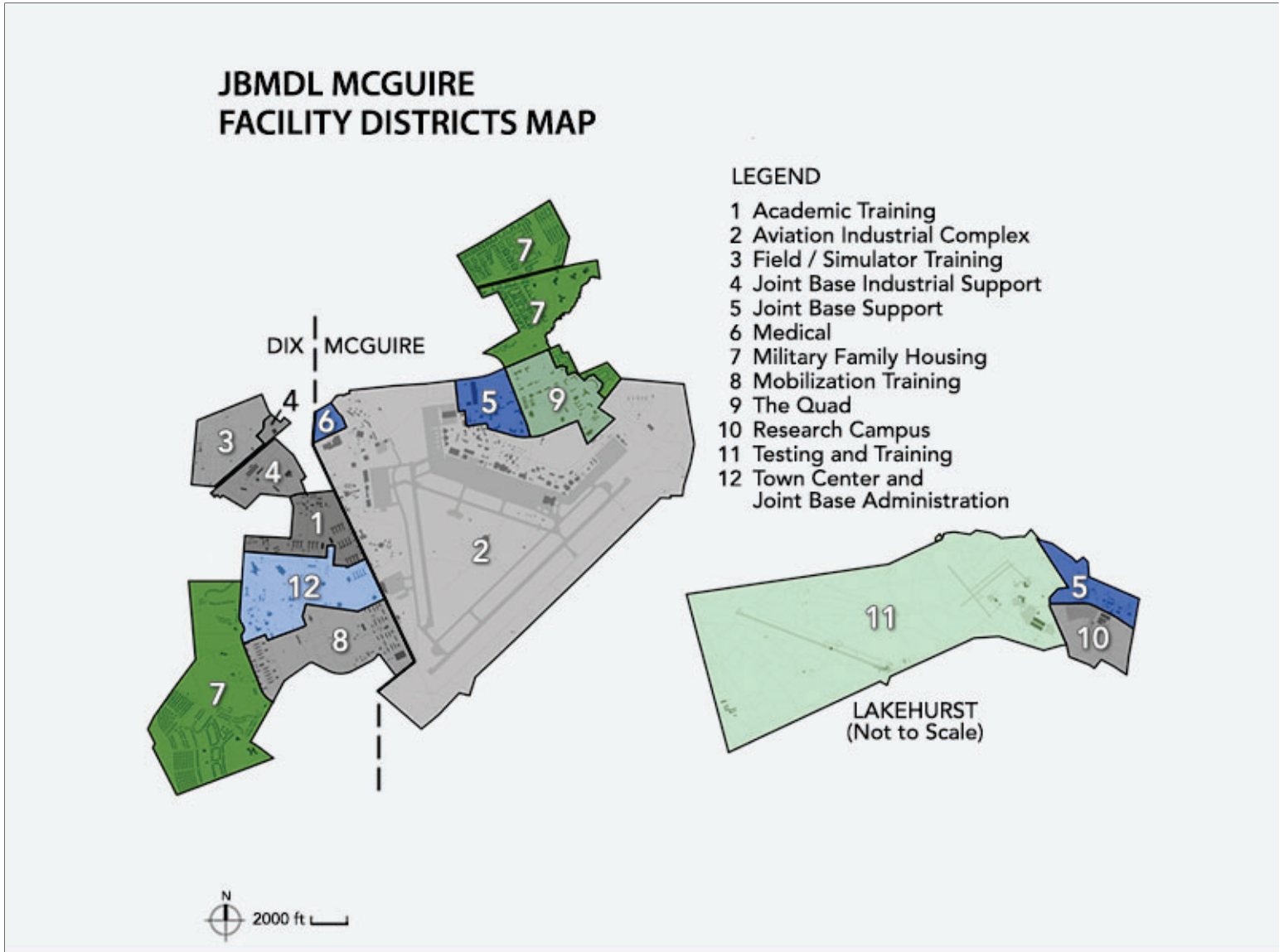

Note: Apply the base-wide standards in this IFS for Installation Elements, Site Development, Facilities Exteriors and Facilities Interiors (products, materials, color, etc.). Following application of the base-wide standards, refer to the Appendix and apply any additional requirements specifically related to the Facility District.

Enter No. of Facility Districts 1

The following Facility Districts list exceptions to the base standards that are unique to each district. Please refer to the Site Development, Facilities Exteriors, and Facilities Interiors sections of this IFS for base standards.

Map of District

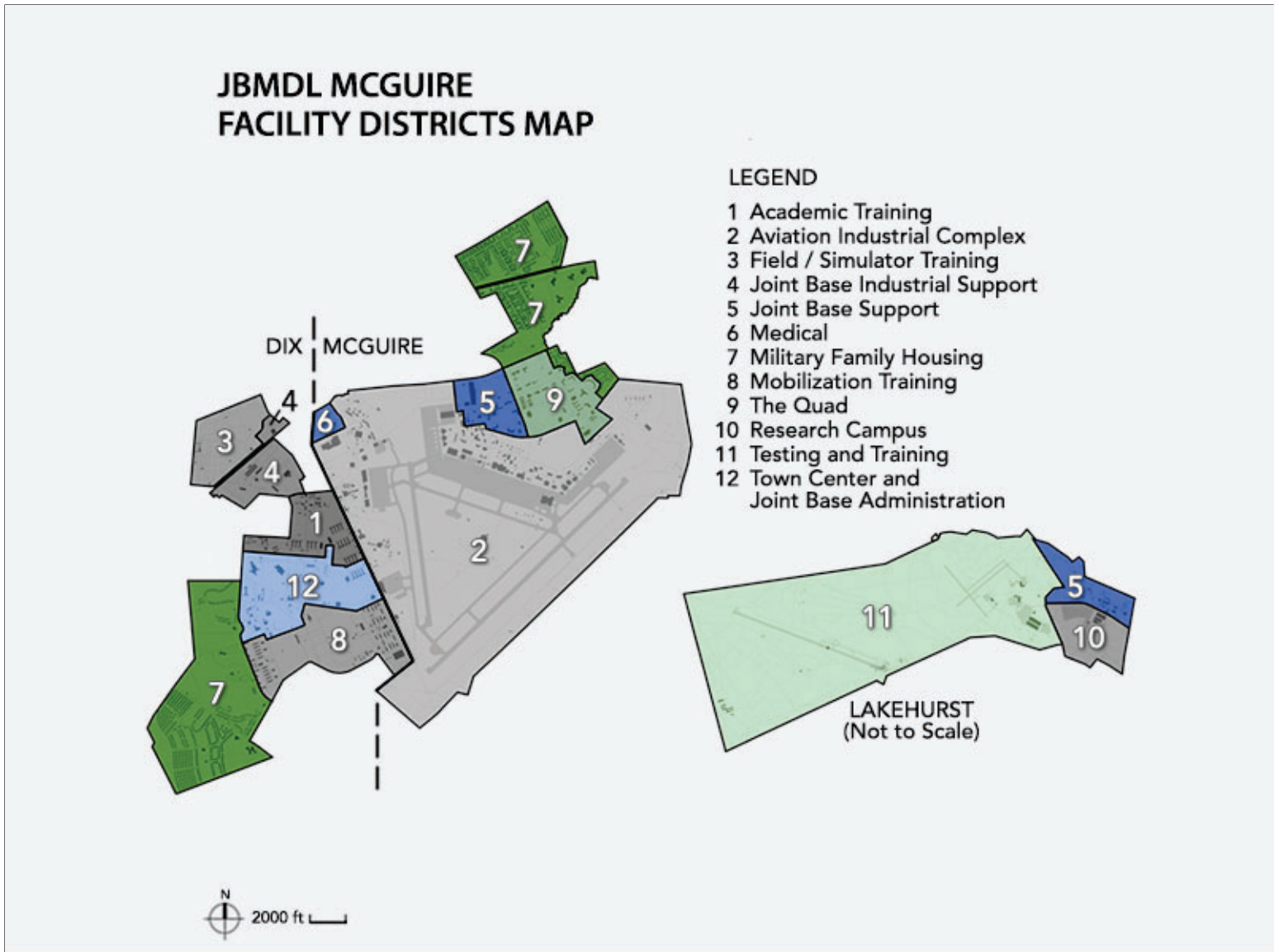

Photos for each facility group within the Facility District as applicable.

Group 1 Applicable N/A

Group 2 Applicable N/A

Group 3 Applicable N/A

Group 4 Applicable N/A

Other Applicable N/A

FACILITY DISTRICTS

JBMDL McGuire is divided into districts that align with land use zones as defined in the installation's General Plan. Each district has designated uses that support the base's operations. Generally match adjacent facilities in new construction to promote architectural compatibility throughout the installation. Please refer to Section D03.2. and contact the Base Civil Engineer for additional information. Districts for all three of the joint bases are listed below. A brief description of districts that are applicable to JBMDL McGuire follows.

1. Academic Training
2. Aviation Industrial Complex
3. Field I Simulator Training
4. Joint Base Industrial Support
5. Joint Base Support
6. Medical
7. Military Family Housing
8. Mobilization Training
9. The Quad
10. Research Campus
11. Testing and Training
12. Town Center and Joint Base Administration

1. Not Applicable to JBMDL McGuire

2. Aviation Industrial Complex

The Aviation Industrial Complex District may be monumental in scale with pedestrian-scaled architectural features. Application of the installation prevailing architectural theme, regional vernacular, should be implemented during major renovations or new construction as appropriate. Facilities in this district are industrial in nature, should generally match adjacent buildings to ensure architectural compatibility, and shall follow standards for Facility Group 3 as defined in this IFS. While there are a number of grandfathered support facilities within any district, all new facilities should adhere to the standards described within this document and the broader Installation Development Plan unless otherwise excepted.

3. Not Applicable to JBMDL McGuire

4. Not Applicable to JBMDL McGuire

5. Joint Base Support

Facilities in the Joint Base Support District should continue to be pedestrian in scale. Application of the installation prevailing architectural theme, regional vernacular, should be implemented during major renovations or new construction as appropriate. Facilities in this district are administrative in nature, should generally match adjacent buildings to ensure architectural compatibility, and shall follow standards for Facility Groups 1 and 2 as defined in this IFS. While there are a number of grandfathered support facilities within any district, all new facilities should adhere to the standards described within this document and the broader Installation Development Plan unless otherwise excepted.

6. Medical

Facilities in the Medical District should continue to be pedestrian in scale. Application of the installation prevailing architectural theme, regional vernacular, should be implemented during major renovations or new construction as appropriate. Facilities in this district are administrative and institutional in nature, should generally match adjacent buildings to ensure architectural compatibility, and shall follow standards for Facility Group 1 as defined in this IFS. While there are a number of grandfathered support facilities within any district, all new facilities should adhere to the standards described within this document and the broader Installation Development Plan unless otherwise excepted.

7. Military Family Housing

The Family Housing District consists of detached single family residential units occupied by enlisted and officer families. This area is currently under a housing privatization contract, but shall follow standards for Facility Group 4 as defined in this IFS. While there are a number of grandfathered support facilities within any district, all new facilities should adhere to the standards described within this document and the broader Installation Development Plan unless otherwise excepted.

8. Not Applicable to JBMDL McGuire

9. The Quad

Facilities in The Quad District should continue to be pedestrian in scale. Application of the installation prevailing architectural theme, regional vernacular, should be implemented during major renovations or new construction as appropriate. Facilities in this district are educational in nature, should generally match adjacent buildings to ensure architectural compatibility, and shall follow standards for Facility Groups 2 as defined in this IFS. While there are a number of grandfathered support facilities within any district, all new facilities should adhere to the standards described within this document and the broader Installation Development Plan unless otherwise excepted.

10. Not Applicable to JBMDL McGuire

11. Not Applicable to JBMDL McGuire

12. Not Applicable to JBMDL McGuire

G. APPENDIX - References

Comply with Air Force Corporate Standards:

<http://afcs.wbdg.org/index.html>