

# FAIRCHILD AIR FORCE BASE INSTALLATION FACILITIES STANDARDS (IFS)



Installation Elements



Site Development



Facilities Exteriors



Facilities Interiors

**APPROVED FOR PUBLIC RELEASE; DISTRIBUTION UNLIMITED**

Signature Field

**Fairchild Air Force Base IFS**

**Table of Contents**

<b>A. OVERVIEW</b> .....	5	B03.2.3. Preserves	
A01. Facility Hierarchy .....	5	B03.2.4. Perimeter Fence	
A02. Facility Quality .....	5	<b>C. SITE DEVELOPMENT</b> .....	23
A03. Facility Districts .....	5	C01. Site Design .....	23
<b>B. INSTALLATION ELEMENTS</b> .....	7	C01.1. Site Design Considerations .....	23
B01. Comprehensive Planning .....	7	C01.2. Building Orientation .....	24
B01.1. Installation Development Plan (IDP) .....	7	C02. Utilities .....	25
B01.1.1. IFS Component Plan of IDP		C02.1. Utility Components .....	26
B01.1.2. Brief History of Base		C03. Parking Areas .....	26
B01.1.3. Future Development		C03.1. Configurations and Design .....	27
B02. Street Envelope Standards .....	9	C03.1.1. Paving and Striping	
B02.1. Hierarchy of Streets .....	9	C03.1.2. Curbing	
B02.1.1. Arterial Streets		C03.1.3. Internal Islands and Medians	
B02.1.2. Collector Streets		C03.2. Parking Structures .....	30
B02.1.3. Local Streets		C03.3. Connectivity .....	30
B02.1.4. Special Routes		C04. Stormwater Management .....	30
B02.2. Hierarchy of Intersections .....	14	C04.1. Stormwater Requirements .....	30
B02.2.1. Arterials		C05. Sidewalks, Bikeways and Trails .....	31
B02.2.2. Arterial/Collector		C05.1. Circulation and Paving .....	31
B02.2.3. Collectors		C05.1.1. Ramps and Stairs	
B02.2.4. Special Intersections		C05.1.2. Lighting	
B02.2.5. Street Frontage Requirements		C06. Landscape .....	33
B02.2.6. Sight Lines		C06.1. Climate-based Materials .....	33
B02.3. Street Elements .....	15	C06.1.1. Landscape Design Concept	
B02.3.1. Paving		C06.1.2. Xeriscape Design Principles	
B02.3.2. Curb and Gutter		C06.1.3. Minimizing Water Requirements	
B02.3.3. Utility Service Elements		C06.1.4. Plant Material Selection	
B02.3.4. Traffic Signs		C06.1.5. Water Budgeting (Hydrozones)	
B02.3.5. Street Lighting		C06.1.6. Base Entrance Landscaping	
B02.3.6. Other		C06.1.7. Streetscape Landscaping	
B03. Open Space / Public Space .....	17	C06.1.8. Pedestrian Circulation Landscaping	
B03.1. Plazas, Monuments and Static Displays .....	18	C06.1.9. Parking Lot Landscaping	
B03.1.1. Paved Plazas		C06.1.10. Screen/Accent Landscaping	
B03.1.2. Sculptures, Markers and Statuary		C06.1.11. Other	
B03.1.3. Static Display of Aircraft		C07. Site Furnishings .....	40
B03.2. Grounds and Perimeters .....	20	C07.1. Furnishings and Elements .....	40
B03.2.1. Parade Grounds			
B03.2.2. Parks			



Table of contents continued

C07.2. Site Furnishings Products, Materials / Color ..	42	D03.3.4. Thermal Shading	
C07.2.1. Barbeque Grills		D03.3.5. Renewable Heating/Cooling	
C07.2.2. Benches		D03.3.6. Solar Photovoltaic System	
C07.2.3. Bike Racks		D03.3.7. Solar Thermal System	
C07.2.4. Bike Lockers		D04. Building Entrances .....	73
C07.2.5. Bollards		D04.1. Primary Entrances .....	74
C07.2.6. Bus Shelters		D04.2. Secondary Entrances .....	74
C07.2.7. Drinking Fountains		D05. Wall Systems .....	75
C07.2.8. Dumpster Enclosures / Gates		D05.1. Hierarchy of Materials .....	76
C07.2.9. Fencing		D05.2. Layout, Organization and Durability .....	76
C07.2.10. Flagpoles		D05.3. Equipment, Vents and Devices .....	77
C07.2.11. Lighting – Landscape / Accent		D05.4 Wall Systems Materials .....	77
C07.2.12. Litter and Ash Receptacles		D05.4.1. Flat Metal Panels	
C07.2.13. Picnic Tables		D05.4.2. Brick Veneer	
C07.2.14. Planters – Free Standing		D05.4.3. Architectural Precast	
C07.2.15. Play Equipment		D05.4.4. Stucco Over Sheathing	
C07.2.16. Screen Walls		D05.4.5. Curtain Wall	
C07.2.17. Tree Grates		D05.4.6. Cast-in Place Concrete	
C07.2.18. Other		D05.4.7. Tilt-up Concrete	
C08. Exterior Signs .....	51	D05.4.8. Ribbed Metal Sheeting	
C08.1. Colors and Types .....	52	D05.4.9. EFIS	
C08.1.1. Materials and Color Specifications		D05.4.10. GRFC	
C08.1.2. Installation and Gate Identification Signs		D05.4.11. Concrete Block	
C08.1.3. Building Identification Signs		D05.4.12. Fiber Cement Siding	
C08.1.4. Traffic Control Devices (Street Signs)		D05.4.13. Other	
C08.1.5. Directional and Wayfinding Signs		D06. Doors and Windows .....	82
C08.1.6. Informational Signs		D06.1. Types .....	83
C08.1.7. Motivational Signs		D06.2. Layout and Geometry .....	83
C08.1.8. Parking Lot Signs		D06.3. Glazing and Shading .....	83
C08.1.9. Regulatory Signs		D06.4. Hardware .....	84
C08.1.10. Other		D06.5. Doors and Windows Materials .....	84
C09. Lighting .....	58	D06.5.1. Anodized Aluminum	
C09.1. Fixtures and Lamping .....	59	D06.5.2. Hollow Metal	
C09.2. Light Fixture Types .....	60	D06.5.3. Aluminum-clad Wood	
C09.2.1. Street Lighting		D06.5.4. Other	
C09.2.2. Parking Lot Lighting		D07. Roof Systems .....	86
C09.2.3. Lighted Bollards		D07.1. Roof Type and Form .....	87
C09.2.4. Sidewalk Lighting		D07.2. Roof Slope .....	87
C09.2.5. Walls / Stairs Lighting		D07.3. Parapets and Copings .....	88
C09.2.6. Other		D07.4. Color and Reflectivity .....	88
<b>D. FACILITIES EXTERIORS .....</b>	<b>65</b>	D07.5. Gutters, Downspouts, Scuppers, Drains .....	88
D01. Supporting the Mission .....	65	D07.6. Roof Vents and Elements .....	89
D02. Sustainability .....	65	D07.7. Clerestories and Skylights .....	89
D03. Architectural Features .....	66	D07.8. Vegetated Roof .....	89
D03.1. Orientation, Massing and Scale .....	67		
D03.2. Architectural Character .....	67		
D03.3. Details and Color .....	67		
D03.3.1. Climate-based Data			
D03.3.2. Natural Ventilation System			
D03.3.3. Thermal Mass			

Table of contents continued

D07.9. Roof Systems Materials .....	89	E04. Ceilings .....	108
D07.9.1. Standing Seam Metal		E04.1. Ceiling Materials .....	108
D07.9.2. Membrane Single-ply		E04.1.1. Exposed Framing (Roof / Floor Structure	
D07.9.3. Built-up Multi-ply		Above)	
D07.9.4. Concrete Tile		E04.1.2. Exposed Concrete	
D07.9.5. Clay Tile		E04.1.3. Grid and Acoustical Tile	
D07.9.6. Slate Shingles		E04.1.4. Gypsum Board	
D07.9.7. Vegetated System		E04.1.5. Metal Panels	
D07.9.8. Ribbed Metal Sheeting		E04.1.6. Wood	
D07.9.9. Composite Shingles		E04.1.7. Rapidly-Renewable Products	
D07.9.10. Other		E04.1.8. Other	
D08. Structural Systems .....	92	E05. Doors and Windows .....	111
D08.1. Systems and Layouts .....	93	E05.1. Doors and Windows and Frames Materials ....	111
D08.2. Structural Systems Materials .....	93	E05.1.1. Aluminum	
D08.2.1. Concrete		E05.1.2. Hollow Metal	
D08.2.2. Insulated Concrete Forming (ICF)		E05.1.3. Wood	
D08.2.3. Steel		E05.1.4. Other	
D08.2.4. Pre-Engineered Steel		E06. Casework Systems .....	115
D08.2.5. Masonry		E06.1. Casework Materials .....	115
D08.2.6. Heavy Timber		E06.1.1. Plastic Laminate	
D08.2.7. Light-gauge Steel		E06.1.2. Solid Polymer Surface	
D08.2.8. Lumber Framing		E06.1.3. Rapidly-Renewable Products	
D08.2.9. Other		E06.1.4. Metal	
D09. Mechanical, Electrical and Plumbing .....	96	E06.2. Countertop Materials .....	117
D09.1. Passive and Active Systems .....	97	E06.2.1. Plastic Laminate	
D09.2. Functionality and Efficiency .....	97	E06.2.2. Solid Polymer Surface	
<b>E. FACILITIES INTERIORS .....</b>	<b>98</b>	E06.2.3. Natural Stone	
E01. Building Configurations .....	99	E06.2.4. Cast Stone	
E01.1. Layout and Common Areas .....	99	E06.2.5. Metal	
E01.1.1. Interior Design Process		E07. Furnishings .....	120
E01.1.2. Codes and Regulations		E07.1. Durability and Serviceability .....	120
E01.2. Quality and Comfort .....	101	E07.2. Accessories .....	120
E02. Floors .....	101	E08. Interior Signs .....	120
E02.1. Floor Materials .....	101	E08.1 Types and Color .....	120
E02.1.1. Prepared Slabs		E08.2. Interior Signs Materials .....	120
E02.1.2. Natural Stone and Terrazzo		E09. Lighting, Power and Communication .....	120
E02.1.3. Quarry Tile		E09.1. Functionality and Efficiency .....	121
E02.1.4. Ceramic Tile		E09.2. Types and Color .....	121
E02.1.5. Resilient Floor		<b>F. Appendices .....</b>	<b>122</b>
E02.1.6. Carpet		<b>G. Appendices .....</b>	<b>122</b>
E02.1.7. Rapidly-Renewable Products			
E02.1.8. Other			
E03. Walls .....	105		
E03.1. Wall Materials .....	105		
E03.1.1. Concrete			
E03.1.2. Masonry			
E03.1.3. Ceramic Tile			
E03.1.4. Gypsum Board			
E03.1.5. Metal Panels			
E03.1.6. Wood Paneling			
E03.1.7. Rapidly-Renewable Products			
E03.1.8. Other			

## A. OVERVIEW

Comply with Air Force Corporate Standards for Overview:

<http://afcfs.wbdg.org/index.html>

This Installation Facilities Standards (IFS) document is part of the Air Force Corporate Facilities Standards (AFCFS) program to assist bases in implementing and maintaining facilities standards as appropriate for efficient operations within the respective climate region. IFS fully replaces, consolidates and simplifies existing facilities standards documents, such as the Architectural Compatibility Plan (ACP) or ACGs, FEPs, etc., and organizes information using the same structure, or Table of Contents, as the AFCFS website.

IFS reflects the AFCFS' concepts of "Facility Hierarchy" (categorizing facilities into group numbers) and "Facility Quality" (assigning an appropriate level of quality to each group number) and applies these principles at the base level. Applicable DoD and Air Force criteria such as UFCs, AFIs, Memoranda, and UFGSs (Guide Specs) are referenced and linked within IFS to ensure the document is always current.

Navigating within this IFS is efficient and straightforward. Please use the interactive Table of Contents to locate subject matter, and click on the title of a section to access it. From any page, click on the "Back to Table of Contents" footer to return. Content is organized into 4 major sections: Installation Elements, Site Development, Facilities Exteriors and Facilities Interiors.

This IFS document begins as a fill-in PDF form, which is fully editable, and becomes a "living document" that can be regularly updated by base-level personnel following a format that is consistent across the Air Force. While the format is standardized, IFS content is customized for base operations and the local climate to ensure mission success while emphasizing reduced maintenance and reduced initial costs, life-cycle costs, energy use, and water use.

1. Conformance to Air Force Corporate Facilities Standards (AFCFS) and Installation Facilities Standards (IFS) are required by Air Force Instruction (AFI) 32-1023 and Air Force Memorandum. Please refer to the AFCFS website for links to documentation on current policy.
2. The IFS is a component plan of the Installation Development Plan (IDP) per Air Force Instruction (AFI) 32-7062 (replacing the Architectural Compatibility Plan). All military construction projects and Non-Appropriated Funds (NAF) facilities are required to comply with the IDP and its IFS component plan by AFI 32-1023. The Base Civil Engineer (BCE) maintains and implements the IDP and its component plans, to include the IFS.
3. Please refer to the AFCFS website as a portal to reference materials and requirements documents for design and construction projects (via links). Specific references to current DoD memoranda and Air Force criteria are updated periodically to provide the most current guidance and requirements. Programming, design and contract documents should list "current edition" for all reference and requirements documents. The documents in force at the date of execution of the design and/or construction contract shall be the governing version.
4. *Advanced Modeling Requirements:*  
*For all Air Force projects requiring advanced modeling, to include 3D visualization, Building Information Modeling (BIM), facility data, quantity take-off, geospatial, etc., follow the Army standards. Refer to USACE Minimum Model Matrix (M3) and Project Execution Plan (PxP) which outline required model uses. Refer to [CAD BIM Technology Center \(Contract Requirements\)](#) for more information on M3 and PxP.*
5. Joint Bases shall implement IFS under their Joint-Base designation with volume numbers for individual installations following the IFS Development Tool template. For example, for Joint Base Langley-Eustis, provide: Vol. 1 Langley AFB and Vol. 2 Fort Eustis.

### A.01. FACILITY HIERARCHY

Comply with AF Corporate Standards for Facility Hierarchy (and subsections):

<http://afcfs.wbdg.org/facility-hierarchy/index.html>

### A.02. FACILITY QUALITY

Comply with AF Corporate Standards for Facility Quality (and subsections):

<http://afcfs.wbdg.org/facility-quality/index.html>

### A.03. FACILITY DISTRICTS

Comply with AF Corporate Standards for Facility Districts (and subsections):

<http://afcfs.wbdg.org/facility-districts/index.html>

Image Tool 800 x 800

# FAIRCHILD AFB FACILITY DISTRICTS MAP

## LEGEND

- 1 Basewide
- 2 Brown Brick
- 3 Flightline/Industrial
- 4 Family Housing

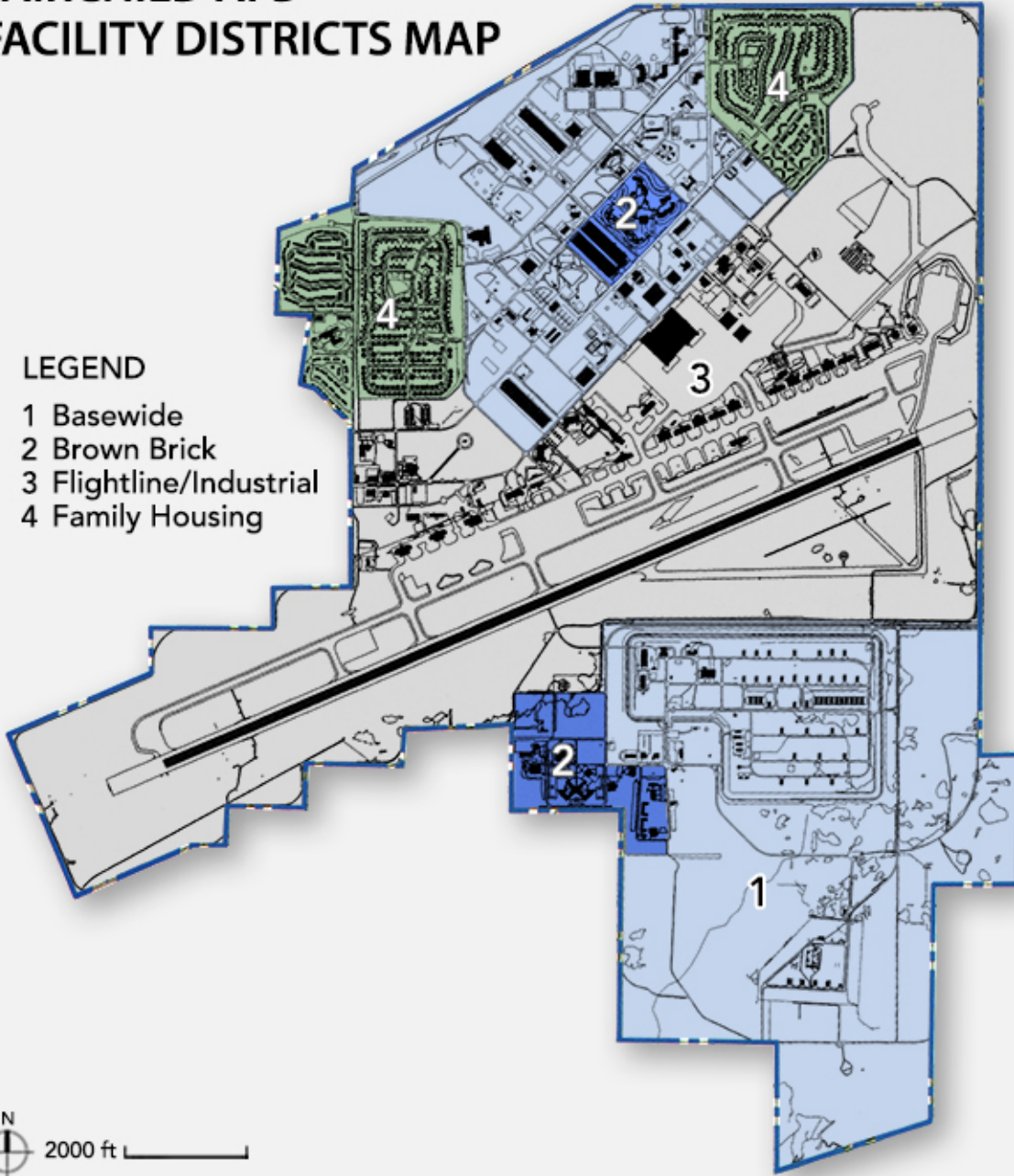

**Note:** Apply the base-wide standards in this IFS for Installation Elements, Site Development, Facilities Exteriors and Facilities Interiors (products, materials, color, etc.). Following application of the base-wide standards, refer to the Appendix and apply any additional requirements specifically related to the Facility District.

## B. INSTALLATION ELEMENTS

Comply with Air Force Corporate Standards for Installation Elements:  
<http://afcs.wbdg.org/installation-elements/index.html>

### B.01. COMPREHENSIVE PLANNING

Comply with Air Force Corporate Standards for Comprehensive Planning:  
<http://afcs.wbdg.org/installation-elements/comprehensive-planning/index.html>

#### B01.1. Installation Development Plan (IDP)

Applicable  N/A Select number of graphics / images (large: 800 px x 440 px) to insert 1

Image Tool 800 x 440

Applicable  N/A Small graphics do not apply

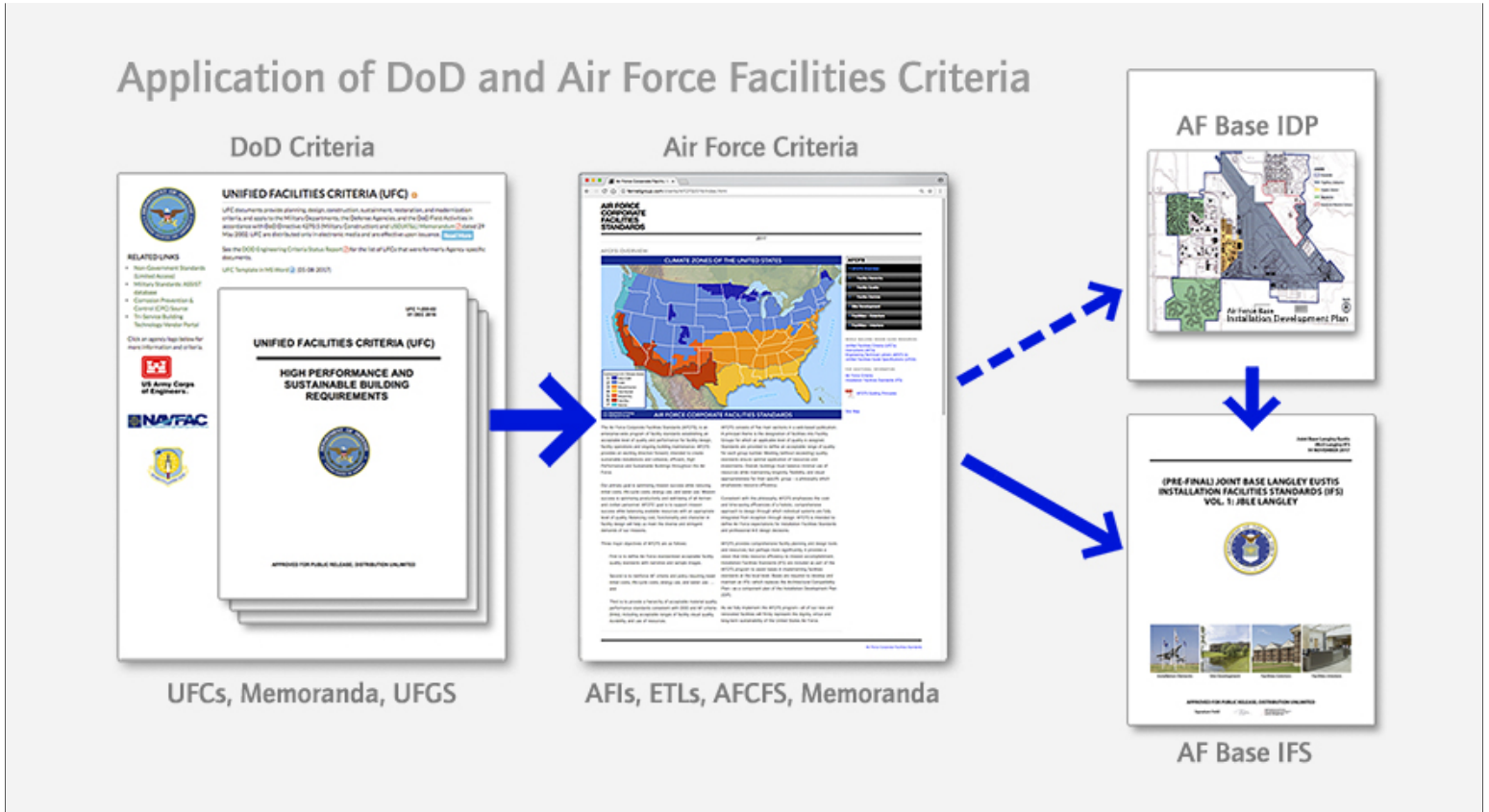

Department of Defense, Department of the Air Force and Air Force Base Criteria

1. The Base Civil Engineer is responsible for developing, maintaining and implementing the installation's Comprehensive Planning documents and to ensure that the Installation Development Plan (IDP) is prepared, maintained, and implemented following AFI 32-7062. The base is also required to provide and maintain Installation Facilities Standards (IFS) as a Component Plan of the base's Installation Development Plan (IDP).

#### B01.1.1. IFS Component Plan of IDP

Applicable  N/A Large graphics do not apply

Applicable  N/A Small graphics do not apply

The IFS is a multipurpose tool that shall be used throughout the entire planning, programming, and design process, from inception to project completion for any project on base. While architectural designers are the primary users of the plan, it must



also be used by project managers, programmers, planners, engineers, maintenance and operations personnel, self-help personnel, and the Architectural Compatibility Review Board (ACRB). Any items purchased for the exterior of buildings - including those purchased with impact cards - must conform to the requirements prescribed in the IFS.

Fairchild AFB has a foundation for architectural unity. The existing architecture depicts a predominant materials palette and a consistency of material detailing. The following design standards are applicable to the entire installation, to both host and tenant organizations.

The goal is to design excellent facilities that satisfy all of these priorities: The first priority is to achieve architectural compatibility for Fairchild Air Force Base as a whole. The second priority is compatibility within an architectural setting or sub-area. Outstanding designs for individual buildings or facilities are the third priority.

Site planning and site development issues contribute significantly to the architectural context. Building setbacks and the scale and definition of space are as fundamental to creating architectural compatibility as consistent facade designs. Develop exterior spaces to promote pedestrian use and activity and to connect buildings and the landscape. Use the landscape with other visual elements to create greater continuity.

**About the Architectural Compatibility Review Board (ACRB):**

- The ACRB is the installation approval authority for all designs and visual features on the installation. Projects with design features or proposals that compete with standards or methods as prescribed by the IFS or would otherwise establish a new precedent, require ACRB approval.
- The ACRB is organized by the Base Civil Engineer (BCE).
- The chair person as appointed.
- Members include the base architects, community planner, engineering flight chief, operations flight chief, project manager, and others as determined by the chair person.
- The base architect, engineering disciplines, and project manager review designs regardless of ACRB involvement.
- The ACRB meets as required.
- Most projects, regardless of size, must be approved by the ACRB. (The chairperson makes the determination on review requirements).
- Design projects are submitted to the ACRB by the base-assigned project manager

**B01.1.2. Brief History of Base**

Applicable  N/A Large graphics do not apply

Applicable  N/A Select number of graphics / images (small: 250 px x 188 px) to insert 3

Image Tool 250 x 188



The arrival of Gen. Fairchild



Gen. Fairchild Portrait Unveiling



Dedication Ceremony, 1951

Since 1942, Fairchild Air Force Base has been an integral part of our nation's defense strategy; first as a key WWII repair and supply depot, then as a Strategic Air Command bomber, tanker and ICBM wing during the Cold War and, finally, as an Air Mobility Command air refueling wing supporting contingency operations around the world. Today, Fairchild's aircraft and personnel make up the backbone of the Air Force's tanker fleet on the west coast. This Center of Excellence for Air Refueling is the home of the Air



Force's premier tanker base and survival training school house. However, it must be noted that it was the vision of Spokane's city leaders and the support of the people of Spokane that made the base a reality.

The 92d Air Refueling Wing, the 141st Air Refueling Wing, the 336th Training Group, and the associate units at Fairchild, and the Spokane community have forged an impressive relationship over the years. This team, "Team Fairchild," has earned a well-deserved reputation for excellence. Team Fairchild will continue to meet future challenges in its usual fashion, and in so doing will preserve the legacy of excellence that began over 75 years ago by providing responsive, precise air refueling and operational support for a full range of military operations.

### **B01.1.3. Future Development**

Applicable  N/A Large graphics do not apply

Applicable  N/A Small graphics do not apply

1. Follow AFI 32-7062 for Air Force Comprehensive Planning, the Comprehensive Planning Process, Comprehensive Planning Requirements, and Geospatial Mapping.
2. Address all future development under the Installation Development Plan (IDP).

## **B02. STREET ENVELOPE STANDARDS**

Comply with Air Force Corporate Standards for Installation Elements:

<http://afcfs.wbdg.org/installation-elements/index.html>

Comply with AF Corporate Standards for Street Envelope Standards:

<http://afcfs.wbdg.org/installation-elements/street-envelope-standards/index.html>

### **B02.1. Hierarchy of Streets**

Applicable  N/A Large graphics do not apply

Applicable  N/A Small graphics do not apply

1. Develop and evolve a hierarchical transportation network of arterial, collector and local streets following UFC 3-201-01 and its industry references.
2. Provide consistent functionality throughout the installation and a level of visual quality relating to the adjacent Facility Group number.
3. Routes along facilities in Group 1 may have materials, finishes and features with a higher visual quality than Groups 2, 3 and 4. Reduce maintenance requirements by installing highly durable materials and finishes in routes along Group 3 industrial facilities.
4. Special routes may have a visual quality comparable to those along facilities in Group 1.
5. Create and maintain arterials with two lanes of traffic in each direction with landscaped or paved medians as applicable to the local climate and adjacent facility group designation / land use.
6. Minimize stops and turns along arterials. Eliminate on-street parking along arterials and collector streets.
7. Connect arterials to local streets with appropriately scaled collector streets.
8. Provide appropriate landscape setbacks and pedestrian buffers along all streets.
9. Minimize and consolidate curb cuts along streets.

10. Ensure access for emergency and service vehicles.

11. Define bicycle traffic routes in the Installation Development Plan or its applicable component plans.

12. Define appropriate force protection features, site furnishings, signs, lighting, utilities, and paving in the IFS.

### B02.1.1. Arterial Streets

Applicable  N/A Select number of graphics / images (large: 800 px x 440 px) to insert 1

Image Tool 800 x 440

Applicable  N/A Select number of graphics / images (small: 250 px x 188 px) to insert 1

Image Tool 250 x 188

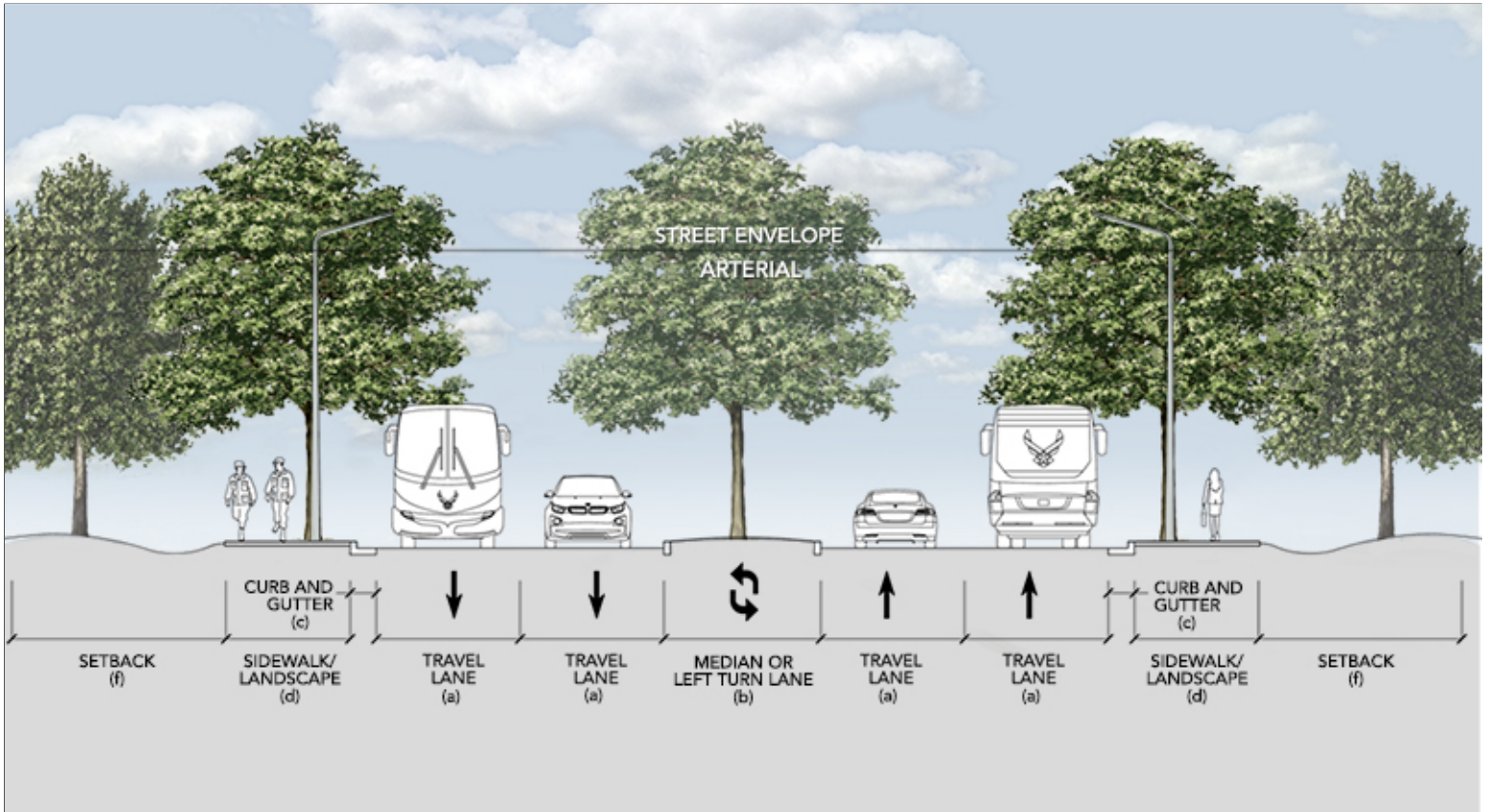

Travel Lane (a): 12' Median (b): 12' Curb and Gutter (c): 2' Sidewalk / Landscape (d): 12' Setback (f): Min. 35' or per ATFP

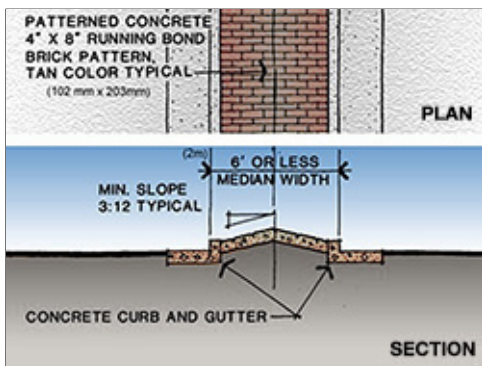

Paved Median

Primary roadways are developed as boulevards and contain two lanes of traffic in each direction often with planted medians.

- § Minimize stops and turns, and eliminate on-street parking.
- § Parking and service access curb cuts are discouraged.
- § Keep parking areas and buildings away from the road edge.

**If base-level criteria is unavailable, the following dimensions may be used:**

Travel Lane (a): 12' Median (b): 12' Curb and Gutter (c): 2' Sidewalk / Landscape (d): 12' Setback (f): 30' or per ATFP requirements.

UFC 3-201-01, UFC 3-250-01

**B02.1.2. Collector Streets**

Applicable  N/A Select number of graphics / images (large: 800 px x 440 px) to insert 1

Image Tool 800 x 440

Applicable  N/A Select number of graphics / images (small: 250 px x 188 px) to insert 1

Image Tool 250 x 188

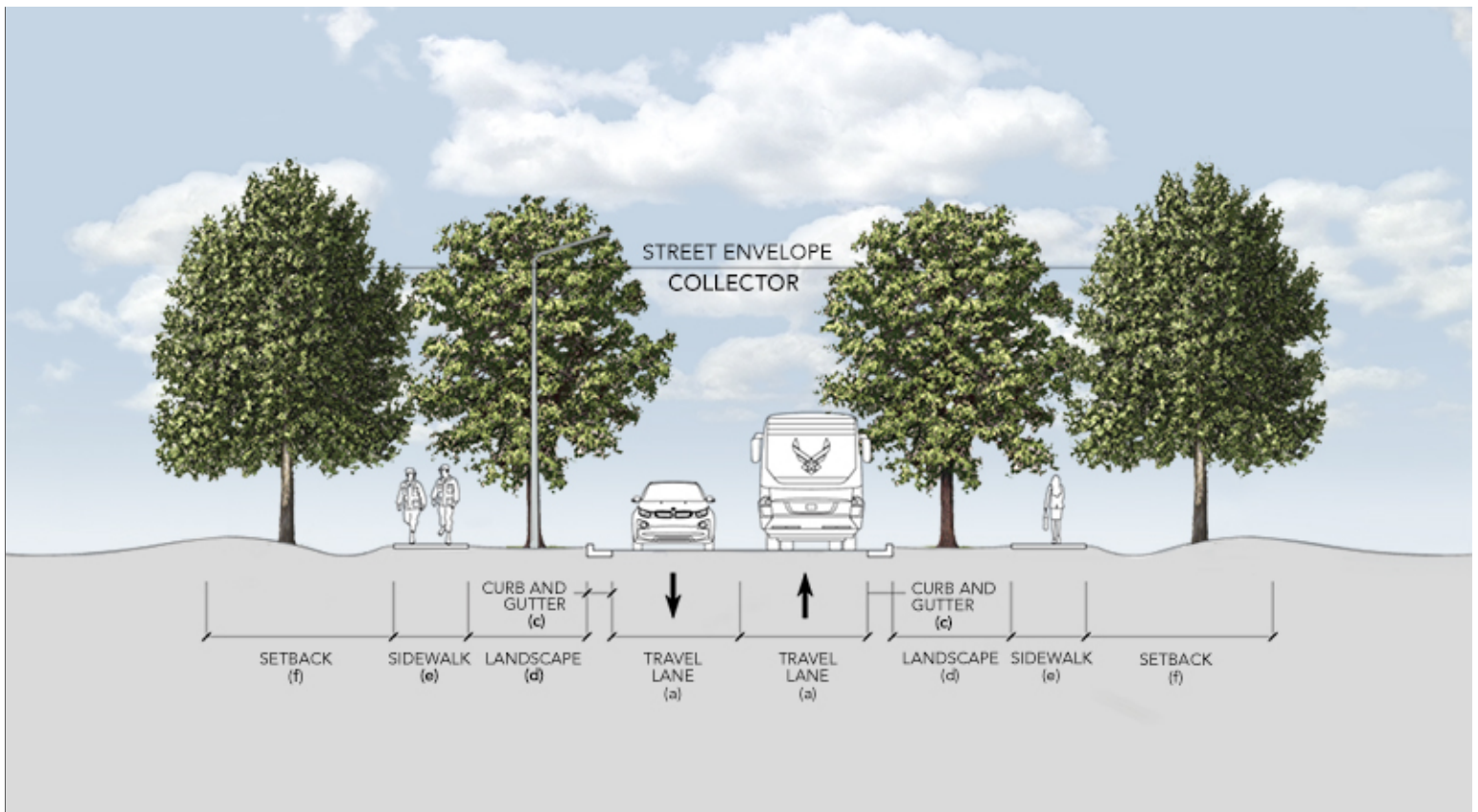

Travel Lane (a): 12' Median (b): N/A Curb and Gutter (c): 2' Landscape (d): 10' Sidewalk (e): 6' Setback (f): Min. 35' or per ATFP



Typical Collector Street

Secondary roadways are feeder streets from access roads to primary roads.

- § On-street parking is discouraged.
- § Keep off-street parking areas away from the road edge.
- § Minimize the number of curb cuts from driveways and area entrances.

**If base-level criteria is unavailable, the following dimensions may be used:**

Travel Lane (a): 12' Median (b): N/A Curb and Gutter (c): 2' Landscape (d): 10' Sidewalk (e): 6' Setback (f): 15' or per ATRP requirements

UFC 3-201-01, UFC 3-250-01



### B02.1.3. Local Streets

Applicable  N/A Select number of graphics / images (large: 800 px x 440 px) to insert 1

Image Tool 800 x 440

Applicable  N/A Select number of graphics / images (small: 250 px x 188 px) to insert 1

Image Tool 250 x 188

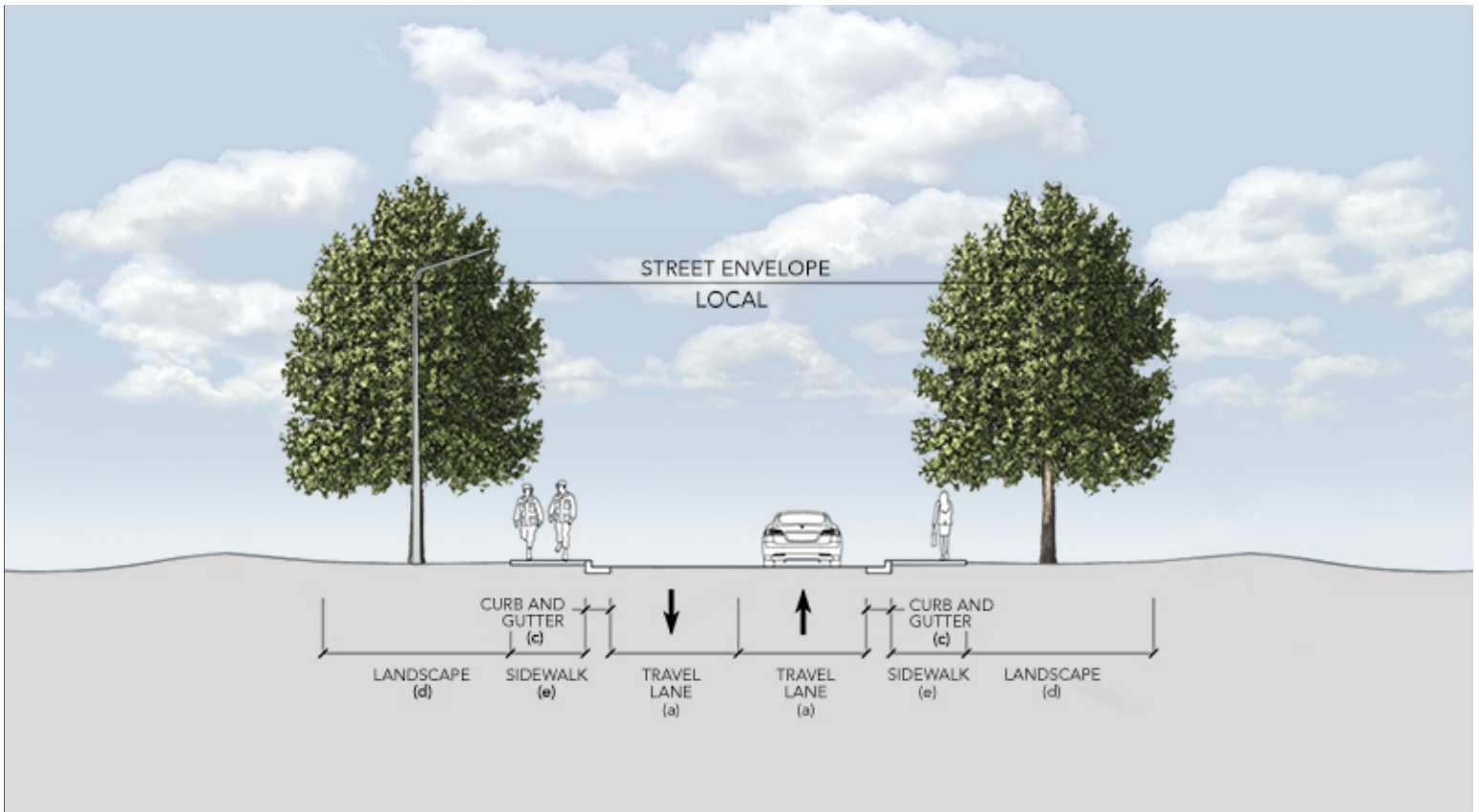

Travel Lane (a): 11' Median (b): N/A Curb and Gutter (c): 1.5' Landscape (d): 15' Sidewalk (e): 6'



Local Side Street

Tertiary roadways are the narrowest and slowest public streets and provide access to individual sites or parking areas.

- § On-street parking and curb-cuts for driveways, parking lot entrances, and services drive entrances are allowed.
- § Maintain capability for large vehicles such as fire trucks and moving vans.

**If base-level criteria is unavailable, the following dimensions may be used:**

Travel Lane (a): 11' Median (b): N/A Curb and Gutter (c): 1.5' Landscape (d): 15' Sidewalk (e): 6' Setback (f): 15' or per ATFP requirements

### **B02.1.4. Special Routes**

Applicable  N/A Large graphics do not apply

Applicable  N/A Small graphics do not apply

1. Develop all special routes consistently with those adjacent to Group 1 facilities.
2. Service drives provide access for service vehicles to certain parts of a building or site.
3. Combine service drives for several facilities where possible.
4. Sidewalks can double as service drives; size and design accordingly.
5. Maintain a setback between the building and service drive.
6. Minimize the visual impact of service drives through correct placement of drives and landscape screening.

### **B02.2. Hierarchy of Intersections**

Applicable  N/A Large graphics do not apply

Applicable  N/A Small graphics do not apply

1. Provide a hierarchy of intersections to include arterial, arterial-collector, collector, collector-local and local following UFC 3-201-01 and its industry references.
2. Passive systems such as traffic circles are preferred to active systems such as signalized intersections. Aggressively pursue passive systems to lower maintenance requirements and reduce energy use.
3. Use a level of visual quality for an intersection equal to the quality found in the related streetscape, which corresponds to the adjacent Facility Group number.

#### **B02.2.1. Arterials**

Applicable  N/A Large graphics do not apply

Applicable  N/A Small graphics do not apply

UFC 3-201-01, UFC 3-250-01

#### **B02.2.2. Arterial/Collector**

Applicable  N/A Large graphics do not apply

Applicable  N/A Small graphics do not apply

UFC 3-201-01, UFC 3-250-01



### **B02.2.3. Collectors**

Applicable  N/A Large graphics do not apply

Applicable  N/A Small graphics do not apply

UFC 3-201-01, UFC 3-250-01

### **B02.2.4. Special Intersections**

Applicable  N/A Large graphics do not apply

Applicable  N/A Small graphics do not apply

1. Develop all special intersections consistently with those adjacent to Group 1 facilities.

### **B02.2.5. Street Frontage Requirements**

Applicable  N/A Large graphics do not apply

Applicable  N/A Small graphics do not apply

1. Consistently maintain open space buffers following B03.2.3. Preserves.
2. Refer to C06.1.7. Streetscape Landscaping for planting and screen wall requirements along street frontage.

### **B02.2.6. Sight Lines**

Applicable  N/A Large graphics do not apply

Applicable  N/A Small graphics do not apply

1. Provide adequate sight lines for an effective and safe traffic operation per American Association of State Highway and Transportation Officials (AASHTO) standards and local municipality guidelines.

### **B02.3. Street Elements**

Applicable  N/A Large graphics do not apply

Applicable  N/A Small graphics do not apply

1. Emulate the streetscape area's pre-development hydrology using passive and active design features to help sustain the adjacent regionally appropriate landscape. Coordinate with the base Stormwater Management Plan.
2. Employ systems, materials and techniques to maximize streetscape sustainability. Consider pervious paving and reflectivity of surfaces appropriate for the local climate.
3. Install at-grade curbing and/or raised-profile curb and gutter as applicable to direct stormwater to bioswales and rain gardens as source water for vegetation. Do not paint concrete curbing.

4. Provide all on-site utility service lines and equipment below grade when adjacent to Facility Group 1. In routes along Group 2, 3 and 4, when mounting elements such as utility cabinets, communications equipment and water valves above grade is unavoidable, paint these consistently and provide visual screening following Installation Facilities Standards (IFS).
5. Provide traffic control devices including access control point/entry control facility signs, speed limit signs and street name signs following the current edition of the Manual on Uniform Traffic Control Devices (MUTCD) per UFC 3-120-01.
6. Follow UFC 3-120-01 for directional and wayfinding signs and address both vehicular and pedestrian traffic.
7. Reduce energy consumption and reduce maintenance requirements by providing street lighting only when functionally required to ensure safety and to address antiterrorism following UFC 4-010-01. Ensure the quality and quantities of lighting and fixtures are appropriate for the adjacent Facility Group number.

### **B02.3.1. Paving**

Applicable  N/A Large graphics do not apply

Applicable  N/A Small graphics do not apply

1. Use asphalt paving for all primary, secondary, and access roadways.
2. Use concrete paving in loading areas, dumpster enclosures, and sites used by heavy vehicles.
3. Gravel surfacing may be used on patrol roads and outlying sites only.
4. Incorporate a concrete apron where gravel roads meet paved roads.
5. All patching shall match adjacent materials.

### **B02.3.2. Curb and Gutter**

Applicable  N/A Large graphics do not apply

Applicable  N/A Small graphics do not apply

1. Comply with base CE standards for all 6-inch integrated concrete curb and gutter for all roadways in developed areas.
2. Patrol roads and service drives in outlying areas may not require curb and gutter, with ACRB approval.
3. Wheel stops in lieu of curbs are not allowed.
4. Do not paint concrete curbs.

### **B02.3.3. Utility Service Elements**

Applicable  N/A Large graphics do not apply

Applicable  N/A Small graphics do not apply

1. Provide all utility service lines below grade; when mounting elements (such as utility cabinets, communications equipment and water valves) above grade is unavoidable, paint these consistently and provide visual screening following Site Development, Landscaping.
2. Do not cut pavements to install utilities. Avoid free standing utility structures, and use underground vaults for equipment where possible.
3. Locate fire hydrants at least 5 feet away from other structures. Maintain a 30-inch clear area. Fire Hydrants shall be painted based on flow rates.
4. Locate pad-mounted equipment in less visible areas and screen with landscaping or screen walls.

#### **B02.3.4. Traffic Signs**

Applicable  N/A Large graphics do not apply

Applicable  N/A Small graphics do not apply

1. Refer to Exterior Signs, Colors and Types for Traffic Control Devices, which includes signs.

#### **B02.3.5. Street Lighting**

Applicable  N/A Large graphics do not apply

Applicable  N/A Small graphics do not apply

1. Refer to the Lighting section for appropriate applications along streets.

#### **B02.3.6. Other**

Applicable  N/A Large graphics do not apply

Applicable  N/A Small graphics do not apply

Crosswalks and Ramps:

1. Ensure that all paths lead to the safest crossing point possible, and cross roadways at 90-degree angles.
2. Incorporate ADA accessible curb ramps and crosswalk markings into all crosswalks.
3. Crosswalks should be designated with striping.
4. Construct all concrete curb ramps with a waffle stamp pattern and flared curb ramps.
5. Provide for adequate drainage away from the ramp or by drainage grates.

UFC 3-201-01, UFC 3-250-01

### **B03. OPEN SPACE / PUBLIC SPACE**

Comply with Air Force Corporate Standards for Installation Elements:

<http://afcs.wbdg.org/installation-elements/index.html>

### B03.1. Plazas, Monuments and Static Displays

Applicable  N/A Large graphics do not apply

Applicable  N/A Select number of graphics / images (small: 250 px x 188 px) to insert 3

Image Tool 250 x 188



In Memoriam Monument



Cold War Memorial



Flagpole Monument

1. Natural features and culturally or historically significant features or events may be recognized and acknowledged with physical elements such as plazas, monuments and static displays. However, limit these elements on the base to ensure judicious use of resources and to reduce ongoing maintenance requirements.
2. Design highly durable plazas, monuments and static displays with a level of quality comparable to Facility Group 1.
3. Link plazas, monuments and static displays to the pedestrian circulation system. Install landscaping, site furnishings and lighting appropriate for the application and local climate following Installation Facilities Standards (IFS).
4. Select systems, products and materials for paving, walls, and structures following IFS.

#### B03.1.1. Paved Plazas

Applicable  N/A Large graphics do not apply

Applicable  N/A Small graphics do not apply

1. Mitigate heat island by providing high-albedo, shaded plazas. Pervious pavers shall be used on all plazas and courtyards in Facility Groups 1 and 2 not subject to severe freeze-thaw cycles. The designer shall incorporate appropriate expansion and construction joints.
2. Use standard brick pavers or colored concrete as a unifying theme for plazas and courtyard paving. Use manufacturer standard patterns for concrete pavers.
3. Concrete may be stamped to accent the design.

### B03.1.2. Sculptures, Markers and Statuary

Applicable  N/A Large graphics do not apply

Applicable  N/A Small graphics do not apply

1. Relate new sculpture, markers and statuary to the base's architectural design theme. Generally limit these elements to frequently used locations adjacent to Facility Group 1 and highly traveled community pedestrian spaces.
2. Consider entry gates as possible sites for new displays.
3. All proposed memorials shall follow AFI 36-3108 and be limited to highly deserving individuals or groups as deemed appropriate by the installation leadership. Living memorials (tree plantings / etc.) are discouraged due to added maintenance requirements.
4. When sculpture requires a base, match the materials and / or color palette of adjacent buildings.
5. Use direct or indirect lighting to accentuate features or enhance an intended effect.
6. Ensure that all sculpture, markers and statuary are honorable and inspiring, provide a sense of place, positively contribute to the base's visual quality, and encourage pride for the community and the US Air Force.

### B03.1.3. Static Display of Aircraft

Applicable  N/A Large graphics do not apply

Applicable  N/A Select number of graphics / images (small: 250 px x 188 px) to insert 3

Image Tool 250 x 188



C-47D Skytrain



Commemorative Plaque



Various Aircraft

1. Follow IFS base-wide standards for all elements of the display area with specific attention to traffic sight lines, pedestrian circulation, site furnishings, signs, and lighting. Address requirements for the Facility District as well.
2. Generally locate concrete base/foundation structures for static displays below grade.
3. At static displays where pedestrian paths are provided, a minimum of one trash receptacle and one bench shall be provided. Receptacle and bench design must conform to IFS requirements.



## B03.2. Grounds and Perimeters

Applicable  N/A Large graphics do not apply

Applicable  N/A Select number of graphics / images (small: 250 px x 188 px) to insert 3

Image Tool 250 x 188



Open Green Space



Park and Recreational Areas



Provide areas of rest

1. Provide formal spaces for parade and review functions, recreational areas and parks following the base's Installation Development Plan (IDP) and Installation Facilities Standards (IFS). Refer to the Site Furnishings topic for additional information.
2. Maintain preservation areas following the IDP and IFS.
3. Comply with UFC 4-010-01 DoD Minimum Antiterrorism Standards for Buildings and UFC 4-022-03 Security Fences and Gates for all elements associated with the base's gates and perimeter fence.
4. Identify and describe base-wide utility corridors in the IDP.
5. Base-wide utility infrastructure shall be inconspicuous. Bury all utility service lines below grade.
6. Follow the requirements of this IFS regarding all utility structures and service lines located above grade that visually impact the installation.
7. Where screening of utility equipment and structures is provided, allow adequate and proper clearance for safety and maintenance.
8. Reduce visual clutter and visual impact of the following items through a combination of careful placement, screen walls, landscaping and painting:
  - Electrical switch-stations.
  - Sewage lift stations.
  - Water well pumps, storage tanks and/or related structures.
  - Gas piping, meters and similar incidental items.
  - Above ground fuel storage tanks.
  - Any ground-mounted freestanding utility item exposed to view.
9. Larger structures such as electrical switch-stations, sewage lift stations, fuel storage tanks and mechanical/electrical equipment shall be screened from view, using materials, forms, and colors in the screen walls which match those respective design elements present at adjacent buildings.
10. Paint above-ground equipment and associated components such as electrical piping or exposed plumbing lines dark bronze.
11. Maintain currently buried utility service lines as a visual asset.



12. Bury the following exposed above-grade items in future projects when economically feasible:

- Electrical power grid and service lines.
- Telephone lines.
- Cable TV lines.
- Communications lines.
- Exterior lighting service lines.
- Any similar system of above-ground lines serving the base.

13. Consolidate and enclose service utility lines in underground utility corridors when feasible. Create routes along the inside edge of parking lot islands.

### B03.2.1. Parade Grounds

Applicable  N/A Large graphics do not apply

Applicable  N/A Small graphics do not apply

1. Follow UFC 3-201-02, Appendix B for the planning and design process and criteria for parade grounds.
2. Establish and maintain parade grounds only where there is a confirmed need and provide landscape materials appropriate for the locale following IFS.
3. Bleachers may be installed only when there is a documented requirement at parade grounds. Nonferrous metals that do not require painting or going maintenance are preferred. The Base Civil Engineer shall determine quantities, sizes, and products on a case basis.

### B03.2.2. Parks

Applicable  N/A Large graphics do not apply

Applicable  N/A Select number of graphics / images (small: 250 px x 188 px) to insert 3

Image Tool 250 x 188



Shaded Areas for Gathering



Unobstructed Pedestrian Pathways



Decorative Paving

1. Bleachers may be installed only when there is a documented requirement at parks and fields for recreational events. Follow guidance under Parade Grounds.
2. Picnic pavilions may be provided in parks where there is a documented need. Locate pavilions centrally among facilities being served to create multipurpose use.
3. Construct new pavilions with brick columns and low-sloped gable, standing seam dark brown metal roofs at high-visibility locations.

4. Use manufactured pavilions in low-visibility locations with ACRB approval only.  
Wood gazebos are not allowed.

### **B03.2.3. Preserves**

Applicable  N/A Large graphics do not apply

Applicable  N/A Small graphics do not apply

1. Preserve areas adjacent to runways, taxiways, aprons, golf course roughs, storage areas, antenna facilities, and ammunition storage areas, as open space.
2. Provide minimal maintenance with mowing as needed for controlling bird behavior for airfield safety, or eliminating fire hazards.

### **B03.2.4. Perimeter Fence**

Applicable  N/A Large graphics do not apply

Applicable  N/A Small graphics do not apply

1. Design, install and maintain the base's perimeter fence following UFC 4-022-03.
2. Perimeter fencing shall respond to the site context and use combinations of vinyl-covered chain link, decorative metal, or brick per ACRB direction.
3. Stringently comply with AT / FP requirements following UFC 04-010-01 for all spaces adjacent to the base's perimeter fence and all gates.
4. Fencing, gates and other elements that are associated with the main gates shall be a level of quality equivalent to Facility Group 1. Wrought iron fencing may be used for high visibility sites.
5. Maintain a positive visual quality along the traffic corridor on both sides of the main gates. Specifically address pedestrian access, circulation and common areas.
6. Wood or white vinyl is allowed only in the Facility Group 4.

## C. SITE DEVELOPMENT

Comply with Air Force Corporate Standards for Site Development:  
<http://afcs.wbdg.org/site-development/index.html>

### C01. SITE DESIGN

Comply with Air Force Corporate Standards for Site Development:  
<http://afcs.wbdg.org/site-development/index.html>

Comply with AF Corporate Standards for Site Design / NEPA:  
<http://afcs.wbdg.org/site-development/site-design-nepa/index.html>

#### C01.1. Site Design Considerations

Applicable  N/A Large graphics do not apply

Applicable  N/A Small graphics do not apply

1. Collect documentation to validate approvals and completion of the NEPA process.
2. Ensure site design compliance with the Installation Development Plan (IDP) and its component plans and Installation Facilities Standards (IFS).
3. Develop a strong relationship between buildings and exterior spaces. Articulate building facades to create areas of shade and shadow.
4. Promote integrated design with on-site solutions such as engineered small-scale hydrologic controls versus base-wide infrastructure; consider open space, natural features, bioswales, building roofs, streets, and paved surfaces.
5. Limit the impact of development on land and water resources. All site elements and infrastructure shall reinforce an image of sustainability, with reduced energy demand, renewable-energy usage, and water conservation.
6. Consider energy conservation during site design for the following categories: building and site lighting, auxiliary systems and equipment (refrigerators, elevators, etc.), building envelope, electric power and distribution, HVAC systems and equipment, service hot water, energy management (metering, EMCS).
7. Coordinate on-site renewable-energy systems and components to minimize area requirements and maximize efficiencies. Appropriately buffer and screen these and other mechanical systems and equipment.
8. New building projects should preserve open space and protect natural habitat.
9. Conform to existing topography to the greatest extent possible and use slopes to increase site and building efficiencies. Design sites to minimize irrigation and impacts to stormwater runoff.
10. Carefully study new project sites to identify the character of adjacent buildings, streets, landscaping, and site design elements. Reinforce the existing character in new site design.
11. Consider relationships to adjacent facilities and district / centralized heating and cooling infrastructure and cost effectively connect building systems to harvest heat, grey water or other beneficial byproducts.
12. Minimize existing and planned obstructions from landscaping, structures, topography, and adjacent developments to preserve solar access and natural ventilation.
13. Purposefully integrate service access, receiving and storage areas to eliminate the need for visual screening. Combine functions whenever possible to avoid a proliferation of small independent structures.
14. Appropriately connect to the base network of streets, sidewalks and trails using drive aisles, parking areas, walkways, paths, and bicycle routes addressing both vehicles and pedestrians.

15. Applicable coordinate heat island mitigation in paving and roof designs when implementing an integrated approach to stormwater management.

16. Consider the location of "Designated Tobacco Areas."

### C01.2. Building Orientation

Applicable  N/A Select number of graphics / images (large: 800 px x 440 px) to insert 1

Image Tool 800 x 440

Applicable  N/A Select number of graphics / images (small: 250 px x 188 px) to insert 6

Image Tool 250 x 188

#### DRIVING FACTORS

- |  |  |  |   |
|--|--|--|---|
| • Optimal solar orientation of the building.   | • Maximize the daylight & desirable views.       | • Meet the required AT/FP standoff distance          | • Create a unified campus                       |
| • Main entrance from Pepperrell street.        | • Saving existing vegetation and trees           | • Separation between staff/public/materials entrance | • Outdoor healing environment                   |
| • Addressing the orientation of the future ACC | • Visibility of the new facility from main roads | • Required parking spaces for public and staff       | • Implementation of landscape zones A, B, C & D |

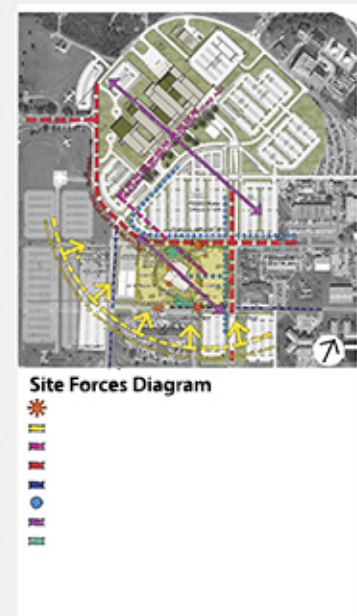
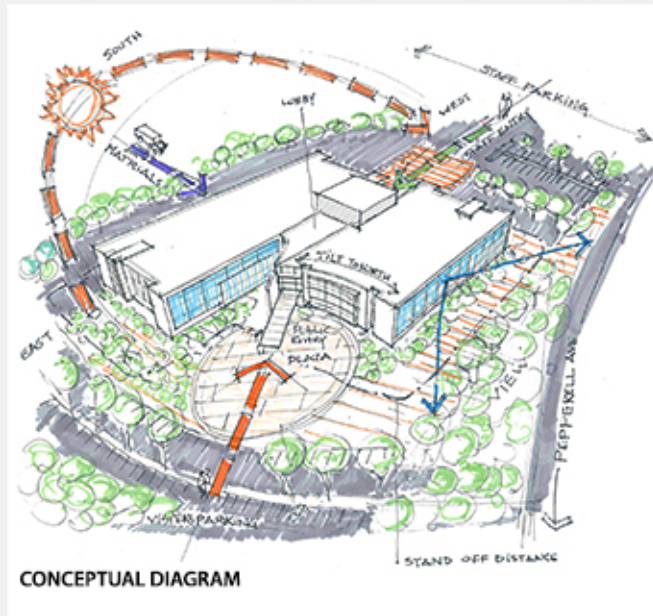

Conceptual Site Analysis and Site Design Diagram

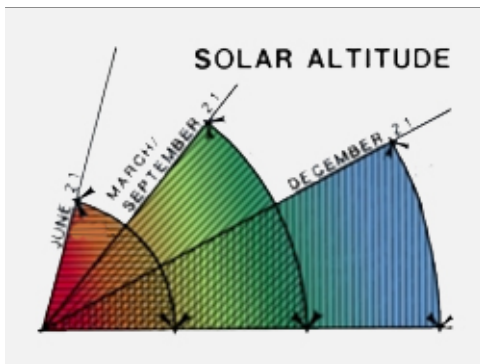

Local Solar Data

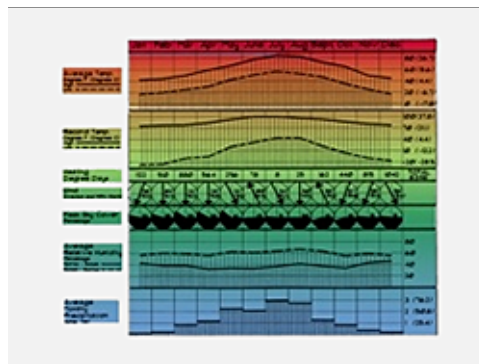

Local Climate Data

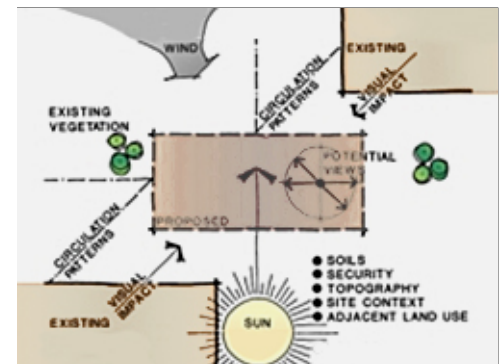

Site Data

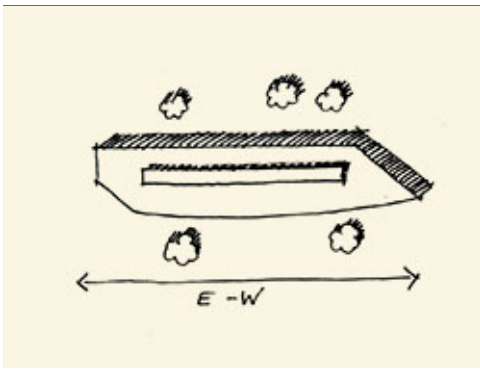

East-West Axis

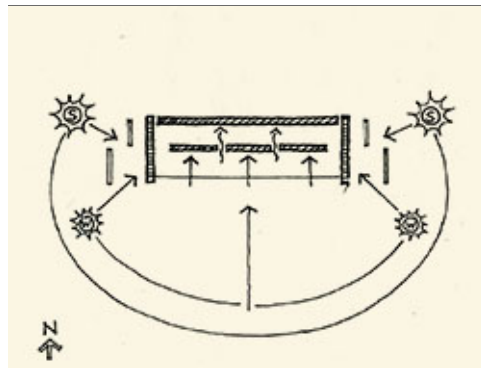

Optimum Solar Control

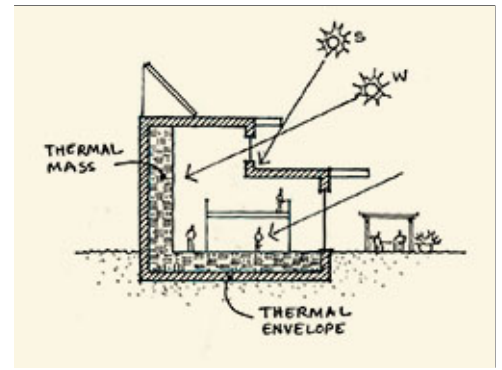

Optimized Shading

1. Ensure the site will accommodate optimum requirements for building orientation, which is with the long axis parallel to the east/west direction for rectilinear CONUS buildings.
2. Meet Installation Facilities Standards (IFS) requirements for the locations of the building's passive and renewable-energy systems and exterior shading systems as applicable.
3. Locate the building(s) and permitted ancillary structures to promote solar gain, solar shading, natural ventilation, rainwater harvesting, wind buffering and other beneficial passive systems. Consider natural ventilation during the design of HVAC systems.
4. Consider relationships to adjacent sites and their facilities and infrastructure, and cost effectively integrate building systems to harvest heat, grey water or other beneficial byproducts.
5. Consider the "public side" of the building, its views and the location of the main entrance.

## C02. UTILITIES

Comply with AF Corporate Standards for Site Development:

<http://afcs.wbdg.org/site-development/index.html>

Comply with AF Corporate Standards for Utilities:

<http://afcs.wbdg.org/site-development/utilities/index.html>



## C02.1. Utility Components

Applicable  N/A Large graphics do not apply

Applicable  N/A Select number of graphics / images (small: 250 px x 188 px) to insert 3

Image Tool 250 x 188



Vegetation helps break up hardscape



Utility components hidden by vegetation



Transformer hidden by landscape screening

1. Provide all on-site utility service lines below grade; when mounting elements (such as utility cabinets, communications equipment and water valves) above grade is unavoidable, paint these consistently with their hosting wall colors and provide visual screening following Installation Facilities Standards (IFS). Exterior surface-mounted utility con lines, or equipment are NOT allowed (except meters and control devices).
2. Provide installation of utility infrastructure to support near term and future electric vehicle charging stations.
3. Define all service entry points into the building and route distribution below grade into an interior space within the facility; exposed conduits, cables and wires on exterior walls are not permitted for Facility Group 1.
4. Include consideration of appropriate placement of meters in support of Automated Revenue Management Services (ARMS). Locate mechanical equipment on the least public side of the building.
5. Limit exterior mechanical distribution systems such as exterior steam, chilled water, and hot water distribution to Group 3 facilities; when required for Group 1 and 2 facilities integrate with the architecture and provide visual screens following IFS.
6. Direct roof drainage to underground collection when feasible or provide splash blocks / paved channels to intercept roof drainage at grade.
7. In remote locations, paint freestandpipes and above-ground utility system components Spanish Moss.
8. Fire hydrants shall be painted in accordance with UFC 3-600-01.
9. Collocate coaxial and telephone extecomponents and entry points. Align all communication components with one another on the horizontal and vertical plane.

## C03. PARKING AREAS

Comply with AF Corporate Standards for Site Development:

<http://afcs.wbdg.org/site-development/index.html>

Comply with AF Corporate Standards for Parking Areas:

<http://afcs.wbdg.org/site-development/parking-areas/index.html>



## C03.1. Configurations and Design

Applicable  N/A Large graphics do not apply

Applicable  N/A Select number of graphics / images (small: 250 px x 188 px) to insert 3

Image Tool 250 x 188

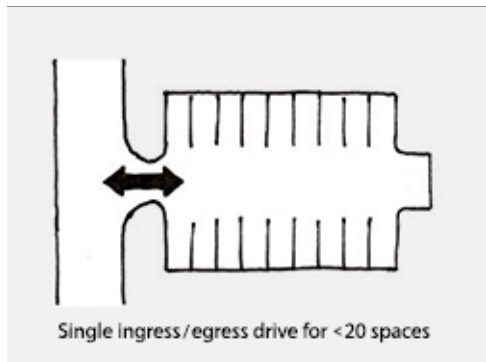

Small Lot Configuration

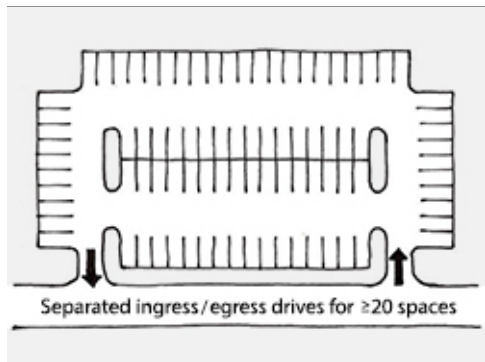

Large Lot Configuration

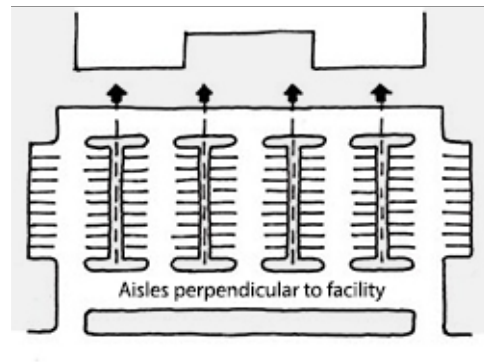

Facility Group 1 Configuration

1. Evaluate adjacent sites and cost-effectively consolidate parking areas to maximize efficient use; ensure that all areas meet accessibility guidelines. Parking layout must address accessibility, maintenance, snow removal, and safety issues.
2. Generally envision on-site parking as a series of small connected singular areas selectively placed around the facility served, rather than a single large area; buffer parking areas from the facility main entrance with a transition space and provide drop-offs to decrease close-in parking. Comply with IFS standards while meeting AFTP requirements. Reduce large parking areas with landislands and planting strips.
3. Integrate at-grade and raised-profile curbing, permeable paved areas, and parking islands with the stormwater system and direct stormwater to bio-swales and rain gardens as source water for regionally appropriate native vegetation.
4. Define pedestrian access with approved hardscape and provide shading along the primary path from the parking area to the main entrance of the building.
5. Coordinate suitable landscape or barriers integrated with walls and fences to ensure adequate force protection.
6. Accessible parking spaces shall be marked according to UFC 3-120-01 and its references in ABAAS and the MUTCD. Use the 90-degree parking configuration when possible.
7. Consider locations and requirements of near term and future electric vehicle charging stations.
8. Designate preferred parking spaces for electric vehicles and carpools near the main entrance.
9. Reserved parking is discouraged except for Facility Group 1. Reserved parking shall be designated by rank or title with curb-mounted signs.
10. On-street parking is discouraged except in multi-use areas. When used, provide approved on-street parking configurations following UFC 3-201-01.
11. Access and service drives should accommodate the largest vehicle serving the facility.

### C03.1.1. Paving and Striping

Applicable  N/A Large graphics do not apply

Applicable  N/A Small graphics do not apply

**Facility Group 1** paving materials shall be as follows.

Primary: Asphaltic concrete

Secondary: Concrete

Accent: N/A

**Facility Group 2** paving materials shall be as follows.

Primary: Asphaltic Concrete

Secondary: N/A

Accent: N/A

**Facility Group 3** paving materials shall be as follows.

Primary: Concrete where operationally required

Secondary: Asphaltic Concrete

Accent: N/A

**Facility Group 4** paving materials shall be as follows.

Primary: Concrete

Secondary: N/A

Accent: N/A

1. All new parking lots in Groups 1 and 2 shall be constructed of asphalt paving. Concrete paving shall be used in Groups 3, and where required for heavy vehicles, motorcycle parking, and where fuel spills may occur
2. Cost-effectively provide light-colored concrete to reduce heat island effect; otherwise install asphaltic concrete paving. Dirt, gravel, and grass lots are not allowed.
3. Use consistent striping, angles and stall sizes in all parking areas.
4. All parking shall be marked with white stripes of paint or applied vinyl coatings. Red or yellow markings shall only be used for safety purposes and must be kept to a minimum. All lines shall be four inches (4") wide.

### C03.1.2. Curbing

Applicable  N/A Large graphics do not apply

Applicable  N/A Select number of graphics / images (small: 250 px x 188 px) to insert 2

Image Tool 250 x 188

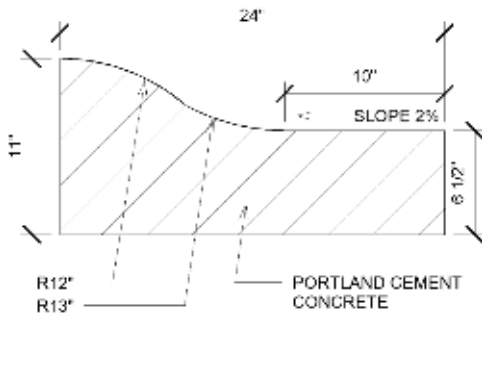

"Rolled" Curb

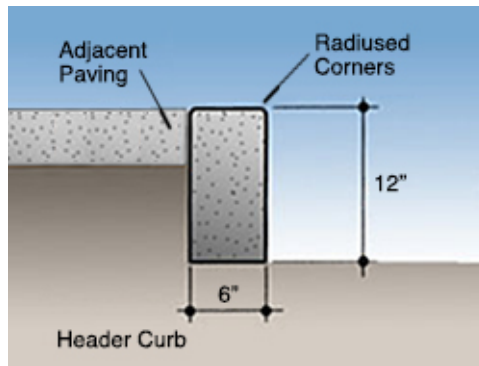

Conventional Barrier Curb

**Facility Group 1** curbing / edging materials shall be as follows.

Primary: Concrete, rolled curb

Secondary: N/A

Accent: N/A

**Facility Group 3** curbing / edging materials shall be as follows.

Primary: Concrete, rolled curb

Secondary: N/A

Accent: N/A

**Facility Group 2** curbing / edging materials shall be as follows.

Primary: Concrete, rolled curb

Secondary: N/A

Accent: N/A

**Facility Group 4** curbing / edging materials shall be as follows.

Primary: Concrete, rolled curb

Secondary: N/A

Accent: N/A

Basewide curbing shall consist of concrete rolled curbing.

1. Define all parking lots with either raised profile or at-grade curbing to promote drainage and protect paving edges. All raised curbs shall be concrete, and shall be the rolled (mountable) type. Do not paint concrete curbs.
2. Integrate curbing to direct stormwater to bioswales and rain gardens as source water for regionally appropriate native vegetation.
3. Wheel stops are not permitted except at locations where car bumpers could contact adjacent items such as poles, signs or pedestrians.
4. Asphalt curbs, wood timbers, and precast wheel stops are prohibited.

### C03.1.3. Internal Islands and Medians

Applicable  N/A Large graphics do not apply

Applicable  N/A Select number of graphics / images (small: 250 px x 188 px) to insert 1

Image Tool 250 x 188



Median serves as a visual break

1. Install landscape islands and medians as visual breaks, to reduce heat island effects and to accommodate bioswales and rain gardens with consideration for snow removal. Coordinate suitable landscape or barriers integrated with walls and fences to ensure adequate force protection.
2. Provide planting medians for every four rows of vehicles and paver islands for every 20 stalls. Coordinate with snow removal operations.

3. When lighting is necessary, contain fixture bases within medians or internal landscape islands. Coordinate layout for light poles with the islands and minimize their number to provide the required illumination.
4. Provide designated areas for pedestrian cross traffic.

### **C03.2. Parking Structures**

Applicable  N/A Large graphics do not apply

Applicable  N/A Small graphics do not apply

1. Parking structures are not used at Fairchild AFB due to both, the availability of land and the high costs associated with constructing structured parking.

### **C03.3. Connectivity**

Applicable  N/A Large graphics do not apply

Applicable  N/A Small graphics do not apply

1. Refer to the Installation Development Plan (IDP) for locations of transit stops and pedestrian and cycling networks; provide appropriately sized sidewalks and bike paths to connect facilities and users to these networks.
2. Provide amenities such as rain and shade shelters, trees, and benches to encourage and facilitate use of public transportation.
3. Evaluate the IDP for the current and planned network of roads and optimally develop vehicular access to and from the site.

## **C04. STORMWATER MANAGEMENT**

Comply with AF Corporate Standards for Site Development:

<http://afcs.wbdg.org/site-development/index.html>

Comply with AF Corporate Standards for Stormwater Management:

<http://afcs.wbdg.org/site-development/stormwater-management/index.html>

### **C04.1. Stormwater Requirements**

Applicable  N/A Large graphics do not apply

Applicable  N/A Small graphics do not apply

1. Design all stormwater systems including retention ponds, detention areas, channels, etc. as on-site amenities that are consistent with natural systems and drainage patterns, that help sustain the base landscape with beneficial functionality and that provide aesthetic appeal; coordinate with the base Stormwater Management Plan.
2. Incorporate bioswales into the design of all roadway, parking and facility roof systems to enhance water quality and support the overall stormwater system.
3. Permeable paving may be used in areas that are not subjected to severe freeze-thaw cycles, and will be approved on a case basis.
4. Give consideration to rainwater harvesting and storage that is attached to the building's roof drain systems to support grey water irrigation; consider freeze protection for winter months.

5. When underground drainage systems are required establish a maintenance program to include removal of sediments and debris; inspect joints seasonally for alignment to prevent leakage and the development of voids and surface failures.

6. Cost-effectively integrate stormwater systems with ATFP measures.

## C05. SIDEWALKS, BIKEWAYS AND TRAILS

Comply with AF Corporate Standards for Site Development:

<http://afcs.wbdg.org/site-development/index.html>

Comply with AF Corporate Standards for Sidewalks, Bikeways and Trails:

<http://afcs.wbdg.org/site-development/sidewalks-bikeways-trails/index.html>

### C05.1. Circulation and Paving

Applicable  N/A Large graphics do not apply

Applicable  N/A Select number of graphics / images (small: 250 px x 188 px) to insert 3

Image Tool 250 x 188



curvature provides interest

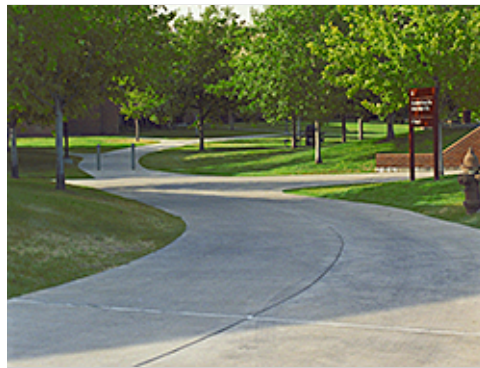

pathways should correspond to site



balance aesthetics with function

**Facility Group 1** sidewalks, plazas, and courtyards paving materials shall be as follows.

Primary: Concrete

Secondary: Concrete Edging

Accent: Colored Concrete

**Facility Group 2** sidewalks, plazas, and courtyards paving materials shall be as follows.

Primary: Concrete

Secondary: Concrete Edging

Accent: N/A

**Facility Group 3** sidewalks, plazas, and courtyards paving materials shall be as follows.

Primary: Concrete

Secondary: N/A

Accent: N/A

**Facility Group 4** sidewalks, plazas, and courtyards paving materials shall be as follows.

Primary: Concrete

Secondary: N/A

Accent: N/A

1. Maintain efficient geometry and accessibility to connect building entrances to adjacent parking areas and activity areas and to the base transportation system following ATFP. Efficiently use materials to optimize life-cycle costs and to minimize maintenance.



2. Generally conform horizontal layouts of sidewalks to the geometric configuration of adjacent buildings, streets, parking lots, waiting shelters, and other adjacent related site amenities. Occasional meanders and/or jogs may be included to capture views, to coordinate with landscaping or accommodate site constraints.
3. Walks in parking areas shall provide a direct path using "safe islands" and "peninsulas" to encourage safety. Walks parallel to streets shall follow streetscape guidelines. Clearly mark pedestrian crossings at vehicular routes.
4. Mitigate heat island by providing high-albedo, shaded sidewalks. Pervious pavers may be used on a case basis. The designer shall incorporate appropriate expansion and construction joints.
5. Only experienced contractors will install pervious pavements.
6. Consider an integrated approach that could include stormwater management (permeable surfaces) and complement the design of the storm drainage system when appropriate.
7. Pedestrian paths should be at least 5' in width to allow for comfortable side-by-side walking.
8. Sidewalks leading to a building main entrance and at the interior of parking lots shall be a minimum width of 6'. Walks greater than 10' wide may be used at high-density pedestrian areas where volumes of traffic justify added material.
9. Where cars park adjacent and head-in to the sidewalk and wheel stops are not used, such perimeter walks shall be increased to a minimum width of 8' to accommodate overhangs of the parked vehicles.
10. All sidewalks shall have positive drainage to prevent ponding of water or ice accumulation with slopes ranging from 2.1% to 4.2%. Walks with a slope greater than 4.2% shall be designed as ramps following accessibility guidelines. All walks shall have a minimum cross slope of 2.1%.
11. Maintain a minimum 3-foot wide landscaped parkway between curb and sidewalk.
12. Pavers shall conform to the following range of color: red or natural concrete.
13. Sidewalks shall use natural colored concrete with a broom finish and troweled edges.
14. Connect to the bicycle circulation system and provide bicycle parking with a suitable means for securing bicycles following IFS. Consider changing/shower facilities for use by cyclists. Emphasize pedestrian and bicycle circulation within Facility Group 4 areas and connect to community facilities.
15. Recreation trails:
  - Provide a minimum 6-foot paved width in a free form configuration that follows the contours or other natural features.
  - Separate the trail system from vehicutraffic by a minimum of 10 feet.
  - Take advantage of natural environments such as the natural wildlife area.
  - Incorporate activity generators, interpretive signs, and recreation opportunities.
  - Provide a 5-foot by 10-foot paved rest area approximately every mile. Include a bench and litter receptacle at each location.
  - Use asphaltic concrete for the trail system. In highly natural settings use compacted, crushed fines.
16. Refer to the Installation Development Plan for future trails, bicycle paths, and sidewalks.

### **C05.1.1. Ramps and Stairs**

Applicable  N/A Large graphics do not apply

Applicable  N/A Small graphics do not apply

1. Use ramps instead of stairs for sidewalks, bikeways and trails and at all buildings where possible. Where steps are unavoidable, follow UFC 1-200-01 and its references to the International Building Code.

### C05.1.2. Lighting

Applicable  N/A Large graphics do not apply

Applicable  N/A Small graphics do not apply

1. Provide lighting for all stairs and landings where traffic warrants.
2. Refer to the Lighting section for path lighting along sidewalks, bikeways and trails.

## C06. LANDSCAPE

Comply with AF Corporate Standards for Site Development:

<http://afcs.wbdg.org/site-development/index.html>

Comply with AF Corporate Standards for Landscape:

<http://afcs.wbdg.org/site-development/landscape/index.html>

### C06.1. Climate-based Materials

Applicable  N/A Select number of graphics / images (large: 800 px x 440 px) to insert 1

Image Tool 800 x 440

Applicable  N/A Select number of graphics / images (small: 250 px x 188 px) to insert 3

Image Tool 250 x 188



Evergreen shrubbery is paired with deciduous trees





evergreen shrubs



resilient concrete edging defines boundaries

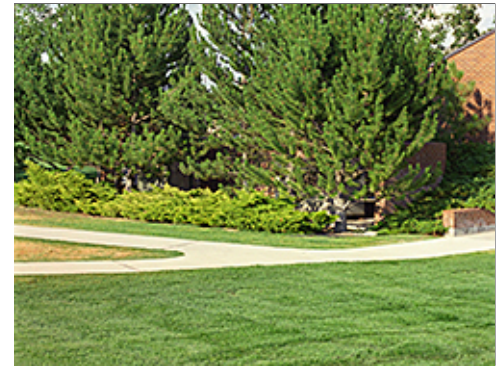

landscaped pedestrian walkways

1. Use only native, naturally occurring, drought tolerant indigenous plant species (including grasses) appropriate for the locale to promote energy efficiency and water conservation, preserve drainage patterns, inhibit erosion, improve air quality, lower maintenance, and add beauty.
2. Follow details and specifications of the American Standard for Nursery Stock, current edition.

### C06.1.1. Landscape Design Concept

Applicable  N/A Large graphics do not apply

Applicable  N/A Select number of graphics / images (small: 250 px x 188 px) to insert 2

Image Tool 250 x 188



Landscaped Boundary



Annual and evergreen shrubbery

1. Develop, maintain and implement a climate-based plant list with landscape features using a regionally appropriate palette of materials to promote energy efficiency, preserve drainage patterns, inhibit erosion, improve air quality, lower maintenance and add beauty. Follow UFC 3-201-02 Landscape Architecture.
2. Landscaping is required for all newly developed sites and facilities; preserve existing native landscape where possible and avoid overplanting.
3. Concentrate landscaping in Facility Group 1 and along major thoroughfares and integrate these landscaped areas into the base's stormwater management plan. Refer to the Streetscape Envelope Standards in this IFS.
4. All Facility Group 1 and 4 sites shall be landscaped at their entire perimeter; limit formal planting arrangements to formal spaces typically associated with Group 1. Landscape public spaces near the main entrances of Group 1 facilities. Use landscaping elements that compliment building architectural features and proportions. Highlight building entry and screen unattractive building features such as utility risers or service areas.
5. For Facility Group 4:

- Use mixed species and informal land to integrate new with existing housing areas and to improve the overall community setting.
- Add plantings for shade and privacy and develop foundation plantings.
- Use randomly spaced plantings and tree massing.
- Landscape the perimeter edges of recreational and common areas.
- All self-help landscape materials are to follow the ACRB's approved material list.

6. Facility Group 2 and 3 sites may have a native undisturbed landscape except at the main entrances of Group 2, which should be newly landscaped.
7. Facility plantings shall follow the Installation Facilities Standards (IFS) plant list, which is based on the specific microclimates created by the adjacent building: shadow areas, protected areas, zones adjacent to thermal mass, and availability of rainwater and/or grey water.
8. Provide open spaces as transitions between developed and native areas that promote quality of life and provide visual relief and allow walkable connections to the transportation system.
9. Return suitable areas to a natural state to minimize and, whenever possible, eliminate ground maintenance requirements; expand prairie areas where appropriate with native plants to eliminate mowing and maintenance requirements.
10. In tree clusters replace grass with naturalized shrub beds and leaf litter mulch to eliminate mowing requirements.
11. Use plantings in open spaces to reinforce the space as a visual asset. Design randomly spaced plant and tree massing to fill areas between facilities. Provide a soft transition from the horizontal ground plane to the plane of the building.
12. Consider landscape windbreaks when suitable for the local climate.
13. Integrate security requirements into the landscape design. Coordinate the heights of trees and shrubs and note restrictions for plantings following UFC 4-010-01.
14. Berms may be used as an integral part of the overall landscape strategy for screening, security and/or visual interest. Incorporate maintenance-free ground cover materials in areas of steep slope or areas that are difficult to maintain.

### C06.1.2. Xeriscape Design Principles

Applicable  N/A Large graphics do not apply

Applicable  N/A Small graphics do not apply

1. Apply xeriscape principles following UFC 3-201-02, Appendix B, and Air Force Corporate Facilities Standards.
2. Facility plantings are encouraged to use native plant species and to consider specific microclimates created by the adjacent building: shadow areas, protected areas, zones adjacent to thermal mass, and availability of rainwater and/or grey water.

### C06.1.3. Minimizing Water Requirements

Applicable  N/A Large graphics do not apply

Applicable  N/A Small graphics do not apply

1. Reasonably reduce demand on potable water while seeking opportunities to increase alternative water sources for irrigation. Reduce or eliminate the use of potable/domestic water for purposes of landscape architecture maintenance, consistent with existing legal or contractual obligations, and prohibit potable-water irrigation in new construction beyond establishment following current DoD and Air Force policy.



#### C06.1.4. Plant Material Selection

Applicable  N/A Select number of graphics / images (large: 800 px x 440 px) to insert 1

Image Tool 800 x 440

Applicable  N/A Small graphics do not apply



Landscape shrubbery aligns with climatic conditions

1. Use only native, naturally occurring plant materials including grasses or turf suited for the local climatic conditions in the landscape design; potable-water irrigation systems are discouraged beyond the establishment period.
2. New facilities are encouraged to use native plant species as indicated on the plant list available from the BCE.
3. Trees should be the focus of landscape plantings and, where possible, should be a mix of deciduous and evergreen species for variety; provide tree grates when appropriate and use tree guards on smaller trees.
4. Ground covers are only recommended when minimal maintenance is required.
5. Turf areas should be limited to those that can be sustained by natural rainfall or grey water (non-potable) irrigation systems; turf may be defined by at-grade concrete mow strips to lessen maintenance.
6. Analyze soils and provide organic amendments as needed to improve plant growth and conserve water.
7. All plant material shall have one-year warranty and is subject to approval by the Base Landscape Architect.



### **C06.1.5. Water Budgeting (Hydrozones)**

Applicable  N/A Large graphics do not apply

Applicable  N/A Small graphics do not apply

1. Comply with DoD and Air Force policy on potable-water irrigation systems.
2. Provide irrigation systems in new construction to establish plant materials following "Water for Landscaping" in UFC 1-200-02. Note the climate zone and annual rainfall for the locale.
3. Ensure that landscape areas to be irrigated are adequately separated from structures to prevent moisture on masonry walls and efflorescence. Efflorescence in masonry work is unacceptable, and all masonry materials shall be classified as low-efflorescence.
4. Use shredded softwood or rock mulch with landscaping fabric to increase moisture retention and control weed growth.
5. New buildings shall cost-effectively integrate a grey-water reclamation system following UFC 1-200-02, which provides source water for an automatic drip irrigation system; connect adaptive plantings adjacent to facilities to a grey-water irrigation system when available and discontinue the use of potable water for irrigation after the establishment period.
6. Provide irrigation design following UFC 3-201-02. Install drip irrigation products and components following UFGS Section 32 84 24 Irrigation Sprinkler Systems. Match the color of valve box lids to the adjacent ground treatment (i.e. green at turf & native seed areas, brown at wood mulch & rock areas).
7. Life cycle cost-effectively equip irrigation systems to sense soil moisture, rainfall and wind to minimize unnecessary watering; incorporate drip irrigation systems as the primary source.

### **C06.1.6. Base Entrance Landscaping**

Applicable  N/A Large graphics do not apply

Applicable  N/A Small graphics do not apply

1. At the main gate, reinforce a sense of arrival through a well-designed concentration of landscape elements consistent in visual quality with Facility Group 1.
2. Ensure landscaping has seasonal features with spring and fall color and a combination of evergreen and deciduous trees and shrubs for winter interest.
3. Integrate base signs and street and pedestrian lighting whenever feasible.

### C06.1.7. Streetscape Landscaping

Applicable  N/A Large graphics do not apply

Applicable  N/A Select number of graphics / images (small: 250 px x 188 px) to insert 2

Image Tool 250 x 188



Brick Planters



"Rolled Curbing"

1. Provide landscape designs with plant materials appropriately representing the level of quality of the adjacent Facility Group number. Refer to the Installation Elements section.
2. Plant street trees on the building side of sidewalks.
3. Primary roadways use same species, deciduous and coniferous street trees equally spaced to coordinate with light standards.
4. Secondary and access roadways use a more random spacing of mixed spein clusters and / or groupings at focal points.
5. Select a variety of regionally appropriate streetscape plantings and grading to create a visual interest.

### C06.1.8. Pedestrian Circulation Landscaping

Applicable  N/A Large graphics do not apply

Applicable  N/A Select number of graphics / images (small: 250 px x 188 px) to insert 2

Image Tool 250 x 188



Landscaping highlights walkways



Transitions are highlighted by landscaping

1. Define walkways with landscaping where appropriate.
2. Provide rest areas along the pedestrian circulation network with human-scaled deciduous shade trees. Supplement tree plantings with finely textured shrubs when appropriate for the climate.

3. Provide wind breaks where required.

### C06.1.9. Parking Lot Landscaping

Applicable  N/A Large graphics do not apply

Applicable  N/A Select number of graphics / images (small: 250 px x 188 px) to insert 2

Image Tool 250 x 188



Soften the edge of paved areas



Turf grass provides ground cover

1. Integrate appropriate landscaping elements such as shrubbery, and landscaped berms into parking areas to visually soften the appearance.
2. Avoid trees that drop sap, fruit, or seeds, and use long-lived species; keep trees trimmed, removing dead and dying trees or branches.
3. Fill in between trees with low shrubs, flowers, and ground covers. Allow areas for pedestrian cross circulation.
4. Provide planting in islands within parking lots for shade and appeal following IFS and the base stormwater management plan.
5. Use shrubs in groupings around the perimeter of parking areas to soften views from the street.
6. Avoid the use of hedges outlining parking areas.
7. Rain garden islands shall be landscaped to receive rainwater runoff from adjacent impervious parking areas to be absorbed into the ground/planting bed. Native plants and groundcovers are recommended within the rain garden areas, which can survive without supplemental irrigation once established.

### C06.1.10. Screen/Accent Landscaping

Applicable  N/A Large graphics do not apply

Applicable  N/A Small graphics do not apply

1. Provide complimentary accent landscaping at monuments and static displays.
2. At Facility Group 1, provide landscaping adjacent to all freestanding signs without distracting from the written communication.
3. Provide landscape screening of utility elements adjacent to Facility Group 1.

4. Providing landscaping as visual screening is preferred to the construction of walls and fences; berming and mounding may supplement landscape screening. Use a three-tier landscaped screen that combines ground covers, shrubs, and small trees.
5. Reduce the negative visual impacts of parking areas and unsightly features with landscape screening. Provide concrete edging at planting beds as the standard. Raised planting beds constructed of brick may be used in pedestrian areas

#### **C06.1.11. Other**

Applicable  N/A Large graphics do not apply

Applicable  N/A Small graphics do not apply

### **C07. SITE FURNISHINGS**

Comply with AF Corporate Standards for Site Development:

<http://afcs.wbdg.org/site-development/index.html>

Comply with AF Corporate Standards for Site Furnishings:

<http://afcs.wbdg.org/site-development/site-furnishings/index.html>

#### **C07.1. Furnishings and Elements**

Applicable  N/A Large graphics do not apply

Applicable  N/A Small graphics do not apply

1. Provide a coordinated consistent inventory of site furnishings to positively contribute to the visual environment, image, and identity of the base; ensure durability, low maintenance, reduced visual clutter, and compatibility with the adjacent architecture.
2. Remove poorly located or redundant litter / ash receptacles, newspaper and bicycle racks, telephone booths, vending machines, walls and fences to reduce visual clutter and to lessen the requirements for maintenance.
3. Install needed outdoor seating (benches and low walls) in public gathering spaces near main and secondary building entrances. Low walls shall match facility architecture.
4. Benches in Groups 1, 2 and shall be factory finished metal. Provide recycled plastic top with metal frame benches in Group 4 and parks.
5. Bike Racks:
  - Integrate functional bicycle racks with the design of the building's main entrance grounds in Facility Groups 1 and 2 while meeting ATRP requirements.
  - Provide bicycle-parking areas for all facilities. Combine areas for densely sited buildings.
  - Place bike racks on concrete pads in accessible locations near established bike routes and near secondary building entrances.
  - Increase the numbers of available bike racks in residential and recreational areas.
  - Screen bicycle parking areas with landscaping or screen walls.
  - Align bollards at sites having multiple racks.
6. Limit the use of bollards, but when necessary for force protection use concrete filled standard 6" bollards in Groups 1, 2, and 4 including parks and trails; and concrete filled, 6" schedule 40 steel bollards in Group 3. Illuminated bollards may be used as approved on a case basis.

7. Locate architecturally coordinated containers for recycling, litter, ash, vending, etc., to minimize visual clutter and not visible from the building's main entrance. Minimize the use of freestanding planters.
8. Generally limit picnic tables, barbeque grills and drinking fountains to lodging, dormitories, housing areas, parks and recreation areas following IFS. Placement and design of built-in grills must be approved by the ACRB.
9. The Installation Flagpole location shall comply with the guidance for the display of flags in AFI 34-1201. Each Air Force installation is authorized to fly one United States Flag, normally in front of the installation headquarters. Waivers for non-authorized locations must be submitted in accordance with AFI 33-360 and approved waivers (AF Form 679) must be maintained by the installation protocol office. Create a sense of place at flag pole locations with landscape or plaza design.
10. Refer to the Overview Section "Facility Hierarchy" topic of this AFCFS for guidelines regarding ancillary structures such as pavilions and shade shelters.
11. Bus shelters shall be provided only where there is a documented need and when approved on a case basis. Generally emulate the designs of adjacent shelters using dark bronze factory finished aluminum and glass.
12. Monuments and static displays shall be limited. New elements are generally discouraged unless these are fully vetted through the base's approval process and designed following IFS.
13. When visual screening is necessary, consider landscaping as the first option; screen walls are permitted only in Group 1 finished with brick with color in accordance with the governing facility district, i.e. brown or red brick areas.
14. For fencing, apply the standards for "Products, Materials and Color" in the following section. Limit those with the highest visual quality to Facility Group 1 where there is sustained maintenance. Define all levels of security and visual quality.
15. Do not use chain-link fencing at Group 1, 2 or 4 facilities; Limit the use of barbed-wire outriggers on chain-link fencing at industrial sites, unless required for additional security or protection of assets.
16. Wood fencing may be used in Facility Group 4 and in recreation areas following IFS for material and finish when there is sustained periodic maintenance.
17. Provide trash dumpster enclosures for Group 1, and 2 with brick in accordance with the governing facility district. All gates shall be metal factory finished dark bronze.
18. Specify screen wall materials and finishes that do not require painting or maintenance beyond periodic cleaning.
19. Group 1, 2, and 4 picnic tables and seating shall be factory finished, recycled plastic with metal frames. Generally limit picnic tables, barbeque grills and drinking fountains to lodging, dormitories, housing areas, parks and recreation areas. Provide mid-morning to late-afternoon shade for all picnic tables.
20. Limit the use of freestanding planters to areas with ongoing maintenance.
21. Use natural cast iron tree grates at all formal plazas and courtyards set into concrete paving. Accent with brick pavers.
22. Provide kiosks only where there is a documented need for visual communication of posted messages. When used, match adjacent facilities in materials and detailing and consolidate kiosks with other site furnishings within 30 feet of major pedestrian paths. Limit kiosks to facility Groups 1 and 2 and parks.
23. Playground Equipment:
  - Provide consistent-style pre-manuplay equipment at parks, family housing areas, child developcenters, community centers, recreational areas, and TLF's.
  - Place equipment with safe ground surfacing, benches, litter receptacles, and landscaping for shade.
  - Provide adequate pedestrian circupaths to play areas.
24. Manufacturers listed below are only provided to establish a baseline of equivalency among all applicable manufacturers.



## C07.2. Site Furnishings Products, Materials and Color

**Note:** Apply the below base-wide standards for Site Furnishings (products, materials and color). Then refer to the Appendix and apply any additional requirements specifically related to the Facility District in which the project is located.

### C07.2.1. Barbeque Grills

Applicable  N/A Number of base standards 1

Image Tool 250 x 188



Type: **Charcoal, post mounted**

Applies to:  Group 1  Group 2  Group 3  Group 4  Other

Mfr: Game Time

Color: Galvanized and Black

Finish: Factory Mill Finish

Model #: 51

Other: Concrete foundation, coordinate with Base Architect. Built-In Barbeque grills may be used upon approval of the ACRB.

UFGS: 12 93 00 Site Furnishings

### C07.2.2. Benches

Applicable  N/A Number of base standards 1

Image Tool 250 x 188



Type: **Backed Bench**

Applies to:  Group 1  Group 2  Group 3  Group 4  Other

Mfr: Landscape Forms

Color: Metallic Bronze, or Powder Coated Ivy

Finish: Standard Finish (Smooth)

Model #: Presidio

Other: Designer may proposed backed or backless at their discretion and upon approval.

UFGS: 12 93 00 Site Furnishings

### C07.2.3. Bike Racks

Applicable  N/A

Number of base standards 1

Image Tool 250 x 188



Type: **Style 1**

Applies to:  Group 1  Group 2  Group 3  Group 4  Other

Mfr: Ribbon Bike Racks, Brandir Inc.

Color: Galvanized

Finish: Factory

Model #: The Ribbon Bike Rack, RB-07

Other: N/A

UFGS: 12 93 00 Site Furnishings

### C07.2.4. Bike Lockers

Applicable  N/A

### C07.2.5. Bollards

Applicable  N/A

Number of base standards 1

Image Tool 250 x 188



Type: **Lighted and non Lighted**

Applies to:  Group 1  Group 2  Group 3  Group 4  Other

Mfr: Lithonia

Color: Dark Bronze, or painted Spanish Moss if within 10'-0" of a building

Finish: Powder coated, or painted

Model #:

Other: Refer to lighting section for lighted/decorative bollards.

UFGS: 12 93 00 Site Furnishings

### C07.2.6. Bus Shelters

Applicable  N/A

Number of base standards 1

Image Tool 250 x 188

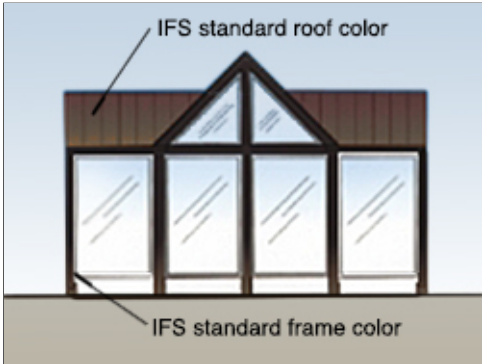

Type: **1**

Applies to:  Group 1  Group 2  Group 3  Group 4  Other

Mfr: Custom

Color: Dark Bronze

Finish: Powder coated

Model #: Gabled roof

Other: Provide concrete slab and 2 pre-manufactured aluminum benches. FAFB has 1 bus shelter located near the main gate. Mass transit does not operate through the base.

UFGS: 12 93 00 Site Furnishings

### C07.2.7. Drinking Fountains

Applicable  N/A

Number of base standards 1

Image Tool 250 x 188



Type: **Pedestal**

Applies to:  Group 1  Group 2  Group 3  Group 4  Other

Mfr: Most Dependable Fountains, Inc.

Color: Natural

Finish: Stainless Steel

Model #: MDF 440 SMSS

Other: Accessible

UFGS: 12 93 00 Site Furnishings

### C07.2.8. Dumpster Enclosures / Gates

Applicable  N/A

Number of base standards 1

Image Tool 250 x 188

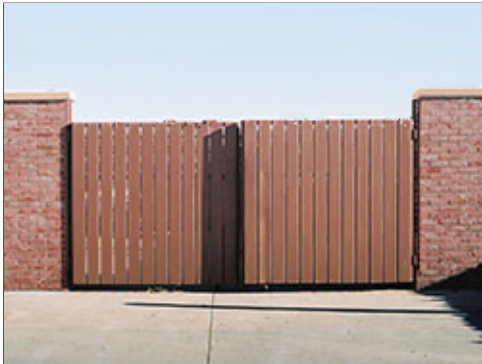

Type: **1: Brick and Steel**

Applies to:  Group 1  Group 2  Group 3  Group 4  Other

Mfr: Custom

Color: Red brick, Spanish Moss painted doors

Finish: Face brick, powder coated doors

Model #: Match adjacent building

Other: Steel gates and hardware, dark brown, dumpsters shall be painted dark brown

UFGS: 04 20 00 Unit Masonry

### C07.2.9. Fencing

Applicable  N/A

Number of base standards 7

Image Tool 250 x 188

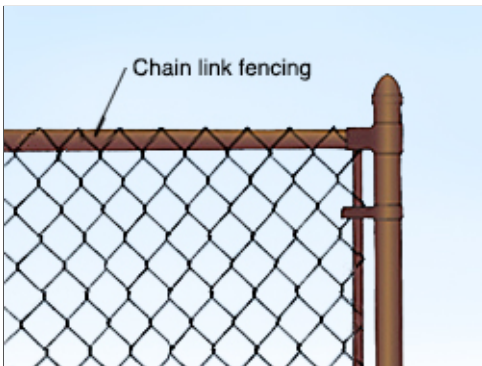

Type: **Style A Barrier: High security, low visibility**

Applies to:  Group 1  Group 2  Group 3  Group 4  Other

Mfr: TBD

Color: Dark brown

Finish: PVC coating over galvanized steel

Model #: Chain link, steel posts and rails, gates and accessories

Other: N/A

UFGS: 32 31 13 Chain Link Fences and Gates

Type: **Style B Barrier: High security, medium visibility**

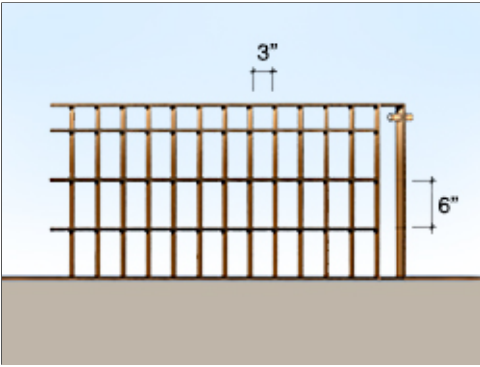

Applies to:  Group 1  Group 2  Group 3  Group 4  Other

Mfr: Custom

Color: Dark brown

Finish: Powder coat

Model #: Steel grid: flat bar stock verticals, round rod horizontals

Other: Steel posts, horizontal bars, braces, and accessories, in heights, lengths, and gauges as required; Close all ends of tubing

UFGS: Section 05 50 13 Miscellaneous Metal Fabrications

Type: **Style C Barrier: Medium security, medium visibility**

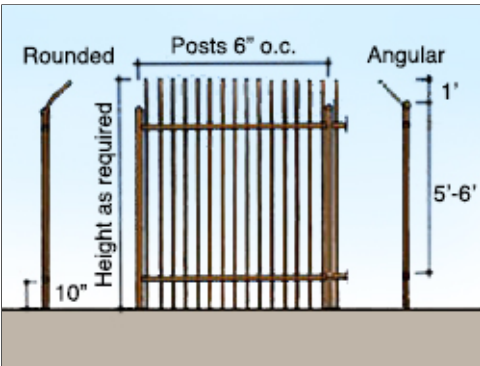

Applies to:  Group 1  Group 2  Group 3  Group 4  Other

Mfr: Custom

Color: Dark Brown

Finish: Powder coat

Model #: Steel posts, rails and pickets (vertical, bent outward at top)

Other: Posts, rails, and pickets in heights, lengths and gauges as required, (see Appendix for Facility Districts requirements)

UFGS: 05 50 13 Miscellaneous Metal Fabrications



Type: **Style D Barrier: Low security, High visibility**

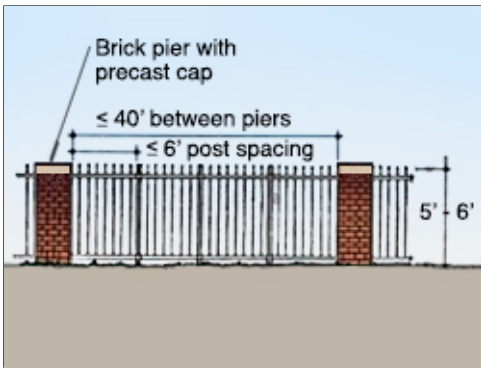

Applies to:  Group 1  Group 2  Group 3  Group 4  Other

Mfr: Custom

Color: Red brick blend, dark brown fencing

Finish: Face brick, powder coated metal

Model #: Brick Piers with steel posts, rails and pickets

Other: Brick: 2'x2' (Height as required, equally spaced 12' to 40'), Steel posts: 4"x4" (equally spaced), Rails: 2"x2", Pickets: 1"x1" (6"o.c.); close all ends of tubing

UFGS: 04 20 00 Unit Masonry, & 05 50 13 Misc. Metal

Type: **Style E Barrier: Low security, High visibility**

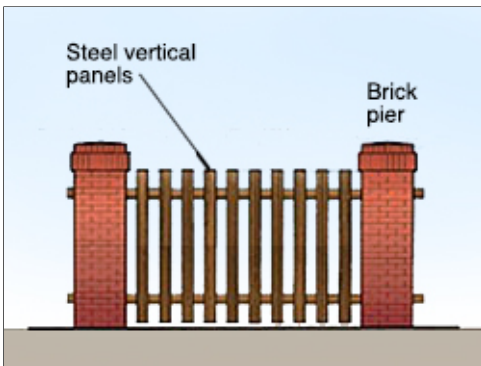

Applies to:  Group 1  Group 2  Group 3  Group 4  Other

Mfr: Custom

Color: Red brick blend, dark brown fencing

Finish: Powder coated metal

Model #: Brick Piers with steel posts, rails and alternating panels

Other: Brick: 2'x2' (Height as required, equally spaced 8' to 40'), Steel posts: 4"x4" (equally spaced), Rails: 1-1/4"x1-1/2", vertical steel panels spaced alternately on each side of the rails; matching gates; close all ends

UFGS: 04 20 00 Unit Masonry, & 05 50 13 Misc. Metal



Type: **Style F Barrier: Very low security, high visibility**

Applies to:  Group 1  Group 2  Group 3  Group 4  Other

Mfr: Custom

Color: Integral mixed Davis Colors: dark warm gray

Finish: Factory

Model #: Post and rail

Other: Concrete 3-rail, wood-grain textured (4,000 psi at 28 days); Posts: 39" height, 8' spacing, set 30" deep below grade with footing, typical

UFGS: 03 33 00 Cast-In-Place Architectural Concrete

Type: **Style G Barrier (Alternate): Very low security, high visibility**

Applies to:  Group 1  Group 2  Group 3  Group 4  Other

Mfr: James Hardie Building Products, Inc.

Color: Off white and Earth tones

Finish: Factory

Model #: Post and rail with vertical boards

Other: Posts: Height as required, 8' max. spacing; apply boards to outside face.

UFGS: Not Available (SECTION 074646 Fiber Cement Siding)



### C07.2.10. Flagpoles

Applicable  N/A

Number of base standards 1

Image Tool 250 x 188



Type: **1**

Applies to:  Group 1  Group 2  Group 3  Group 4  Other

Mfr: Eder Flag or equivalent

Color: Natural aluminum

Finish: Satin Lustre

Model #: ECL30 IH, Internal Halyard

Other: 5" Butt Dia. 33' H (30' Exposed)

UFGS: Not Available

### C07.2.11. Lighting – Landscape / Accent

Please refer to the Lighting section.

### C07.2.12. Litter and Ash Receptacles

Applicable  N/A

Number of base standards 1

Image Tool 250 x 188



Type: **Style 1**

Applies to:  Group 1  Group 2  Group 3  Group 4  Other

Mfr: Landscape Forms

Color: Powder coated Ivy

Finish: Smooth

Model #: Presidio, Open Side

Other:

UFGS: 12 93 00 Site Furnishings

### C07.2.13. Picnic Tables

Applicable  N/A

Number of base standards 1

Image Tool 250 x 188



Type: **Fabricated Steel and Wood**

Applies to:  Group 1  Group 2  Group 3  Group 4  Other

Mfr: Landscape Forms

Color: Factory

Finish: Standard Finish (Smooth)

Model #: Gretchen

Other:

UFGS: 12 93 00 Site Furnishings

### C07.2.14. Planters

Applicable  N/A

### C07.2.15. Play Equipment

Applicable  N/A

Number of base standards 1

Image Tool 250 x 188



Type: **N/A**

Applies to:  Group 1  Group 2  Group 3  Group 4  Other

Mfr: Little Tikes Commercial

Color: Varies

Finish: Powdercoated Steel

Model #: N-R-G Freestyle

Other: Coordinate with Base Architect

UFGS: 12 93 00 Site Furnishings

### C07.2.16. Screen Walls

Applicable  N/A

Number of base standards 1

Image Tool 250 x 188

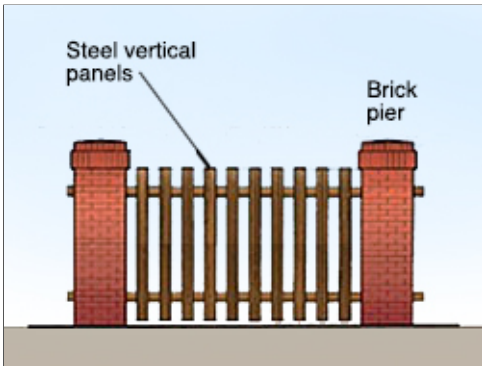

Type: **Brick / Steel**

Applies to:  Group 1  Group 2  Group 3  Group 4  Other

Mfr: Custom

Color: Red brick blend, dark brown fencing

Finish: Powder coated metal

Model #: Brick Piers with steel posts, rails and alternating panels

Other: Brick: 2'x2' (Height as required, equally spaced 8' to 40'), Steel posts: 4"x4" (equally spaced), Rails: 1-1/4"x1-1/2", vertical steel panels spaced alternately on each side of the rails; matching gates; close all ends

UFGS: 04 20 00 Unit Masonry, 05 50 13 Misc. Metal

### C07.2.17. Tree Grates

Applicable  N/A

Number of base standards 1

Image Tool 250 x 188



Type: **Cast Iron**

Applies to:  Group 1  Group 2  Group 3  Group 4  Other

Mfr: Neenah Enterprises, Inc.

Color: Natural cast iron

Finish: Cast

Model #: Adirondack 2-Piece, round or square

Other: N/A

UFGS: 12 93 00 Site Furnishings

### C07.2.18. Other

Applicable  N/A

## C08. EXTERIOR SIGNS



Comply with AF Corporate Standards for Site Development:

<http://afcs.wbdg.org/site-development/index.html>

Comply with AF Corporate Standards for Exterior Signs:

<http://afcs.wbdg.org/site-development/exterior-signs/index.html>

## C08.1. Colors and Types

Applicable  N/A Large graphics do not apply

Applicable  N/A Small graphics do not apply

1. Provide concise functional signs as a visually unifying element with consistent colors and types for all Installation and Gate Identification Signs; Building Identification Signs; Traffic Control Devices; Directional and Wayfinding Signs; and Informational and Motivational Signs.
2. Provide signs with the lowest overall life cycle costs considering initial cost, ongoing maintenance and lifespan while meeting quality standards. Follow IFS for specifications appropriate for the local climate to withstand weathering. Use dark brown for backgrounds with reflective white lettering on metal placards unless otherwise noted.
3. Reduce the number of signs, reduce visual clutter and provide only essential signs required for identification, directions, instructions, and customer service following UFC 3-120-01. Remove non-conforming signs during renovation projects.
4. Use clear concise terms for content consistent with UFC 3-120-01.
5. Display of emblems on building exterior walls or other permanent structures is prohibited by UFC. Avoid mottoes, super graphics, or individual titles on buildings or identisigns. Building-mounted signs or individual letters with corporate logos are alfor commercial facility signs only with ACRB approval.
6. Raised "standout" letters and numbers may be used for Group 1 with approval on a case basis.
7. Group 2 and 3 facilities shall have wall mounted facility signs with sizes and layouts following UFC 3-120-01. Signs are not permitted for Group 4 facilities. Display facility numbers in one location - at the back or side corner of buildings, coordinated with architectural features.
8. Only one identification sign is permitted at each building entrance. Include a building address consistent with US Postal Service protocols following UFC 3-120-01. Facility identification signs with street addresses are generally free standing and not applied to facility facades.
9. Traffic Control Devices, which regulate vehicular traffic on the installation, shall conform to the standards in the Manual of Uniform Traffic Control Devices (MUTCD) published by the Federal Highway Administration. Coordinate street signs with this IFS.
10. Provide Directional and Wayfinding Signs and address both pedestrian and vehicular traffic following UFC 3-120-01 for size, layout and content. Display the Air Mobility Command logo decal on the left of all street name signs.
11. Reserved parking signs should be kept to a minimum. When approved, provide post-mounted sign faces in base standard materials and colors. Consider "bracketing" a designated area with a single sign at each end.
12. Parking lot identification signs may be used to identify areas or rows within large lots.
13. Follow the guidelines and requirements in ABAAS and the MUTCD for accessible parking signs.
14. Follow UFC 3-120-01 for Informational and Motivational Signs for size, layout and content.
15. Symbols or pictographs (graphic expressions of actual objects) may be used to indicate service, mandatory / prohibitory, sports, and recreation when rapid communication is necessary.
16. Force Protection signage may be applied to glass doors using white vinyl lettering.

17. Refer to UFC 3-120-01 for prohibited signs, which include those with animated, blinking, chasing, flashing, or moving effects.

18. Manufacturers listed below are only provided to establish a baseline of equivalency among all applicable manufacturers.

### C08.1.1. Materials and Color Specifications

Applicable  N/A Large graphics do not apply

Applicable  N/A Small graphics do not apply

1. Fabricate sign panels from corrosion resistant aluminum placards. Sign posts shall be square metal with capped ends in a concrete base.
2. Fence mounted sign panels may be attached with exposed fasteners.
3. All signage shall follow Federal Highway Administration (FHWA) Manual on Uniform Traffic Control Devices (MUTCD) using standard colors. Refer to MUTCD color specifications, which provide cross-referenced Pantone Matching System (PMS) numbers.
  - a. Standard Blue
  - b. Standard Dark Bronze (also Federal Standard Color 30040)
  - c. Standard Red
  - d. Standard Black (non-reflective)
  - e. Standard White
  - f. Standard Brown

### Materials and Color Specifications

Applicable  N/A

### C08.1.2. Installation and Gate Identification Signs

Applicable  N/A Number of base standards 1

Image Tool 250 x 188



Type: **Primary, Secondary and Tertiary (Uses per UFC)**

Applies to:  Group 1  Group 2  Group 3  Group 4  Other

Mfr: Custom

Color: Dark bronze, brushed aluminum, accents per UFC

Finish: Powder coat or vinyl sign face

Model #: Metal frame and panels, buff stone base

Other: White vinyl lettering. Provide dimensions per UFC. Secondary signs shall match primary sign's materials, but shall be smaller in size per UFC. Tertiary signs shall follow the UFC.

UFGS: 05 50 13 Miscellaneous Metal Fabrications

### C08.1.3. Building Identification Signs

Applicable  N/A

Number of base standards 5

Image Tool 250 x 188

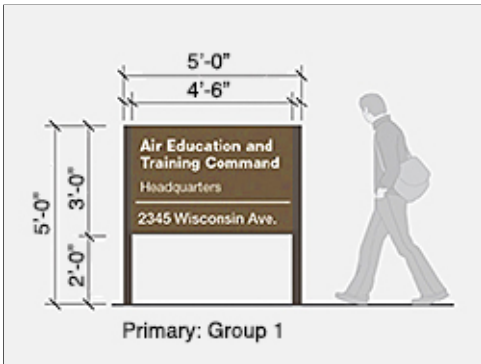

Type: **Freestanding Primary Sign (Sizes and Uses per UFC)**

Applies to:  Group 1  Group 2  Group 3  Group 4  Other

Mfr: Custom

Color: Medium brown face, dark bronze posts, white vinyl lettering

Finish: Powder coat or vinyl sign face

Model #: Aluminum sheet face, extruded aluminum posts

Other: Provide layout and sizes per UFC.

UFGS: 05 50 13 Miscellaneous Metal Fabrications

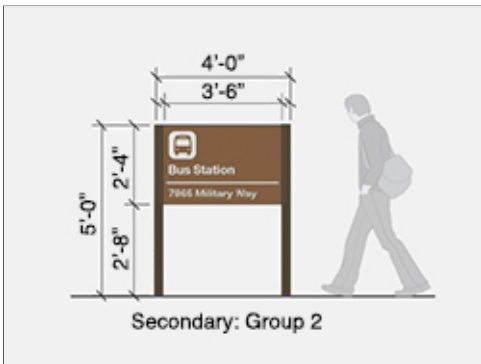

Type: **Freestanding Secondary Sign (Sizes and Uses per UFC)**

Applies to:  Group 1  Group 2  Group 3  Group 4  Other

Mfr: Custom

Color: Medium brown face, dark bronze posts, white vinyl lettering

Finish: Powder coat or vinyl sign face

Model #: Aluminum sheet face, extruded aluminum posts

Other: Provide layout and sizes per UFC.

UFGS: 05 50 13 Miscellaneous Metal Fabrications

Type: **Freestanding Tertiary Sign (Sizes and Uses per UFC)**

Applies to:  Group 1  Group 2  Group 3  Group 4  Other

Mfr: Custom

Color: Medium brown face, dark bronze posts, white vinyl lettering

Finish: Powder coat or vinyl sign face

Model #: Aluminum sheet face, extruded aluminum posts

Other: Provide layout and sizes per UFC.

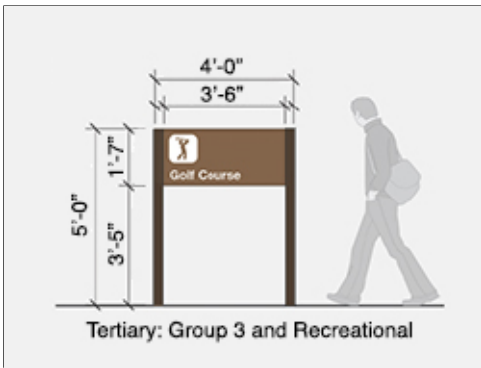

Tertiary: Group 3 and Recreational

UFGS: 05 50 13 Miscellaneous Metal Fabrications

Type: **Wall Mounted**

Applies to:  Group 1  Group 2  Group 3  Group 4  Other

Mfr: Custom

Color: Medium brown, white lettering

Finish: Satin vinyl applied to aluminum sheet

Model #: Aluminum sheet with vinyl face and vinyl lettering

Other: Provide layout and sizes following UFC.

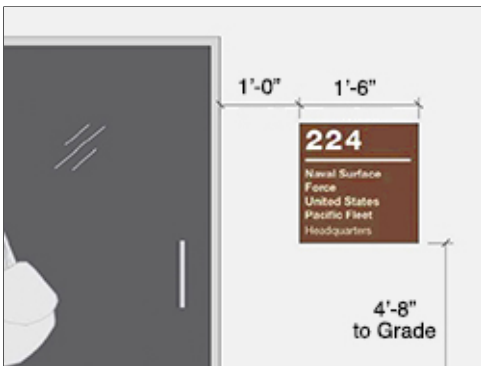

UFGS: N/A

Type: **Glass Mounted**



Applies to:  Group 1  Group 2  Group 3  Group 4  Other

Mfr: Custom

Color: White vinyl lettering

Finish: Matte vinyl

Model #: Machine-cut sheet vinyl

Other: Apply vinyl lettering to glass. Provide sizes following UFC.

UFGS: N/A

#### C08.1.4. Traffic Control Devices (Street Signs)

Applicable  N/A Number of base standards 1

Image Tool 250 x 188



Type: **Street Signs**

Applies to:  Group 1  Group 2  Group 3  Group 4  Other

Mfr: Custom

Color: White reflective lettering on a Standard Brown background

Finish: Powder coat or vinyl sign face

Model #: Aluminum sign face, control arm or pole mounted

Other: Mount 7' above grade minimum, pictographs and logos are prohibited on street name signs per UFC.

UFGS: 05 50 13 Miscellaneous Metal Fabrications



### C08.1.5. Directional and Wayfinding Signs

Applicable  N/A Number of base standards 2

Image Tool 250 x 188



Type: **Vehicular**

Applies to:  Group 1  Group 2  Group 3  Group 4  Other

Mfr: Custom

Color: Medium brown face, dark bronze posts, white reflective lettering

Finish: Powder coat or vinyl sign face

Model #: Aluminum sheet face, extruded aluminum posts

Other: Conform to the requirements of the MUTCD and its DoD Supplement. Provide types and sizes where required by UFC.

UFGS: 05 50 13 Miscellaneous Metal Fabrications

Type: **Pedestrian**

Applies to:  Group 1  Group 2  Group 3  Group 4  Other

Mfr: Custom

Color: Medium brown face, dark bronze posts

Finish: Powder coat or vinyl sign face

Model #: Aluminum sheet face, extruded aluminum posts

Other: White vinyl lettering. Provide types and sizes where required by UFC.

UFGS: 05 50 13 Miscellaneous Metal Fabrications

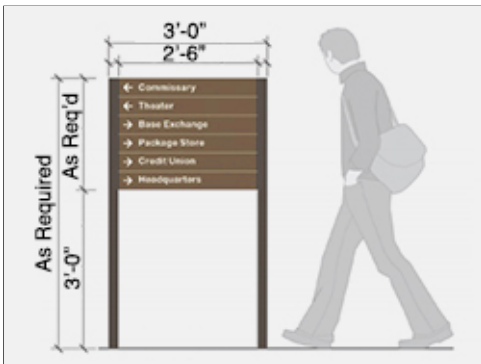

### C08.1.6. Informational Signs

Applicable  N/A Large graphics do not apply

Applicable  N/A Small graphics do not apply

1. Minimize informational signs such as static display signs, hours of operation, and project signs to reduce visual clutter.
2. Static display signs shall have standard dark brown (color).
3. Hours of operation signs shall have a level of quality equivalent to the Facility Group number.

4. Temporary / Project Signage shall be judiciously placed to avoid visual clutter. Schedule and arrange for the removal of these signs prior to installation.

### **C08.1.7. Motivational Signage**

Applicable  N/A Large graphics do not apply

Applicable  N/A Small graphics do not apply

1. Provide professionally produced motivational signs as important elements of campaigns to boost morale, improve safety, aid in recruiting, and accomplish other motivational objectives. Consolidate this signage to reduce visual clutter.
2. Motivational signs shall be limited to an electronic "marquee" type changeable sign near each gate. Temporary signs are not permitted. Motivational information may also be posted in a small, printed format on kiosks in specified, high pedestrian use areas. Refer to kiosks under Site Furnishings.
3. Follow UFC 3-120-01 for color and layout. Note that animated, blinking, chasing, flashing, or moving effects are prohibited by the UFC.
4. Mount marquee signs on reinforced concrete bases with a natural warm gray color.

### **C08.1.8. Parking Lot Signs**

Applicable  N/A

### **C08.1.9. Regulatory Signs**

Applicable  N/A

1. Regulatory signage, which restricts, warns and advises, shall be limited to those mandated under Highway/Traffic, Government Warning, and/or Parking Regulation. Follow UFC 3-120-01 and its industry references for color and layout.
2. Provide a comprehensive, systematic approach to regulatory signage to avoid clutter and confusion from "over signage."
3. Maintain base warning signs for safety and security at the base perimeter and at specific secure areas. Use these to notify visitors of restrictions governing conduct on the base, as well as other security procedures.
4. Traffic control signs must follow the Manual on Uniform Traffic Control Devices administered by the Federal Highway Administration for color and display requirements.
5. Handicapped parking signs must follow AMC Exterior Sign Standards for color and display requirements.
6. Base warning signs must adhere to the Air Force Sign Standard for color and display requirements.

### **C08.1.10. Other**

Applicable  N/A

## **C09. LIGHTING**

Comply with AF Corporate Standards for Site Development:  
<http://afcs.wbdg.org/site-development/index.html>

Comply with AF Corporate Standards for Lighting:  
<http://afcs.wbdg.org/site-development/lighting/index.html>

### C09.1. Fixtures and Lamping

Applicable  N/A Large graphics do not apply

Applicable  N/A Small graphics do not apply

Exterior lighting is a system that directly impacts the visual qualities of the base. By day, the fixtures and poles add visual character and rhythm to the streetscape. By night these amenities contribute to the perception of safety and comfort. Use common components throughout the base.

1. Provide, coordinate and efficiently install street, parking lot, sidewalk and facility lighting with appropriate luminaires, lamping, placement, and spacing following UFC 3-530-01 and Installation Facilities Standards (IFS); ensure the level of quality is consistent with the adjacent facility group number. Pole-mounted, wall-mounted and bollard fixtures are permitted. Use underground utility service for connection to lighting fixtures.
2. Integrate controls to automatically reduce lighting power during periods of non-activity; automatically turn off power when sufficient daylight is available. Photo metrics are required for all applications.
3. Ensure continuity and consistency of lighting elements. In new construction generally match post types, fixture types, styles, heights, sizes, materials, colors, and lamp types of adjacent facilities and the facility district.
4. Economically provide renewable-energy power sources such as solar photovoltaic when feasible.
5. Use appropriately designed or shielded luminaires to direct light downward to minimize light pollution and intrusion onto adjacent sites and to facilitate night training.
6. Calculate illuminant levels for all lighting applications following UFC 3-530-01 and ensure compliance with pre-curfew maximum brightness level requirements.
7. Sufficiently address environmental factors to prevent corrosion and weathering of fixtures, plinths and other components.
8. Architectural and Accent Lighting:
  - a. Wall mounted fixtures should respond to the architectural character of the facility.
  - b. Efficient accent lighting of architectural and landscape features may be provided for Group 1, lodging and historical applications. Accent lights in ground-mounted locations may be provided for static displays and signs when these do not conflict or cause hazards with overhead aircraft.
  - c. Incorporate recessed, wall-mounted luminaires to wash light across plaza, paving, and stairs.
  - d. Minimize and integrate into the build design the use of building-mount fixtures for general illumination of service yards and outdoor spaces.
  - e. Uplight architectural, landscaping, and building entrance features to emphasize importance and hierarchy.
  - f. Provide pedestrian-scale lighting fixtures throughout Group 4 housing areas; utility elements such as transformers shall be factory-finished dark brown to blend with surroundings.
9. Comply with UFC 3-530-01 for light source technology and lamp types. High efficiency lamping such as LED is preferred for most applications.
10. Provide round tapered, square non-tapered, or round non-tapered aluminum poles and aluminum fixtures with square, rectangular or circular housings in colors and shapes to match adjacent facilities and the facility district.
11. All classifications of roadways will use the same luminaires, poles, and mounting height. Use clear aluminum poles with luminaires and poles for all roadways. Equally space poles on alternating sides of all roadways
12. Bollards:

- a. Install lighted bollards only at Group 1 and high-traffic Group 2 facilities. Generally match materials, colors and shapes of adjacent facilities and the facility district.
  - b. Use bollards to protect buildings, equipment, and people from vehicle impact and to restrict access.
  - c. Use a 6-inch diameter, factory finished dark bronze aluminum, domed top bollard as the standard.
  - d. Use same style bollard with single function luminaire at pedestrian areas, pathways, and entrances.
  - e. For force protection use a 6-inch diameter, concrete filled, steel pipe. Cap lighted force protection bollards with a pre-manufactured, domed-top, single luminaire.
  - f. For bollards protecting equipment or buildings from vehicle damage, paint to match adjacent surfaces.
  - g. Use reflective beads in paint on bollards used in auto traffic areas.
13. Install natural gray color, smooth finished concrete bases for all poles in heights appropriate for the facility group and application. Generally Groups 1, 2 and 4 shall have at-grade bases. Group 3 shall have taller bases for added durability.
14. When parking lot lighting is necessary, provide an illuminated path to the building's main entrance. Pole bases should be contained within an internal landscape median or island.
15. Parking Areas:
- a. Use arm-mounted, square, shoeboxtype luminaries in factory finished dark brown. Use aluminum, round tapered, dark bronze poles.
  - b. Use multiple luminaries on a single pole to reduce clutter.
  - c. Coordinate pole placement with parking island locations.
16. Walkways and Paths:
- a. Consistently install lighting for sidewalks, bikeways and trails to match adjacent facilities.
  - b. Provide pedestrian-scaled lighting fixtures throughout housing area and along recreation trails and sidewalks not adjacent to roadways.
  - c. Equally space light fixtures for sidewalks on same side of walk.
  - d. Use arm-mounted shoebox fixtures.
17. Landscape accent lighting may be used in public gathering spaces and in Group 1 facilities. Coordinate the design, luminaire selection, and placement with the location of trees, shrubs, and site furnishings.
18. Mounting Heights:
- a. Control light trespass into residential areas
  - b. Keep mounting heights low and consistent. Any lights mounted over 30 feet high require special review by the ACRB.
19. Manufacturers listed below are only provided to establish a baseline of equivalency among all applicable manufacturers.

## C09.2. Light Fixture Types

**Note:** Apply the below base-wide standards for Light Fixtures (products, materials and color). Then refer to the Appendix and apply any additional requirements specifically related to the Facility District in which the project is located.

### C09.2.1. Street Lighting

Applicable  N/A

Number of base standards 1

Image Tool 250 x 188



Type: **Style 1**

Applies to:  Group 1  Group 2  Group 3  Group 4  Other

Mfr: Holophane

Color: Clear Anodized

Finish: Factory

Model #: LEDG, Cobra Head, round pole

Other: Lamp: LED. Follow manufacturer's recommendations for fixture base.

UFGS: 26 56 19 Roadway Lighting

### C09.2.2. Parking Lot Lighting

Applicable  N/A

Number of base standards 2

Image Tool 250 x 188



Type: **Parking Lot Style 1**

Applies to:  Group 1  Group 2  Group 3  Group 4  Other

Mfr: Holophane

Color: Dark Bronze Anodized (or Clear Anodized as approved by BCE)

Finish: Factory

Model #: LEDG, Cobra Head, round pole Single Arm or Dual Arm Mount

Other: Lamp: LED. Follow manufacturer's recommendations for fixture base.

UFGS: 26 56 00 Exterior Lighting



Type: **Parking Lot Fixture Base**

Applies to:  Group 1  Group 2  Group 3  Group 4  Other

Mfr: Custom

Color: Natural gray

Finish: Trowel

Model #: Form-cast, round

Other: N/A

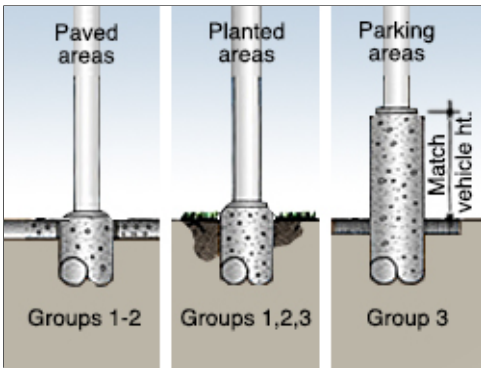

UFGS: 03 33 00 Cast-In-Place Architectural Concrete

### C09.2.3. Lighted Bollards

Applicable  N/A Number of base standards 2

Image Tool 250 x 188



Type: **Lighted Round Dome Top**

Applies to:  Group 1  Group 2  Group 3  Group 4  Other

Mfr: Lithonia Lighting Products

Color: Dark Bronze

Finish: Powder Coated

Model #: KBA

Other: Flared cone, 3000K LED Lamp. Follow manufacturer's recommendations for fixture base.

UFGS: 12 93 00 Site Furnishings



Type: **Lighted Round Dome Top, Decorative Bollard**

Applies to:  Group 1  Group 2  Group 3  Group 4  Other

Mfr: Lithonia Lighting Products

Color: Dark Bronze

Finish: Powder Coated

Model #: KBA8

Other: 3000K LED Lamp, 360° downlighting

UFGS: 12 93 00 Site Furnishings

### C09.2.4. Sidewalk Lighting

Applicable  N/A

Number of base standards 1

Image Tool 250 x 188



Type: **Pedestrian Walkway Lighting**

Applies to:  Group 1  Group 2  Group 3  Group 4  Other

Mfr: Lithonia Lighting Products

Color: Dark Bronze

Finish: Powder Coated

Model #: DSX0 LED Area Luminaire

Other: Lamp: LED

UFGS: 26 56 00 Exterior Lighting

### C09.2.5. Walls / Stairs Lighting

Applicable  N/A

Number of base standards 1

Image Tool 250 x 188



Type: **Recessed Wall Mounted Puck**

Applies to:  Group 1  Group 2  Group 3  Group 4  Other

Mfr: Vista Lighting

Color: Dark bronze anodized

Finish: Smooth

Model #: Aluminum Step and Brick Lights, 5230 round louvered

Other: Lamp: LED

UFGS: 26 56 00 Exterior Lighting

### C09.2.6. Other

Applicable  N/A

## **D. FACILITIES EXTERIORS**

Comply with Air Force Corporate Standards for Facilities Exteriors:

<http://afcfs.wbdg.org/facilities-exteriors/index.html>

### **D01. SUPPORTING THE MISSION**

Comply with AF Corporate Standards for Supporting the Mission:

<http://afcfs.wbdg.org/facilities-exteriors/supporting-the-mission/index.html>

### **D02. SUSTAINABILITY**

Comply with Air Force Corporate Standards for Sustainability:

<http://afcfs.wbdg.org/facilities-exteriors/supporting-the-mission/index.html>



### D03. ARCHITECTURAL FEATURES

Comply with AF Corporate Standards for Facilities Exteriors:

<http://afcs.wbdg.org/facilities-exteriors/index.html>

Comply with AF Corporate Standards for Architectural Features:

<http://afcs.wbdg.org/facilities-exteriors/architectural-features/index.html>

*Insert 3 photos for each facility group.*

Image Tool 250 x 188

Group 1



Group 2

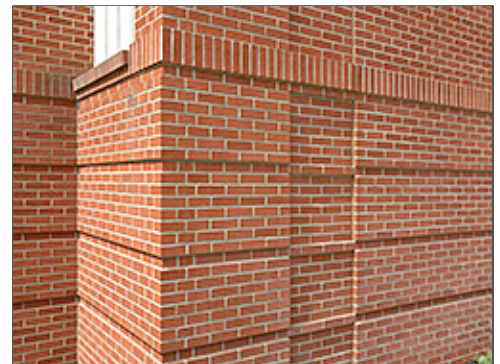
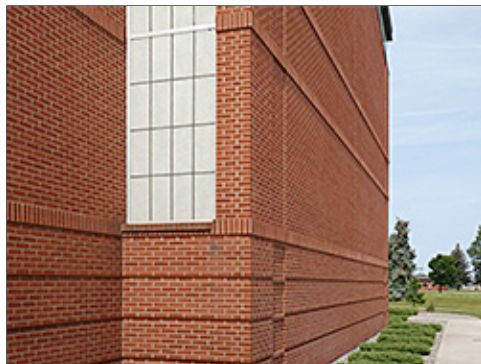

Group 3



Group 4





### **D03.1. Orientation, Massing and Scale**

1. Achieving compatibility among buildings is essential in creating an Architecture of Community. Develop facilities with a common design theme and character to enhance architectural compatibility. Unity is the goal, not conformity.
2. Orient new buildings to maximize energy efficiency, passive solar and daylighting potential of the building; narrow buildings oriented along an east-west axis are preferred to minimize heat gain in the summer months and maximize heat gain in the winter months resulting in less overall energy usage.
3. Provide orthogonal geometry for principal building form; angular geometry may be used sparingly for Group 1 and used only for emphasis at specific areas such as building entrances and stairwells.
4. Maintain a human scale and reduce the visual scale of large buildings with sub-massing related to interior functional operations; create consistent form and scale in adjacent buildings with compatible profiles or silhouettes. Break up the mass of large structures to allow for slope roofs to the maximum extent.
5. Building heights shall not be limited; however, building heights over 2 stories shall be considered on a case basis.
6. Combine functions where practical to avoid a proliferation of small, independent structures.
7. Use and coordinate shading devices with orientation and for function.

### **D03.2. Architectural Character**

1. Develop architectural features, materials and detailing appropriate for the Facility Group designation. Refer to Building Entrances, Wall Systems and Roof Systems.
2. Emphasize horizontal proportions on building elements. Rectangular elements are the standard for major building masses. Use clean, simple, contemporary forms and avoid curves or angular elements in plan.
3. Respond to the local climate and regional influences with environmentally functional architectural features.
4. For new facilities design generally maintain consistency and visual unity in the character of the adjacent buildings through compatible architectural features: repeated use of similar forms such as roofs, and through recurring elements such as doors, windows, materials and colors.
5. Reinforce the community theme. (example: "campus environment and educational theme with a related architectural theme expressive of innovation and technology that represents the current Air Force Training and Education Command mission.")
6. All facilities shall express sustainability through their orientation, massing, shape, form, materials, and detailing. Provide louvers, fins and other shading devices to control heat gain and glare and to and improve energy efficiency.
7. Strive for economical construction without compromising a high-quality, professional appearance.

### **D03.3. Details and Color**

1. Provide a palette of earth-tone colors related to the native landscape in brick, block, stucco and powder-coated metals. Refer to wall systems for detailed material listings.
2. Relate the level of architectural detailing to the Facility Group number.
3. Use only integrally colored materials as the predominant exterior building material; do not use materials that require field painting and ongoing maintenance.

4. Provide consistent and compatible colors for every exterior building feature, including walls, roofs, doors, windows, gutters, downspouts, utility and mechanical elements, and other visible elements.
5. Match the existing materials for addition / alteration projects unless a significant change to the exterior envelope is included. Whenever possible bring existing facilities into compliance.
6. Noncorrosive metals with factory applied color finishes are required.
7. Combine details and color with orientation, massing, scale and architectural character to maintain base compatibility.
8. Manufacturers listed below are only provided to establish a baseline of equivalency among all applicable manufacturers.

**D03.3.1. Climate-based Data and Life-Cycle Cost-Effective Passive and Natural Design Strategies:**

- Climate dominated by mechanical cooling
- Climate dominated by mechanical heating
- Climate with similar mechanical cooling / heating needs
- Climate with minimal mechanical cooling / heating needs
  
- Climate with high humidity
- Climate with moderate humidity
- Climate with low humidity
  
- High Solar Insolation
- Moderate Solar Insolation
- Low Solar Insolation
  
- Soils with High Thermal Conductivity
- Soils with Average Thermal Conductivity
- Soils with Low Thermal Conductivity

Other:

Other:

*Facility:* Narrow buildings along E-W axis are preferred

*Wall:* Integral shading features and devices / interior masonry thermal mass walls (for heating)

*Doors:* Recessed are preferred

*Windows:* Limit north-facing windows / maximize windows on south façades with shading

Roof: High to medium albedo, minimal to moderate slope

Structure: Do not expose ferrous metals. Provide factory finished non-ferrous metals or concrete

MEP: Ground-source and solar photovoltaic following LCCA

Other: Optimize shading devices to provide summer shade and allow winter solar heat gain

Other: Internal thermal mass walls may be used for heating following LCCA

**Note:** Apply the below base-wide standards for Architectural Features (products, materials and color). Then refer to the Appendix and apply any additional requirements specifically related to the Facility District in which the project is located.

### D03.3.2. Natural Ventilation System

Applicable  N/A      Number of base standards 1

Image Tool 250 x 188



Type: **Style 1 Aluminum Windows**

Applies to:  Group 1  Group 2  Group 3  Group 4  Other

Mfr: Kawneer (or equivalent)

Color: Dark Bronze (or clear anodized as approved by BCE)

Finish: Anodized

Model #: Varies

Other: Provide thermally broken frames.

UFGS: 08 41 13 Aluminum-Framed Entrances and Storefronts

### D03.3.3. Thermal Mass

Applicable  N/A

Number of base standards 1

Image Tool 250 x 188



Type: **Interior Wall Material Thermal Massings**

Applies to:  Group 1  Group 2  Group 3  Group 4  Other

Mfr: Interpace Brick

Color: Imperial Red Mission, & Brown (Brown Brick Area only)

Finish: Light texture

Model #: Coursed unit masonry

Other: Brick is preferred. Concrete block may only be used in Group 3 when approved by the BCE. Mortar must be natural Portland Cement

UFGS: 04 20 00 Unit Masonry

### D03.3.4. Thermal Shading

Applicable  N/A

Number of base standards 1

Image Tool 250 x 188



Type: **Horizontal Shading Louvers**

Applies to:  Group 1  Group 2  Group 3  Group 4  Other

Mfr: Kawneer (or equivalent) or custom

Color: Dark bronze

Finish: Factory, to match frames

Model #: Louver

Other: Shading devices may be attached to frames or structure

UFGS: 08 41 13 Aluminum-Framed Entrances and Storefronts

### D03.3.5. Renewable Heating/Cooling

Applicable  N/A

Number of base standards 1

Image Tool 250 x 188



Type: **Geothermal (ground source) Vertical ground loop well field**

Applies to:  Group 1  Group 2  Group 3  Group 4  Other

Mfr: Varies

Color: N/A

Finish: N/A

Model #: TBD

Other: A life-cycle cost analysis is required to determine applicability and benefit.

UFGS: 23 81 47 Water-Loop and Ground-Loop Heat Pump Systems

### D03.3.6. Solar Photovoltaic System

Applicable  N/A

Number of base standards 1

Image Tool 250 x 188



Type: **Roof mounted, or ground array systems**

Applies to:  Group 1  Group 2  Group 3  Group 4  Other

Mfr: TBD

Color: N/A

Finish: N/A

Model #: TBD

Other: A life-cycle cost analysis is required to determine applicability and benefit.

UFGS: 26 31 00 Solar Photovoltaic (PV) Components



### D03.3.7. Solar Thermal System

Applicable  N/A

Number of base standards 1

Image Tool 250 x 188



Type: **Loop feed, ground or roof mount**

Applies to:  Group 1  Group 2  Group 3  Group 4  Other

Mfr: TBD

Color: N/A

Finish: N/A

Model #: TBD

Other: A life-cycle cost analysis is required to determine applicability and benefit.

UFGS: 48 14 13.00 20 Solar Liquid Flat Plate and Evacuated Tube

## D04. BUILDING ENTRANCES

Comply with AF Corporate Standards for Facilities Exteriors:

<http://afcs.wbdg.org/facilities-exteriors/index.html>

Comply with AF Corporate Standards for Building Entrances:

<http://afcs.wbdg.org/facilities-exteriors/building-entrances/index.html>

*Insert 3 photos for each facility group.*

Image Tool 250 x 188

Group 1



Group 2



Group 3



Group 4



## D04.1. Primary Entrances

1. Entrances act as a transitional element from exterior to interior and provide opportunities to create a focal point on a façade. They establish a user's first impression and delineate the importance of the building by the size and architectural detailing of the entrance structure.
2. Emphasize the primary entrance in the overall building design with a projecting or recessed covering for weather protection following Installation Facilities Standards (IFS) for Facility Group designations.
3. Provide vestibules at entries in Groups 1, 2 and 3 unless used infrequently or serving unconditioned space following ASHRAE 90.1.
4. Projected entrance features with gabled or hipped roof forms are preferred.
5. Fully integrate all elements including the design of handicap ramps in the overall design of the primary entrance in an organized uncluttered appearance.
6. Install paved transitional spaces sized for the building function and occupancy. Use accent pavers or colored conin approach walkways or at entry plazas.
7. Install appropriate lighting and site furniture following ATFP and IFS.
8. Protect entrances from falling ice and snow.
9. Provide porte cocheres or covered drop-offs when justified for lodging and medical facilities; do not use for prestige or architectural accents.
10. Locate newspaper, vending machines, and similar elements out of view to avoid visual clutter.

## D04.2. Secondary Entrances

1. Provide vestibules at entries in Groups 1, 2 and 3 unless used infrequently or serving unconditioned space following ASHRAE 90.1; use of stair towers as vestibules for multi-story buildings is encouraged when building and / or energy codes are satisfied.
2. Reflect the character of the primary entrance to a lesser extent with a smaller scale.
3. Include a recess or projection for weather protection and shading.
4. Integrate service and egress doors and loading areas with the building design by matching the materials and detailing and reflect the overall quality of the facility.
5. Incorporate egress structures such as stair towers into the facility design. Do not use canopies at emergency egress doorways.
6. Canopies may be used for service and loading areas; weather protection beyond weatherstripping is not required at doors used only for life safety egress.
7. Develop building massing and orientation to minimize the appearance of service and loading areas; physically and visually separate these from primary entrances.
8. Loading areas must be organized, orderly and have an uncluttered appearance.
  - a. Minimize visual impact with proper siting and access.
  - b. Provide unobtrusive service entrances that are physically and visually separated from primary and secondary entrances.
  - c. Use landscaping and screen walls to screen and separate loading docks.



## D05. WALL SYSTEMS

Comply with AF Corporate Standards for Facilities Exteriors:

<http://afcs.wbdg.org/facilities-exteriors/index.html>

Comply with AF Corporate Standards for Doors and Windows:

<http://afcs.wbdg.org/facilities-exteriors/wall-systems/index.html>

Comply with AFCFS Recommended Materials:

<http://afcs.wbdg.org/facilities-exteriors/wall-systems/materials/index.html>

*Insert 3 photos for each facility group.*

Image Tool 250 x 188

Group 1



Group 2



Group 3



Group 4



## D05.1. Hierarchy of Materials

1. Group 1 facilities may have more refined detailing than Group 2 and Group 2 may have more definition than Group 3.
2. Group 1 and 2 facilities shall be primarily of red brick in a running bond pattern with tooled joints. Brick may be used when appropriate for lintels or sills. Detailing should emulate bearing wall construction. Conceal expansion joints with downspouts or locate them at transitions in the wall such as at pilasters or reveals. Use natural color portland cement mortar.
3. Efflorescence in masonry work is unacceptable. All materials shall be classified as low-efflorescence.
4. Precast is permitted in the brown brick areas for community and administrative facilities (i.e. Groups 1, and 2). Precast is appropriate for lintels, sills, belt courses, and friezes. Other facade elements made of precast should be used sparingly to ensure that brick remains the prominent material. Natural is the standard color for precast concrete.
5. Detailed designs and patterns may be cast into the pieces to create an individual character for a single facility or complex.
6. Site-cast components are acceptable per ACRB approval.
7. For Group 3 facilities and inconspicuous areas of Group 2 facilities use brick or a combination of brick and CMU or metal panels on smaller administrative facilities.
8. For Group 3 facilities:
  - Do not use metal panels as the sole material for any structure.
  - Integral color CMU may be used as a sole material for facilities with ACRB approval.
  - Cap brick parapet walls with metal or precast concrete coping.
  - On larger facilities use a combination of brick and flat metal panels.
  - Use a horizontal expression of metal panels.
  - Locate visible vents and louvers as planned design elements; avoid random placement.
  - Vents and louvers are to match the color of adjacent surfaces. Refer to the Appendix for special requirements of Facility Districts.
9. Group 4 shall be a combination of two of the following materials: vinyl siding, and brick to match existing, subject to ACRB approval. Alternate exterior color schemes randomly using the paint and siding colors specified in the Appendix.
10. Multi-story Group 1 facilities may include a transition in material, color or detailing to create a visual base. Generally limit these variations to two materials max, brick or concrete.
11. Use high-performance building envelopes following UFC 1-200-02.
12. Use detailing not subject to excessive weathering. Provide wall accents consistently throughout the base and for each facility Group type. Facilities shall demonstrate a greater application of detailing. Architectural accents such as lintels, sills, belt courses, pilasters, and columns or other contextual details are encouraged to break up flat facades and add visual interest.
13. Use integrally colored materials and factory-finished metals. Do not paint concrete block.
14. Translucent wall panels may be used in Facility Group 1 and recreational uses in Group 2 when protected from direct solar gain. Provide insulating panels and shading appropriate for the orientation and exposure.
15. Manufacturers listed below are only provided to establish a baseline of equivalency among all applicable manufacturers.

## D05.2. Layout, Organization and Durability

1. Organize wall components including doors, windows, accents, shading devices, control joints, etc., to provide an ordered, professional appearance. Organize and coordinate placement of all mechanical, electrical, lighting, communication and other building components.



2. Integrate shading devices into the overall composition of the wall.
3. Integrate fixed shading devices as at all exterior glazing exposed to summer UV heat gain as a passive design measure to reduce energy use. Ensure adequate shading at west entrances. Deciduous trees may be used for shading.
4. Shading systems may be included as part of a manufacturer's window system or may be custom systems integrated into the wall.
5. Integrate vertical components such as downspouts and control joints into the overall organization.
6. Provide appropriate transitions between dissimilar materials to mitigate effects of thermal expansion and galvanic action.
7. All joint sealants shall be slightly darker than adjacent surfaces.
8. Materials requiring regular maintenance are not permitted; do not use exposed structural steel or other materials that require painting.
9. Refer to C07.2.16. Screen Walls for materials and colors of freestanding walls.
10. Refer to D07. Roofs for downspouts.

### D05.3. Equipment, Vents and Devices

1. Arrange all mechanical, electrical, fire alarm, lightning protection and other system components to create an orderly appearance that integrates with the wall system.
2. Do not expose conduits, cables, piping, lightning protection components, etc. on exterior walls; if unavoidable in renovations, finish these elements to match the adjacent wall surface.
3. Avoid visual clutter and where surface-mounted elements are required they shall match the wall color.
4. All gas meters, fire bells, vents, louvers, and electrical / communication boxes shall match the wall surface color on which the equipment is mounted.

### D05.4 Wall Systems Materials

**Facility Group 1** wall materials shall be as follows.

Primary: Brick  
 Secondary: Cast-in-place Concrete or (with brick) Architectura  
 Accent: (with brick) Metal Panels

**Facility Group 2** wall materials shall be as follows.

Primary: Brick  
 Secondary: Architectural precast  
 Accent: Cast-in-Place concrete

**Facility Group 3** wall materials shall be as follows.

Primary: Ribbed metal sheeting  
 Secondary: Ribbed Metal Sheeting in Alternate Color or Brick  
 Accent: Brick

**Facility Group 4** wall materials shall be as follows.

Primary: Vinyl Siding &/or T1-11Type Siding  
 Secondary: Fiber Cement Siding, and/or Trim Boards  
 Accent: Brick

**Note:** Apply the below base-wide standards for Wall Systems (products, materials and color). Then refer to the Appendix and apply any additional requirements specifically related to the Facility District in which the project is located.

### D05.4.1. Flat Metal Panels

Applicable  N/A      Number of base standards 1

Image Tool 250 x 188



Type: 1

Applies to:  Group 1  Group 2  Group 3  Group 4  Other

Mfr: Citadel Architectural Products

Model #: Alucobond Classic, Rainscreen I

Color: Bone White

Finish: Anodized

Other: Route and Return Dry Seal

UFGS: Section 07 42 13 Metal Wall Panels:  
<http://www.wbdg.org/FFC/DOD/UFGS/UFGS 07 42 13.pdf>  
Section 07 42 63 Fabricated Wall Panel Assemblies:  
<http://www.wbdg.org/FFC/DOD/UFGS/UFGS 07 42 63.pdf>

### D05.4.2. Brick Veneer

Applicable  N/A      Number of base standards 2

Image Tool 250 x 188



Type: 1 (Basewide)

Applies to:  Group 1  Group 2  Group 3  Group 4  Other

Mfr: Interpace Brick

Model #: Face Brick

Color: Imperial Red Mission (Basewide)

Finish: Smooth/Natural

Other: Mortar color shall be: "Natural Portland Cement"

UFGS: Section 04 20 00 Unit Masonry:  
<http://www.wbdg.org/FFC/DOD/UFGS/UFGS 04 20 00.pdf>



Type: **2 (Brown Brick Area only)**

Applies to:  Group 1  Group 2  Group 3  Group 4  Other

Mfr: Interpace Brick

Model #: N/A

Color: Brown

Finish: Smooth/Natural

Other: Mortar color shall be: "Natural Portland Cement"

UFGS: Section 04 20 00 Unit Masonry:  
<http://www.wbdg.org/FFC/DOD/UFGS/UFGS 04 20 00.pdf>

### D05.4.3. Architectural Precast

Applicable  N/A Number of base standards 1



Type: **1**

Applies to:  Group 1  Group 2  Group 3  Group 4  Other

Mfr: Multiple Local Precast Companies Available

Model #: Smooth Casting

Color: Natural Portland Cement

Finish: Very Light texture

Other: N/A

UFGS: Section 03 45 00 Precast Architectural Concrete:  
<http://www.wbdg.org/FFC/DOD/UFGS/UFGS 03 45 00.pdf>

### D05.4.4. Stucco Over Sheathing

Applicable  N/A

### D05.4.5. Curtain Wall

Applicable  N/A

### D05.4.6. Cast-In-Place Concrete

Applicable  N/A

### D05.4.7. Tilt-Up Concrete

Applicable  N/A

---

### D05.4.8. Ribbed Metal Sheeting

Applicable  N/A      Number of base standards 2

Image Tool 250 x 188



Type: 1

Applies to:  Group 1  Group 2  Group 3  Group 4  Other

Mfr: AEP Span

Model #: Design Span HP

Color: Sierra Tan

Finish: Anodized

Other: 24 Gauge Steel

UFGS: Section 07 42 13 Metal Wall Panels:  
<http://www.wbdg.org/FFC/DOD/UFGS/UFGS 07 42 13.pdf>

Type: 2

Applies to:  Group 1  Group 2  Group 3  Group 4  Other

Mfr: AEP Span

Model #: Design Span HP

Color: Dark Bronze

Finish: Anodized

Other: 24 Gauge Steel

UFGS: Section 07 42 13 Metal Wall Panels:  
<http://www.wbdg.org/FFC/DOD/UFGS/UFGS 07 42 13.pdf>

---

### D05.4.9. EFIS

Applicable  N/A

---

### D05.4.10. GRFC

Applicable  N/A

---

### D05.4.11. Concrete Block

Applicable  N/A

Number of base standards 1

Image Tool 250 x 188



Type: 1

Applies to:  Group 1  Group 2  Group 3  Group 4  Other

Mfr: TBD

Model #: TBD

Color: Brown, Beige

Finish: Split Face

Other: Mortar Color: Natural Portland Cement

UFGS: Section 04 20 00 Unit Masonry:  
<http://www.wbdg.org/FFC/DOD/UFGS/UFGS 04 20 00.pdf>

### D05.4.12. Fiber Cement Siding

Applicable  N/A

### D05.4.13. Other

Applicable  N/A



## D06. DOORS AND WINDOWS

Comply with AF Corporate Standards for Facilities Exteriors:

<http://afcs.wbdg.org/facilities-exteriors/index.html>

Comply with AF Corporate Standards for Doors and Windows:

<http://afcs.wbdg.org/facilities-exteriors/doors-and-windows/index.html>

Comply with AFCFS Recommended Materials:

<http://afcs.wbdg.org/facilities-exteriors/doors-and-windows/materials/index.html>

Insert 3 photos for each facility group.

Image Tool 250 x 188

Group 1



Group 2



Group 3

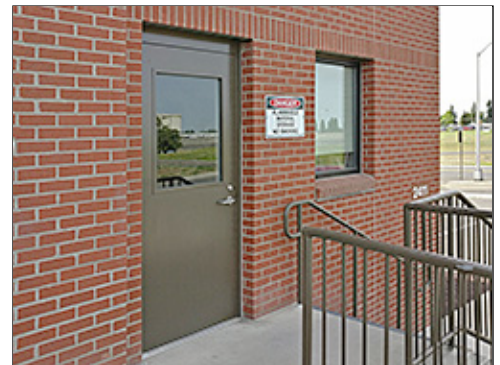

Group 4



## **D06.1. Types**

1. Dark bronze anodized aluminum doors, windows and frames with thermal breaks are preferred for Facility Groups 1-3; match the color of the door and frame. For renovation projects the color of new windows, doors and frames may match the existing ones.
2. Aluminum clad wood windows are preferred for Facility Group 4.
3. Standard-sized hinged doors are preferred. Use sliding, folding, overhead, sectional and other door configurations only to support mission operations.
4. Automatic doors are allowed only where functionally necessary.
5. Limit hollow metal doors and frames to security doors, utility rooms and mechanical rooms in Groups 1 and 2 and to any application in Group 3 facilities.
6. Utility and emergency egress doors shall match the wall color.
7. Passive thermal comfort methods of ventilation are encouraged where life cycle cost justified.
8. Windows must meet force protection requirements.
9. Adjacent joint sealants should be slightly darker than the frame color.
10. Manufacturers listed below are only provided to establish a baseline of equivalency among all applicable manufacturers.

## **D06.2. Layout and Geometry**

1. Visually and functionally compose openings in walls for the climate-specific exposure.
2. Consistently use opening type, size, placement, mullion pattern, and color to reinforce the overall architectural design.
3. Set windows back at least 3" from the building facade.
4. Incorporate operable windows with screens where possible.
1. Transom windows / elements above doors / windows are encouraged.
2. Openings shall augment interior lighting and space conditioning needs.
3. Protect against vandalism, intrusion and coordinate sound ratings.

## **D06.3. Glazing and Shading**

1. Tinted, energy-efficient, low-e, double-pane glazing is encouraged; provide triple-pane glazing in extreme environments.
2. Glazing color shall follow Installation Facilities Standards (IFS).
3. Translucent wall panels may be integrated into wall systems. Use clear glazing on the outside and white glazing on inside with dark bronze frames.
4. Do not use mirrored glazing.
5. Fully integrate applicable shading designs for overhangs, louvers, light shelves and grilles.
6. Where appropriate, install window screens to take advantage of natural ventilation.
7. Integrate clerestories or low-profile skylights with building design. Clerestory windows shall be either glass or translucent insulated panels.

8. Electronic security systems or security glazing is preferred to physical screens or bars. Where physical barriers are required, develop simple rectangular designs that are unobtrusive.

#### D06.4. Hardware

1. Provide hardware appropriate for the Facility Group while considering activity and frequency of use and local climate; hardware may be of higher visual quality for Facility Group 1.
2. Ensure hardware will perform throughout the facility's lifespan without showing extreme wear.
3. Select finishes that will not degrade by intensity of operation or exposure to the elements.
4. Use consistent finishes and color on window and door systems throughout a facility. For renovation projects the color of new hardware may match the existing hardware.
5. Design building systems to eliminate the need for security screens whenever possible.

#### D06.5. Doors and Windows Materials

**Note:** Apply the below base-wide standards for Doors and Windows (products, materials and color). Then refer to the Appendix and apply any additional requirements specifically related to the Facility District in which the project is located.

##### D06.5.1. Anodized Aluminum

Applicable  N/A

Number of base standards 1

Image Tool 250 x 188



Type: **Anodized Aluminum Doors, Windows and Frames**

Applies to:  Group 1  Group 2  Group 3  Group 4  Other

Mfr: Kawneer (or equivalent)

Color: Dark Brown Anodized

Finish: Matte

Model #: 2x4

Other: Provide thermally broken frames

UFGS: Section 08 41 13 Aluminum-Framed Entrances and Storefronts:  
<http://www.wbdg.org/FFC/DOD/UFGS/UFGS 08 41 13.pdf>



### D06.5.2. Hollow Metal

Applicable  N/A

Number of base standards 1

Image Tool 250 x 188



Type: \_\_\_\_\_

Applies to:  Group 1  Group 2  Group 3  Group 4  Other

Mfr: Hollow Metal Doors, Windows and Frames

Color: Dark Brown

Finish: Powder Coated, Satin

Model #: 2x4 frame

Other: Provide thermally broken frames

UFGS: Section 08 11 13 Steel Doors and Frames:

<http://www.wbdg.org/FFC/DOD/UFGS/UFGS 08 11 13.pdf>

### D06.5.3. Aluminum-clad Wood

Applicable  N/A

Number of base standards 1

Image Tool 250 x 188



Type: **Aluminum-clad Residential**

Applies to:  Group 1  Group 2  Group 3  Group 4  Other

Mfr: Marvin

Color: White or Earth tones

Finish: Powder coated, satin

Model #: Aluminum-clad wood windows

Other: Double hung

UFGS: Section 08 14 00 Wood Doors

<http://www.wbdg.org/FFC/DOD/UFGS/UFGS 08 14 00.pdf>

### D06.5.4. Other

Applicable  N/A

## D07. ROOF SYSTEMS

Comply with AF Corporate Standards for Facilities Exteriors:

<http://afcs.wbdg.org/facilities-exteriors/index.html>

Comply with AF Corporate Standards for Roof Systems:

<http://afcs.wbdg.org/facilities-exteriors/roof-systems/index.html>

Comply with AFCFS Recommended Materials:

<http://afcs.wbdg.org/facilities-exteriors/roof-systems/materials/index.html>

*Insert 3 photos for each facility group.*

Image Tool 250 x 188

Group 1



Group 2



Group 3



Group 4

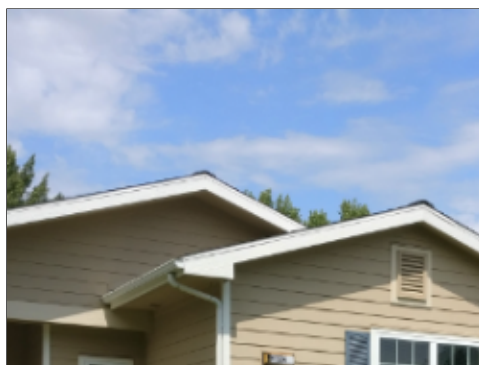



## **D07.1. Roof Type and Form**

1. Use proven, cost-effective roof systems with high durability, weather resistance, and low maintenance that are compatible with Installation Facilities Standards (IFS) and requirements for the designated Facility Group.
2. Generally match the roof type and form of existing adjacent facilities in new construction. Use a combination of gabled and hipped roofs as the primary building form for all facility types. Open gabled elements may be used to accent entries. Gabled end walls may also be used.
3. Flat roofs with continuous parapet walls are discouraged and should be limited to special use facilities when approved by the ACRB.
4. Group 1, 2, and 3 buildings with sloped roofs shall use standing seam metal roofing. 16" wide panels with a 1-1/2" high seam is the standard.
5. Provide screens for roof-mounted appendages and equipment of the same materials, which are used predominantly in the building's roof systems.
6. Roof translucent panels are permitted only for Group 1.
7. Low-sloped roofs are only allowed for larger structures in combination with hipped roofs, or to match existing conditions on renovation / alteration projects.
8. Group 4 facilities shall have gabled or hipped composite shingle roofs.
9. Roof eaves shall extend beyond the exterior wall for roof drainage and shading. Provide overhangs for shading in response to local climatic conditions, sized and proportioned to the height of the facility and to the window openings being shaded.
10. South-facing eaves shall coordinate with adjacent wall-mounted shading devices.
11. The color, shape and slope of the eave and soffit shall be compatible with adjacent facilities.
12. Keep roofs uncluttered and minimize penetrations.
13. Diminish massive roofs into coordinated smaller components consistent with adjacent facilities; avoid random, arbitrary changes.
14. Increase the insulation value of existing roofing systems during renovations if supported by life cycle cost and structural analysis.
15. Roofs shall be maintained for the life of the system and replaced in accordance with UFC 3-110-04 and AFI 32-1051. A warranty is required on all new roofs.
16. Manufacturers listed below are only provided to establish a baseline of equivalency among all applicable manufacturers.

## **D07.2. Roof Slope**

1. Group 1 and 2 buildings shall use sloped roofs, min. 3:12.
2. Low-sloped roofs are allowed for larger structures or to match existing conditions on renovation projects. Minimal-sloped roofs may also be used for Group 3 facilities in high-visibility areas. Membrane roofing for low-sloped roofs may be used only with ACRB approval. A warranted minimum slope of 1/2 : 12 is required. Mill finish may be used on low sloped roofs that are not visible.
3. Group 4 facilities shall use 4:12 to 6:12 roof slopes.
4. Ensure adequate drainage, and connect to the subsurface rain collection system where available.

5. Provide roof slopes to accommodate solar photovoltaic, solar thermal, passive systems and daylighting when applicable following UFC 1-200-02.
6. Provide underlayments as required for the roofing type as directed by the UFC.

### **D07.3. Parapets and Copings**

1. As approved on a case basis, extend wall materials vertically above the roof line and provide metal copings to match the wall. Ensure copings are properly flashed and detailed to avoid roof leaks.
2. Properly proportioned turn-down standing seam metal fascia are permitted with ACRB approval.

### **D07.4. Color and Reflectivity**

1. Standing seam metal roofs in Groups 1 and 2 and smaller facilities in Group 3 shall be weathered copper in color to match adjacent facilities and follow requirements of IFS.
2. All minimal-slope membrane roofs shall use only use high-albedo, high reflectivity color to help decrease the temperature around the buildings and minimize damage to human and wildlife habitat.
3. Sloped roofs in Group 4 shall cover a variety of earth tone browns and grays in color for single family dwellings. Base dormitories shall utilize the weathered copper standing seam metal roofing.
4. Fascia, and soffit finish shall match the roof color when occurring with metal roofing.
5. Stepped flashing at the intersection of roofs and walls shall match roof color.
6. Comply with UFC 3-110-03 and ASHRAE 90.1 for Solar Reflectance Index (SRI) and thermal requirements.
7. All roof flashing shall match the color of the predominant background material.

### **D07.5. Gutters, Downspouts, Scuppers, Drains**

1. All sloped roofs shall use gutters and downspouts. Gutters shall be outside the fascia.
2. Internal roof drainage systems are not permitted in new construction. Minimal-sloped roofs shall be sloped to drain to the building perimeter through scuppers into downspouts.
3. All gutters and fascia shall match the roof color.
4. On painted buildings, paint down to match the wall color.
5. Size the roof drainage system per IBC and SMACNA for the region.
6. Use scuppers as required in parapet walls. Arrange scuppers in an orderly manner consistent with other elements of the wall system.
7. When open scuppers are connected to downspouts, provide transitions consistent with adjacent facilities.
8. Integrate open-face downspouts with the architectural details of the wall system and arrange in an orderly, non-prominent appearance. Generally blend downspouts with the color of the wall (not contrasting it).
9. Fabricate downspouts from non-corrosive materials such as aluminum or zinc-coated steel. Provide powder-coated finishes in medium bronze.
10. Provide angled transitional pieces for downspouts to fit closely against the wall for their entire length.
11. Coordinate locations of downspouts to conceal control joints in masonry walls when possible.

12. Place downspouts away from building entries. Water discharged should not run across sidewalks. Provide concrete splash blocks at grade draining or connected directly to the storm drainage system.

#### **D07.6. Roof Vents and Elements**

1. Minimize and consolidate roof penetrations into a single, inconspicuous point whenever possible.
2. PVC pipes and other utility elements shall be screened or finished to match the roof color.
3. Avoid the use of rooftop mechanical equipment, however for renovations and unavoidable configurations ensure units are screened. Mechanical roof pits are not permitted.
4. Provide access points and service routes to equipment that protect the roof.
5. Screen all large vents. Ridge vents are preferred. Louver grilles at gabled end walls are acceptable.
6. Ensure attic spaces are properly vented at ridges and soffits.
7. Match roof color for all exposed equipment and vents.
8. Avoid roof-mounted antenna systems. Consider the use of dormer vents to conceal and screen exhaust fans. Make mechanical vent sizes and shapes consistent with architectural elements.
9. Arrange Lightning Protection Systems (LPS) components in an ordered, uncluttered, inconspicuous appearance and integrated into the organization of the roof and wall systems.
10. Ensure that LPS roof mounting systems are approved by the roofing manufacturer.
11. Additions to a roof shall not interfere with LPS or other rooftop systems that may be required.
12. Permanent fall protection shall be included with any addition to a roof with a slope above 3:12 per UFC 3-110-03 to a roof with a slope above 3:12 per UFC 3-110-03.

#### **D07.7. Clerestories and Skylights**

1. Clerestories and skylights are permitted in Group 1 facilities. These are allowed in Group 3 facilities only when serving passive systems and are justifiable by life-cycle analysis.
2. Clerestories are preferred to skylights to avoid roof penetrations. Skylights, when permitted, must be simple in shape and integrated with the roof system to eliminate leakage.
3. Design clerestories and skylights using the same principles for seasonal shading that are required for walls and roof overhangs.
4. Translucent panel systems are preferred in clerestory applications due to lack of window cleaning.
5. Clerestories and skylights must comply with UFC 4-10-01.

#### **D07.8. Vegetated Roof**

1. Not applicable.

#### **D07.9. Roof Systems Materials**

**Note:** Apply the below base-wide standards for Roof Systems (products, materials and color). Then refer to the Appendix and apply any additional requirements specifically related to the Facility District in which the project is located.

### D07.9.1. Standing Seam Metal

Applicable  N/A      Number of base standards 1

Image Tool 250 x 188



Type: **Style 1**

Applies to:  Group 1  Group 2  Group 3  Group 4  Other

Mfr: AEP Span

Color: weathered copper

Finish: Kynar 500, Fluoropolymer

Model #: Flat panel, 16" wide, 1 1/2" seam

Other: Shed, gabled or hipped standing seam metal

UGFS: Section 07 61 14 Steel Standing Seam Roofing  
<http://www.wbdg.org/FFC/DOD/UGFS/UGFS 07 61 14.00 20.pdf>

### D07.9.2. Membrane Single-ply

Applicable  N/A

### D07.9.3. Built-up Multi-ply

Applicable  N/A

### D07.9.4. Concrete Tile

Applicable  N/A

### D07.9.5. Clay Tile

Applicable  N/A

### D07.9.6. Slate Shingles

Applicable  N/A

### D07.9.7. Vegetated System

Applicable  N/A

### D07.9.8. Ribbed Metal Sheeting

Applicable  N/A

---

### D07.9.9. Composite Shingles

Applicable  N/A      Number of base standards 1

Image Tool 250 x 188



Type: **Asphalt Shingles**

Applies to:  Group 1  Group 2  Group 3  Group 4  Other

Mfr: PABCO Roof

Color: Earth Tones

Finish: Factory

Model #: Tahoma

Other: Gabled or hipped with transverse gable or hipped features

UFGS: Section 07 31 13 Glass-fiber-reinforced Asphalt Shingles  
<http://www.wbdg.org/FFC/DOD/UFGS/UFGS 07 31 13.pdf>

---

### D07.9.10. Other

Applicable  N/A

---



## D08. STRUCTURAL SYSTEMS

Comply with AF Corporate Standards for Facilities Exteriors:

<http://afcs.wbdg.org/facilities-exterior/index.html>

Comply with AF Corporate Standards for Structural Systems:

<http://afcs.wbdg.org/facilities-exterior/structural-systems/index.html>

Comply with AFCFS Recommended Materials:

<http://afcs.wbdg.org/facilities-exterior/structural-systems/materials/index.html>

*Insert 3 photos for each facility group.*

Image Tool 250 x 188

Group 1

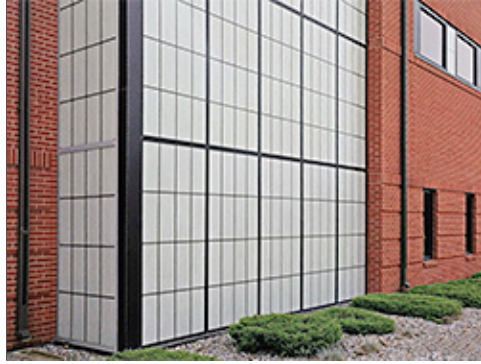

Group 2



Group 3



Group 4



## D08.1. Systems and Layouts

1. Pre-engineered structural steel framing may be used for Groups 1, 2 and 3 facilities; Installation-appropriate thermal envelopes, materials and detailing are required.
2. Select economical structural systems that integrate roof and wall systems. The FAFB BDS provides additional information on accepted structural design approaches.
3. Narrow buildings 60' or less in width with column-free interiors are preferred for office, administrative and personnel spaces; when interior columns are required optimize the structural grid layout for open-plan arrangements.
4. Fully coordinate structural grids with exterior window systems to align columns with window frames or wall systems.
5. When structure is exposed provide an organized appearance and coordinate with mechanical, electrical, plumbing, fire protection, information technology, and communications systems.
6. Limit the use of specialty systems (such as space frames, vaults or domes) and of structure as a visual feature.
7. Cost-effectively design interior bearing walls as thermal mass.

## D08.2. Structural Systems Materials

**Note:** Apply the below base-wide standards for Structural Systems (products, materials and color). Then refer to the Appendix and apply any additional requirements specifically related to the Facility District in which the project is located.

### D08.2.1. Concrete

Applicable  N/A

---

### D08.2.2. Insulated Concrete Forming (ICF)

Applicable  N/A

---



### D08.2.3. Steel

Applicable  N/A

Number of base standards 1

Image Tool 250 x 188



Type: **Rigid Framing**

Applies to:  Group 1  Group 2  Group 3  Group 4  Other

Mfr: US Steel

Color: Shop primed

Finish: Matte

Model #: Structural steel shapes

Other: N/A

UFGS: Section 05 12 00 Structural Steel

<http://www.wbdg.org/FFC/DOD/UFGS/UFGS 05 12 00.pdf>

### D08.2.4. Pre-Engineered Steel

Applicable  N/A

Number of base standards 1

Image Tool 250 x 188



Type: **Moment Frame**

Applies to:  Group 1  Group 2  Group 3  Group 4  Other

Mfr: Behlen Building Systems

Color: Factory primed

Finish: Matte

Model #: Moment Frame

Other: Draped insulation may be used behind wall system;  
Behlen standing seam roof system may be used for Group 3

UFGS: Section 13 12 00 Steel Building Systems

(Not Available on UFGS)

Section 13 34 19 Metal Building Systems

<http://www.wbdg.org/FFC/DOD/UFGS/UFGS 13 34 19.pdf>

### D08.2.5. Masonry

Applicable  N/A

### D08.2.6. Heavy Timber

Applicable  N/A

---

### D08.2.7. Light-gauge Steel

Applicable  N/A

---

### D08.2.8. Lumber Framing

Applicable  N/A      Number of base standards 1

Image Tool 250 x 188



Type: **Lumber Framing**

---

Applies to:  Group 1  Group 2  Group 3  Group 4  Other

Mfr: Boise Cascade Wood Products

---

Color: N/A

---

Finish: S4S

---

Model #: Structural dimensional lumber

---

Other: N/A

---

UFGS: Section 06 10 00 Rough Carpentry  
[http://www.wbdg.org/FFC/DOD/UFGS/UFGS\\_06\\_10\\_00.pdf](http://www.wbdg.org/FFC/DOD/UFGS/UFGS_06_10_00.pdf)  
Section 06 11 00 Wood Framing and Sheathing  
(Not Available on UFGS)

---

### D08.2.9. Other

Applicable  N/A

---



## D09. MECHANICAL, ELECTRICAL AND PLUMBING

Comply with AF Corporate Standards for Facilities Exteriors:

<http://afcs.wbdg.org/facilities-exterior/index.html>

Comply with AF Corporate Standards for Mechanical, Electrical and Plumbing:

<http://afcs.wbdg.org/facilities-exterior/mechanical-electrical-and-plumbing/index.html>

*Insert 3 photos for each facility group.*

Image Tool 250 x 188

Group 1



Group 2



Group 3



Group 4





### **D09.1. Passive and Active Systems**

1. Fully integrate passive heating and cooling systems into facility designs whenever practical for the local climate prior to the design of active mechanical systems.
2. Provide optimized passive and active systems; design active mechanical systems to supplement thermal mass walls and floors.
3. Develop renewable energy systems including geo-exchange (ground source heat pumps) when life cycle cost effective.
4. Performance display screens, which report energy performance and utility savings, are encouraged; when provided locate these in building lobbies or common areas.
5. Solar domestic hot water systems are required when life cycle cost effective for the climate.
6. Integrate shading into building exteriors to reduce solar heat gain during hot seasons.

### **D09.2. Functionality and Efficiency**

1. Fully coordinate mechanical, electrical, plumbing (MEP) and fire protection systems with each other and with the building structure, enclosure, thermal envelope and interior design.
2. Ensure direct exterior access is provided (for CE) to main mechanical and electrical rooms.
3. Screen exterior equipment from primary views (landscape, building masses, screen walls) and comply with ATEP requirements.
4. Keep equipment away from main building entrances; locate service area/yard on least visible side of a building.
5. Coordinate the location of all exterior meters, equipment and devices to provide convenient access and an overall coordinated and orderly appearance.
6. Design emergency generator systems integrally with all other building systems and avoid incompatible building additions; locate generators near service areas and ensure they are not visible from primary entrances.
7. When structure is exposed as a finished ceiling, fully integrate MEP and fire protection systems to provide an organized uncluttered appearance.
8. Conceal ducts, piping, conduits, devices, etc., when permanent walls, suspended ceilings or raised floors are provided; locate sprinkler heads in orderly configuration.
9. Limit interior wall-mounted equipment in occupied personnel spaces; avoid surface-mounted conduit and pipes.
10. Provide efficient utility rooms with layouts to facilitate system performance and maintenance; provide convenient access to controls, clearly label systems and include operating and maintenance instructions.
11. Separate mechanical and electrical and communications rooms.
12. Integrate recessed and wall-mounted fixtures such as fire standpipe cabinets and drinking fountains within permanent walls.



## E01. Building Configurations

Comply with Air Force Corporate Standards for Building Configurations:

<http://afcfs.wbdg.org/facilities-interiors/buildings-configurations/index.html>

1. Provide open-plan configurations for office, administrative, operational and related activities and spaces for maximum flexibility. Use a “core and shell” approach in which all building systems, infrastructure and permanent interior partitions anticipate two or more uses (operations) during a facility’s lifespan.
2. Create flexible interior configurations using Furniture, Fixtures & Equipment (FF&E) and limit private offices and private rooms. Refer to AFMAN 32-1084 for space requirements. To the greatest extent, limit permanent partitions to core areas such as toilet rooms, stairs, mechanical and utility rooms.
3. Use more durable long-lasting finishes in core areas for walls, ceilings, floor coverings and built-in casework. Coordinate interior FF&E layouts with structural grids during space planning.
4. Provide high-performance building configurations following UFC 1-200-02. Ensure passive design strategies are cost effectively incorporated before active mechanical systems are designed.
5. Comply with UFC 1-200-01, general building requirements. UFC 1-200-01 provides applicability of model building codes and government unique criteria for typical design disciplines and building systems, as well as for accessibility, antiterrorism, security, high performance and sustainability requirements, and safety.
6. Meet security and force protection requirements in UFC 4-010-01: DoD Minimum Antiterrorism Standards for Buildings.
7. Comply with AFCFS for supporting mission requirements, addressing human comfort and well being, and creating highly flexible interiors while satisfying metrics for high performance and sustainable buildings.
8. Provide a level of quality for interior features, materials and finishes that is appropriate for the Facility Group number. Group 1 may receive higher quality than Groups 2 thru 4. Refer to Facility Hierarchy.
9. Through open-plan configurations, preserve all passive and natural design strategies and fully integrate facility interiors with overall building systems.
10. Professional interior designers, or architects with significant interior design experience, must accomplish the design and review of applicable new construction, renovations and maintenance projects.
11. Consult with the State Historic Preservation Officer (SHPO) and base-level Historic Preservation offices regarding proposed changes to properties listed on or eligible for listing on the National Register of Historic Places. Follow requirements of The National Historic Preservation Act and Secretary of the Interior Standards for the Treatment of Historic Properties.
12. Maintain architectural compatibility following AFCFS and this Installation Facilities Standards (IFS) document to create continuity while avoiding monotony.

### E01.1. Layout and Common Areas

Comply with Air Force Corporate Standards for Layout and Common Areas:

<http://afcfs.wbdg.org/facilities-interiors/buildings-configurations/layout-and-common-areas/index.html>

1. Create open-plan interior environments to accommodate changes.
2. Limit interior partitions, private offices and rooms; use furniture or modular systems to provide privacy and acoustic control.
3. When partitions are functionally justified such as for conference rooms, use systems furniture and moveable (demountable) floor-to-ceiling wall systems for acoustical or visual privacy.
4. Proportion lobbies and common spaces based on type of function, activity and facility group.

5. Allow no direct sight lines into restrooms.
6. Situate utility and core areas to minimize impact on daylighting and to maximize use as thermal buffers.
7. Ensure electrical, lighting and communications system can be adaptable to configuration changes.
8. Avoid power poles to the maximum extent; when poles are necessary minimize the number and coordinate locations with furniture placement and other elements.
9. Avoid sloping floors to maintain flexibility and eliminate future structural changes.
10. Special consideration may apply to Sensitive Compartmented Information Facilities (SCIFs).

### **E01.1.1. Interior Design Process**

Each designer appointed to projects affecting interior environments has the opportunity to propose a materials palette that will effectively activate, and enrich the spaces, either new or existing, that they are upgrading or constructing. The 92 CES will offer guidance on general approaches to interior design, and design proposals will be reviewed on an individual project basis. The FAFB BDS provides additional guidance on the submission of materials boards and samples.

1. Comply with UFC 3-120-10 for the Comprehensive Interior Design (CID,) which includes both Structural Interior Design (SID) and Furniture, Fixtures & Equipment (FF&E) design services.
2. Use a collaborative, integrated planning and design team, composed of user, government support staff, and appropriate professionals. Integrate architectural features using simple detailing to create a professional appearance; avoid extravagant or excessive detailing.
3. Ensure interior designs satisfy the functional requirements within the context of flexibility, sustainability and the building's energy performance.
4. Base space planning on square foot allocations from AFM 32-1084. Identify special requirements if any, such as privacy separation, VIP areas, gathering spaces and storage. Note: The occupant's rank and position will influence the square footage and selection of materials.
5. Provide clear circulation and pathway finding for both horizontal and vertical directions that accommodate the number of personnel in the facility.
6. Maximize efficiencies in the space plan for functional relationships and adjacencies for all facility users. Efficiently create and situate rooms and support rooms such as conference / meeting rooms and break rooms.
7. Provide interior design building-related illustrations, drawings, schedules, materials selections, specifications and cost estimates as listed in UFC 3-120-10. Refer to Furnishings in this IFS also.
8. SID Format shall follow HQ AFCEC standards.
9. Base the FF&E package on the furniture footprint developed in the SID. Identify all new or existing equipment needed and its users within each facility or each area of the facility. Provide specific information on: equipment sizes, electrical requirements, ventilation requirements, weight (if heavy), quantity, and security level if required. Presume all administrative spaces have computers and supporting equipment.

### **E01.1.2. Codes and Regulations**

1. Refer to UFC 1-200-01 for modifications to the International Building Code (IBC) to determine applicable sections of the IBC. Both the IBC Chapter 3 and UFC 3-600-01 govern "Use and Occupancy Classification" for example.
2. Fire code requirements shall be as defined in the International Building Code (IBC) and must be used where dictated by UFC 1-200-01 DoD Building Code (General Building Requirements) except where noted in UFC 3-600-01 (Fire Protection Engineering For Facilities).



3. National Fire Protection Association (NFPA) 101 must be utilized to determine the occupancy classification as it relates to fire/smoke resistance rating of interior non-load bearing partitions (other than occupancy separation), means of egress, interior finish, features of fire protection (including vertical openings) and associated requirements.

## E01.2. Quality and Comfort

Comply with Air Force Corporate Standards for Quality and Comfort:

<http://afcs.wbdg.org/facilities-interiors/buildings-configurations/quality-and-comfort/index.html>

1. Include durability in the life cycle cost analysis for best-value material selections with long life expectancies that do not show excessive wearing.
2. Select long-lasting materials and finishes for permanent core areas such as lobbies, restrooms and stairs.
3. Select low-maintenance materials and products that reduce ongoing servicing and repair and that are easy to clean.
4. Relate the visual quality of finishes to the Facility Group number.
5. Building and interior configurations should address both operations and climatic responses.
6. Convey a professional image; avoid trendy patterns and textures.
7. Use materials and finishes that provide a healthy indoor environment.
8. Orient interior spaces toward views while maintaining cost-effective building performance and efficiency.
9. Promote air movement and daylighting for human health and wellbeing.

## E02. Floors

Comply with Air Force Corporate Standards for Floors:

<http://afcs.wbdg.org/facilities-interiors/floors/index.html>

### E02.1. Floor Materials

**Facility Group 1** floor materials shall be as follows.

Primary: Prepared Slabs (Ground, Polished)

Secondary: Porcelain tile

Tertiary: Carpet, Rubber Stair Treads

**Facility Group 2** floor materials shall be as follows.

Primary: Prepared Slabs (Ground, Polished)

Secondary: Ceramic tile

Tertiary: Carpet, Rubber Stair Treads

**Facility Group 3** floor materials shall be as follows.

Primary: Prepared Slabs (Ground)

Secondary: Prepared Slabs (Sealer)

Tertiary: N/A

**Facility Group 4** floor materials shall be as follows.

Primary: Carpet

Secondary: Ceramic tile

Tertiary: N/A

1. Natural stone and terrazzo flooring may be used in high traffic areas of Group 1 as approved on a case basis.
2. Resilient and rapidly renewable flooring may be used in low traffic areas in Group 1, 2 and 4.



3. Manufacturers listed below are only provided to establish a baseline of equivalency among all applicable manufacturers.

**Note:** Apply the below base-wide standards for Floors (products, materials and color). Then refer to the Appendix and apply any additional requirements specifically related to the Facility District in which the project is located.

### E02.1.1. Prepared Slabs

Applicable  N/A      Number of base standards 2

Image Tool 250 x 188



Type: **Style 1, Ground and Polished**

Applies to:  Group 1  Group 2  Group 3  Group 4  Other

Mfr: Local (TBD)

Color: Natural gray cement, light to dark beige local aggregates

Finish: Fine polished texture

Model #: Medium to small aggregate

Other: N/A

UFGS: Section 03 35 45 Polished Concrete Finishing  
(Not Available on UFGS)

Type: **Style 2, Medium Polished**

Applies to:  Group 1  Group 2  Group 3  Group 4  Other

Mfr: Local (TBD)

Color: Natural gray cement, light to dark beige aggregates

Finish: Medium polished texture, slip resistant

Model #: Medium to small aggregate

Other: N/A

UFGS: Section 03 35 45 Polished Concrete Finishing  
(Not Available on UFGS)



### E02.1.2. Natural Stone and Terrazzo

Applicable  N/A

---

### E02.1.3. Quarry Tile

Applicable  N/A

---

### E02.1.4. Ceramic Tile

Applicable  N/A

Number of base standards 2

Image Tool 250 x 188



Type: **Style 1 Porcelain**

Applies to:  Group 1  Group 2  Group 3  Group 4  Other

Mfr: Daltille

Color: Earth tones

Finish: Matte, slip resistant

Model #: Porcelain tile

Other: Use in high traffic areas. Epoxy grout is recommended.

UFGS: Section 09 30 10 Ceramic, Quarry, and Glass Tiling  
<http://www.wbdg.org/FFC/DOD/UFGS/UFGS 09 30 10.pdf>

Type: **Style 2 Ceramic**

Applies to:  Group 1  Group 2  Group 3  Group 4  Other

Mfr: Daltille

Color: Earth tones

Finish: Matte, slip resistant

Model #: Ceramic tile

Other: Use in low traffic area toilet rooms.

UFGS: Section 09 30 10 Ceramic, Quarry, and Glass Tiling  
<http://www.wbdg.org/FFC/DOD/UFGS/UFGS 09 30 10.pdf>

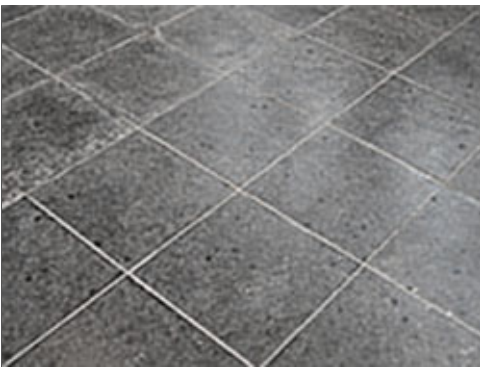

### E02.1.5. Resilient Floor

Applicable  N/A

Number of base standards 1

Image Tool 250 x 188



Type: **Style 1 Stair Treads**

Applies to:  Group 1  Group 2  Group 3  Group 4  Other

Mfr: Roppe

Color: Neutral tones

Finish: Factory

Model #: Raised design rubber tread

Other: Stair treads material

UFGS: Section 09 65 00 Resilient Flooring

<http://www.wbdg.org/FFC/DOD/UFGS/UFGS 09 65 00.pdf>

### E02.1.6. Carpet

Applicable  N/A

Number of base standards 2

Image Tool 250 x 188

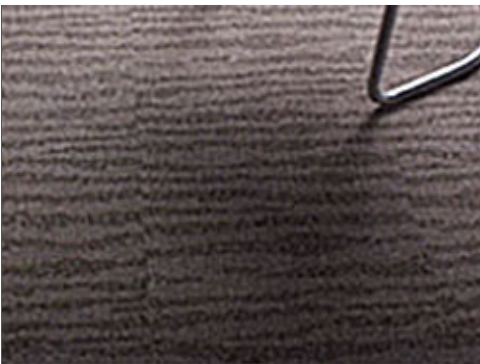

Type: **Style 1**

Applies to:  Group 1  Group 2  Group 3  Group 4  Other

Mfr: Mohawk Group

Color: Neutral multi-colored tones/patterned/solid

Finish: Yarn: Nylon 6 or 6.6/cut pile or loop pile

Model #: Broadloom, 6' wide rolled, carpet tiles, entry walk-off carpet

Other: N/A

UFGS: UFGS 09 68 00 Carpeting

<http://www.wbdg.org/FFC/DOD/UFGS/UFGS 09 68 00.pdf>



Type: **Style 2**

Applies to:  Group 1  Group 2  Group 3  Group 4  Other

Mfr: Mohawk Group

Color: Earth tones

Finish: Factory

Model #: Broadloom, residential loop, "Smartstrand"

Other: N/A

UFGS: UFGS 09 68 00 Carpeting  
<http://www.wbdg.org/FFC/DOD/UFGS/UFGS 09 68 00.pdf>

---

### E02.1.7. Rapidly-Renewable Products

Applicable  N/A

---

### E02.1.8. Other

Applicable  N/A

---

## E03. Walls

Comply with Air Force Corporate Standards for Walls:  
<http://afcs.wbdg.org/facilities-interiors/walls/index.html>

### E03.1. Wall Materials

**Facility Group 1** wall materials shall be as follows.

Primary: Brick (or other as approved by the BCE)

Secondary: Gypsum board (painted)

Tertiary: Ceramic tile (restrooms)

**Facility Group 2** wall materials shall be as follows.

Primary: Brick

Secondary: Gypsum board (painted)

Tertiary: Ceramic tile (restrooms)

**Facility Group 3** wall materials shall be as follows.

Primary: Ground face block, sealed (do not paint)

Secondary: N/A

Tertiary: Ceramic tile (restrooms)

**Facility Group 4** wall materials shall be as follows.

Primary: Gypsum board (painted)

Secondary: N/A

Tertiary: Ceramic tile (restrooms)

1. Follow UFC 3-450-01 (Vibration and Noise Control) for acoustic design issues including speech privacy, sound isolation or sound masking.
2. Select and apply paint with sheens (gloss levels) appropriate for the application following UFGS Section 09 90 00 Paints and Coatings.
3. Provide ceramic tile on wet walls of kitchens, toilet rooms, locker rooms, etc., in all facility groups.
4. Neutral split-face or ground-face integrally colored block with a clear sealer may be used in Group 3. Do not paint block.
5. Provide rubber base on drywall partitions in Groups 1 and 2.
6. Hardwood base may only be used in Group 1 as approved on a case basis.
7. Hardwood chair rails / bumper rails may be used in high-use areas of Groups 1 and 2; aqueous clear finishes are preferred to reduce maintenance; plastic chair rails are permitted only in medical applications.
8. Decorative moldings may be used only in Group 1 when approved on a case basis.
9. Corner guards are permitted only in high traffic spaces with wheeled or cart use such as private service areas in Groups 1 and 2; stainless steel corners guards with a brushed finish may be judiciously used in Group 3.
10. Group 4 may use painted composite wood base.
11. Manufacturers listed below are only provided to establish a baseline of equivalency among all applicable manufacturers.

**Note:** Apply the below base-wide standards for Walls (products, materials and color). Then refer to the Appendix and apply any additional requirements specifically related to the Facility District in which the project is located.

### **E03.1.1. Concrete**

Applicable  N/A

---



### E03.1.2. Masonry

Applicable  N/A

Number of base standards 1

Image Tool 250 x 188



Type: **Modular Face Brick**

Applies to:  Group 1  Group 2  Group 3  Group 4  Other

Mfr: Local (TBD)

Color: Red or brown blend (match exterior)

Finish: Light texture

Model #: Coursed unit masonry

Other: Brick is preferred. Concrete block may only be used in Group 3 when approved by the BCE.

UFGS: Section 03 33 00 Cast-In-Place Architectural Concrete  
<http://www.wbdg.org/FFC/DOD/UFGS/UFGS 03 33 00.pdf>

### E03.1.3. Ceramic Tile

Applicable  N/A

Number of base standards 1

Image Tool 250 x 188

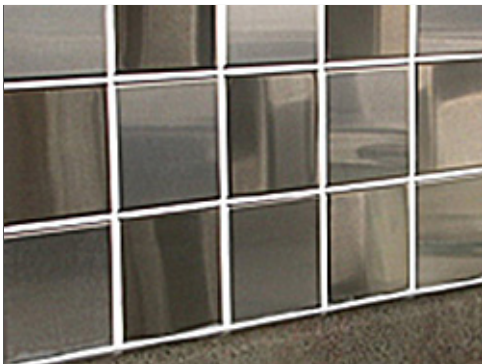

Type: **Style 1**

Applies to:  Group 1  Group 2  Group 3  Group 4  Other

Mfr: Daltile

Color: Earth tones

Finish: Gloss, Semi-gloss

Model #: Ceramic wall tile

Other: Located on wet walls in restrooms

UFGS: Section 09 30 10 Ceramic, Quarry, and Glass Tiling  
<http://www.wbdg.org/FFC/DOD/UFGS/UFGS 09 30 10.pdf>

### E03.1.4. Gypsum Board

Applicable  N/A

Number of base standards 1

Image Tool 250 x 188



Type: **Style 1**

Applies to:  Group 1  Group 2  Group 3  Group 4  Other

Mfr: US Gypsum

Color: Solid Earth tone colors

Finish: Paint (Sheen per UFGS)

Model #: Tapered edge

Other: N/A

UFGS: Section 09 29 00 Gypsum Board

<http://www.wbdg.org/FFC/DOD/UFGS/UFGS 09 29 00.pdf>

Section 09 90 00 Paints and Coatings

<http://www.wbdg.org/FFC/DOD/UFGS/UFGS 09 90 00.pdf>

### E03.1.5. Metal Panels

Applicable  N/A

### E03.1.6. Wood Paneling

Applicable  N/A

### E03.1.7. Rapidly-Renewable Products

Applicable  N/A

### E03.1.8. Other

Applicable  N/A

## E04. Ceilings

Comply with Air Force Corporate Standards for Ceilings:

<http://afcfs.wbdg.org/facilities-interiors/ceilings/index.html>

### E04.1. Ceiling Materials

**Facility Group 1** ceiling materials shall be as follows.

- Primary: Exposed Framing (Roof / Floor Structure Above)
- Secondary: Grid and Acoustical Tile
- Tertiary: Gypsum board (painted)

**Facility Group 3** ceiling materials shall be as follows.

- Primary: Exposed Framing (Roof / Floor Structure Above)
- Secondary: Exposed Framing (Roof / Floor Structure Above)
- Tertiary: Gypsum board (painted)

**Facility Group 2** ceiling materials shall be as follows.

- Primary: Exposed Framing (Roof / Floor Structure Above)
- Secondary: Grid and Acoustical Tile
- Tertiary: Gypsum board (painted)

**Facility Group 4** ceiling materials shall be as follows.

- Primary: Gypsum board (painted)
- Secondary: N/A
- Tertiary: N/A

1. Accent ceiling materials such as metal, wood, and rapidly renewable may be used in Group 1 as approved on a case basis.
2. Follow UFC 3-450-01 (Vibration and Noise Control) for acoustic design issues including speech privacy, sound isolation or sound masking.
3. Manufacturers listed below are only provided to establish a baseline of equivalency among all applicable manufacturers.

**Note:** Apply the below *base-wide standards* for Ceilings (products, materials and color). Then refer to the Appendix and apply any additional requirements specifically related to the Facility District in which the project is located.

### E04.1.1. Exposed Framing (Roof / Floor Structure Above)

Applicable  N/A      Number of base standards 1

Image Tool 250 x 188



Type: **Style 1**

Applies to:  Group 1  Group 2  Group 3  Group 4  Other

Mfr: Vulcraft

Color: Neutral colors reviewed on a case basis

Finish: Field painted (Sheen per UFGS)

Model #: Formlok floor and roof decking

Other: N/A

UFGS: Section 05 30 00 Steel Decks  
[http://www.wbdg.org/FFC/DOD/UFGS/UFGS\\_05\\_30\\_00.pdf](http://www.wbdg.org/FFC/DOD/UFGS/UFGS_05_30_00.pdf)

### E04.1.2. Exposed Concrete

Applicable  N/A

### E04.1.3. Grid and Acoustical Tile

Applicable  N/A Number of base standards 1

Image Tool 250 x 188



Type: **Style 1**

Applies to:  Group 1  Group 2  Group 3  Group 4  Other

Mfr: Armstrong

Color: White

Finish: Factory

Model #: 2'x2' Tegular with reveal edge and fine texture, grid 15/16"

Other: Performance characteristics are Class A; NRC-0.70; CAC-40; LR-0.86; minimum recycled content 82%.

UFGS: Section 09 51 00 Acoustical Ceilings  
<http://www.wbdg.org/FFC/DOD/UFGS/UFGS 09 51 00.pdf>

### E04.1.4. Gypsum Board

Applicable  N/A Number of base standards 1

Image Tool 250 x 188



Type: **Style 1**

Applies to:  Group 1  Group 2  Group 3  Group 4  Other

Mfr: US Gypsum

Color: Solid neutral colors

Finish: Paint (sheen per UFGS)

Model #: Tapered edge

Other: N/A

UFGS: Section 09 29 00 Gypsum Board  
<http://www.wbdg.org/FFC/DOD/UFGS/UFGS 09 29 00.pdf>  
Section 09 90 00 Paints and Coatings  
<http://www.wbdg.org/FFC/DOD/UFGS/UFGS 09 90 00.pdf>

#### **E04.1.5. Metal Panels**

Applicable  N/A

---

#### **E04.1.6. Wood**

Applicable  N/A

---

#### **E04.1.7. Rapidly-Renewable Products**

Applicable  N/A

---

#### **E04.1.8. Other**

Applicable  N/A

---

### **E05. Doors and Windows**

Comply with Air Force Corporate Standards for Doors and Windows:

<http://afcs.wbdg.org/facilities-interiors/doors-and-windows/index.html>

#### **E05.1. Doors and Windows and Frames Materials**



**Facility Group 1**

door (frame) and window frame materials shall be as follows.

Primary: Aluminum, clear anodized

Secondary: Hollow metal (painted)

Tertiary: N/A

**Facility Group 1**

door (leaf) materials shall be as follows.

Primary: Hardwood veneer

Secondary: Hollow metal (painted)

Tertiary: N/A

**Facility Group 2**

door (frame) and window frame materials shall be as follows.

Primary: Aluminum, clear anodized

Secondary: Hollow metal (painted)

Tertiary: N/A

**Facility Group 2**

door (leaf) materials shall be as follows.

Primary: Hardwood veneer

Secondary: Hollow metal (painted)

Tertiary: N/A

**Facility Group 3**

door (frame) and window frame materials shall be as follows.

Primary: Hollow metal (galvanized, painted)

Secondary: Hollow metal (galvanized, painted)

Tertiary: N/A

**Facility Group 3**

door (leaf) materials shall be as follows.

Primary: Hollow metal (galvanized, painted)

Secondary: Hollow metal (galvanized, painted)

Tertiary: N/A

**Facility Group 4**

door (frame) and window frame materials shall be as follows.

Primary: Wood

Secondary: N/A

Tertiary: N/A

**Facility Group 4**

door (leaf) materials shall be as follows.

Primary: Wood solid core

Secondary: Composite solid core

Tertiary: N/A

1. Hardwood casings may be provided over metal frames in Group 1 as approved on a case basis.
2. Paneled textured doors are preferred in Group 4.
3. Do not use hollow-core wood doors.
4. Generally match original hardware in renovations.
5. Manufacturers listed below are only provided to establish a baseline of equivalency among all applicable manufacturers.

**Note:** Apply the below base-wide standards for Doors and Windows (products, materials and color). Then refer to the Appendix and apply any additional requirements specifically related to the Facility District in which the project is located.

### E05.1.1. Aluminum

Applicable  N/A

Number of base standards 1

Image Tool 250 x 188



Type: **Style 1**

Applies to:  Group 1  Group 2  Group 3  Group 4  Other

Mfr: Kawneer

Color: Clear anodized

Finish: Factory

Model #: InFrame Interior Framing, (2x4 nominal framing)

Other: Satin stainless steel hardware

UFGS: Section 08 41 13 Aluminum-Framed Entrances and Storefronts  
<http://www.wbdg.org/FFC/DOD/UFGS/UFGS 08 41 13.pdf>  
Section 08 71 00 Door Hardware  
<https://www.wbdg.org/FFC/DOD/UFGS/UFGS 08 71 00.pdf>

### E05.1.2. Hollow Metal

Applicable  N/A

Number of base standards 2

Image Tool 250 x 188



Type: **Steel Doors**

Applies to:  Group 1  Group 2  Group 3  Group 4  Other

Mfr: Steelcraft

Color: Neutral colors

Finish: Paint (Sheen per UFGS)

Model #: Hollow metal, 2" w. frames, 16 gauge (welded corners) grouted solid

Other: Provide in Group 3 and in utility areas of Group 1 and 2. Provide A25 "galvannealed" coating. All interior steel doors shall have a factory applied primer finish. Provide satin stainless steel hardware.

UFGS: Section 08 11 13 Steel Doors and Frames  
<http://www.wbdg.org/FFC/DOD/UFGS/UFGS 08 11 13.pdf>  
Section 08 71 00 Door Hardware  
<https://www.wbdg.org/FFC/DOD/UFGS/UFGS 08 71 00.pdf>

Type: **Steel Frames**

Applies to:  Group 1  Group 2  Group 3  Group 4  Other

Mfr: Steelcraft

Color: Neutral colors

Finish: Paint (Sheen per UFGS)

Model #: Hollow metal, frame grouted solid

Other: Satin stainless steel hardware

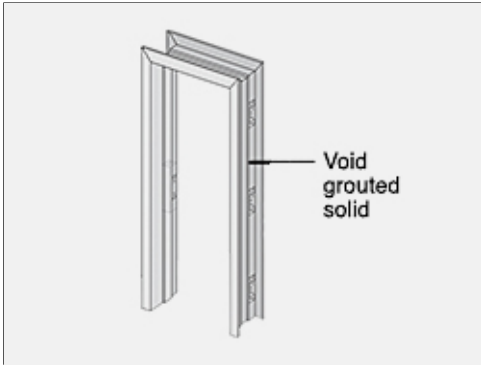

UFGS: Section 08 11 13 Steel Doors and Frames  
<http://www.wbdg.org/FFC/DOD/UFGS/UFGS 08 11 13.pdf>  
Section 08 71 00 Door Hardware  
<https://www.wbdg.org/FFC/DOD/UFGS/UFGS 08 71 00.pdf>

### E05.1.3. Wood

Applicable  N/A

Number of base standards 2

Image Tool 250 x 188

Type: **Style 1, Administrative**

Applies to:  Group 1  Group 2  Group 3  Group 4  Other

Mfr: Simpson

Color: Natural hardwood veneer

Finish: Clear Sealer, satin (aqueous)

Model #: 3'x7'x 1 3/4", solid core

Other: Satin stainless steel hardware, Glass lites may be used. Stained birch veneer face, 5 ply construction, rotary cut finish.



UFGS: Section 08 14 00 Wood Doors  
<http://www.wbdg.org/FFC/DOD/UFGS/UFGS 08 14 00.pdf>  
Section 08 71 00 Door Hardware  
<https://www.wbdg.org/FFC/DOD/UFGS/UFGS 08 71 00.pdf>

Type: **Style 2, Residential**

---

Applies to:  Group 1  Group 2  Group 3  Group 4  Other

Mfr: Simpson

---

Color: Natural hardwood veneer or paint grade

---

Finish: Clear Sealer or paint, satin (aqueous)

---

Model #: Full slab or panels

---

Other: Satin nickel hardware

---

UFGS: Section 08 14 00 Wood Doors

<http://www.wbdg.org/FFC/DOD/UFGS/UFGS 08 14 00.pdf>

Section 08 71 00 Door Hardware

<https://www.wbdg.org/FFC/DOD/UFGS/UFGS 08 71 00.pdf>

---

#### E05.1.4. Other

Applicable  N/A

---

### E06. Casework Systems

Comply with Air Force Corporate Standards for Casework Systems:

<http://afcs.wbdg.org/facilities-interiors/casework-systems/index.html>

#### E06.1. Casework Materials

1. Select casework systems and materials considering durability, maintenance requirements and LCCA.
2. Natural stone and cast stone countertops may only be used in Group 1 with approval on a case basis.
3. Metal cabinets and countertops shall be provided in heavy-use operations and in Group 3.
4. Refer to AFCFS for approved materials.
5. Manufacturers listed below are only provided to establish a baseline of equivalency among all applicable manufacturers.

### E06.1.1. Plastic Laminate

Applicable  N/A

Number of base standards 1

Image Tool 250 x 188



Type: **Style 1, Low Use Areas**

Applies to:  Group 1  Group 2  Group 3  Group 4  Other

Mfr: Formica

Color: Medium Earth tones and neutral tones

Finish: Light textured

Model #: High pressure laminate

Other: Combine with matching solid-surface banding on casework edges. Plastic laminate countertops shall be avoided in areas prone to standing water.

UFGS: Section 06 41 16.00 10 Plastic-Laminate-Clad Architectural Cabinets  
[http://www.wbdg.org/FFC/DOD/UFGS/UFGS\\_06\\_41\\_16.00\\_10.pdf](http://www.wbdg.org/FFC/DOD/UFGS/UFGS_06_41_16.00_10.pdf)

### E06.1.2. Solid Polymer Surface

Applicable  N/A

Number of base standards 1

Image Tool 250 x 188



Type: **Style 1, High Use Areas**

Applies to:  Group 1  Group 2  Group 3  Group 4  Other

Mfr: Corian

Color: Medium Earth tones and neutral tones

Finish: Light textured

Model #: Solid Surface

Other: Faces and edge banding

UFGS: Section 12 36 00 Countertops  
[http://www.wbdg.org/FFC/DOD/UFGS/UFGS\\_12\\_36\\_00.pdf](http://www.wbdg.org/FFC/DOD/UFGS/UFGS_12_36_00.pdf)



### E06.1.3. Rapidly-Renewable Products

Applicable  N/A

Number of base standards 1

Image Tool 250 x 188



Type: **Style 1 Moderate Use Areas**

Applies to:  Group 1  Group 2  Group 3  Group 4  Other

Mfr: Plyboo

Color: Natural or amber

Finish: Satin

Model #: Flat grain bamboo plywood

Other: FSC® Certified 100%.

UFGS: Section 12 32 00 Manufactured Wood Casework  
<http://www.wbdg.org/FFC/DOD/UFGS/UFGS 12 32 00.pdf>

### E06.1.4. Metal

Applicable  N/A

Number of base standards 1

Image Tool 250 x 188



Type: **Style 1**

Applies to:  Group 1  Group 2  Group 3  Group 4  Other

Mfr: Steel Sentry

Color: Natural stainless steel or neural colors (steel)

Finish: Mill (stainless) or Powder coated (steel)

Model #: Lab, workbench, computer workstation

Other: Provide highly durable fabrications and finishes in Group 3 which are subjected to heavy use.

UFGS: Section 12 31 00 Manufactured Metal Casework  
<http://www.wbdg.org/FFC/DOD/UFGS/UFGS 12 31 00.pdf>

### E06.2. Countertop Materials

### E06.2.1. Plastic Laminate

Applicable  N/A

Number of base standards 1

Image Tool 250 x 188



Type: **Style 1, Low Use Areas**

Applies to:  Group 1  Group 2  Group 3  Group 4  Other

Mfr: Formica

Color: Medium Earth tones and neutral tones

Finish: Light textured

Model #: High pressure laminate

Other: Only use rounded half or full bullnose and integral backsplash. Do not use plastic laminate edge banding on front edges.

UFGS: Section 06 41 16.00 10 Plastic-Laminate-Clad Architectural Cabinets  
[http://www.wbdg.org/FFC/DOD/UFGS/UFGS\\_06\\_41\\_16.00\\_10.pdf](http://www.wbdg.org/FFC/DOD/UFGS/UFGS_06_41_16.00_10.pdf)

### E06.2.2. Solid Polymer Surface

Applicable  N/A

Number of base standards 1

Image Tool 250 x 188



Type: **Style 1, High Use Areas**

Applies to:  Group 1  Group 2  Group 3  Group 4  Other

Mfr: Corian

Color: Medium Earth tones and neutral tones

Finish: Light textured

Model #: Solid Surface

Other: Faces and edges

UFGS: Section 12 36 00 Countertops  
[http://www.wbdg.org/FFC/DOD/UFGS/UFGS\\_12\\_36\\_00.pdf](http://www.wbdg.org/FFC/DOD/UFGS/UFGS_12_36_00.pdf)

### E06.2.3. Natural Stone

Applicable  N/A

Number of base standards 1

Image Tool 250 x 188



Type: **Style 1, Group 1 High Visibility, Heavy Use**

Applies to:  Group 1  Group 2  Group 3  Group 4  Other

Mfr: Local (TBD)

Color: Neutral tones

Finish: High polish, sealer

Model #: Custom cut slabs

Other: N/A

UFGS: Section 12 36 00 Countertops

<http://www.wbdg.org/FFC/DOD/UFGS/UFGS 12 36 00.pdf>

### E06.2.4. Cast Stone

Applicable  N/A

Number of base standards 1

Image Tool 250 x 188

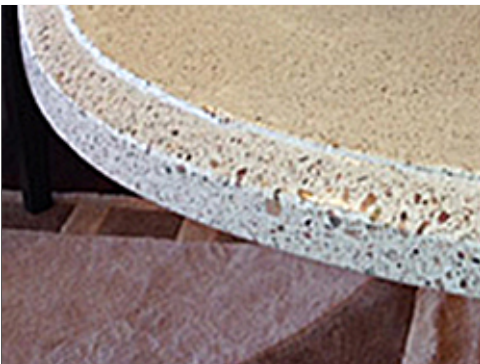

Type: **Style 1, Group 1 High Visibility, Heavy Use**

Applies to:  Group 1  Group 2  Group 3  Group 4  Other

Mfr: Local (TBD)

Color: Neutral tones

Finish: High polish, sealer

Model #: Custom cast or cut slabs

Other: N/A

UFGS: Section 12 36 00 Countertops

<http://www.wbdg.org/FFC/DOD/UFGS/UFGS 12 36 00.pdf>

## E06.2.5. Metal

Applicable  N/A

Number of base standards 1

Image Tool 250 x 188

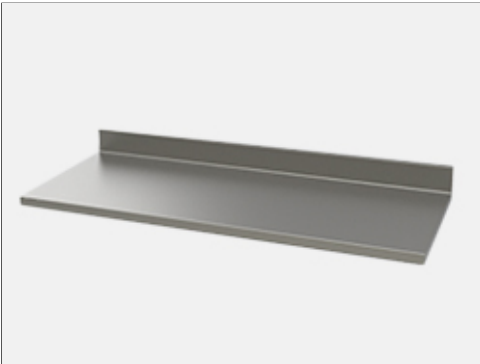

Type: \_\_\_\_\_

Applies to:  Group 1  Group 2  Group 3  Group 4  Other

Mfr: Local (TBD)

Color: Natural stainless steel

Finish: Mill

Model #: Custom fabricated countertops

Other: Provide integral fronts, sides and backsplash

UFGS: Section 12 31 00 Manufactured Metal Casework  
<http://www.wbdg.org/FFC/DOD/UFGS/UFGS 12 31 00.pdf>

## E07. Furnishings

Comply with Air Force Corporate Standards for Furnishings:  
<http://afcs.wbdg.org/facilities-interiors/furnishings/index.html>

### E07.1. Durability and Serviceability

Comply with AF Corporate Standards for Durability and Serviceability:  
<http://afcs.wbdg.org/facilities-interiors/furnishings/durability-and-serviceability/index.html>

### E07.2. Accessories

Comply with AF Corporate Standards for Accessories:  
<http://afcs.wbdg.org/facilities-interiors/furnishings/accessories/index.html>

## E08. Interior Signs

Comply with Air Force Corporate Standards for Interior Signs:  
<http://afcs.wbdg.org/facilities-interiors/interior-signs/index.html>

### E08.1 Types and Color

Comply with Air Force Corporate Standards for Types and Color:  
<http://afcs.wbdg.org/facilities-interiors/interior-signs/types-and-color/index.html>

### E08.2. Interior Signs Materials

1. Natural stone, masonry and cast stone signs may only be used in Group 1 with approval on a case basis.

## E09. Lighting, Power and Communication

### **E09.1. Functionality and Efficiency**

Comply with Air Force Corporate Standards for Functionality and Efficiency:

<http://afcs.wbdg.org/facilities-interiors/lighting-power-and-communication/functionality-and-efficiency/index.html>

### **E09.2. Types and Color**

Proposals shall be provided for review and approval on a case by case basis.



## F. APPENDIX - Facility Districts

- Applicable
- N/A

## G. APPENDIX - References

Comply with Air Force Corporate Standards:  
<http://afcs.wbdg.org/index.html>