

(PRE-FINAL) BUCKLEY AIR FORCE BASE INSTALLATION FACILITIES STANDARDS (IFS)



Installation Elements



Site Development



Facilities Exteriors



Facilities Interiors

APPROVED FOR PUBLIC RELEASE; DISTRIBUTION UNLIMITED

Signature Field

Buckley Air Force Base IFS

Table of Contents

A. OVERVIEW	5	B03.2.3. Preserves	
A01. Facility Hierarchy	6	B03.2.4. Perimeter Fence	
A02. Facility Quality	6	C. SITE DEVELOPMENT	43
A03. Facility Districts	6	C01. Site Design	43
B. INSTALLATION ELEMENTS	8	C01.1. Site Design Considerations	43
B01. Comprehensive Planning	8	C01.2. Building Orientation	45
B01.1. Installation Development Plan (IDP)	8	C02. Utilities	46
B01.1.1. IFS Component Plan of IDP		C02.1. Utility Components.....	47
B01.1.2. Brief History of Base		C03. Parking Areas	51
B01.1.3. Future Development		C03.1. Configurations and Design	52
B02. Street Envelope Standards	15	C03.1.1. Paving and Striping	
B02.1. Hierarchy of Streets	15	C03.1.2. Curbing	
B02.1.1. Arterial Streets		C03.1.3. Internal Islands and Medians	
B02.1.2. Collector Streets		C03.2. Parking Structures	58
B02.1.3. Local Streets		C03.3. Connectivity	59
B02.1.4. Special Routes		C04. Stormwater Management	59
B02.2. Hierarchy of Intersections	26	C04.1. Stormwater Requirements	59
B02.2.1. Arterials		C05. Sidewalks, Bikeways and Trails	61
B02.2.2. Arterial/Collector		C05.1. Circulation and Paving	61
B02.2.3. Collectors		C05.1.1. Ramps and Stairs	
B02.2.4. Special Intersections		C05.1.2. Lighting	
B02.2.5. Street Frontage Requirements		C06. Landscape	63
B02.2.6. Sight Lines		C06.1. Climate-based Materials	64
B02.3. Street Elements	34	C06.1.1. Landscape Design Concept	
B02.3.1. Paving		C06.1.2. Xeriscape Design Principles	
B02.3.2. Curb and Gutter		C06.1.3. Minimizing Water Requirements	
B02.3.3. Utility Service Elements		C06.1.4. Plant Material Selection	
B02.3.4. Traffic Signs		C06.1.5. Water Budgeting (Hydrozones)	
B02.3.5. Street Lighting		C06.1.6. Base Entrance Landscaping	
B02.3.6. Other		C06.1.7. Streetscape Landscaping	
B03. Open Space / Public Space	36	C06.1.8. Pedestrian Circulation Landscaping	
B03.1. Plazas, Monuments and Static Displays	37	C06.1.9. Parking Lot Landscaping	
B03.1.1. Paved Plazas		C06.1.10. Screen/Accent Landscaping	
B03.1.2. Sculptures, Markers and Statuary		C06.1.11. Other	
B03.1.3. Static Display of Aircraft		C07. Site Furnishings	78
B03.2. Grounds and Perimeters	38	C07.1. Furnishings and Elements	78
B03.2.1. Parade Grounds			
B03.2.2. Parks			

Table of contents continued

C07.2. Site Furnishings Products, Materials / Color ..	80	D03.3.4. Thermal Shading	
C07.2.1. Barbeque Grills		D03.3.5. Renewable Heating/Cooling	
C07.2.2. Benches		D03.3.6. Solar Photovoltaic System	
C07.2.3. Bike Racks		D03.3.7. Solar Thermal System	
C07.2.4. Bike Lockers		D04. Building Entrances	116
C07.2.5. Bollards		D04.1. Primary Entrances	117
C07.2.6. Bus Shelters		D04.2. Secondary Entrances	117
C07.2.7. Drinking Fountains		D05. Wall Systems	119
C07.2.8. Dumpster Enclosures / Gates		D05.1. Hierarchy of Materials	120
C07.2.9. Fencing		D05.2. Layout, Organization and Durability	120
C07.2.10. Flagpoles		D05.3. Equipment, Vents and Devices	120
C07.2.11. Lighting – Landscape / Accent		D05.4 Wall Systems Materials	121
C07.2.12. Litter and Ash Receptacles		D05.4.1. Flat Metal Panels	
C07.2.13. Picnic Tables		D05.4.2. Brick Veneer	
C07.2.14. Planters – Free Standing		D05.4.3. Architectural Precast	
C07.2.15. Play Equipment		D05.4.4. Stucco Over Sheathing	
C07.2.16. Screen Walls		D05.4.5. Curtain Wall	
C07.2.17. Tree Grates		D05.4.6. Cast-in Place Concrete	
C07.2.18. Other		D05.4.7. Tilt-up Concrete	
C08. Exterior Signs	94	D05.4.8. Ribbed Metal Sheeting	
C08.1. Colors and Types	94	D05.4.9. EIFS	
C08.1.1. Materials and Color Specifications		D05.4.10.GFRC	
C08.1.2. Installation and Gate Identification Signs		D05.4.11.Concrete Block	
C08.1.3. Building Identification Signs		D05.4.12. Fiber Cement Siding	
C08.1.4. Traffic Control Devices (Street Signs)		D05.4.13. Other	
C08.1.5. Directional and Wayfinding Signs		D06. Doors and Windows	127
C08.1.6. Informational Signs		D06.1. Types	128
C08.1.7. Motivational Signs		D06.2. Layout and Geometry	128
C08.1.8. Parking Lot Signs		D06.3. Glazing and Shading	128
C08.1.9. Regulatory Signs		D06.4. Hardware	129
C08.1.10. Other		D06.5. Doors and Windows Materials	129
C09. Lighting	103	D06.5.1. Anodized Aluminum	
C09.1. Fixtures and Lamping	103	D06.5.2. Hollow Metal	
C09.2. Light Fixture Types	104	D06.5.3. Aluminum-clad Wood	
C09.2.1. Street Lighting		D06.5.4. Other	
C09.2.2. Parking Lot Lighting		D07. Roof Systems	131
C09.2.3. Lighted Bollards		D07.1. Roof Type and Form	132
C09.2.4. Sidewalk Lighting		D07.2. Roof Slope	132
C09.2.5. Walls / Stairs Lighting		D07.3. Parapets and Copings	133
C09.2.6. Other		D07.4. Color and Reflectivity	133
D. FACILITIES EXTERIORS	109	D07.5. Gutters, Downspouts, Scuppers, Drains	133
D01. Supporting the Mission	109	D07.6. Roof Vents and Elements	133
D02. Sustainability	109	D07.7. Clerestories and Skylights	134
D03. Architectural Features	110	D07.8. Vegetated Roof	134
D03.1. Orientation, Massing and Scale	111		
D03.2. Architectural Character	111		
D03.3. Details and Color	111		
D03.3.1. Climate-based Data			
D03.3.2. Natural Ventilation System			
D03.3.3. Thermal Mass			

Table of contents continued

D07.9. Roof Systems Materials	134	E04. Ceilings	155
D07.9.1. Standing Seam Metal		E04.1. Ceiling Materials	155
D07.9.2. Membrane Single-ply		E04.1.1. Exposed Framing (Roof / Floor Structure	
D07.9.3. Built-up Multi-ply		Above)	
D07.9.4. Concrete Tile		E04.1.2. Exposed Concrete	
D07.9.5. Clay Tile		E04.1.3. Grid and Acoustical Tile	
D07.9.6. Slate Shingles		E04.1.4. Gypsum Board	
D07.9.7. Vegetated System		E04.1.5. Metal Panels	
D07.9.8. Ribbed Metal Sheeting		E04.1.6. Wood	
D07.9.9. Composite Shingles		E04.1.7. Rapidly-Renewable Products	
D07.9.10. Other		E04.1.8. Other	
D08. Structural Systems	138	E05. Doors and Windows	158
D08.1. Systems and Layouts	139	E05.1. Doors and Windows and Frames Materials	158
D08.2. Structural Systems Materials	139	E05.1.1. Aluminum	
D08.2.1. Concrete		E05.1.2. Hollow Metal	
D08.2.2. Insulated Concrete Forming (ICF)		E05.1.3. Wood	
D08.2.3. Steel		E05.1.4. Other	
D08.2.4. Pre-Engineered Steel		E06. Casework Systems	162
D08.2.5. Masonry		E06.1. Casework Materials	162
D08.2.6. Heavy Timber		E06.1.1. Plastic Laminate	
D08.2.7. Light-gauge Steel		E06.1.2. Solid Polymer Surface	
D08.2.8. Lumber Framing		E06.1.3. Rapidly-Renewable Products	
D08.2.9. Other		E06.1.4. Metal	
D09. Mechanical, Electrical and Plumbing	143	E06.1.5 Other	
D09.1. Passive and Active Systems	144	E06.2. Countertop Materials	165
D09.2. Functionality and Efficiency	144	E06.2.1. Plastic Laminate	
E. FACILITIES INTERIORS	145	E06.2.2. Solid Polymer Surface	
E01. Building Configurations	146	E06.2.3. Natural Stone	
E01.1. Layout and Common Areas	146	E06.2.4. Cast Stone	
E01.1.1. Interior Design Process		E06.2.5. Metal	
E01.1.2. Codes and Regulations		E06.2.6 Other	
E01.2. Quality and Comfort	147	E07. Furnishings	167
E02. Floors	148	E07.1. Durability and Serviceability	167
E02.1. Floor Materials	148	E07.2. Accessories	167
E02.1.1. Prepared Slabs		E08. Interior Signs	167
E02.1.2. Natural Stone and Terrazzo		E08.1 Types and Color	167
E02.1.3. Quarry Tile		E08.2. Interior Signs Materials	168
E02.1.4. Ceramic Tile		E09. Lighting, Power and Communication	168
E02.1.5. Resilient Floor		E09.1. Functionality and Efficiency	168
E02.1.6. Carpet		E09.2. Types and Color	168
E02.1.7. Rapidly-Renewable Products		F. Appendices	169
E02.1.8. Other		G. Appendices	169
E03. Walls	153		
E03.1. Wall Materials	153		
E03.1.1. Concrete			
E03.1.2. Masonry			
E03.1.3. Ceramic Tile			
E03.1.4. Gypsum Board			
E03.1.5. Metal Panels			
E03.1.6. Wood Paneling			
E03.1.7. Rapidly-Renewable Products			
E03.1.8. Other			

A. OVERVIEW

Comply with Air Force Corporate Standards for Overview:

<http://afcfs.wbdg.org/index.html>

This Installation Facilities Standards (IFS) document is part of the Air Force Corporate Facilities Standards (AFCFS) program to assist bases in implementing and maintaining facilities standards as appropriate for efficient operations within the respective climate region. IFS fully replaces, consolidates and simplifies existing facilities standards documents, such as the Architectural Compatibility Plan (ACP) or ACGs, FEPs, etc., and organizes information using the same structure, or Table of Contents, as the AFCFS website.

IFS reflects the AFCFS' concepts of "Facility Hierarchy" (categorizing facilities into group numbers) and "Facility Quality" (assigning an appropriate level of quality to each group number) and applies these principles at the base level. Applicable DoD and Air Force criteria such as UFCs, AFIs, Memoranda, and UFGSs (Guide Specs) are referenced and linked within IFS to ensure the document is always current.

Navigating within this IFS is efficient and straightforward. Please use the interactive Table of Contents to locate subject matter, and click on the title of a section to access it. From any page, click on the "Back to Table of Contents" footer to return. Content is organized into 4 major sections: Installation Elements, Site Development, Facilities Exteriors and Facilities Interiors.

This IFS document begins as a fill-in PDF form, which is fully editable, and becomes a "living document" that can be regularly updated by base-level personnel following a format that is consistent across the Air Force. While the format is standardized, IFS content is customized for base operations and the local climate to ensure mission success while emphasizing reduced maintenance and reduced initial costs, life-cycle costs, energy use, and water use.

1. Conformance to Air Force Corporate Facilities Standards (AFCFS) and Installation Facilities Standards (IFS) are required by Air Force Instruction (AFI) 32-1023 and Air Force Memorandum. Please refer to the AFCFS website for links to documentation on current policy.
2. Requests to deviate from any installation facilities standards, that are Unified Facilities Criteria (UFC) requirements, will follow the process outlined in the AFCFS for UFC waivers and exemptions.
3. The IFS is a component plan of the Installation Development Plan (IDP) per Air Force Instruction (AFI) 32-7062 (replacing the Architectural Compatibility Plan). All military construction projects and Non-Appropriated Funds (NAF) facilities are required to comply with the IDP and its IFS component plan by AFI 32-1023. The Base Civil Engineer (BCE) maintains and implements the IDP and its component plans, to include the IFS.
4. Please refer to the AFCFS website as a portal to reference materials and requirements documents for design and construction projects (via links). Specific references to current DoD memoranda and Air Force criteria are updated periodically to provide the most current guidance and requirements. Programming, design and contract documents should list "current edition" for all reference and requirements documents. The documents in force at the date of execution of the design and/or construction contract shall be the governing version.
5. *Advanced Modeling Requirements:*
For all Air Force projects requiring advanced modeling, to include 3D visualization, Building Information Modeling (BIM), facility data, quantity take-off, geospatial, etc., follow the Army standards. Refer to USACE Minimum Model Matrix (M3) and Project Execution Plan (PxP) which outline required model uses. Refer to [CAD BIM Technology Center \(Contract Requirements\)](#) for more information on M3 and PxP.
6. Joint Bases shall implement IFS under their Joint-Base designation with volume numbers for individual installations following the IFS Development Tool template. For example, for Joint Base Langley-Eustis, provide: Vol. 1 Langley AFB and Vol. 2 Fort Eustis.
7. References and Supplementary Documents listed in Appendix G are included in these Installation Facilities Standards by reference and are fully part of this document. Please refer to [Appendix G](#) for a listing of documents, which are available via hyperlink for viewing and downloading.

Applicable N/A Select number of graphics / images (large: 800 px x 440 px) to insert 1

Image Tool 800 x 440

Applicable N/A Select number of graphics / images (small: 250 px x 188 px) to insert 3

Image Tool 250 x 188



Tenant Facility with Buckley Air Force Base Design Standards



Group 1 Architectural Features



Native Grasses and Trees



Porte Cochere at Group 2 Lodging

A01. FACILITY HIERARCHY

Comply with AF Corporate Standards for Facility Hierarchy (and subsections):

<http://afcs.wbdg.org/facility-hierarchy/index.html>

A02. FACILITY QUALITY

Comply with AF Corporate Standards for Facility Quality (and subsections):

<http://afcs.wbdg.org/facility-quality/index.html>

A03. FACILITY DISTRICTS

Comply with AF Corporate Standards for Facility Districts (and subsections):

<http://afcs.wbdg.org/facility-districts/index.html>

Image Tool 800 x 800

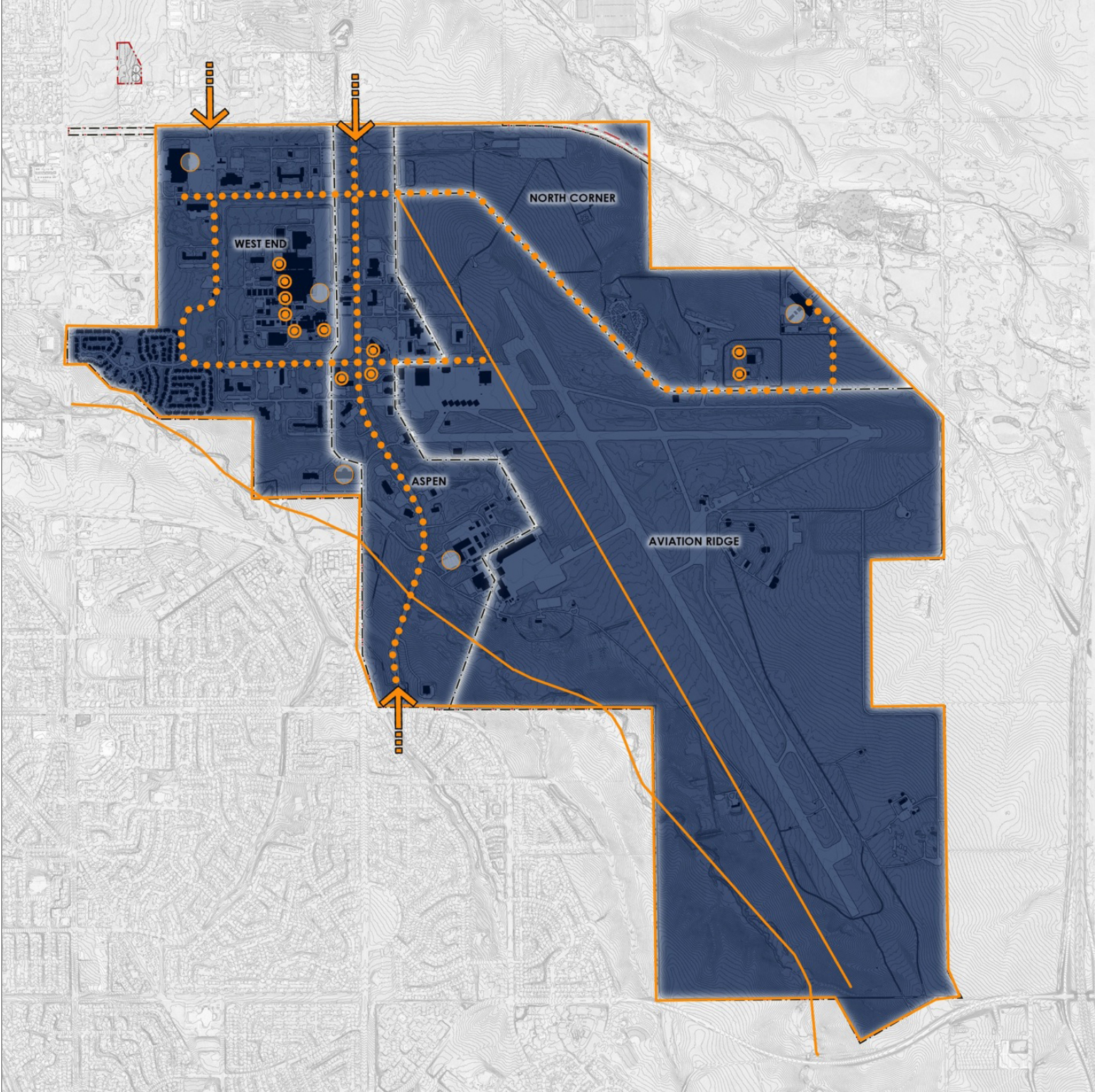

Note: Apply the base-wide standards in this IFS for Installation Elements, Site Development, Facilities Exteriors and Facilities Interiors (products, materials, color, etc.). Following application of the base-wide standards, refer to the Appendix and apply any additional requirements specifically related to the Facility District.

B. INSTALLATION ELEMENTS

Comply with Air Force Corporate Standards for Installation Elements:

<http://afcfs.wbdg.org/installation-elements/index.html>

B01. COMPREHENSIVE PLANNING

Comply with Air Force Corporate Standards for Comprehensive Planning:

<http://afcfs.wbdg.org/installation-elements/comprehensive-planning/index.html>

B01.1. Installation Development Plan (IDP)

Applicable N/A Select number of graphics / images (large: 800 px x 440 px) to insert 2

Image Tool 800 x 440

Applicable N/A Select number of graphics / images (small: 250 px x 188 px) to insert 1

Image Tool 250 x 188

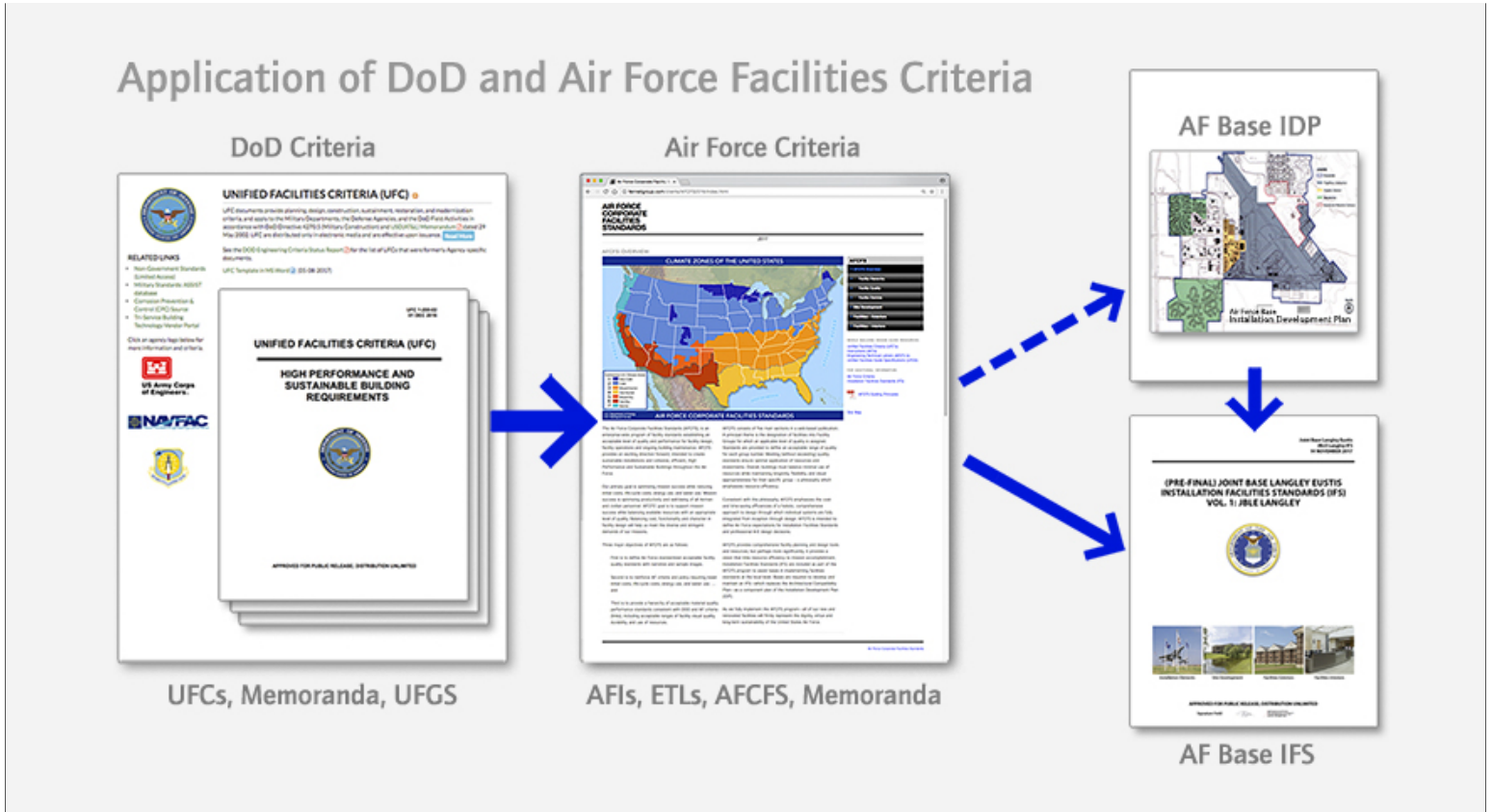

Department of Defense, Department of the Air Force and Air Force Base Criteria

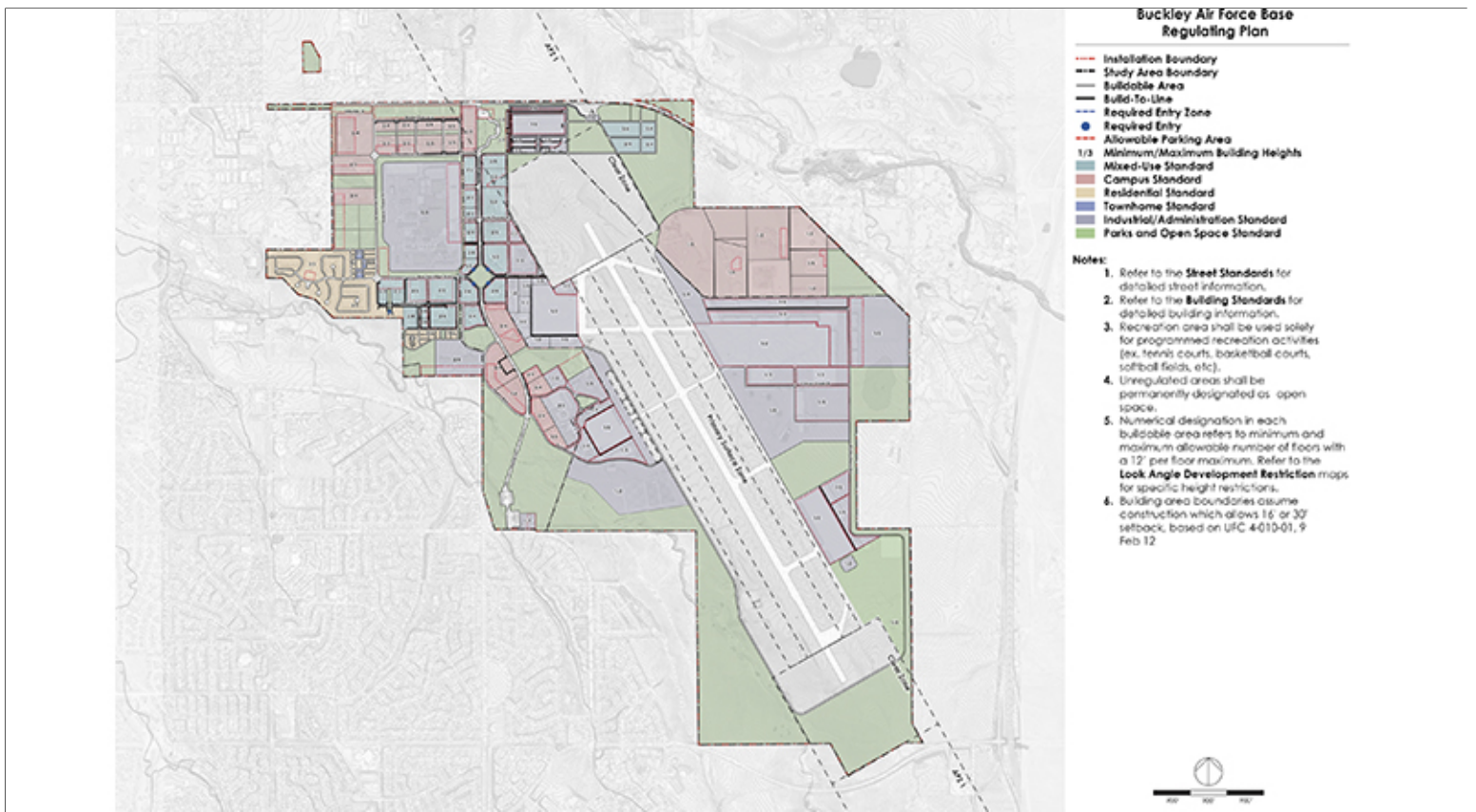

Buckley Air Force Base Regulating Plan

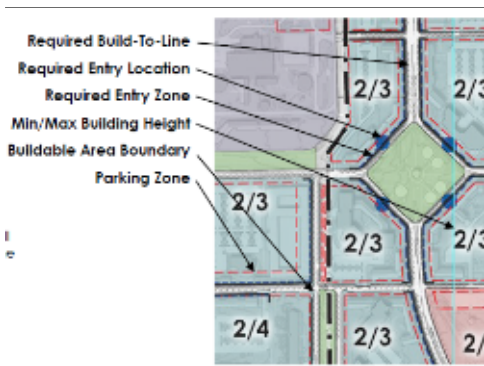

Detail of Regulating Plan

1. The Base Civil Engineer is responsible for developing, maintaining and implementing the installation's Comprehensive Planning documents and to ensure that the Installation Development Plan (IDP) is prepared, maintained, and implemented following AFI 32-7062.
2. The Regulating Plan is the controlling document and principal tool for implementing the study area form-based code. It identifies the Building Envelope Standard for each building site and any specific characteristics assigned to it. The notes and definitions below serve as a reference to explain the elements of the Regulating Plan:
3. Specific Notes on Regulating Plan:
 - a. Unless otherwise noted, all buildings shall maintain a width of 50' or less to maximize natural light.
 - b. Undeveloped lots shall not be developed into parking areas unless specifically noted as a parking area on the regulating plan. As a rule, all parking, unless otherwise designated on the plan, shall be located to the sides or to the rear of buildings.
 - c. Existing buildings that are not slated for demolition are not required to meet the guidelines of the Regulating Plan. Only buildings constructed on redeveloped lots must meet the requirements. If a design team wishes to deviate from the Regulating and Transportation Plans, they must follow the variance established by the installation.
 - d. Definitions:
 - i. Required Entry Zone: A blue dashed line indicating a facade that must include a building entry.

- ii. Required Entry Location: A blue circle indicating a location where a building entry is required.
- iii. Required Build-to Line: A thick black line where a percentage of the building façade must be located (see Building Envelope Standards for specific percentages).
- iv. Min/Max Building Height: Two numbers indicating the minimum and maximum number of levels a building may have within the coordinating building area boundary.
- v. Building Area Boundary: A highlighted area showing the maximum extent of buildable area on a parcel. This refers to the colored parcel on the map.
- vi. Parking Zone: A red dashed line indicating the maximum allowable area to be used for parking.

B01.1.1. IFS Component Plan of IDP

Applicable N/A Select number of graphics / images (large: 800 px x 440 px) to insert 4

Image Tool 800 x 440

Applicable N/A Small graphics do not apply



Aspen ADP

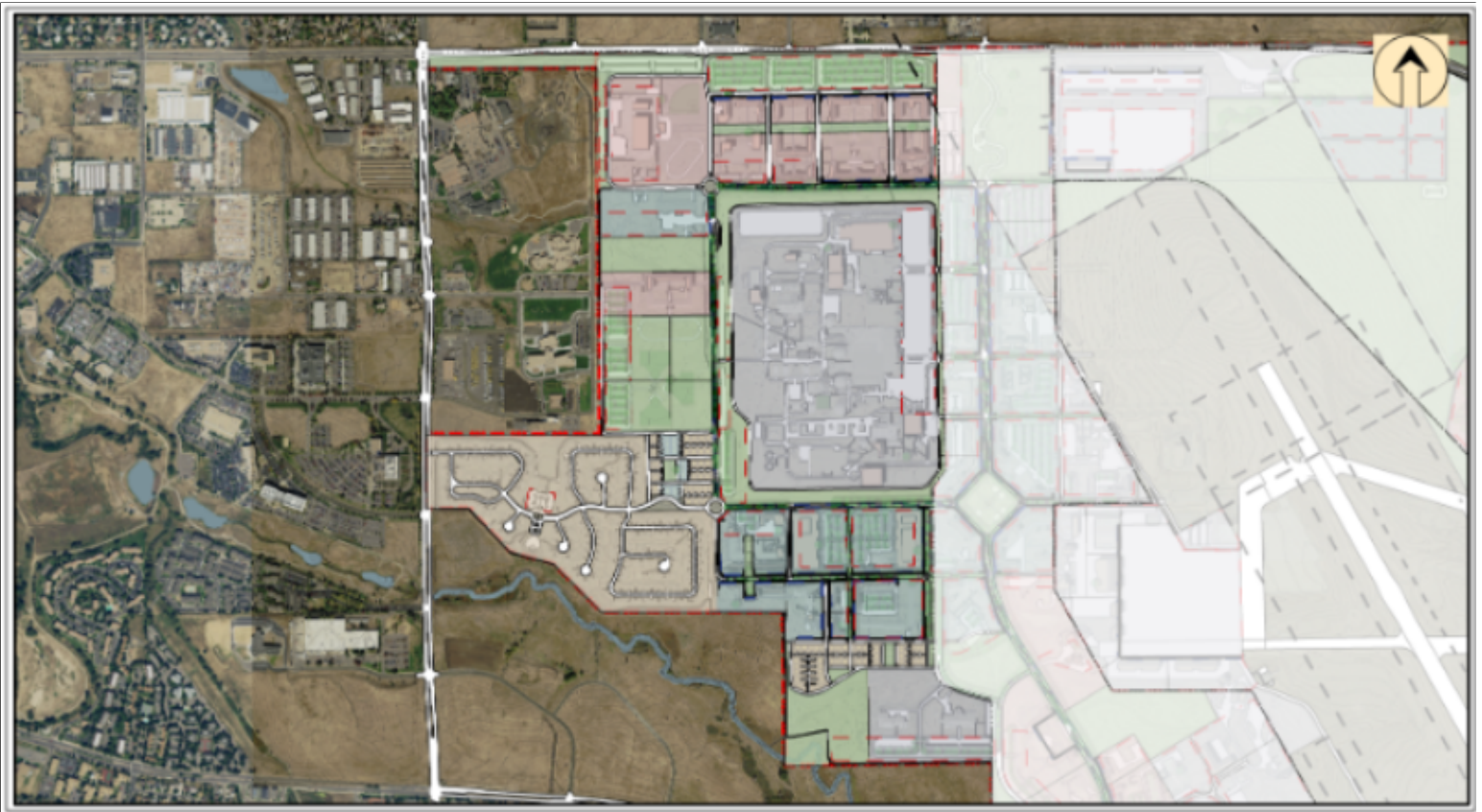

West End ADP

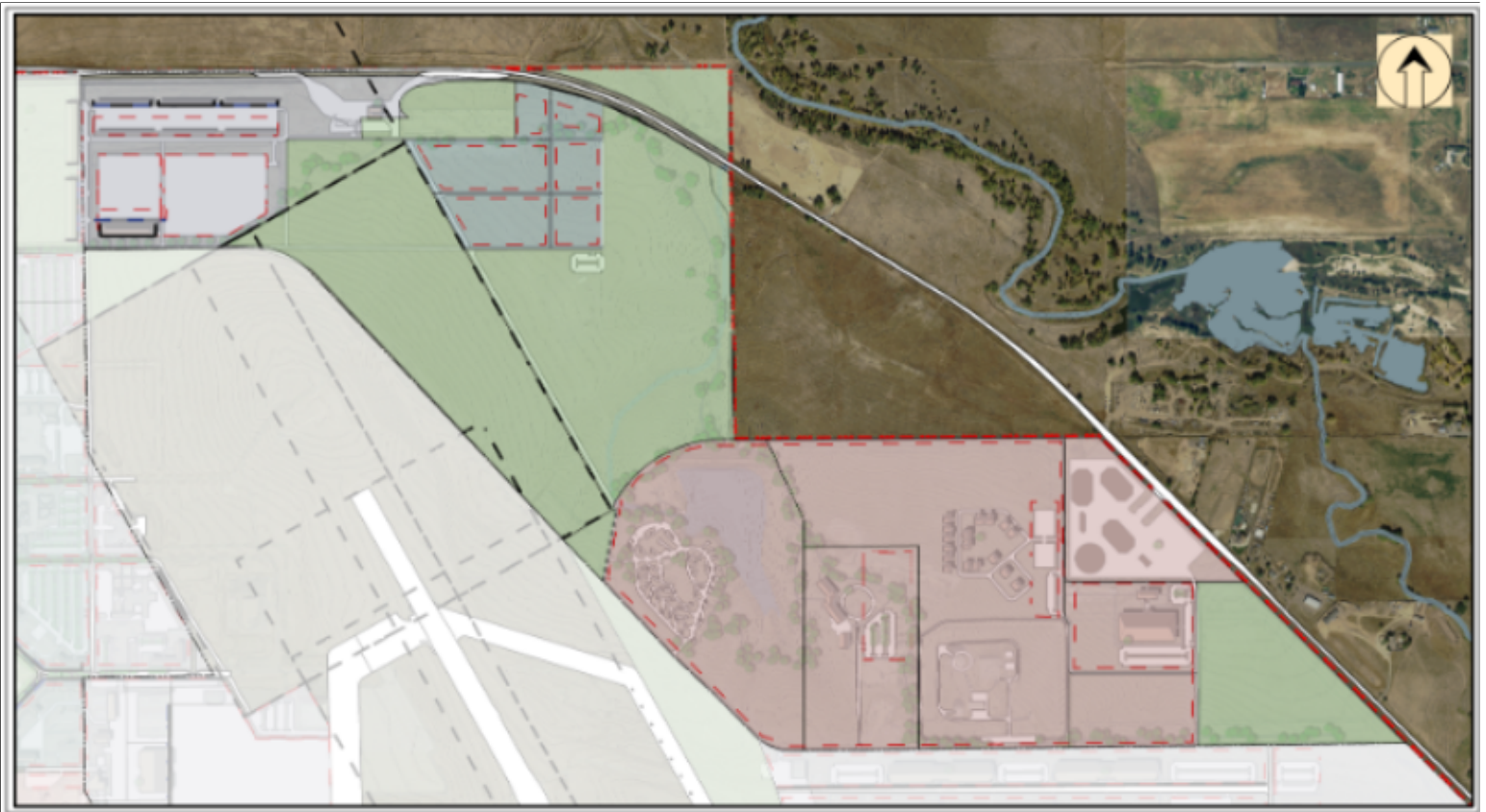

North Corner ADP

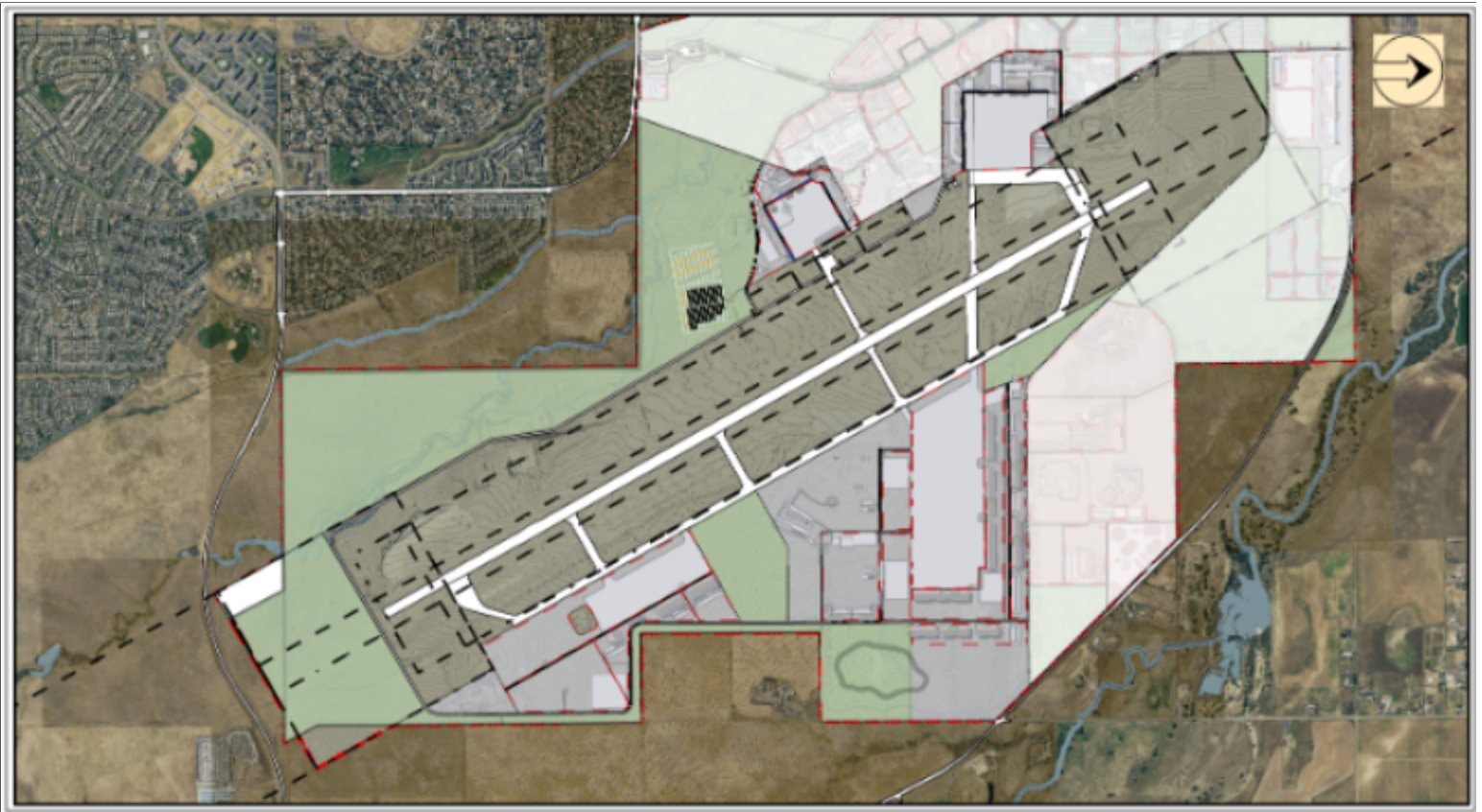

Aviation Ridge ADP

1. Maintain this Installation Facilities Standards (IFS) as a Component Plan of the base's Installation Development Plan (IDP).

B01.1.2. Brief History of Base

Applicable N/A Select number of graphics / images (large: 800 px x 440 px) to insert 1

Image Tool 800 x 440

Applicable N/A Select number of graphics / images (small: 250 px x 188 px) to insert 3

Image Tool 250 x 188



Buckley Field



Housing at Buckley Field



Guard House at Buckley Field



Buckley Air National Guard Base

The increased involvement of the United States in the war in 1941 resulted in plans to enlarge Lowry Army Air Field in the Denver area. A 5,740-acre site was selected and eventually purchased by the City and County of Denver and donated to the War Department in early 1941 to satisfy the growing need for military strength. That property became known as Buckley Field.

The base is named after 1st Lt. John Harold Buckley, a World War I flier from Longmont, Colo. He was shot down on a strafing mission behind German lines during the Argonne offensive.

A contract for architectural and engineering services was awarded in April 1942 and construction of Buckley Field began the following month. The Army Air Corps

Technical School, offering B-17 and B-24 bombardier and armor training, was opened July 1 with Brig. Gen. L.A. Lawson commanding.

At an original cost of \$7.5 million, base facilities included streets, runways, more than 700 structures, 10 water wells, a water distribution system, a sewage collection and treatment system, electrical plant, communication system, coal-fired steam heating plant and 16,800 feet of railroad track.

The ever-present need for wartime military personnel required additional basic training sites. In 1943, three of these sites were opened at the Lowry Bombing Range under Buckley's command.

As the Army Air Corps approached full strength in 1944, the additional training requirements diminished, bringing about a gradual decline in personnel throughout 1945. When the war finally ended, Buckley became an auxiliary field for Lowry, which in turn, transferred it to the Colorado Air National Guard in 1946.

But the Air Guard's first-term ownership quickly came to an end when the Department of the Navy took charge in 1947, renaming the installation Naval Air Station-Denver.

Nearly 12 years later, the Navy decommissioned Denver's Naval Air Station on June 30, 1959, and returned the installation back to the Air Force, which licensed it to the state of Colorado.

On April 18, 1960, the installation took on a new, yet familiar name, Buckley Air National Guard Base, and became the first stand-alone Air National Guard base in the United States. For the next 40 years, the Air National Guard would maintain Buckley as an Air National Guard installation.

On Oct. 1, 2000, Buckley once again changed hands. This time it would be back to the U.S. Air Force as the 821st Space Group became the host unit and the Secretary of the Air Force renamed the facility Buckley Air Force Base.

Just a year later, the 460th Air Base Wing, 14th Air Force's (Air Force Space Command) newest wing, stood up and assumed host duties of the base, and three years later, in August 2004, the 460th Air Base Wing became the 460th Space Wing.

The name change came about as the 460th Air Base Wing assumed management responsibilities following the 821st Space Group's inactivation Sept. 30. With the new title also came an increase in manpower to provide host-base responsibilities and base operating support.

The 460th Air Base Wing was re-designated the 460th Space Wing on Aug. 19, 2004, and assumed operational responsibilities for the 2nd, 8th and 137th Space Warning Squadrons from the 21st Space Wing. Today, the 460th Space Wing is the focal point for the Air Force's space-based missile warning and communications missions.

However, through all the changes, the Colorado Air National Guard has continued to operate the most visible mission at the base, F-16 Fighting Falcon flight and training operations.

B01.1.3. Future Development

Applicable N/A Large graphics do not apply

Applicable N/A Small graphics do not apply

1. Future development will adhere to IDP regulating plan.

B02. STREET ENVELOPE STANDARDS

Comply with Air Force Corporate Standards for Installation Elements:

<http://afcs.wbdg.org/installation-elements/index.html>

Comply with AF Corporate Standards for Street Envelope Standards:

<http://afcs.wbdg.org/installation-elements/street-envelope-standards/index.html>

B02.1. Hierarchy of Streets

Applicable N/A Select number of graphics / images (large: 800 px x 440 px) to insert 1

Image Tool 800 x 440

Applicable N/A Small graphics do not apply

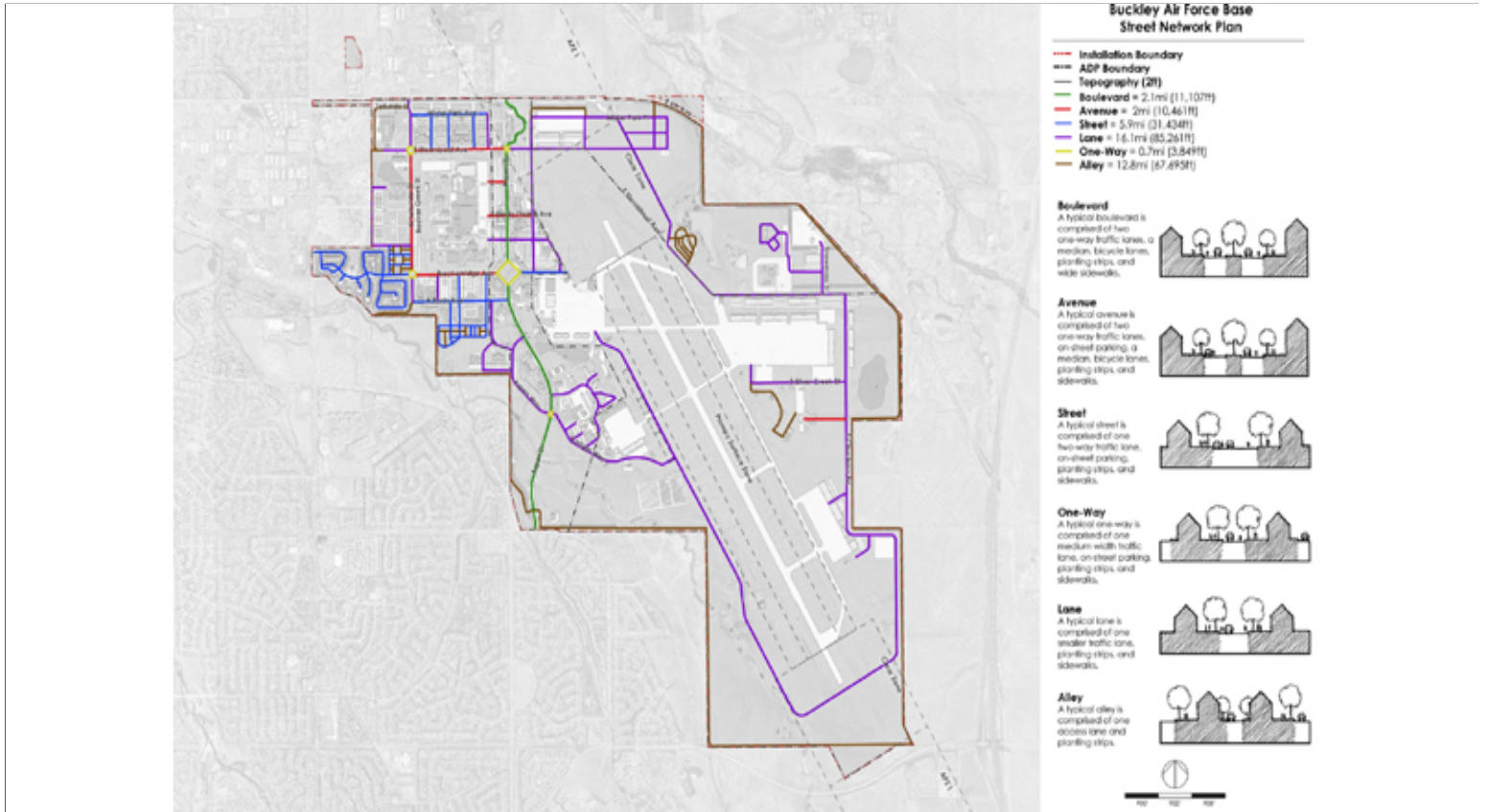

Street Network Plan

1. Develop and evolve a hierarchical transportation network of arterial, collector and local streets following UFC 3-201-01 and its industry references.
2. Provide consistent functionality throughout the installation and a level of visual quality relating to the adjacent Facility Group number.
3. Routes along facilities in Group 1 may have materials, finishes and features with a higher visual quality than Groups 2, 3 and 4. Reduce maintenance requirements by installing highly durable materials and finishes in routes along Group 3 industrial facilities.
4. Special routes may have a visual quality comparable to those along facilities in Group 1.
5. Create and maintain arterials with two lanes of traffic in each direction with landscaped or paved medians as applicable to the local climate and adjacent facility group designation / land use.
6. Minimize stops and turns along arterials. Eliminate on-street parking along arterials and collector streets.

7. Connect arterials to local streets with appropriately scaled collector streets.
8. Provide appropriate landscape setbacks and pedestrian buffers along all streets.
9. Minimize and consolidate curb cuts along streets.
10. Ensure access for emergency and service vehicles.
11. Define bicycle traffic routes in the Installation Development Plan or its applicable component plans.
12. Provide illustrations in the Installation Facilities Standards (IFS) to include street cross-sections and plans for every type of street specified on the installation. At a minimum provide dimensions for vehicular traffic-lanes, curb radii, medians, bike lanes, pedestrian buffers, sidewalks, crosswalks, tree planting areas, and on-street parking configurations.
13. Define appropriate force protection features, site furnishings, signs, lighting, utilities, and paving in the IFS.

B02.1.1. Arterial Streets

Applicable N/A Select number of graphics / images (large: 800 px x 440 px) to insert 2

Image Tool 800 x 440

Applicable N/A Select number of graphics / images (small: 250 px x 188 px) to insert 1

Image Tool 250 x 188

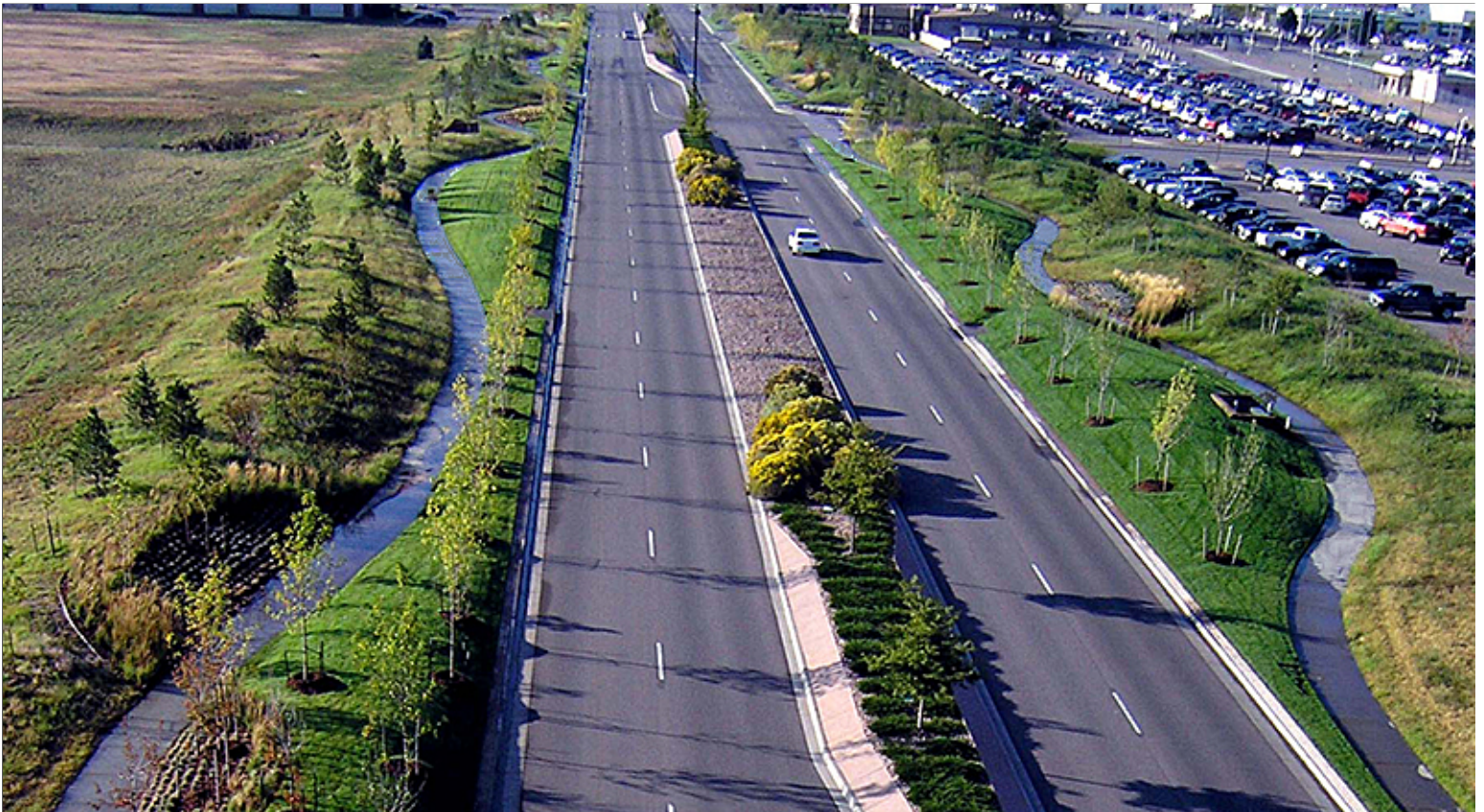

Transitional Landscape from Native to Maintained

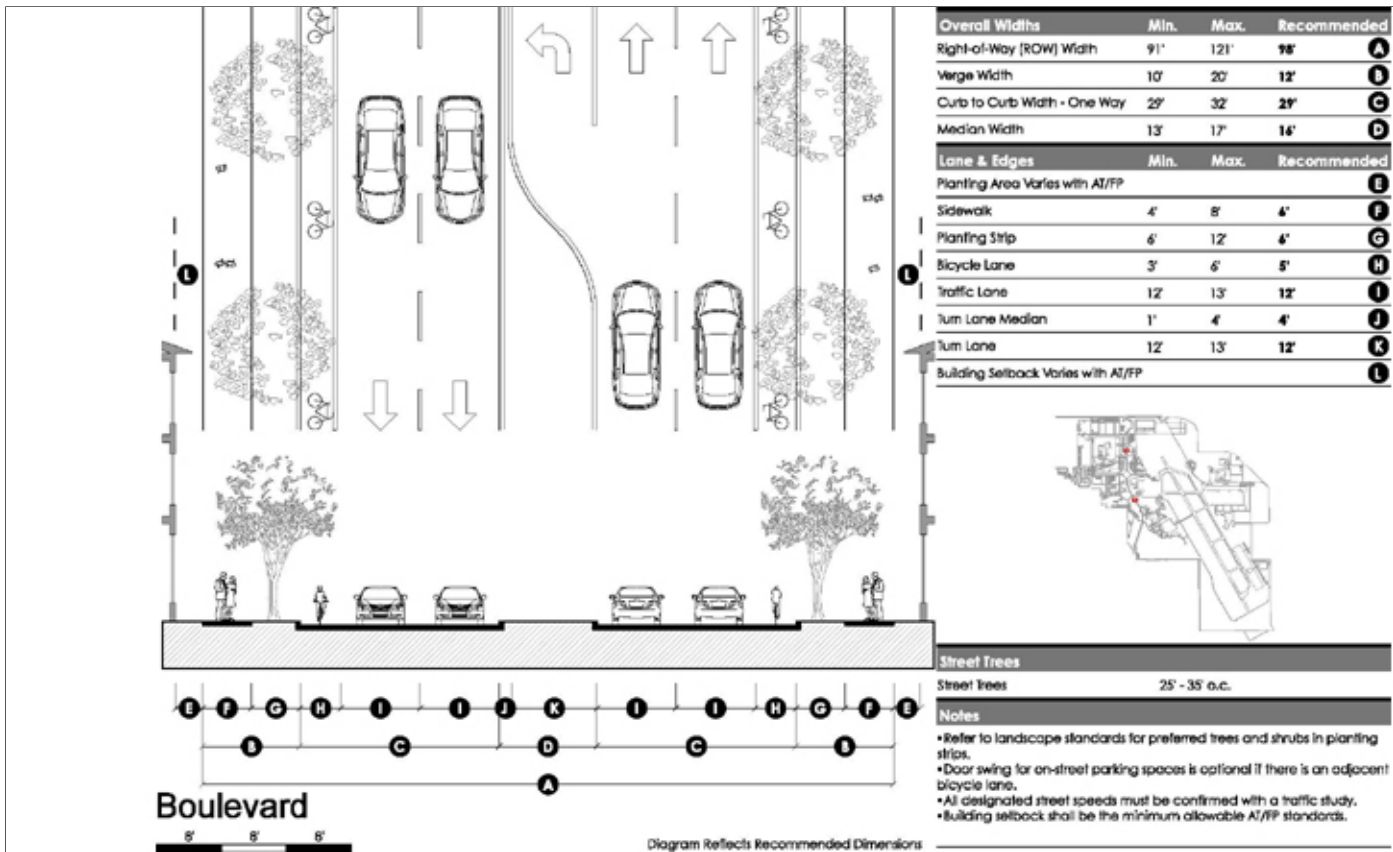

Typical Arterial Street Diagram

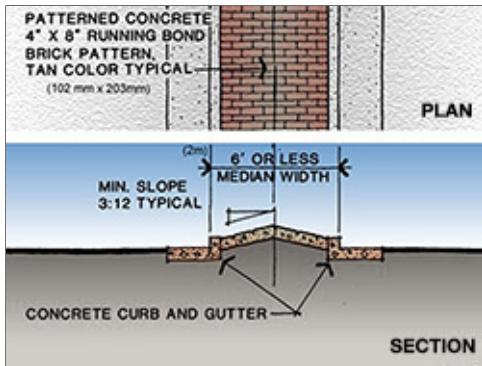

Paved Median

1. Maintain the following with this designation as arterial streets: Aspen St. (Re: B02.1 graphic for location). Refer to the illustration for general dimensions that pertain to all base arterial streets.

2. The following specific requirements shall be incorporated into all arterial projects including roadway modifications/upgrades and associated building sites adjacent to the street.

B02.1.2. Collector Streets

Applicable N/A Select number of graphics / images (large: 800 px x 440 px) to insert 3

Image Tool 800 x 440

Applicable N/A Small graphics do not apply

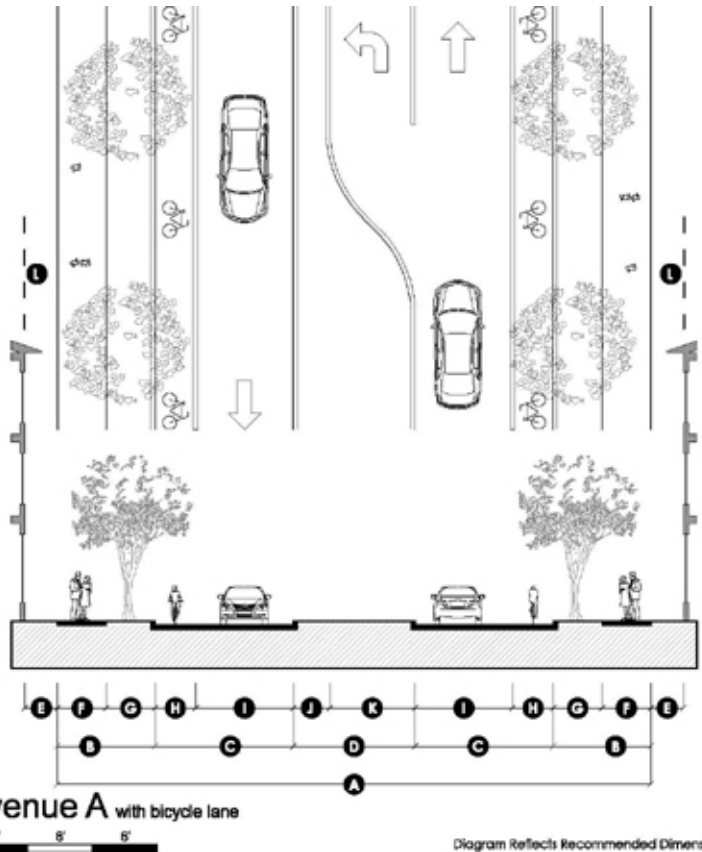

Overall Widths	Min.	Max.	Recommended
Right-of-Way (ROW) Width	60'	93'	73' A
Verge Width	10'	20'	12' B
Curb to Curb Width - One Way	14'	19'	17' C
Median Width	12'	15'	15' D
Lane & Edges	Min.	Max.	Recommended
Planting Area Varies with AT/FP E			
Sidewalk	4'	8'	4' F
Planting Strip	6'	12'	4' G
Bicycle Lane	3'	6'	5' H
Traffic Lane	12'	13'	12' I
Turn Lane Median	1'	3'	3' J
Turn Lane	12'	13'	12' K
Building Setback Varies with AT/FP L			



Street Trees	
Street trees	25' - 35' o.c.
Notes	
<ul style="list-style-type: none"> Refer to landscape standards for preferred trees and shrubs in planting strips. Door swing for on-street parking spaces is optional if there is an adjacent bicycle lane. All designated street speeds must be confirmed with a traffic study. Building setback shall be the minimum allowable AT/FP standards. 	

Diagram Reflects Recommended Dimensions

Typical Collector Street Diagram

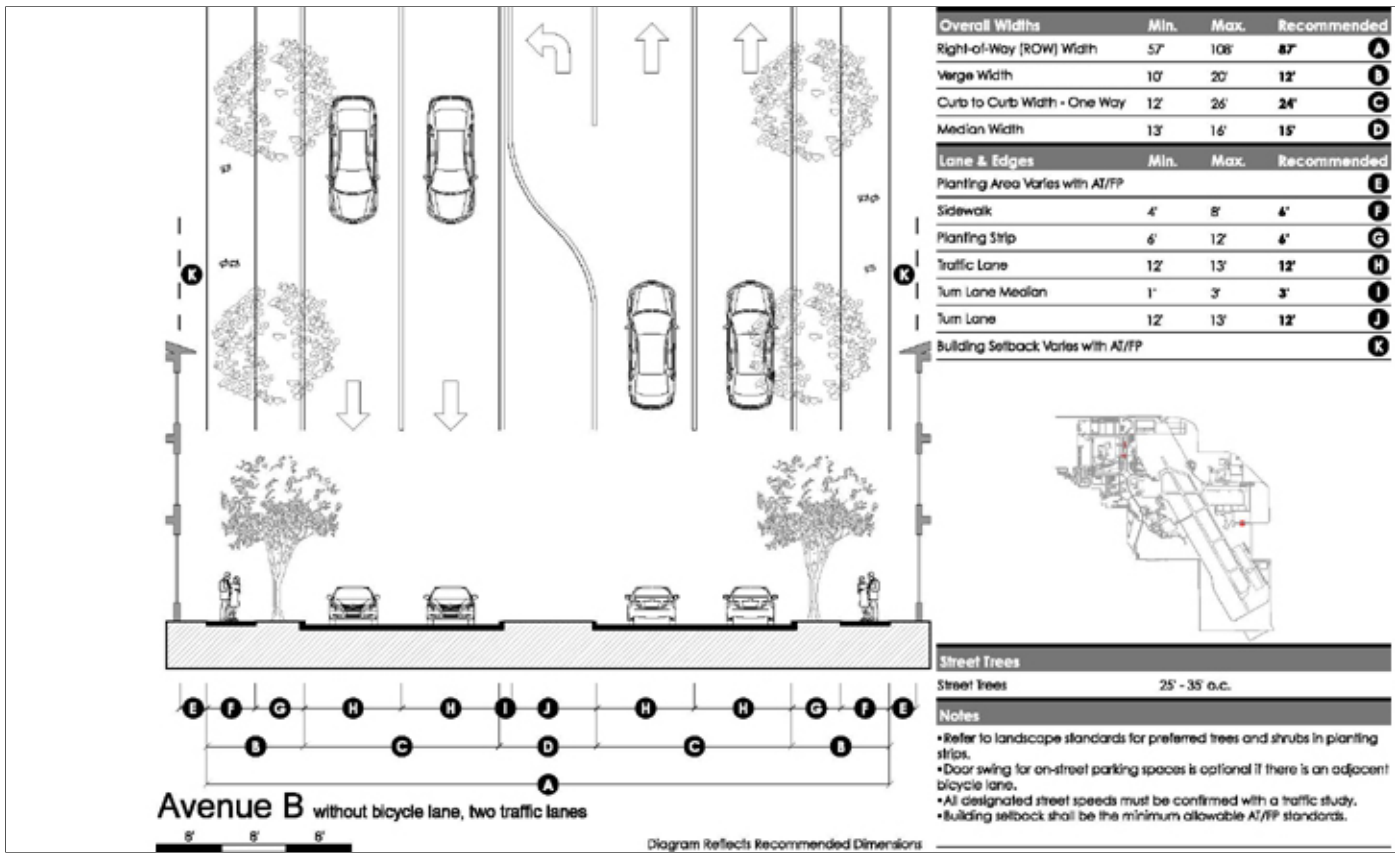

Typical Collector Street Diagram - Alternate B

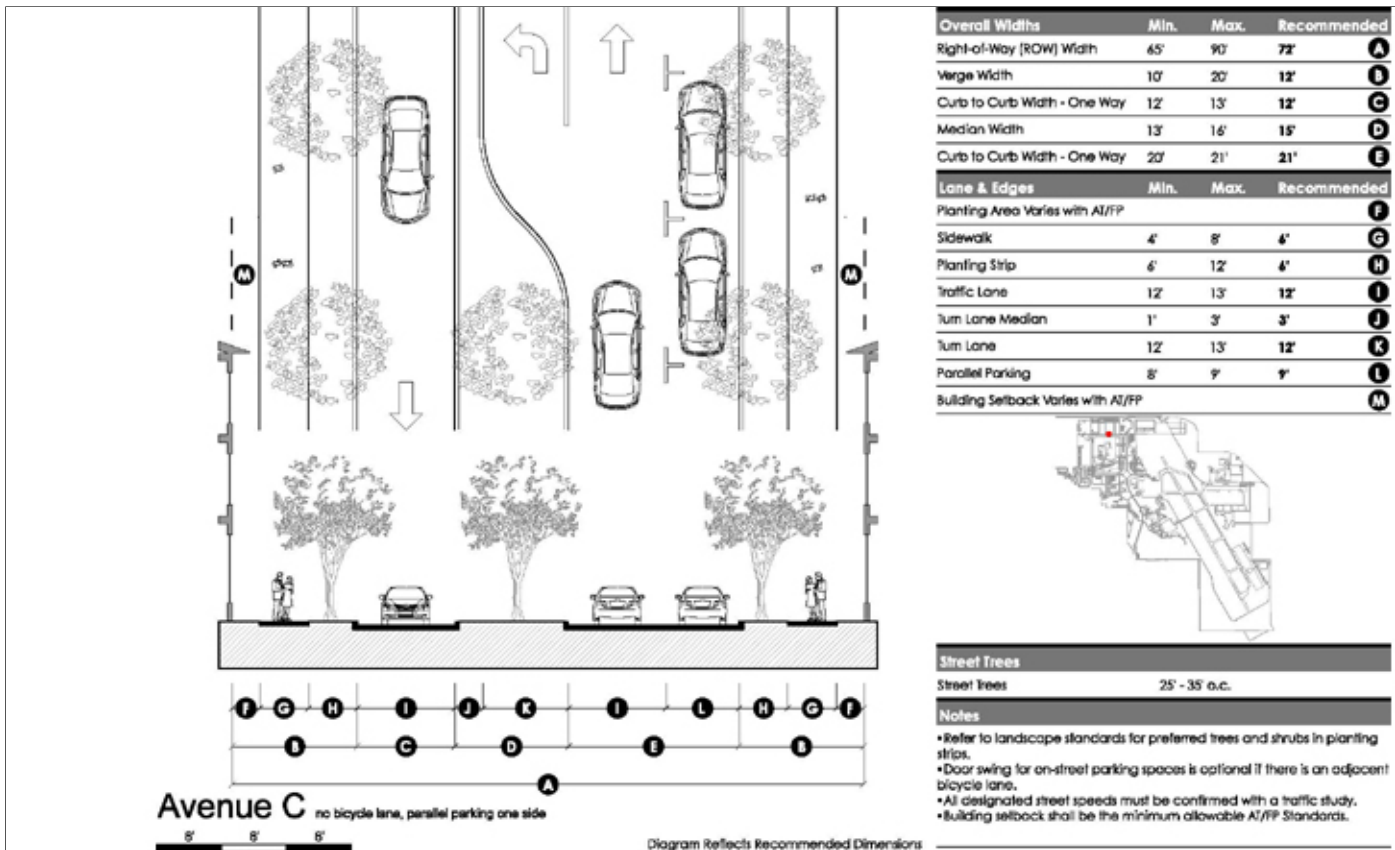

Typical Collector Street Diagram - Alternate C

1. Design collector streets less prominent than arterials.

2. Maintain the following as collector streets: portion of Telluride St., portion of Breckenridge Ave., portion of Steamboat Ave. (Re: B02.1 graphic for location). Refer to the illustration for general dimensions that pertain to all base collector streets.

3. Match the level of quality of street elements to the adjacent Facility Group number.

B02.1.3. Local Streets

Applicable N/A Select number of graphics / images (large: 800 px x 440 px) to insert 5

Image Tool 800 x 440

Applicable N/A Small graphics do not apply



Typical Local Street in Family Housing Area

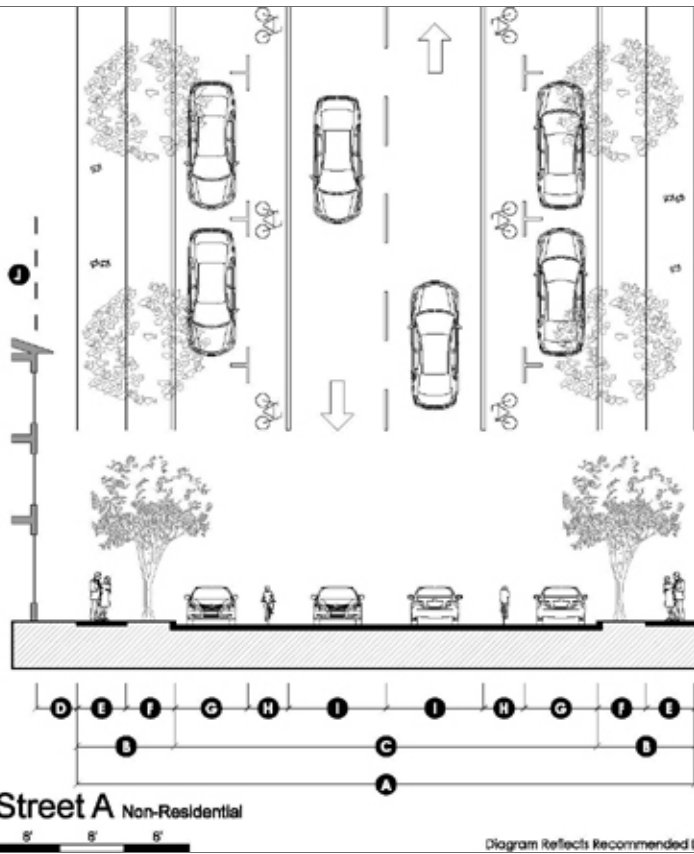

Street A Non-Residential

Diagram Reflects Recommended Dimensions

Overall Widths	Min.	Max.	Recommended
Right-of-Way (ROW) Width	66'	96'	74' A
Verge Width	10'	20'	12' I
Curb to Curb Width	46'	56'	52' C

Lane & Edges	Min.	Max.	Recommended
Planting Area Varies with AI/FP			D
Sidewalk	4'	8'	4' E
Planting Strip	6'	12'	4' F
Bicycle Lane	3'	6'	5' G
Parallel Parking	8'	9'	9' H
Traffic Lane	12'	13'	12' I
Building Setback Varies with AI/FP			J



Street Trees

Street Trees 25' - 35' o.c.

Notes

- Refer to landscape standards for preferred trees and shrubs in planting strips.
- Door swing for on-street parking spaces is optional if there is an adjacent bicycle lane.
- All designated street speeds must be confirmed with a traffic study.
- Building setback shall be the minimum allowable AI/FP standards.

Typical Local Street Diagram

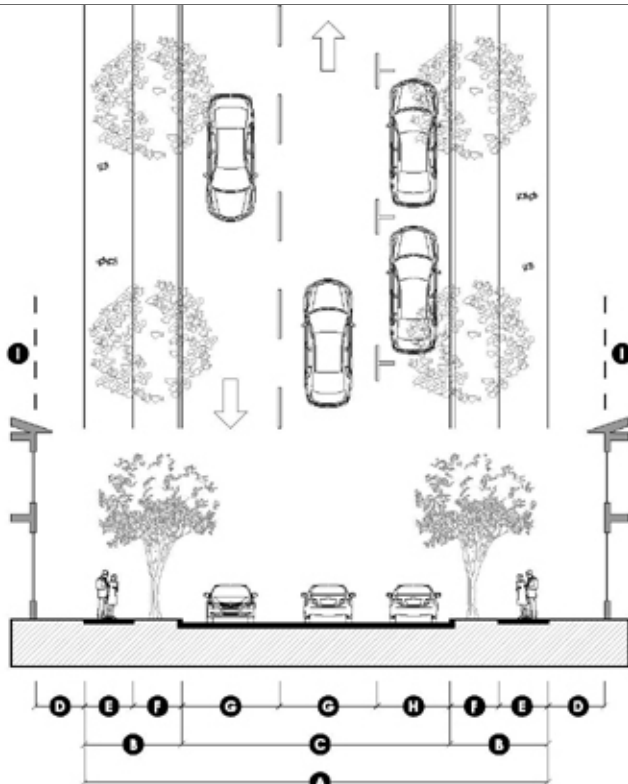

Street B Residential or parks, parallel parking one side

Diagram Reflects Recommended Dimensions

Overall Widths	Min.	Max.	Recommended
Right-of-Way (ROW) Width	52'	75'	57' A
Verge Width	10'	20'	12' I
Curb to Curb Width	32'	35'	33' C

Lane & Edges	Min.	Max.	Recommended
Planting Area Varies with AI/FP			D
Sidewalk	4'	8'	4' E
Planting Strip	6'	12'	4' F
Traffic Lane	12'	13'	12' G
Parallel Parking	8'	9'	9' H
Building Setback Varies with AI/FP			I



Street Trees

Street Trees 25' - 35' o.c.

Notes

- Refer to landscape standards for preferred trees and shrubs in planting strips.
- Door swing for on-street parking spaces is optional if there is an adjacent bicycle lane.
- All designated street speeds must be confirmed with a traffic study.
- Building setback shall be the minimum allowable AI/FP standards.

Typical Local Street Diagram - Alternate B

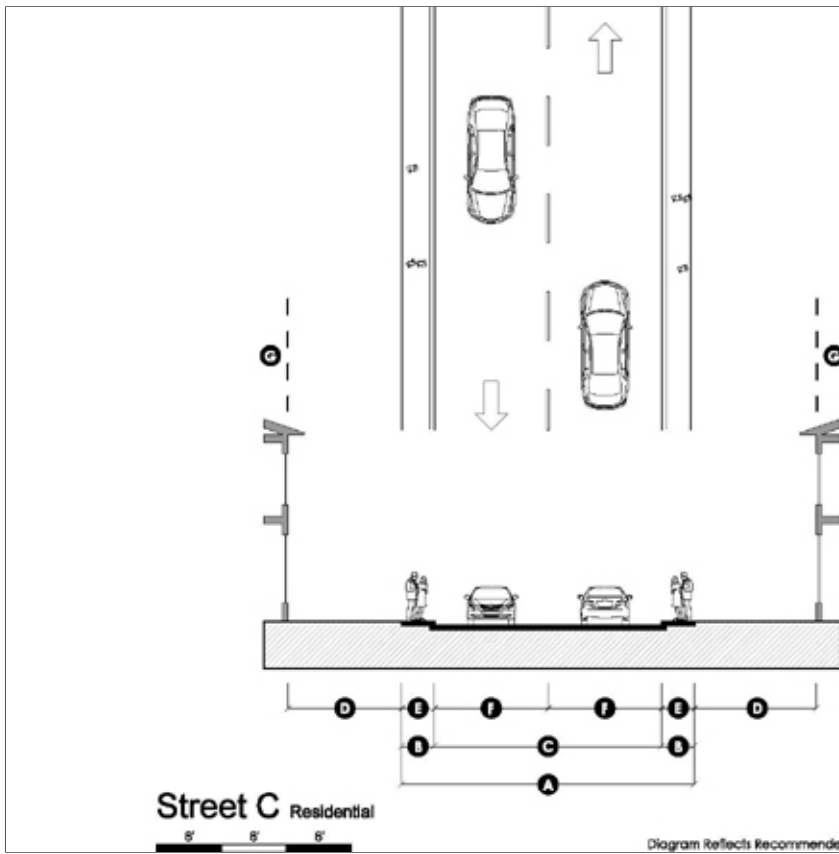

Overall Widths	Min.	Max.	Recommended
Right-of-Way (ROW) Width	32'	42'	34' A
Verge Width	4'	8'	4' I
Curb to Curb Width	24'	28'	28' G

Lane & Edges	Min.	Max.	Recommended
Planting Area Varies with AI/FP			D
Sidewalk	4'	8'	4' E
Traffic Lane	12'	14'	14' F
Building Setback Varies with AI/FP			G



Street Trees	Min.	Max.	Recommended
Street Trees	25'	35' o.c.	

- Notes**
- Refer to landscape standards for preferred trees and shrubs in planting strips.
 - Door swing for on-street parking spaces is optional if there is an adjacent bicycle lane.
 - All designated street speeds must be confirmed with a traffic study.
 - Building setback shall be the minimum allowable AI/FP standards.

Diagram Reflects Recommended Dimensions

Typical Local Street Diagram - Alternate C

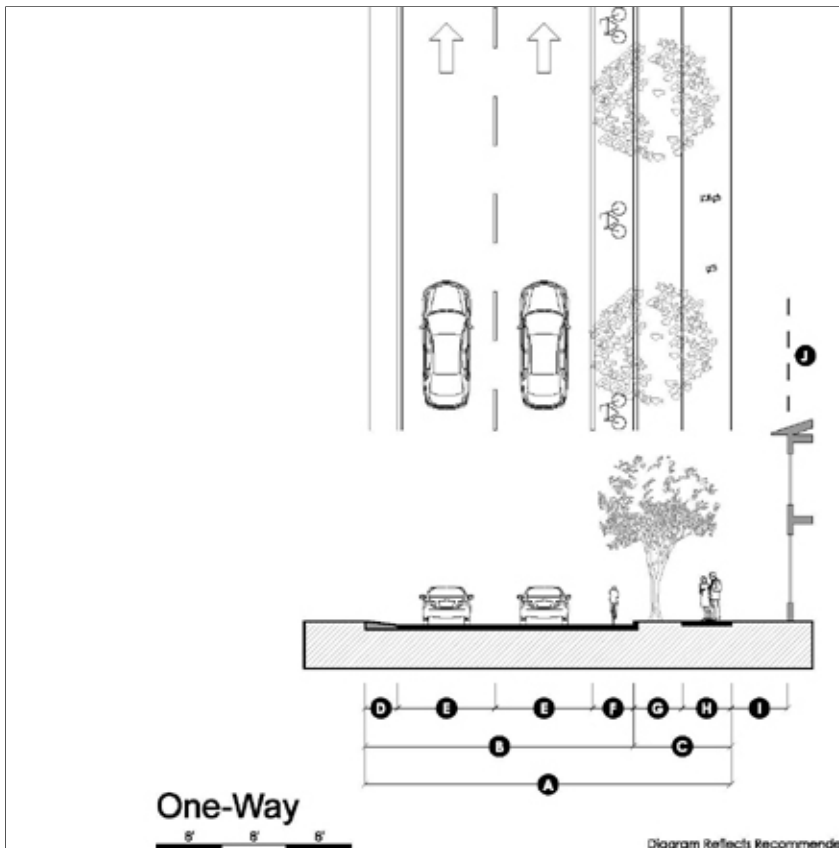

Overall Widths	Min.	Max.	Recommended
Right-of-Way (ROW) Width	39'	46'	45' A
Verge Width	8'	16'	12' I
Curb to Curb Width	31'	40'	35' G

Lane & Edges	Min.	Max.	Recommended
Shoulder	4'	8'	4' D
Traffic Lane	12'	13'	12' E
Bicycle Lane	3'	6'	5' F
Planting Strip	4'	8'	4' G
Sidewalk	4'	8'	4' H
Planting Area Varies with AI/FP			I
Building Setback Varies with AI/FP			J



Street Trees	Min.	Max.	Recommended
Street Trees	25'	35' o.c.	

- Notes**
- Refer to landscape standards for preferred trees and shrubs in planting strips.
 - Door swing for on-street parking spaces is optional if there is an adjacent bicycle lane.
 - All designated street speeds must be confirmed with a traffic study.
 - Building setback shall be the minimum allowable AI/FP standards.

Diagram Reflects Recommended Dimensions

Typical Local Street Diagram - One Way

1. Design and maintain local streets in due proportion to the amount of traffic.

2. Generally encourage the development of street frontage of adjacent sites to positively contribute features such as landscaping.

3. Maintain consistent local streetscapes for visual and functional continuity

B02.1.4. Special Routes

Applicable N/A Select number of graphics / images (large: 800 px x 440 px) to insert 5

Image Tool 800 x 440

Applicable N/A Small graphics do not apply

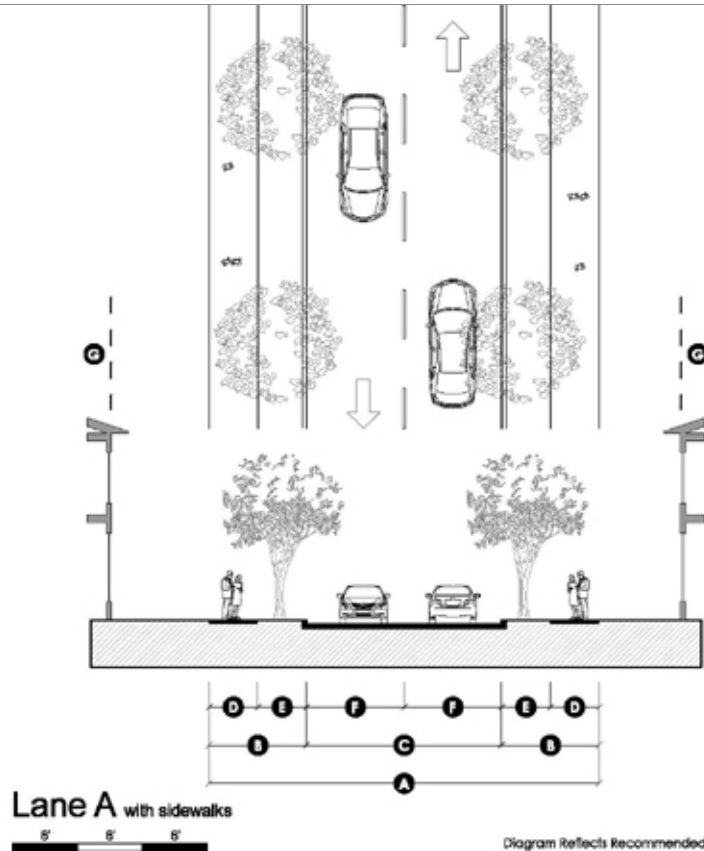

Overall Widths	Min.	Max.	Recommended
Right-of-Way (ROW) Width	48'	66'	48' A
Verge Width	12'	20'	12' B
Curb to Curb Width	24'	26'	24' C

Lane & Edges	Min.	Max.	Recommended
Sidewalk	6'	8'	6' D
Planting Strip	6'	12'	6' E
Traffic Lane	12'	13'	12' F
Building Setback	Varies with AT/FP		G

Lane Locations with sidewalks both sides



Street Trees	Street Trees
Street Trees	25' - 35' o.c.

- Notes**
- Refer to landscape standards for preferred trees and shrubs in planting strips.
 - Door swing for on-street parking spaces is optional if there is an adjacent bicycle lane.
 - All designated street speeds must be confirmed with a traffic study.
 - Building setback shall be the minimum allowable AT/FP standards.

Diagram Reflects Recommended Dimensions

Typical Local Street Diagram - Lane A

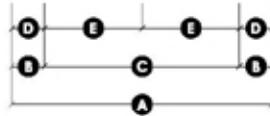
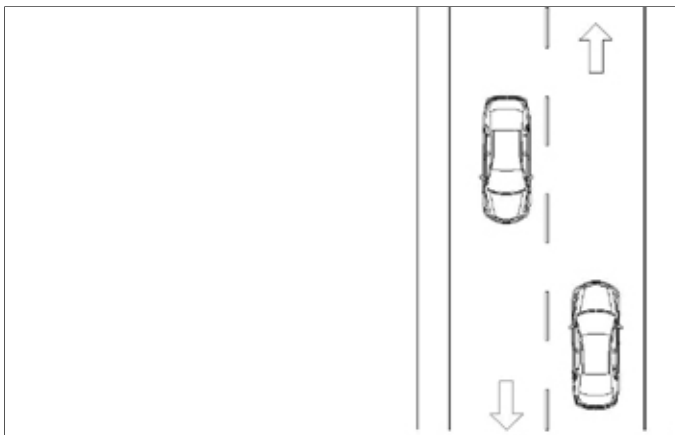

Lane B without sidewalks



Diagram Reflects Recommended Dimensions

Overall Widths	Min.	Max.	Recommended
Right-of-Way (ROW) Width	32'	42'	32' A
Verge Width	4'	8'	4' I
Curb to Curb Width	24'	26'	24' C

Lane & Edges	Min.	Max.	Recommended
Shoulder	4'	8'	4' D
Traffic Lane	12'	13'	12' E



Street Trees

Street Trees	25' - 35' o.c.
--------------	----------------

Notes

- Refer to landscape standards for preferred trees and shrubs in planting strips.
- Door swing for on-street parking spaces is optional if there is an adjacent bicycle lane.
- All designated street speeds must be confirmed with a traffic study.
- Building setback shall be the minimum allowable AT/FP standards.

Typical Local Street Diagram - Lane B

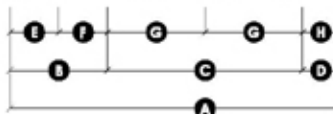
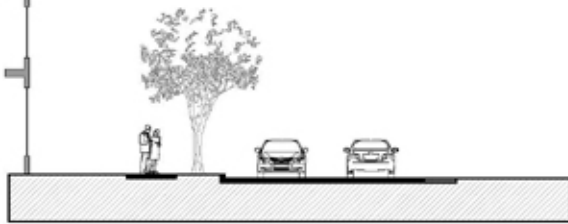
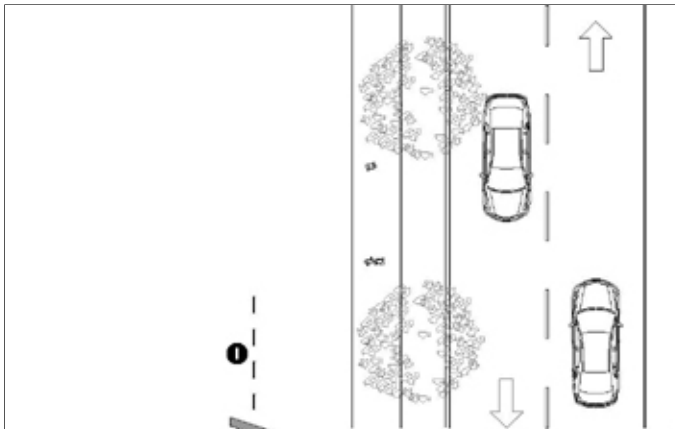

Lane C with a sidewalk and a shoulder



Diagram Reflects Recommended Dimensions

Overall Widths	Min.	Max.	Recommended
Right-of-Way (ROW) Width	40'	52'	40' A
Verge Width	12'	20'	12' I
Curb to Curb Width	24'	26'	24' C
Verge Width	4'	6'	4' D

Lane & Edges	Min.	Max.	Recommended
Sidewalk	6'	8'	6' E
Planting Strip	6'	12'	6' F
Traffic Lane	12'	13'	12' G
Shoulder	4'	6'	4' H
Building Setback Varies with AT/FP			I



Street Trees

Street Trees	25' - 35' o.c.
--------------	----------------

Notes

- Refer to landscape standards for preferred trees and shrubs in planting strips.
- Door swing for on-street parking spaces is optional if there is an adjacent bicycle lane.
- All designated street speeds must be confirmed with a traffic study.
- Building setback shall be the minimum allowable AT/FP standards.

Typical Local Street Diagram - Lane C

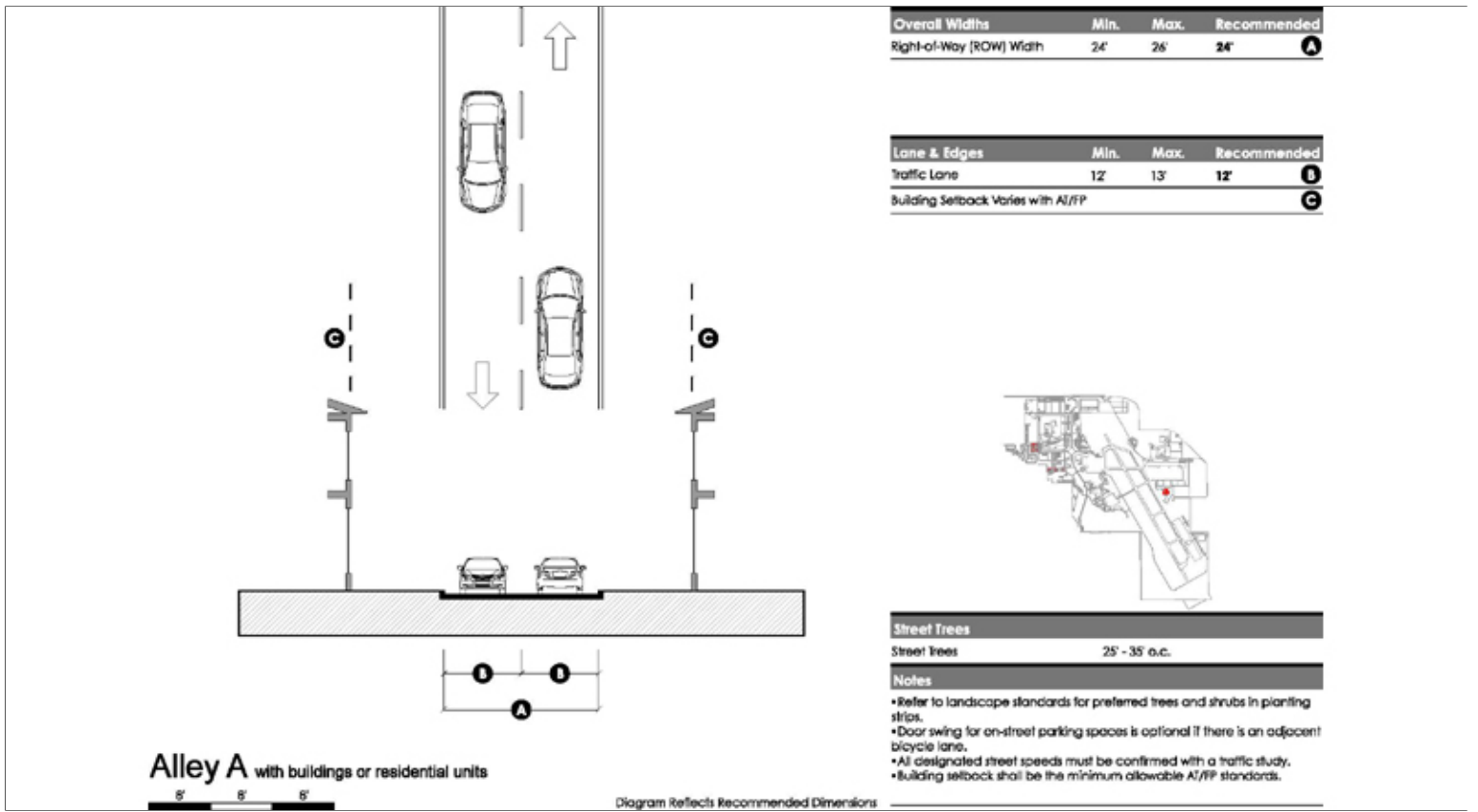

Typical Local Street Diagram - Alley A

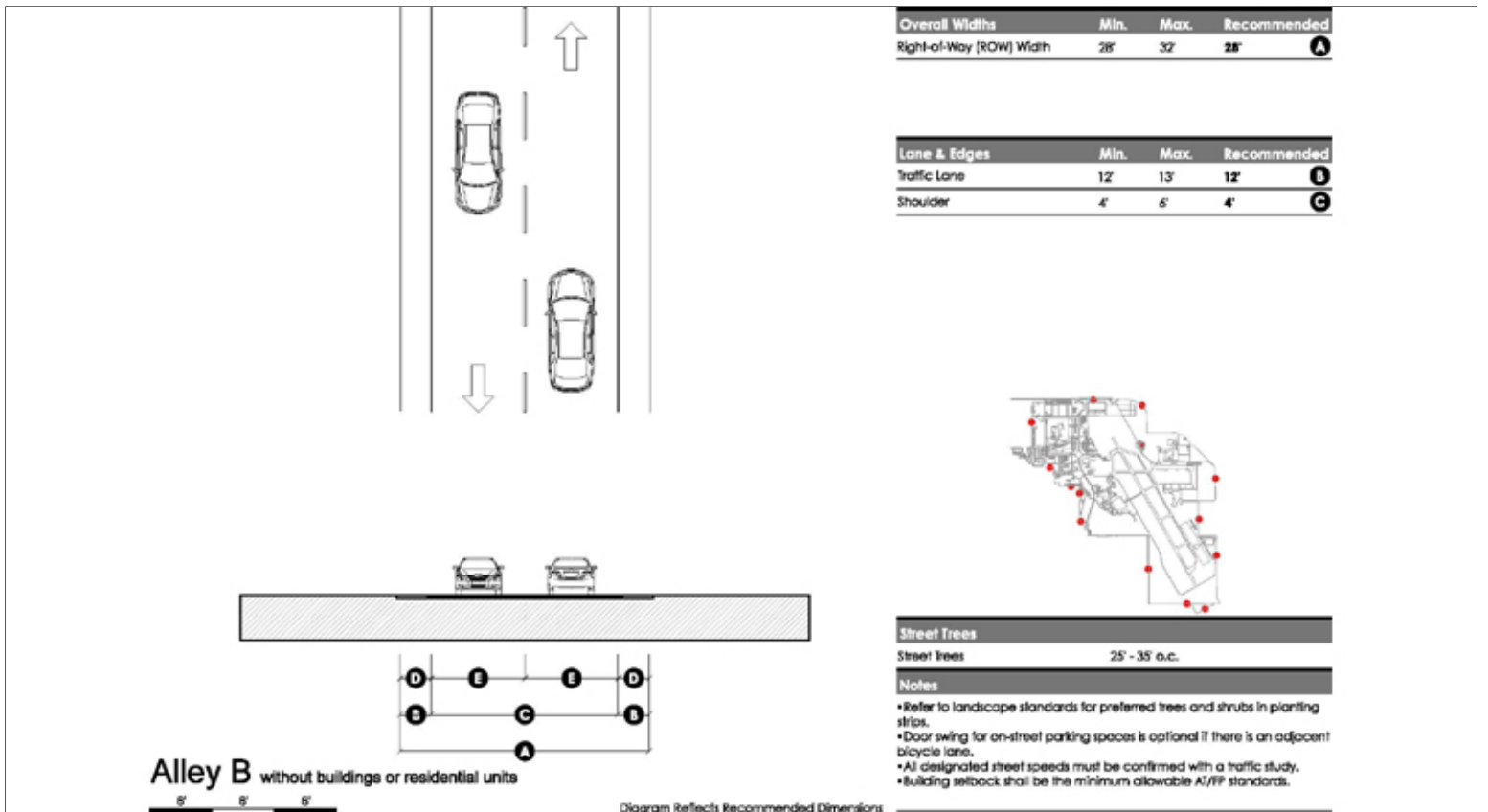

Typical Local Street Diagram - Alley B

1. Develop all special routes which are adjacent to Group 1 facilities, with a level of quality consistent with Group 1.

B02.2. Hierarchy of Intersections

Applicable N/A Select number of graphics / images (large: 800 px x 440 px) to insert 1

Image Tool 800 x 440

Applicable N/A Small graphics do not apply



Boulevard Intersection Native and Maintained Landscape

1. Provide a hierarchy of intersections to include arterial, arterial-collector, collector, collector-local and local following UFC 3-201-01 and its industry references.
2. Passive systems such as traffic circles are preferred to active systems such as signalized intersections. Aggressively pursue passive systems to lower maintenance requirements and reduce energy use.
3. Use a level of visual quality for an intersection equal to the quality found in the related streetscape, which corresponds to the adjacent Facility Group number.

B02.2.1. Arterials

Applicable N/A Select number of graphics / images (large: 800 px x 440 px) to insert 2

Image Tool 800 x 440

Applicable N/A Small graphics do not apply

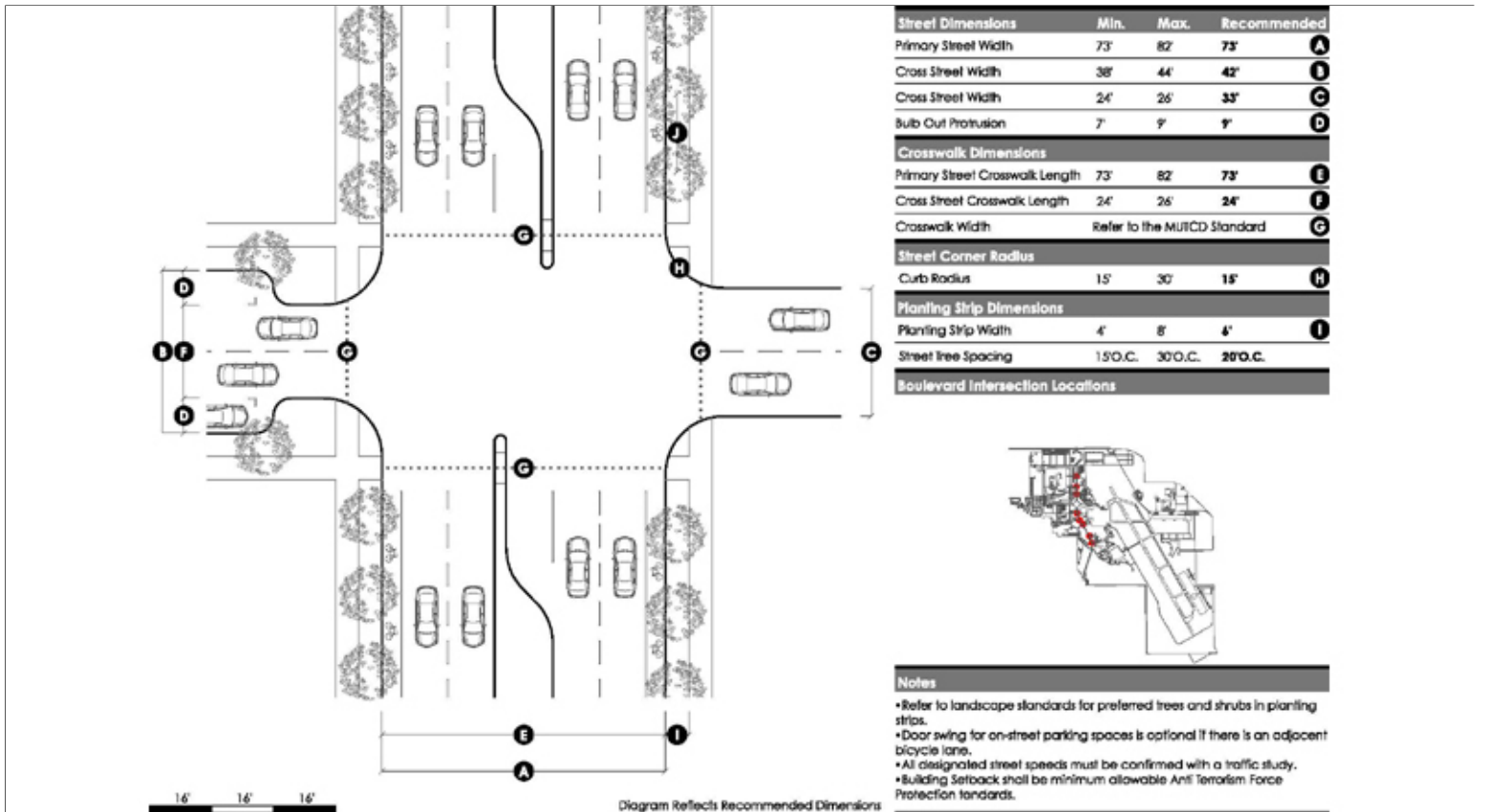

Diagram Reflects Recommended Dimensions
Typical Avenue Intersection

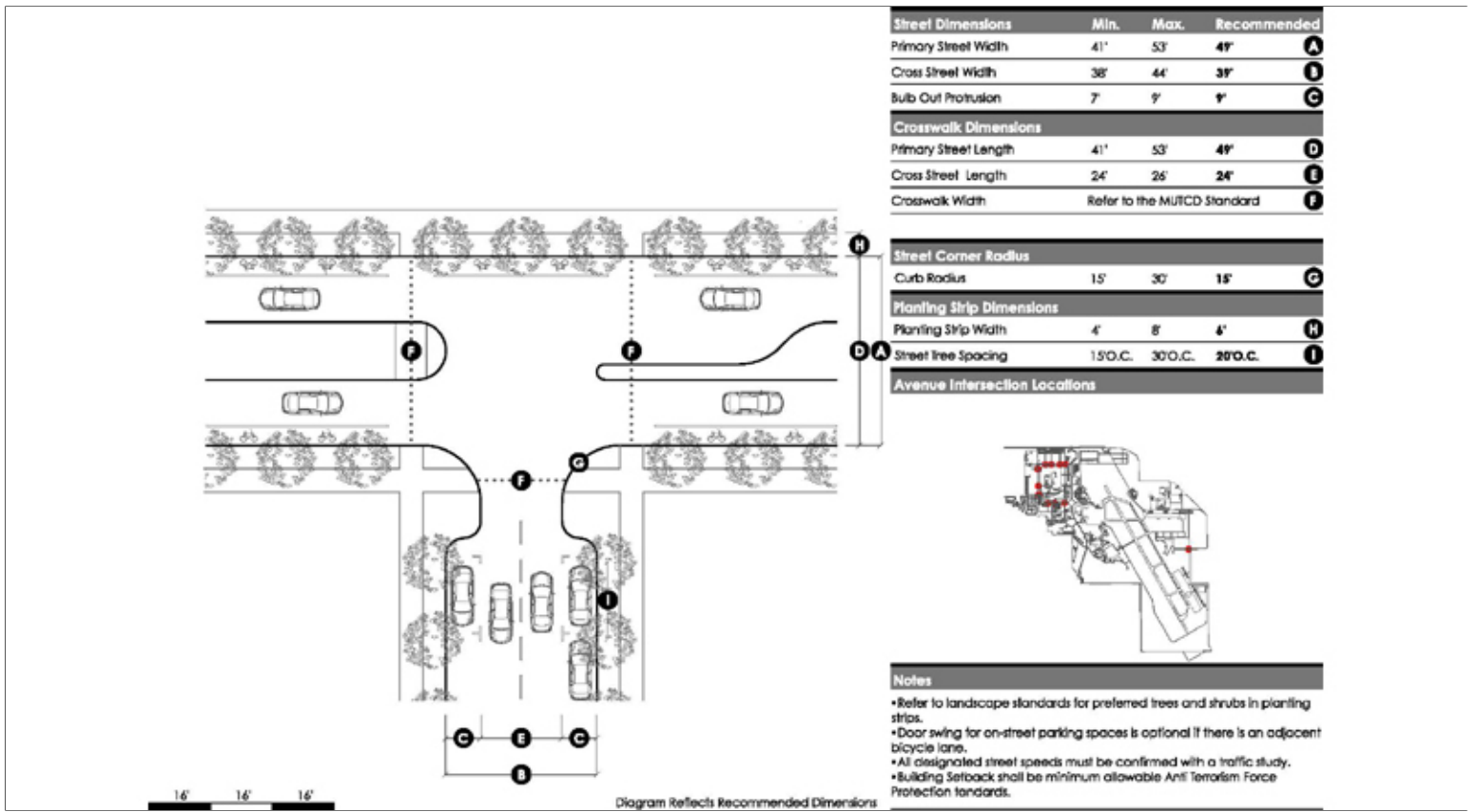

Diagram Reflects Recommended Dimensions

Typical Avenue T Intersection

1. At intersections adjacent to Group 1, landscaping of native grasses and shrubs may be provided; trees may be included when maintenance and non-potable irrigation is available. Monuments and static displays may be integrated into arterial intersection designs.

B02.2.2. Arterial/Collector

Applicable N/A Select number of graphics / images (large: 800 px x 440 px) to insert 1

Image Tool 800 x 440

Applicable N/A Small graphics do not apply

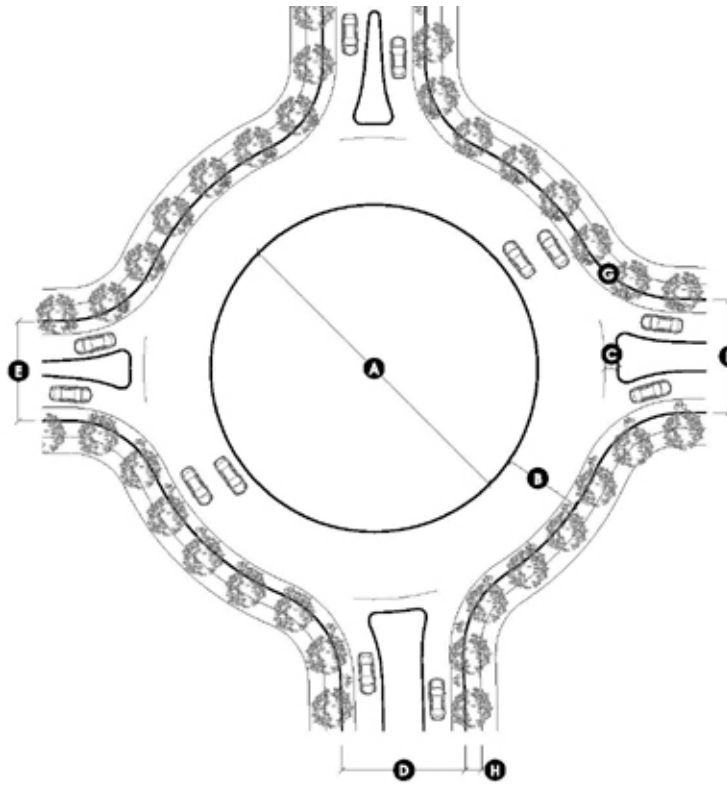

Roundabout Dimensions	Min.	Max.	Recommended	
Center Median Width	100'	140'	122'	A
Roundabout Street Width	27'	32'	30'	B
Bicycle Lane	3'	6'	8'	C
Street Dimensions				
Primary Street Width	45'	53'	45'	D
Cross Street Width	34'	38'	34'	E
Cross Street width	45'	53'	45'	F
Street Corner Radius				
Curb Radius	15'	35'	35'	G
Planting Strip Dimensions				
Planting Strip Width	4'	8'	4'	H
Street Tree Spacing	15'O.C.	30'O.C.	20'O.C.	I
One-Way Traffic Circle Locations				



Notes

- Refer to landscape standards for preferred trees and shrubs in planting strips.
- Door swing for on-street parking spaces is optional if there is an adjacent bicycle lane.
- All designated street speeds must be confirmed with a traffic study.
- Building Setback shall be minimum allowable Anti Terrorism Force Protection standards.

Diagram Reflects Recommended Dimensions

Typical One-Way Traffic Circle

1. At arterial/collector intersections adjacent to Group 1, landscaping of native grasses and shrubs may be provided; trees may be included when maintenance and non-potable irrigation is available.

B02.2.3. Collectors

- Applicable N/A Select number of graphics / images (large: 800 px x 440 px) to insert 4
- Applicable N/A Small graphics do not apply

Image Tool 800 x 440

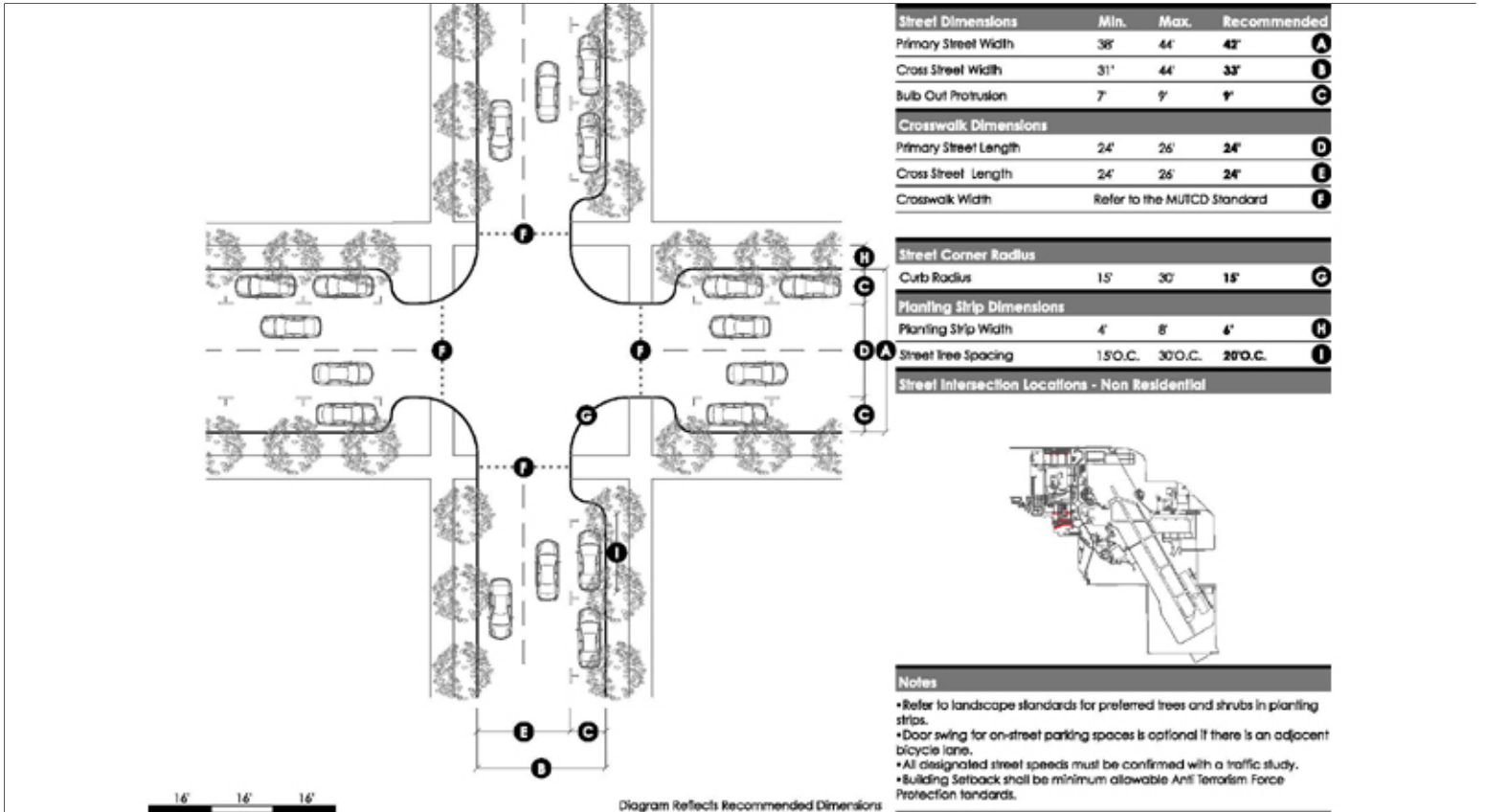

Typical Street Intersection - Non- Residential

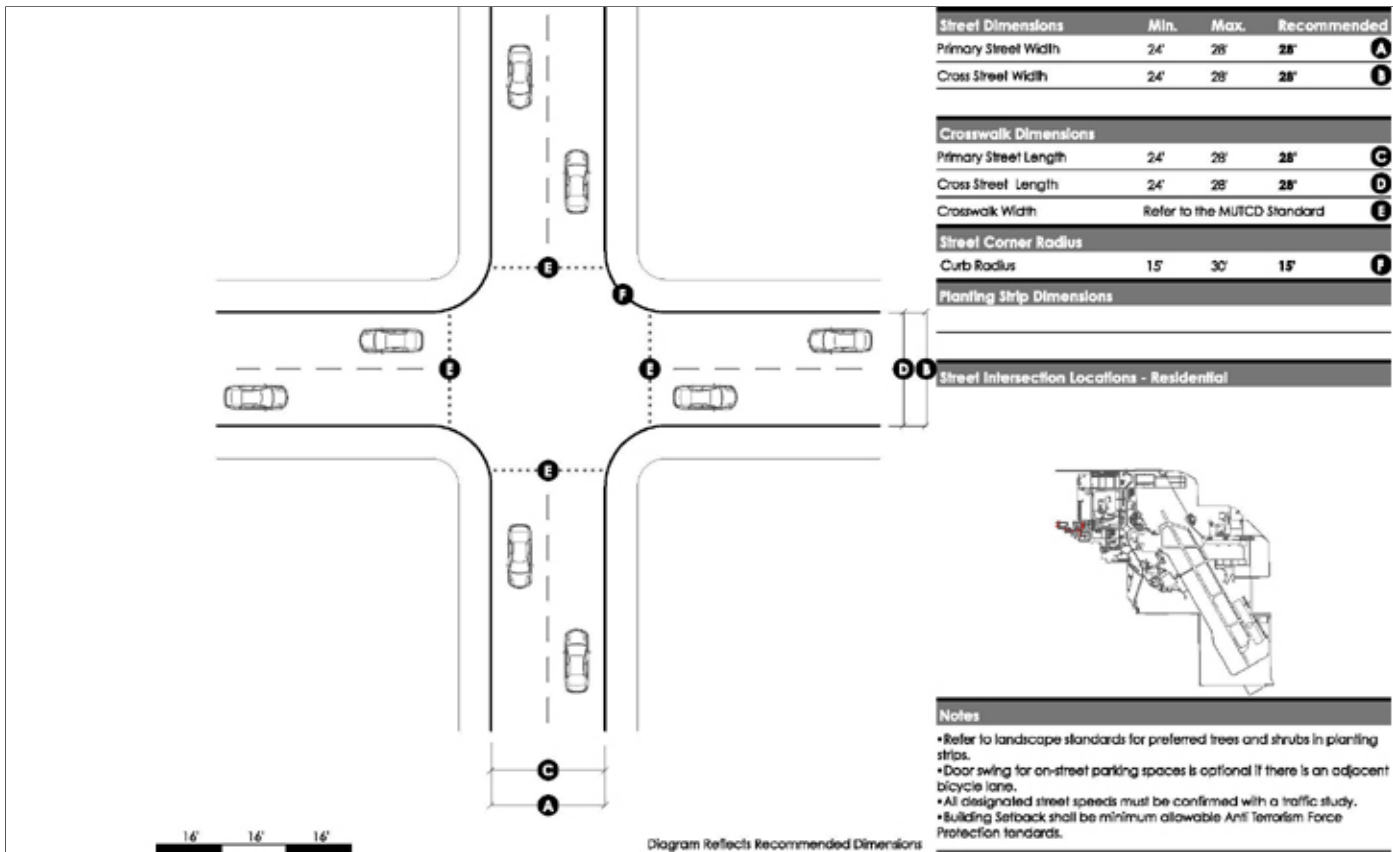

Typical Street Intersection - Residential

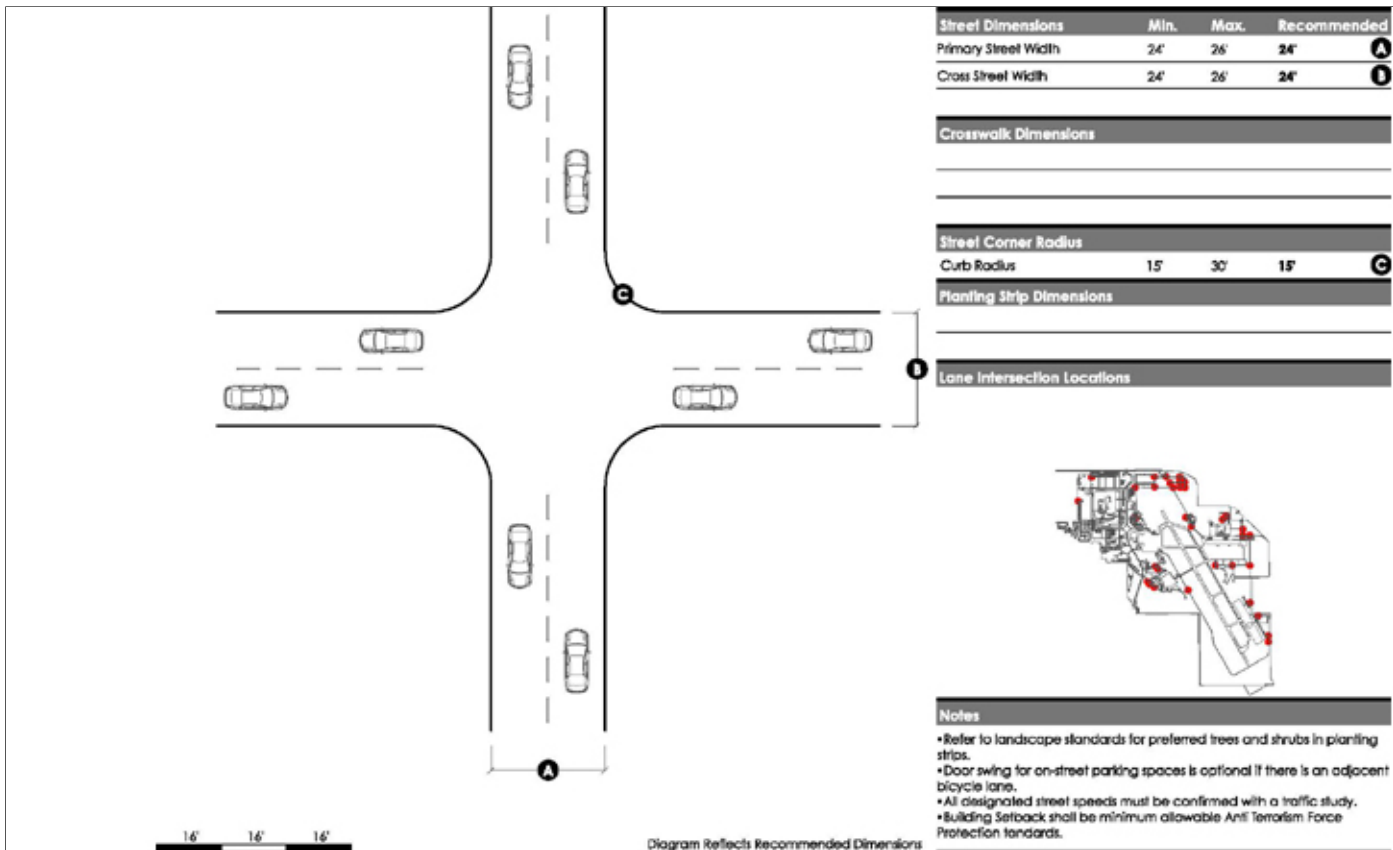

Typical Street Intersection - Group 3

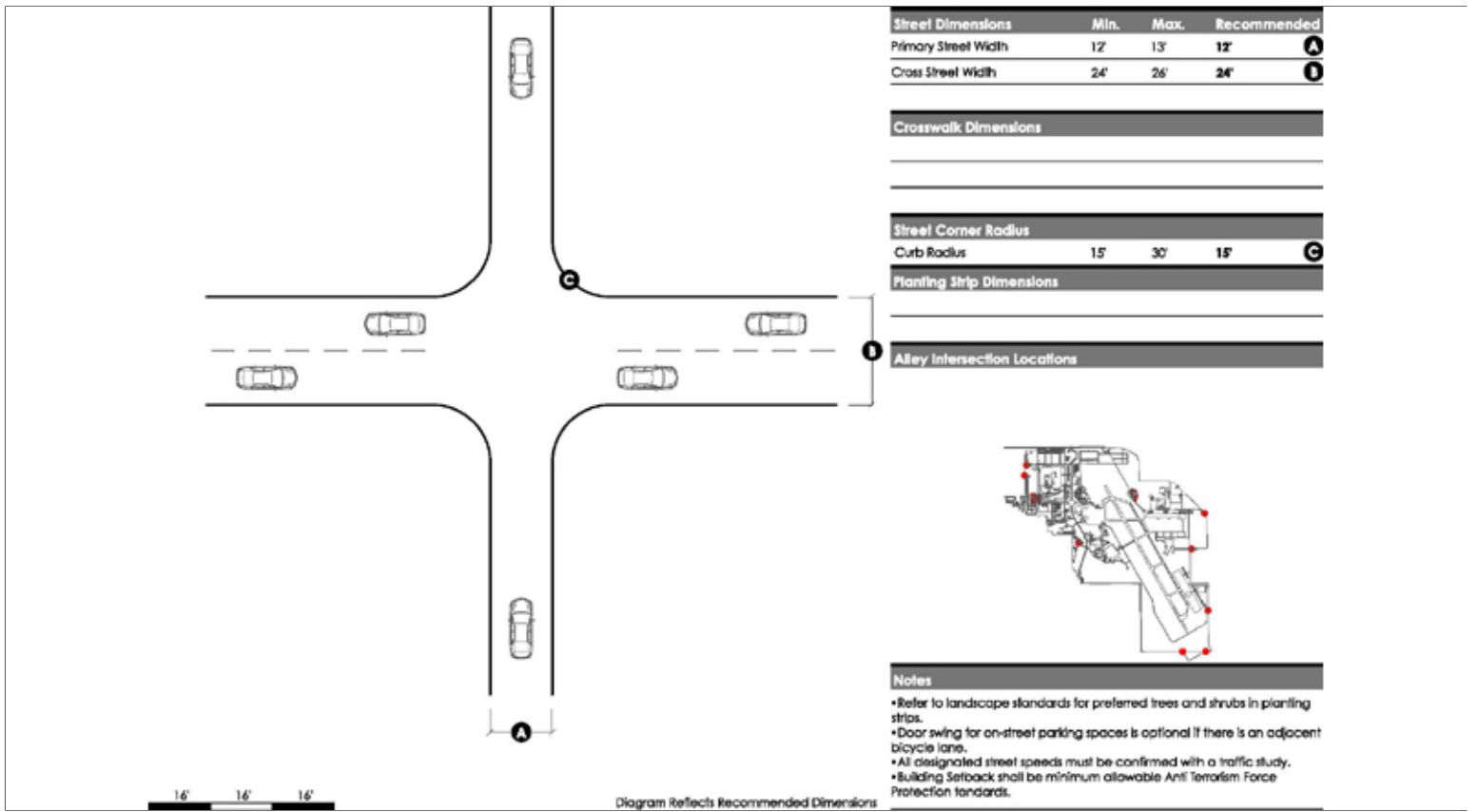

Typical Street Intersection - Remote Area

1. At collector intersections adjacent to Group 1, landscaping of native grasses and shrubs may be provided; trees may be included when maintenance and non-potable irrigation is available. Intersections adjacent to Group 2 may be developed similarly, but with less detailing.

B02.2.4. Special Intersections

- Applicable N/A Select number of graphics / images (large: 800 px x 440 px) to insert 1
- Applicable N/A Small graphics do not apply

Image Tool 800 x 440

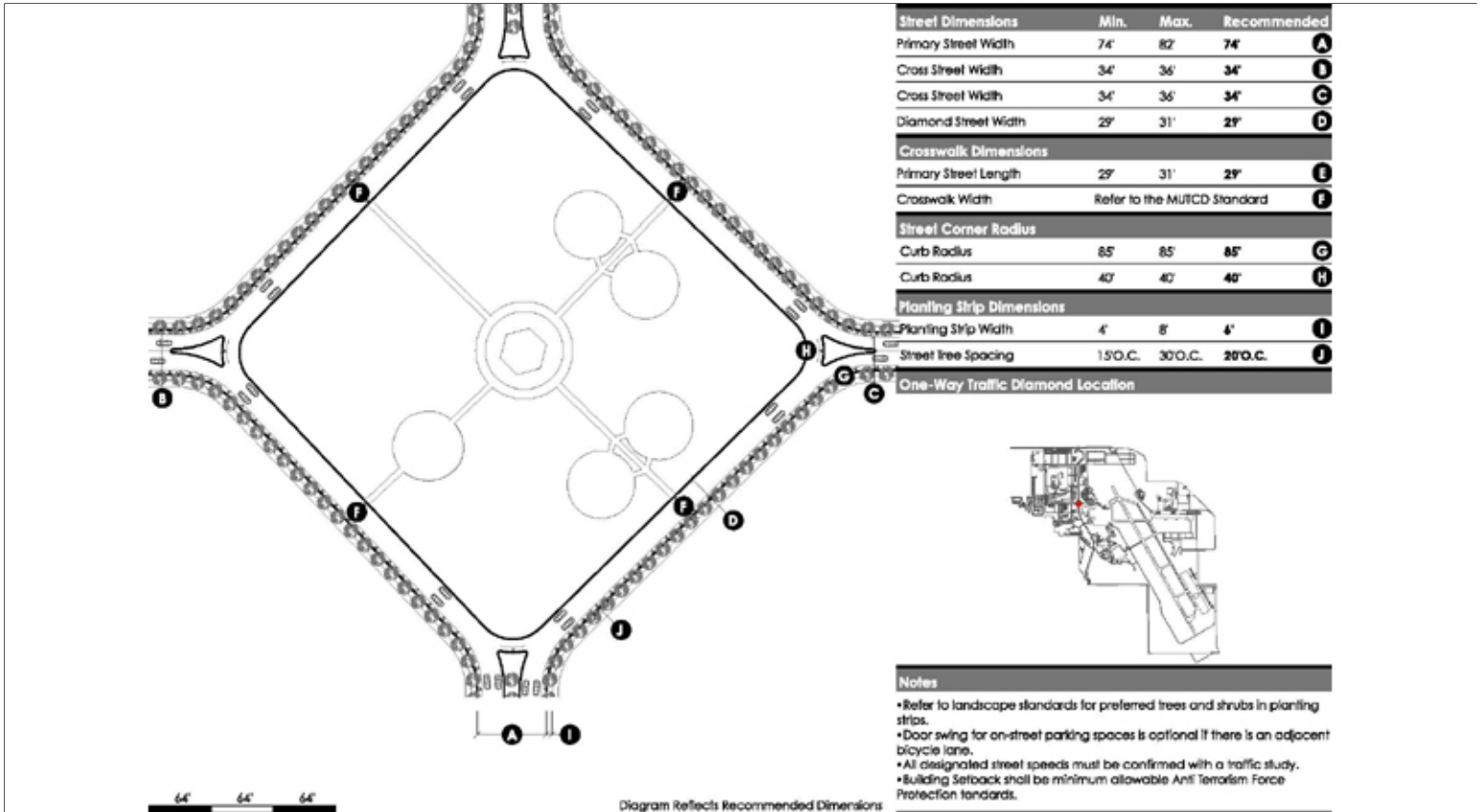

Typical One - Way Traffic Diamond

1. Develop all special intersections consistently with those adjacent to Group 1 facilities.

B02.2.5. Street Frontage Requirements

- Applicable N/A Large graphics do not apply
- Applicable N/A Small graphics do not apply

1. Consistently maintain open space buffers following B03.2.3. Preserves.
2. Refer to C06.1.7. Streetscape Landscaping for planting and screen wall requirements along street frontage.

B02.2.6. Sight Lines

- Applicable N/A Large graphics do not apply
- Applicable N/A Small graphics do not apply

1. Provide adequate sight lines for an effective and safe traffic operation per American Association of State Highway and Transportation Officials (AASHTO) standards and local municipality guidelines.

B02.3. Street Elements

Applicable N/A Select number of graphics / images (large: 800 px x 440 px) to insert 1

Image Tool 800 x 440

Applicable N/A Small graphics do not apply



Integrated Street Elements along Aspen Street

1. Emulate the streetscape area's pre-development hydrology using passive and active design features to help sustain the adjacent regionally appropriate landscape. Coordinate with the base Stormwater Management Plan.
2. Employ systems, materials and techniques to maximize streetscape sustainability. Consider pervious paving and reflectivity of surfaces appropriate for the local climate.
3. Install at-grade curbing and/or raised-profile curb and gutter as applicable to direct stormwater to bioswales and rain gardens as source water for vegetation. Do not paint concrete curbing.
4. Provide all on-site utility service lines and equipment below grade when adjacent to Facility Group 1. In routes along Group 2, 3 and 4, when mounting elements such as utility cabinets, communications equipment and water valves above grade is unavoidable, paint these consistently and provide visual screening following Installation Facilities Standards (IFS).
5. Provide traffic control devices including access control point/entry control facility signs, speed limit signs and street name signs following the current edition of the Manual on Uniform Traffic Control Devices (MUTCD) per UFC 3-120-01.
6. Follow UFC 3-120-01 for directional and wayfinding signs and address both vehicular and pedestrian traffic.

7. Reduce energy consumption and reduce maintenance requirements by providing street lighting only when functionally required to ensure safety and to address antiterrorism following UFC 4-010-01. Ensure the quality and quantities of lighting and fixtures are appropriate for the adjacent Facility Group number.

B02.3.1. Paving

Applicable N/A Large graphics do not apply

Applicable N/A Small graphics do not apply

1. Pavement design shall comply with UFC 3-250-01. Ensure appropriate analysis and design of subgrade conditions to support low maintenance high performance pavements. Apply best practices from the Construction: Seasonal Frost Conditions section of the UFC.

2. Materials for pavements shall be specified in accordance with UFC 3-250-01 and must conform to requirements set forth in the Unified Facility Guide Specifications (UFGS) for concrete and asphaltic concrete.

B02.3.2. Curb and Gutter

Applicable N/A Large graphics do not apply

Applicable N/A Select number of graphics / images (small: 250 px x 188 px) to insert 2

Image Tool 250 x 188

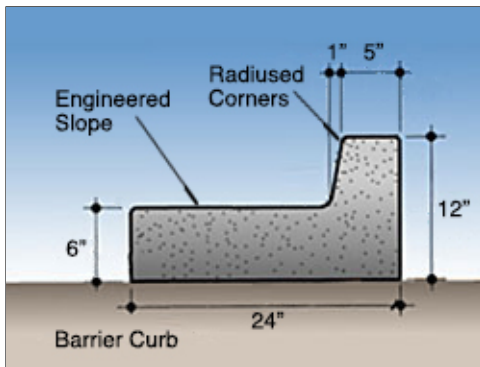

Typical Curb Section

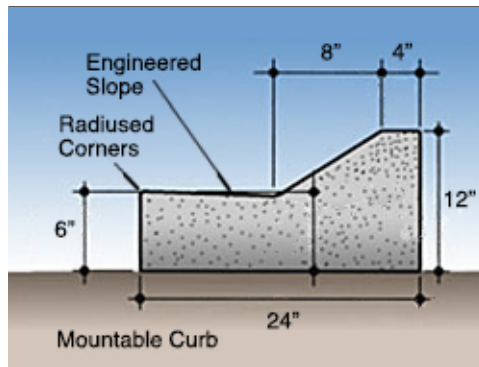

Typical Curb in Group 4

1. Continuous concrete curbs and gutters shall be provided at street edges areas of the installation to to:
 - a. Help control drainage.
 - b. Deter vehicles from leaving the pavement.
 - c. Protect pedestrians.
 - d. Delineate the pavement edge.
 - e. Present a more finished general appearance.
 - f. Assist in orderly and disciplined development of the street system.
2. Provide dimensions following the illustrations for Standard Mountable Curb, Standard Barrier Curb and Standard Header Curb.
3. Use the barrier curb design at arterial streets and at raised central medians. Use the mountable curb design at collector and local streets. Use the header curb design at locations where a permanent, finished edge is required, but where pavement drainage can flow onto adjacent areas such as bioswales and rain gardens.

B02.3.3. Utility Service Elements

Applicable N/A Large graphics do not apply

Applicable N/A Small graphics do not apply

1. Provide all utility service lines below grade when streets are adjacent to Facility Group 1; when mounting elements (such as utility cabinets, communications equipment and water valves) above grade is unavoidable, paint these consistently and provide visual screening following Site Development, Landscaping.
2. Overhead service lines along streets adjacent to Facility Groups 2, 3 and 4 are discouraged.

B02.3.4. Traffic Signs

Applicable N/A Large graphics do not apply

Applicable N/A Small graphics do not apply

1. Refer to Exterior Signs, Colors and Types for Traffic Control Devices, which includes signs.

B02.3.5. Street Lighting

Applicable N/A Large graphics do not apply

Applicable N/A Small graphics do not apply

1. Refer to the Lighting section for appropriate applications along streets.

B02.3.6. Other

Applicable N/A Large graphics do not apply

Applicable N/A Small graphics do not apply

B03. OPEN SPACE / PUBLIC SPACE

Comply with Air Force Corporate Standards for Installation Elements:

<http://afcfs.wbdg.org/installation-elements/index.html>

Comply with AF Corporate Standards for Open Space / Public Space:

<http://afcfs.wbdg.org/installation-elements/open-space-public-space/index.html>

B03.1. Plazas, Monuments and Static Displays

Applicable N/A Large graphics do not apply

Applicable N/A Select number of graphics / images (small: 250 px x 188 px) to insert 3

Image Tool 250 x 188



Concrete Paving at Plaza



Pavilion and Plaza



Plaza at Entrance

1. Natural features and culturally or historically significant features or events may be recognized and acknowledged with physical elements such as plazas, monuments and static displays. However, limit these elements on the base to ensure judicious use of resources and to reduce ongoing maintenance requirements.
2. Design highly durable plazas, monuments and static displays with a level of quality comparable to Facility Group 1.
3. Link plazas, monuments and static displays to the pedestrian circulation system. Install landscaping, site furnishings and lighting appropriate for the application and local climate following Installation Facilities Standards (IFS).
4. Select systems, products and materials for paving, walls, and structures following IFS.

B03.1.1. Paved Plazas

Applicable N/A Large graphics do not apply

Applicable N/A Small graphics do not apply

1. Mitigate heat island by providing high-albedo, shaded plazas. Pervious pavers shall be used on all plazas and courtyards in Facility Groups 1 and 2; use pervious concrete in Groups 3 and 4. The designer shall incorporate appropriate expansion and construction joints.
2. Pavers shall match the color of pavers used on adjacent sidewalks using base standard range of beiges, tans, browns, or terra cotta. Bricks used on plazas shall typically be 4" x 8" size.

B03.1.2. Sculptures, Markers and Statuary

Applicable N/A Large graphics do not apply

Applicable N/A Small graphics do not apply

1. Relate new sculpture, markers and statuary to the base's architectural design theme. Generally limit these elements to frequently used locations adjacent to Facility Group 1 and highly traveled community pedestrian spaces.

2. Consider entry gates as possible sites for new displays.
3. All proposed memorials shall follow AFI 36-3108 and be limited to highly deserving individuals or groups as deemed appropriate by the installation leadership. Living memorials (tree plantings / etc.) are discouraged due to added maintenance requirements.
4. When sculpture requires a base, match the materials and / or color palette of adjacent buildings.
5. Use direct or indirect lighting to accentuate features or enhance an intended effect.
6. Ensure that all sculpture, markers and statuary are honorable and inspiring, provide a sense of place, positively contribute to the base's visual quality, and encourage pride for the community and the US Air Force.

B03.1.3. Static Display of Aircraft

Applicable N/A Large graphics do not apply

Applicable N/A Small graphics do not apply

1. Follow IFS base-wide standards for all elements of the display area with specific attention to traffic sight lines, pedestrian circulation, site furnishings, signs, and lighting. Address requirements for the Facility District as well.
2. Generally locate concrete base/foundation structures for static displays below grade.
3. At static displays where pedestrian paths are provided, a minimum of one trash receptacle and one bench shall be provided. Receptacle and bench design must conform to IFS requirements.

B03.2. Grounds and Perimeters

Applicable N/A Large graphics do not apply

Applicable N/A Small graphics do not apply

1. Provide formal spaces for parade and review functions, recreational areas and parks following the base's Installation Development Plan (IDP) and Installation Facilities Standards (IFS). Refer to the Site Furnishings topic for additional information.
2. Maintain preservation areas following the IDP and IFS.
3. Comply with UFC 4-010-01 DoD Minimum Antiterrorism Standards for Buildings and UFC 4-022-03 Security Fences and Gates for all elements associated with the base's gates and perimeter fence.
4. Identify and describe base-wide utility corridors in the IDP.
5. Base-wide utility infrastructure shall be inconspicuous. Bury utility service lines below grade when adjacent to Facility Group 1 and when economically feasible for Facility Groups 2, 3 and 4. When service lines are located above grade, create an ordered, coordinated appearance.
6. Follow the requirements of this IFS regarding all utility structures and service lines located above grade that visually impact the installation.
7. Where screening of utility equipment and structures is provided, allow adequate and proper clearance for safety and maintenance.
8. Reduce visual clutter and visual impact of the following items through a combination of careful placement, screen walls, landscaping and painting:

- Electrical switch-stations.
 - Sewage lift stations.
 - Water well pumps, storage tanks and/or related structures.
 - Gas piping, meters and similar incidental items.
 - Above ground fuel storage tanks.
 - Any ground-mounted freestanding utility item exposed to view.
9. Larger structures such as electrical switch-stations, sewage lift stations, fuel storage tanks and mechanical/electrical equipment shall be screened from view, using materials, forms, and colors in the screen walls which match those respective design elements present at adjacent buildings.
10. Paint above-ground equipment and associated components such as electrical piping or exposed plumbing lines dark bronze.
11. Maintain currently buried utility service lines as a visual asset.
12. Bury the following exposed above-grade items in future projects when economically feasible:
- Electrical power grid and service lines.
 - Telephone lines.
 - Cable TV lines.
 - Communications lines.
 - Exterior lighting service lines.
 - Any similar system of above-ground lines serving the base.
13. Consolidate and enclose service utility lines in underground utility corridors when feasible. Create routes along the inside edge of parking lot islands.

B03.2.1. Parade Grounds

Applicable N/A Large graphics do not apply

Applicable N/A Small graphics do not apply

1. Follow UFC 3-201-02, Appendix B for the planning and design process and criteria for parade grounds.
2. Establish and maintain parade grounds only where there is a confirmed need and provide landscape materials appropriate for the locale following IFS.
3. Bleachers may be installed only when there is a documented requirement at parade grounds. Nonferrous metals that do not require painting or going maintenance are preferred. The Base Civil Engineer shall determine quantities, sizes, and products on a case basis.

B03.2.2. Parks

Applicable N/A Select number of graphics / images (large: 800 px x 440 px) to insert 1

Image Tool 800 x 440

Applicable N/A Small graphics do not apply

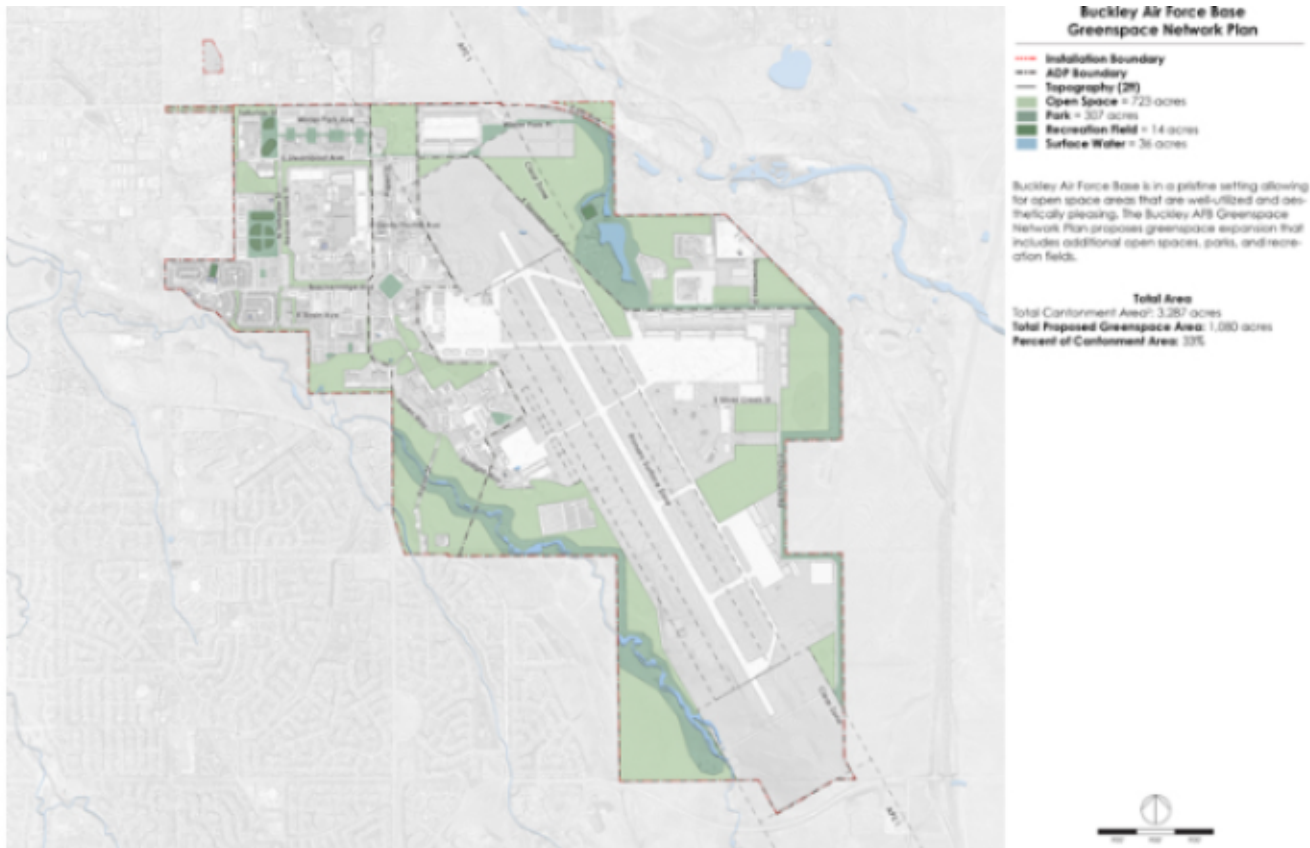

Buckley Air Force Base Greenspace Network Plan

1. Bleachers may be installed only when there is a documented requirement at parks and fields for recreational events. Follow guidance under Parade Grounds.
2. Picnic pavilions may be provided in parks where there is a documented need.
3. Prohibited picnic pavilion materials include wood, concrete masonry units (CMU) or metal pre-manufactured storage sheds.
4. When picnic pavilions are permitted near facilities, generally match the architecture of the adjacent facility and provide a level of quality of the adjacent facility group number.
5. Refer to graphic B03.2.2.1 for Parks and Recreation Field locations.

B03.2.3. Preserves

Applicable N/A Large graphics do not apply

Applicable N/A Small graphics do not apply

1. Preserve open space buffers along the installation's boundaries on the west, north and east to satisfy Force Protection requirements and to provide visual and physical relief from adjacent properties.

2. Preserve the following areas to prevent further development:
 - a. The land along each side of Aspen St in the Aspen ADP.
 - b. The linear open space along East Toll Gate Creek
 - c. All areas designated as open space in IDP. Refer to graphic B03.2.2.1 for open space designations.

3. Aspen Street, which has been designated as part of the Major Corridor Open Space Preserve, shall have varying overall widths as defined in the Installation Development Plan. The following specific buildings are listed as establishing setback lines:
 - a. Building 1030 and Building 1032 west of Aspen Street.

4. The following specific requirements shall be incorporated into all project designs within the Aspen Street Corridor Open Space Preserve:
 - a. Buildings of any size or kind shall not encroach into the preserve at any point. Existing buildings in the preserve, such as Building 1470, may remain. Small additions onto existing buildings may be permitted, provided the overall square footage (footprint) does not exceed 2,000 square feet at each existing building, and providing that the open nature of the preserve is not compromised.
 - b. All parking lots should be located outside the preserve, except that no part of any parking lot can be located less than fifty feet (50') from the curb at the adjacent street edge of Aspen Street. Parking lots located in the preserve shall typically be located toward the outer edges (setback line) of the preserve, and must incorporate special landscaping and screen walls as described in Section 5.7 - Parking Lot Landscape.
 - c. Along both sides of Aspen Street, provide a row of Norway Emerald Queen Maple trees, spaced thirty feet (30') on center. The trees shall be lined up both along the street and laterally (across the street) to provide a uniform, rhythmic and formal visual effect. These trees shall be located in the divider strips or on the backside of the sidewalks if divider strip is too small or non-existent.
 - d. In the central median, provide a minimum of one (1) Honey Locust (If median is a minimum of 10' wide) for every one hundred feet (100'), and fraction thereof. Install low story shrub material not exceeding 30" in height throughout median. If central median is between 6-10' wide - use only shrub material. If under 6' wide - follow the stamped concrete detailing. Trees and shrubs may be grouped to accommodate Aspen Street. streetscape traffic safety requirements (sight visibility triangles). A concrete surface may also be used behind the curb as a splash plate to provide protection from snowplows and chemicals associated with snow removal.
 - e. Kentucky Blue Grass is currently the principal ground plane material, but should be removed and renovated over time to low water shrubs in wood mulch beds. Rock mulch should also be added at narrow parkway areas & at median nose points where it is inefficient to maintain grass or plant material and to help break up planting beds.

5. Maintain the park-like appearance of the Major Boulevard corridor area. If there is an encroachment within the setback area, screening along the street frontage will be made up of a solid screen/ retaining wall, berming, and shrubbery.
 - a. The solid screen wall shall be at least four feet (4') high and shall be constructed using the predominant building materials of the character area.
 - b. Berming should cover at least three feet (3') of the solid screen wall and is intended to be gradual with slopes not exceeding 3:1.
 - c. Shrubby located along the edge of the solid screen wall should be provided for additional softening and screening. Provide 1 shrub per 5 lineal feet of frontage. Shrubby should be laid out in groupings or masses at the perimeter of the lot area. Shrubby should not necessarily be evenly spaced or distributed along this edge. At least 60% of these plant materials must be evergreen.

In addition to these screening requirements, the balance of the parking area that encroaches into the open space preserve must meet more stringent requirements of increased interior area and parking lot tree quantities.

B03.2.4. Perimeter Fence

Applicable N/A Large graphics do not apply

Applicable N/A Small graphics do not apply

1. Design, install and maintain the base's perimeter fence following UFC 4-022-03.

2. Stringently comply with ATFP requirements following UFC 04-010-01 for all spaces adjacent to the base's perimeter fence and all gates.
3. Fencing, gates and other elements that are associated with the main gates shall be a level of quality equivalent to Facility Group 1.
4. Maintain a positive visual quality along the traffic corridor on both sides of the main gates. Specifically address pedestrian access, circulation and common areas.

C. SITE DEVELOPMENT

Comply with Air Force Corporate Standards for Site Development:
<http://afcs.wbdg.org/site-development/index.html>

C01. SITE DESIGN

Comply with Air Force Corporate Standards for Site Development:
<http://afcs.wbdg.org/site-development/index.html>

Comply with AF Corporate Standards for Site Design / NEPA:
<http://afcs.wbdg.org/site-development/site-design-nepa/index.html>

C01.1. Site Design Considerations

Applicable N/A Select number of graphics / images (large: 800 px x 440 px) to insert 1

Image Tool 800 x 440

Applicable N/A Select number of graphics / images (small: 250 px x 188 px) to insert 6

Image Tool 250 x 188



Gathering Place and Pavilion at Group 3



Group 1 Entrance Grounds



Alignment with Entrance



Adjacent Parking Area



Integrated Xeric Planting



Plaza and Pavilion at Group 3



Native Grasses at Group 2

1. Collect documentation to validate approvals and completion of the NEPA process.
2. Ensure site design compliance with the Installation Development Plan (IDP) and its component plans and Installation Facilities Standards (IFS).
3. Promote integrated design with on-site solutions such as engineered small-scale hydrologic controls versus base-wide infrastructure; consider open space, natural features, bioswales, building roofs, streets, and paved surfaces.
4. Limit the impact of development on land and water resources. All site elements and infrastructure shall reinforce an image of sustainability, with reduced energy demand, renewable-energy usage, and water conservation.
5. Consider energy conservation during site design for the following categories: building and site lighting, auxiliary systems and equipment (refrigerators, elevators, etc.), building envelope, electric power and distribution, HVAC systems and equipment, service hot water, energy management (metering, EMCS).
6. Coordinate on-site renewable-energy systems and components to minimize area requirements and maximize efficiencies. Appropriately buffer and screen these and other mechanical systems and equipment.
7. New building projects should preserve open space and protect natural habitat.
8. Conform to existing topography to the greatest extent possible and use slopes to increase site and building efficiencies. Design sites to minimize irrigation and impacts to stormwater runoff.
9. Carefully study new project sites to identify the character of adjacent buildings, streets, landscaping, and site design elements. Reinforce the existing character in new site design.
10. Consider relationships to adjacent facilities and district / centralized heating and cooling infrastructure and cost effectively connect building systems to harvest heat, grey water or other beneficial byproducts.
11. Minimize existing and planned obstructions from landscaping, structures, topography, and adjacent developments to preserve solar access and natural ventilation.

12. Purposefully integrate service access, receiving and storage areas to eliminate the need for visual screening.
13. Appropriately connect to the base network of streets, sidewalks and trails using drive aisles, parking areas, walkways, paths, and bicycle routes addressing both vehicles and pedestrians.
14. Applicably coordinate heat island mitigation in paving and roof designs when implementing an integrated approach to stormwater management.
15. Consider the location of "Designated Tobacco Areas."

C01.2. Building Orientation

Applicable N/A Select number of graphics / images (large: 800 px x 440 px) to insert 1

Image Tool 800 x 440

Applicable N/A Select number of graphics / images (small: 250 px x 188 px) to insert 6

Image Tool 250 x 188

DRIVING FACTORS

- | | | | |
|--|--|--|---|
| • Optimal solar orientation of the building. | • Maximize the daylight & desirable views. | • Meet the required AT/FP standoff distance | • Create a unified campus |
| • Main entrance from Pepperrell street. | • Saving existing vegetation and trees | • Separation between staff/public/materials entrance | • Outdoor healing environment |
| • Addressing the orientation of the future ACC | • Visibility of the new facility from main roads | • Required parking spaces for public and staff | • Implementation of landscape zones A, B, C & D |

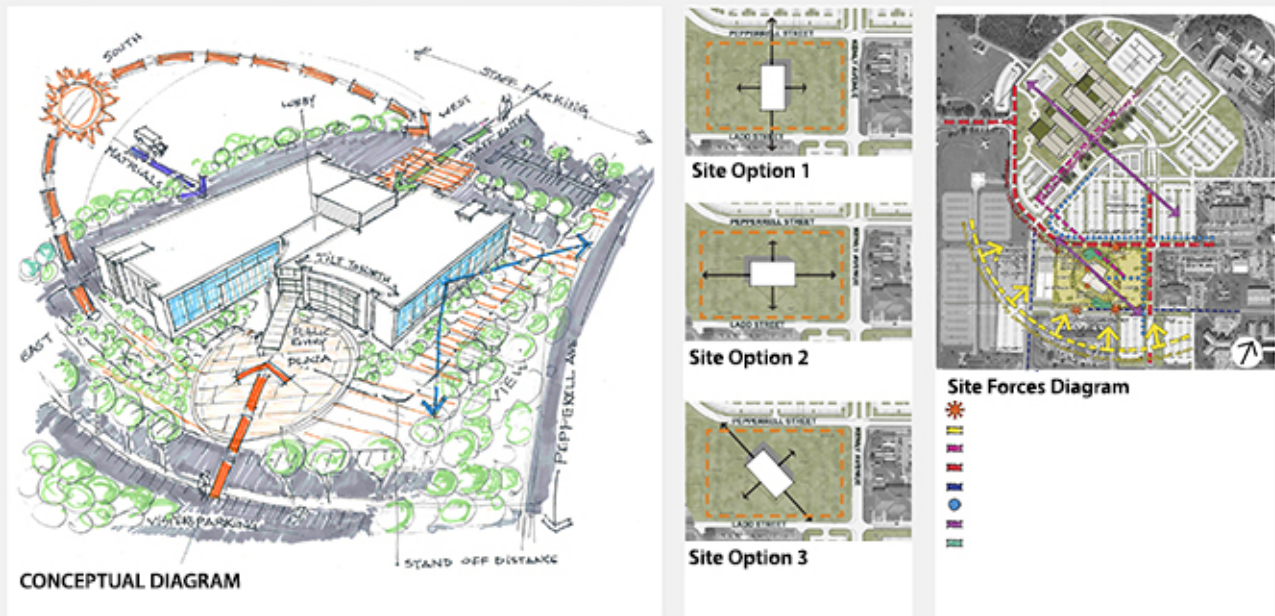

Conceptual Site Analysis and Site Design Diagram

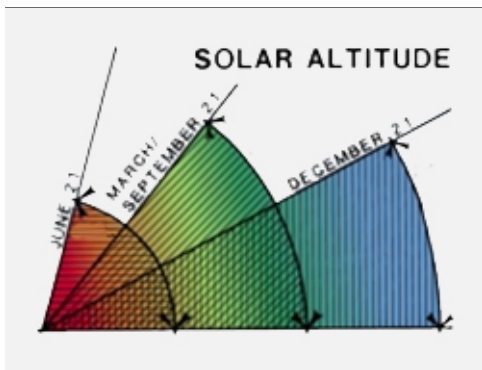

Local Solar Data

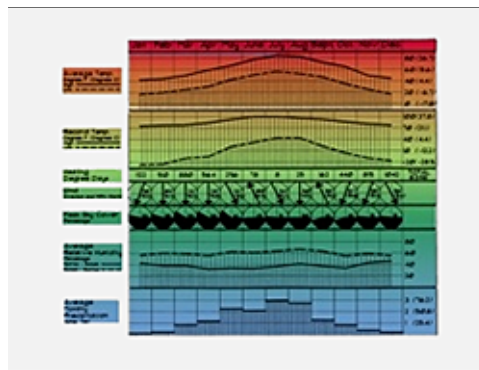

Local Climate Data

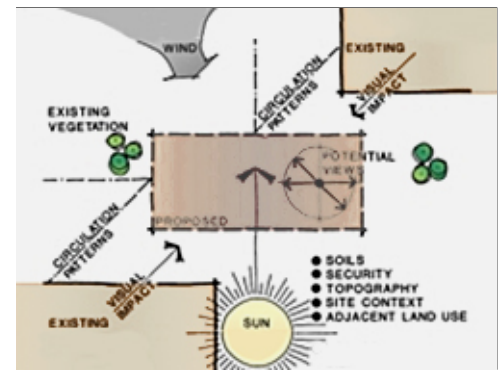

Site Data

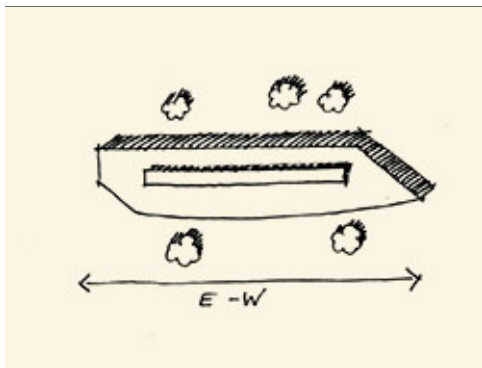

East-West Axis

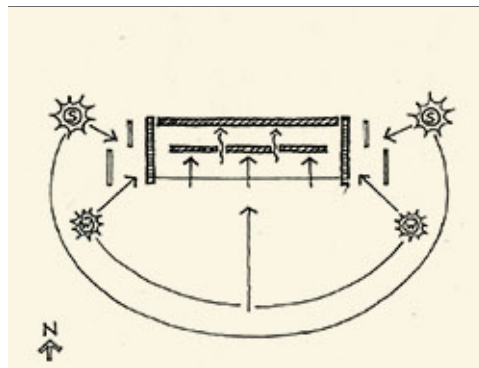

Optimum Solar Control

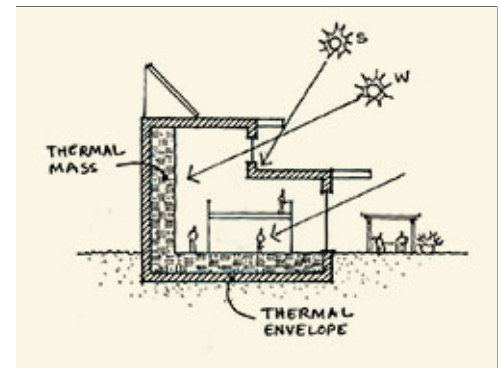

Optimized Shading

1. Ensure the site will accommodate optimum requirements for building orientation, which is with the long axis parallel to the east/west direction for rectilinear CONUS buildings.
2. Meet Installation Facilities Standards (IFS) requirements for the locations of the building's passive and renewable-energy systems --including geothermal and solar systems --and exterior shading systems.
3. Locate the building(s) and permitted ancillary structures to promote solar gain, solar shading, natural ventilation, rainwater harvesting, wind buffering and other beneficial passive systems. Consider natural ventilation during the design of HVAC systems.
4. Consider relationships to adjacent sites and their facilities and infrastructure, and cost effectively integrate building systems to harvest heat, grey water or other beneficial byproducts.
5. Consider the "public side" of the building, its views and the location of the main entrance.

C02. UTILITIES

Comply with AF Corporate Standards for Site Development:

<http://afcs.wbdg.org/site-development/index.html>

Comply with AF Corporate Standards for Utilities:

<http://afcs.wbdg.org/site-development/utilities/index.html>

C02.1. Utility Components

Applicable N/A Large graphics do not apply

Applicable N/A Select number of graphics / images (small: 250 px x 188 px) to insert 3

Image Tool 250 x 188



Buried Utilities at Group 1



Pad Mounted Cabinet at Group 3



Hydrant at Group 2

1. Electrical Utility Requirements: The electrical power provider for the Base is Xcel Energy. A 13.2/7.60kv y feeder system north of the Base provides the majority of power for BAFB. The BAFB electrical distribution system consists primarily of a concrete-encased duct bank with pad mounted switches for feeder selection and interruption. The electrical system capacity, as determined by the capacity of the parallel #4/0 MV-105 feeder conductor from the primary switch station, is 630A at 13,200/7620 volts grounded y system, or 13.6 megavolt-amperes (MVA). The system is radial in nature. While there is no loop around the airfield the main Base has three main loops for security reasons. Most of the Base transformers are pad mount type and are installed adjacent to buildings. The following items shall be used as a checklist or guide for the Medium Voltage Electrical Distribution System in addition to the publication and documents referenced above:
 - Coordinate Electrical Distribution design and construction with all other site utility systems both horizontally and vertically to avoid conflicts.
 - Currently, a base wide electrical distribution and coordination study is not available. Each project shall have building loading and coordination studies submitted for Base review and verification of available capacity.
 - Wherever possible, existing overhead power lines should be installed underground, including new and existing lines. Priority should be given to areas where safety may be enhanced- schools, housing areas, etc.
 - Provide standard 8' x 8' x 8' octagonal concrete Amcor vault or equal for tying into the site electrical distribution system.
 - Ensure all splices and bushings are torqued to manufacturer's specifications.
 - Medium Voltage Distribution: Site electrical distribution system is a 13,200/7620 volts grounded y system. Provide medium voltage cable and step-down transformer to provide 480/277 volt grounded y system at each facility. Primary transformers will be dead front with feed through primary, multi-tap at 2.5% taps, switched, copper wound, and bolted to the concrete pad. Perform an acceptance test on all primary transformers prior to energizing. Perform hi-pot testing on all cables and terminations and submit results to Base Electrical Engineer for approval prior to energizing. Contractor must supply all testing documentation of all medium voltage equipment to Base Electrical Engineer prior to final energizing and acceptance of the project.
 - Ensure 4/0 bare copper counterpoise conductor is installed above all concrete encased PVC duct systems.
2. Incoming power shall be stepped down from 13,200/7620 volts to 480/277 volts at the building service entrance. Large HVAC equipment will be powered using 3-phase, 480 volts. Lighting will be powered using 277 volts. Inside the building, power shall be stepped down from 480/277 volts to 120/208 volts for branch power.
3. Use all grounding electrodes available - as stated in the latest issue of NFPA 70, article 250 including, but not limited to, the following: Ground Rod - All ground rods shall be a minimum ¾ x 10 feet; water pipe, metal building, frame, rebar, etc.
4. Install a ground bar in every electrical room.
5. Emergency Back-Up Generator: Coordinate with BFAB to determine whether a emergency back-up generator is required for the facility. Micro Turbines should be considered for back-up power.

6. Uninterruptible Power System: It is necessary for redundancy, that mission critical facilities with a Utility Reliability Requirement (URR) of .99999 use a parallel redundant UPS configuration. This configuration electrical ties two or more UPS modules in parallel. Should one of the UPS modules in this configuration fail the remaining module(s) should be capable of supporting the full rated load without interruption to the mission. Mission critical facilities with a URR of .9999 shall also use the parallel redundant configuration when practical or a parallel non-redundant configuration where the system will support the typical load if one of the UPS module(s) should fail. A reverse transfer (single UPS) configuration is suitable for other mission critical facilities.
7. UPS Battery Strings: To eliminate single point failures in facilities with a URR of .99999 or .9999 parallel battery strings must be used. The capacity of each string must support the full rated load for the amount of time necessary to prevent interruption to the mission. If it is necessary that the mission be provided power in excess of 15 minutes, emergency back-up generation should be incorporated into the system.
8. UPS Battery Management/Monitoring Systems: Battery management/monitoring systems will greatly increase the life of a battery and reduce man-hours associated with the maintenance of the battery strings. Along with monitoring performance data during discharge the battery monitoring system should, at a minimum also monitor, float voltage, individual cell voltage, ambient temperature, cell to cell/connection resistance, and internal impedance (valve regulated batteries only). A battery management/monitoring system is recommended in all UPS battery configurations.
9. UPS Remote Monitors: Whenever UPS modules cannot be directly monitored a remote monitor system must be installed to provide operators immediate information on the condition of the UPS. The remote monitoring system shall provide the same information monitored by the battery management system.
10. UPS Maintenance Bypass Switchgear: It is necessary to install Maintenance Bypass Switchgear to facilitate maintenance and repair and reduce requiring extended mission downtime. The installation of this switch allows a technician to electrically remove the UPS from the load for preventative maintenance and trouble shooting thereby avoiding frequent and extended breaks in power. When practical, the Maintenance Bypass Switchgear should be on of the Make-Before-Break type to further prevent interruptions in power. Maintenance Bypass Switchgear is recommended for all UPS configurations.
11. UPS Load Banks: To complete annual maintenance on UPS modules a load bank must be made available to the technician performing the maintenance. The load bank must be rated a minimum of 105% of the rated load of the largest UPS module in the system if the system UPS modules can not isolate for testing than the load bank must be sized for the system's load. It is recommended that facilities with a URR requirement have a load bank dedicated to the UPS systems, preferable permanently installed. If a load bank is not permanently installed, provisions must be made to have a portable load bank available as needed for maintenance and trouble-shooting.
12. Electrical Rooms: Electrical rooms are dedicated for electrical equipment. Locate the electrical room so that it will not be placed under restrooms, drains, etc. No piping, including roof drain leaders, other than sprinkler piping dedicated to the room shall be routed through these spaces. Electrical rooms shall be heated and have direct outside access. Electrical rooms are requested to have card access.
13. Provide transformers per Air Force AFJMAN 32-1080 Chapter 8.
14. Motors greater than or equal to 15HP are recommended to have VFD soft start for energy conservation.
15. Requirements for Conductors: All conductors shall be copper, except "stabiloy" conductors of equivalent capacities may be used in place of copper conductors for sizes No. 4 AWG copper and larger. Use of "stabiloy" conductors in mission critical facilities, dormitories, housing and transient living facilities is further limited to service entrance conductors only, sizes No. 4 AWG copper and larger. Conductors No. 6 AWG and larger shall have heat resistant insulation. Conductors for power and lighting branch circuits shall be No. 12 AWG minimum. Conductors must be properly terminated in accordance with the manufacturers recommended practices.
16. Wiring Methods: Wiring methods and materials shall be according to the National Electric Code (NEC) with the following exceptions and limitations. Exposed wiring in all areas except for industrial areas shall use Surface Metal Raceways and Surface Nonmetallic Raceways as described in Article 352 of the NEC. This applies not only to new construction but also to remodel work.

17. Equipment Grounding Conductors: Types of equipment grounding conductors shall be as specified by the NEC and installed as required by the NEC. Additionally in mission critical facilities, dormitories, housing and transient living facilities all equipment grounding conductors shall be copper only.
18. Restroom fans should be tied to the lights in the restrooms such that the fans don't stay on all the time.
19. Label all panels, transformers, disconnects, etc. with thick plastic engraved labels.
20. All panel boards, motor control centers, and circuits should be final marked according to the as-builts. All receptacles should be tagged according to the as-builts.
21. At BAFB the role of the Energy Management and Control System (EMCS) has been greatly expanded and enhanced. The following items are to be incorporated on all BAFB Mechanical System Projects:
 - EMCS to be Delta Systems Inc. (Sole Sourced) supported by Set Point Systems Corporation, Denver, CO 303 733-2300 BAFB is pursuing switching our EMCS to Johnson Controls Inc. (JCI). This needs to be a consideration for all mechanical projects going forward.
 - EMCS to be connected to the BAFB Native BACKNET System for Network interface.
 - Provide 10% growth capacity on all EMCS Control Panels.
 - BAFB Base EMCS Manager to determine level of EMCS programming capability and capacity for each facility and system specified as pulse meter output with a set of dry contacts included. Install Meter to be easily read.
 - Variable Frequency Drives to be connected to and controlled by EMCS.
 - Building Landscaping Irrigation System to be connected to and controlled by EMCS.
 - Glycol Feeders for Hydronic Systems are to be connected to and controlled by EMCS.
 - Set Point Systems to provide EMCS Training to BAFB Personnel for each installation.
22. Communications Requirements: These Standards are intended to create a standardized concept for planning, designing, installing, constructing, maintaining, and repairing the communications systems on BAFB. In addition to the reference documents, municipal, county, state, and federal codes shall also be followed to provide further guidance. "As-built" records of all improvements shall be provided for incorporation into G.I.S. Communication practices that are important to installation of Communications on Buckley are as follows:
 - Certified and trained communication installers and designers are critical to the success of a certified system upon completion. BICSI standards and certifications are the industry standard for communication installation and is what is required for installation on Buckley.
 - Installing the communications to operate as a system, ensuring all pieces and parts are guaranteed to work together and must be certified by the manufacturers upon completion of installation with trained installers. This is not considered the same as a warranty on each item.
 - Communication closet sizes must be no smaller than 10'x10' in small facilities and 1.1% of the facility size in large critical facilities and information transfer nodes unless written permission is obtained from the 460 SCS for a deviation.
 - Communication closets are dedicated for communications and cannot have water lines anywhere in the area - including behind walls and ceilings, nor can electrical panels or other utility items be collocated in this room.
 - New facilities are required to bring communication lines back to the nearest information transfer node, there is no spare infrastructure in manholes on Buckley for facilities to connect too. Planning for this cost in design is essential to success of the facility.
 - Customer determines the communication required for the facility but some systems are mandatory in every occupied facility such as mass notification, telephone, CATV and LAN. Additional systems may be required such as CCTV, intercom, public address etc. Unmanned or unoccupied facilities still are mandated two (2) 4" ducts and copper connectivity for an emergency telephone.
 - Conduit installations on Buckley must be concrete encased unless otherwise authorized by 460 SCS. Conduit systems will not exceed 500' between pull points and will not exceed a total of 180 degrees in bends between pull points. Pull points are manholes unless handholds are specifically authorized by the 460 SCS.
 - Innerduct authorized for use on Buckley is either multi-celled or blown in innerduct that will allow a minimum of six cells or blown in mesh innerduct per 4" duct. Fiber is mandated to be installed in innerduct; copper must be installed in innerduct when small cable counts would not utilize the full duct properly.
23. Refer to the most recent edition of the Buckley AFB Communications & Cabling Design Standard for additional information.

24. The standard communication manhole is an 8'x8'x8' octagonal manhole with built in ladder. A locking mechanism inside the lid matching the existing system on Buckley. The lid must be cast to say "COMMUNICATIONS" and all materials installed in the manhole will be resistant to corrosion or rust.
25. Buckley Communication Installation Standard is mandatory and will detail industry standards, references, and installation practices that must be adhered too on Buckley AFB.
26. Provide all on-site utility service lines below grade for all Facility Groups (1-4); when mounting elements (such as utility cabinets, communications equipment and water valves) above grade is unavoidable, paint these consistently and provide visual screening following Installation Facilities Standards (IFS).
27. Sanitary Sewer System: The BAFB Infrastructure Plan provides a comprehensive current and future Infrastructure Plan for the Sanitary Sewer systems throughout the Base. The Sewer Water Distribution System (SWS) has many sections of old clay pipe and requires many updates to be in good condition. SWS Improvements are scheduled in the MILCON projects. The City of Aurora provides transportation of BAFB wastewater to the Metro Wastewater Reclamation District. The majority of the collection system drains into a sewer trunk at the NW corner of the Base. The BAFB wastewater collection system is not metered, with the City of Aurora basing sewer fees on winter water consumption. The following items shall be used as a checklist or guide for Sanitary Sewer systems in addition to the publication and documents referenced above:
- Coordinate Sanitary Sewer design and construction with all other site utility systems both horizontally and vertically to avoid conflicts.
 - Provide Sanitary Sewer Plans indicating layout, materials, size, flow velocities, and manhole types and sizes.
 - Provide depth of manholes and pipes.
 - Manhole covers shall be marked "sanitary".
 - Provide construction slopes of all pipes.
 - Provide metallic foil marker tape.
 - Cleanout sweeps shall have sweep fittings not T-fittings.
 - Meters shall be tied to the EMCS. AFI-32-1065 rules.
 - Auto flush devices shall be hard wired and not battery operated.
 - Sanitary Lift Stations shall comply with City of Aurora and Metro Wastewater Reclamation District standards, and applicable BAFB Infrastructure Plans.
 - Provide sewer discharge load requirements for the respective facility in relation to available capacity within the existing system. Provide computer sewer model if necessary.
28. Gas Distribution System: The BAFB Infrastructure Plan provides a comprehensive current and future Infrastructure Plan for the Domestic Gas systems throughout the Base. The Natural Gas provider for the Base is Xcel Energy. The Gas Distribution System (GDS) is almost new and any improvements are regularly scheduled in the Infrastructure MILCON projects. The following items shall be used as a checklist or guide for Gas Distribution systems in addition to the publication and documents referenced above:
- Coordinate Gas Distribution design and construction with all other site utility systems both horizontally and vertically to avoid conflicts.
 - Use polyethylene yellow pipe with thermo-welded connections.
 - Provide metallic foil marker tape.
 - Provide natural gas demand and pressure requirements for the respective facility with respect to available flows and pressures within the existing system. Provide computer model if necessary.
29. Domestic Water System: The BAFB Infrastructure Plan provides a comprehensive current and future Infrastructure Plan for the Domestic Water systems throughout the Base. BAFB obtains potable water from the City of Aurora through a master meter located at the Base perimeter near the intersection of 6th Ave and Aspen Street. The secondary meter delivery point (for emergency use only) is located on the southern exit of the Base at Mississippi Ave. Potable water is used for domestic fire and irrigation at Buckley AFB. Water Distribution System Improvements are regularly scheduled as part of MILCON Infrastructure projects. The following items shall be used as a checklist or guide for Domestic Water systems in addition to the publication and documents referenced above:
- Evaluate existing water pipes from the initial base construction.
 - Coordinate Domestic Water design and construction with all other site utility systems both horizontally and vertically to avoid conflicts.

- Building services shall be a minimum of 6" for domestic and fire requirements.
 - Meters shall be tied to the EMCS. AFI-32-1065 rules.
 - Meter pulse signal output shall be read in gallons.
 - PVC Piping shall be preferred.
 - Laterals and services shall be restrained.
 - Thrust blocks shall be installed at all bends and tees.
 - Provide metallic foil marker tape.
 - Provide cathodic protection.
 - Provide water demand and pressure requirements for the respective facility with respect to available flows and pressures within the existing system. Provide computer water model if necessary.
 - Provide 5¼" Pacer Fire Hydrant (Model WB67-250); equipped with Storz quick connect bayonet fitting and a set of stainless steel butterfly vanes and a "hydra-snap" dust cover. BAFB has started switching to Sigelock Spartan fire hydrants with storz type front.
30. Fire Water System and Hydrants: Required fire hydrants on base shall conform to the following specification:
- Mfg.: Spartan Hydrants by Sigelock Systems (<http://sigelock.com/>)
 - Model: Spartan 300
 - Hydrant Color: Sherwin Williams Industrial Enamel #SW-2193 "Eaglet Beige". In addition, hydrant tops shall be painted per NFPA 291 classification standards. (Refer to NFPA 291, 2013 Edition and UFC 3-600-01 for specific marking colors and requirements)
 - Connector: Hydra-Storz aluminum quick-connect with one-way stainless steel butterfly backflow preventer.
 - Cap: Hydra-Snap ABS plastic protector cap by Hydra-Storz www.hydra-schild.com
 - Spring-mounted aluminum bury-depth rod and flag for snow conditions.
31. Provide the following markings on all fire hydrant tops for classification of flow rate capacities:
- Class AA - Light Blue
 - Class A - Green
 - Class B - Orange
 - Class C - Red
32. Provide installation of utility infrastructure to support near term and future electric vehicle charging stations.
33. Define all service entry points into the building and route distribution below grade into an interior space within the facility; exposed conduits, cables and wires on exterior walls are not permitted for Facility Group 1.
34. Include consideration of appropriate placement of meters in support of Automated Revenue Management Services (ARMS).
35. Limit exterior mechanical distribution systems such as exterior steam, chilled water, and hot water distribution to Group 3 facilities; when required for Group 1 and 2 facilities integrate with the architecture and provide visual screens following IFS.
36. Direct roof drainage to underground collection when feasible or provide splash blocks / paved channels to intercept roof drainage at grade.

C03. PARKING AREAS

Comply with AF Corporate Standards for Site Development:

<http://afcfs.wbdg.org/site-development/index.html>

Comply with AF Corporate Standards for Parking Areas:

<http://afcfs.wbdg.org/site-development/parking-areas/index.html>

C03.1. Configurations and Design

Applicable N/A Select number of graphics / images (large: 800 px x 440 px) to insert 3

Image Tool 800 x 440

Applicable N/A Select number of graphics / images (small: 250 px x 188 px) to insert 3

Image Tool 250 x 188

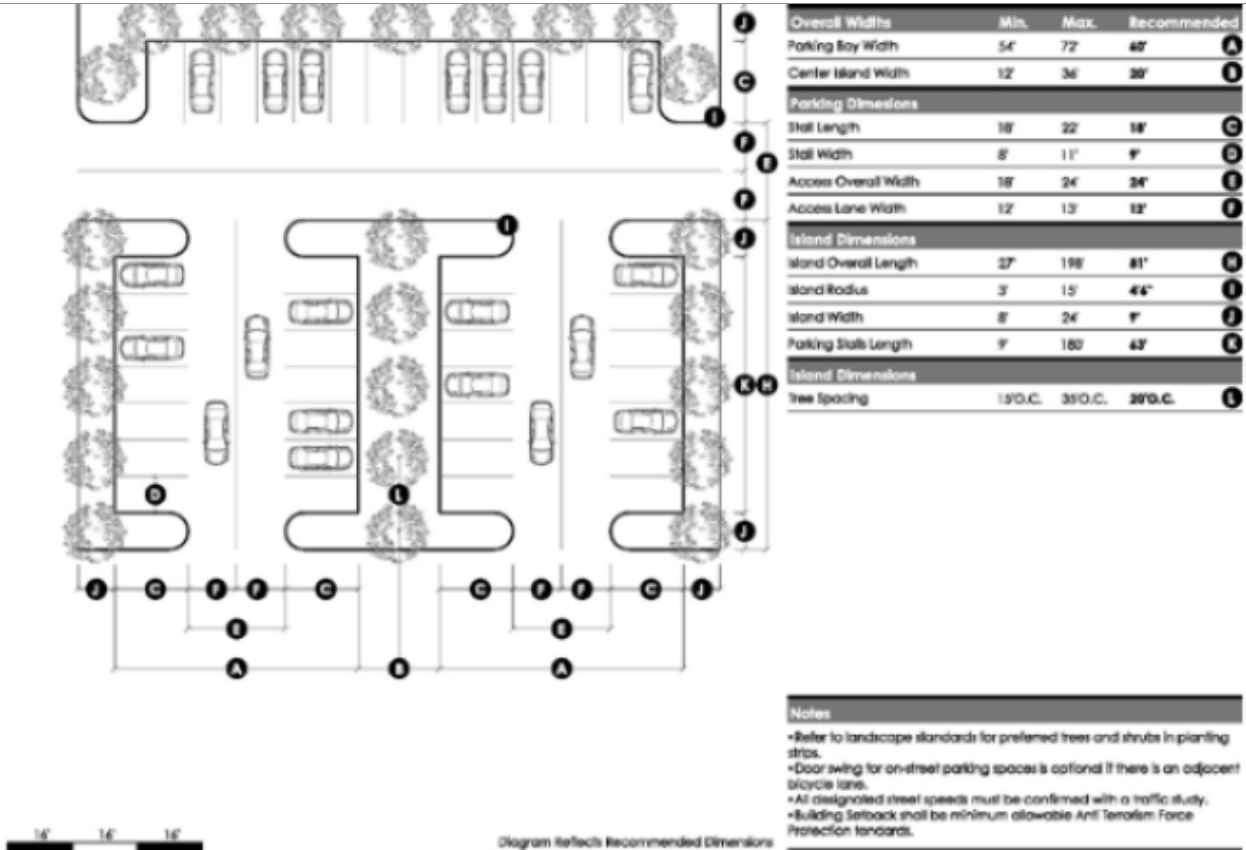
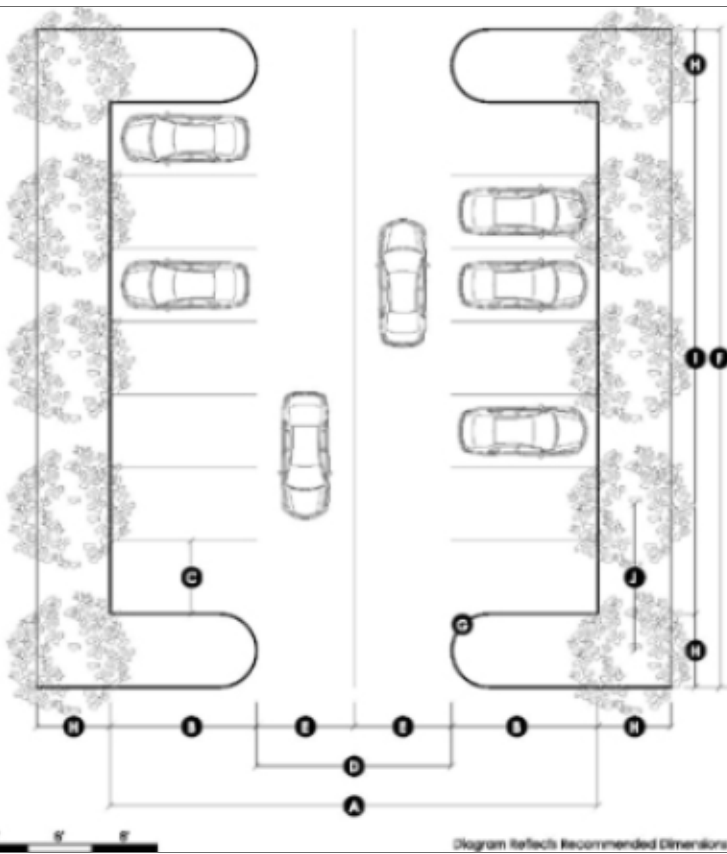

Diagram Reflects Recommended Dimensions

Typical Car Park



Overall Widths	Min.	Max.	Recommended	
Parking Bay Width	54'	72'	40'	A
Parking Stall Dimensions				
Stall Length	18'	22'	18'	B
Stall Width	8'	11'	8'	C
Driving Dimensions				
Access Overall Width	18'	24'	24'	D
Access Lane Width	9'	12'	12'	E
Island Dimensions				
Island Overall Length	37'	198'	81'	F
Island Radius	3'	15'	44'	G
Island Width	8'	24'	8'	H
Parking Stalls Length	9'	180'	43'	I
Island Dimensions				
Tree Spacing	15'O.C.	35'O.C.	18'O.C.	J

Notes

- Refer to landscape standards for preferred trees and shrubs in planting strip.
- Door swing for on-street parking spaces is eorland if there is an adjacent bicycle lane.
- All designated street speeds must be confirmed with a traffic study.
- Building Setback shall be minimum allowable Anti Terrorism Force Protection standards.

Diagram Reflects Recommended Dimensions

Typical Parking Bay

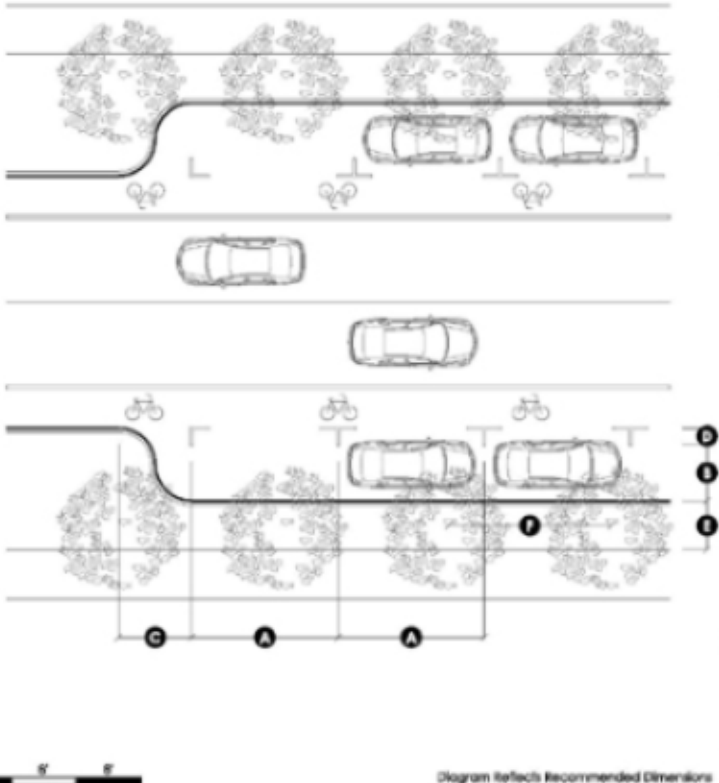

Parking Space Dimensions	Min.	Max.	Recommended	
Space Length	18'	22'	18'	A
Space Width	7'	9'	8'	B
Parking Space Transition	12'	16'	12'	C
Door Swing	2'	3'	2'	D
Planting Strip Dimension				
Planting Strip Width	4'	8'	6'	E
Street Tree Spacing	15'O.C.	35'O.C.	25'O.C.	F

Notes

- Refer to landscape standards for preferred trees and shrubs in planting strip.
- Door swing for on-street parking spaces is eorland if there is an adjacent bicycle lane.
- All designated street speeds must be confirmed with a traffic study.
- Building Setback shall be minimum allowable Anti Terrorism Force Protection standards.

Diagram Reflects Recommended Dimensions

On Street Parking

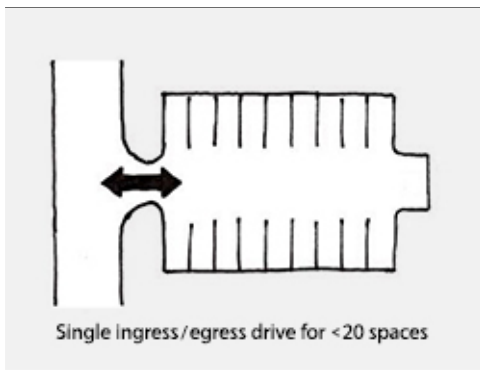

Small Lot Configuration

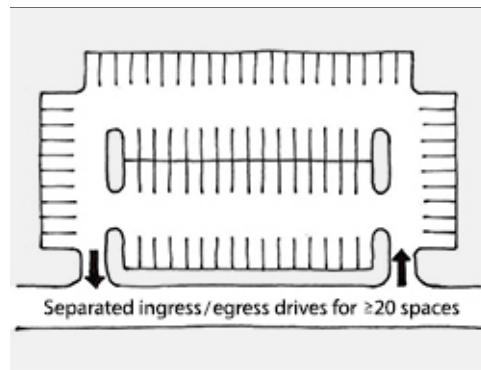

Large Lot Configuration

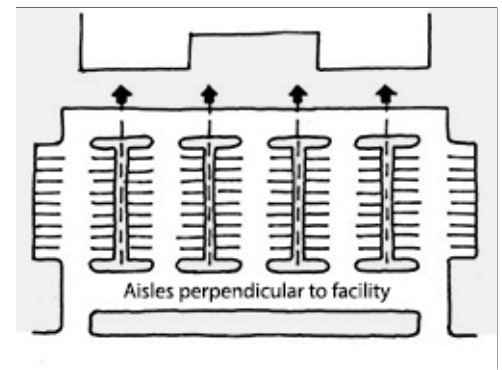

Facility Group 1 Configuration

1. Evaluate adjacent sites and cost-effectively consolidate parking areas to maximize efficient use; ensure that all areas meet accessibility guidelines.
2. Generally envision on-site parking as a series of small connected singular areas selectively placed around the facility served, rather than a single large area; buffer parking areas from the facility main entrance with a transition space and provide drop-offs to decrease close-in parking. Comply with IFS standards while meeting ATFP requirements.
3. Integrate at-grade and raised-profile curbing, permeable paved areas, and parking islands with the stormwater system and direct stormwater to bioswales and rain gardens as source water for regionally appropriate native vegetation.
4. Define pedestrian access with approved hardscape and provide shading along the primary path from the parking area to the main entrance of the building.
5. Coordinate suitable landscape or barriers integrated with walls and fences to ensure adequate force protection.
6. Accessible parking spaces shall be marked according to UFC 3-120-01 and its references in ABAAS and the MUTCD.
7. Consider locations and requirements of near term and future electric vehicle charging stations.
8. Designate preferred parking spaces for electric vehicles and carpools near the main entrance.
9. Consider cost-effectively integrating solar photovoltaic arrays into covered parking structures.
10. Reserved parking is discouraged except for Facility Group 1.
11. On-street parking is discouraged except in multi-use areas. When used, provide approved on-street parking configurations following UFC 3-201-01.
12. Access and service drives should accommodate the largest vehicle serving the facility.
13. Evaluate adjacent sites and cost-effectively consolidate parking areas to maximize efficient use; ensure that all areas meet accessibility guidelines.
14. The preferred arrangement is off-street lots containing no more than seventy-five (75) to one hundred (100) full-car spaces. Facilities requiring more than one hundred (100) spaces shall have a series of lots connected by an external perimeter access drive.
15. Provide the number of spaces required for a facility on the site and meet design requirements for following Air Force Manual 32-1084. Allow sufficient space and potential future expansion.
16. Parking lots must accommodate all vehicles that will serve the facility. Provide access for fire apparatus according to NFPA.
17. Parking lot layouts that promote cross-traffic between parallel streets should be avoided for safety reasons.

18. Generally envision on-site parking as a series of small connected singular areas selectively placed around the facility served, rather than a single large area; buffer parking areas from the facility main entrance with a transition space and provide drop-offs to decrease close-in parking.
19. Locate all parking lots outside required setbacks and preserves. Encroachments must be approved on a case basis and incorporate landscaping, berms, and screen walls as required by Installation Facilities Standards (IFS). Setback requirements from buildings shall be calculated from UFC 4-010-01 Antiterrorism Standoff Distances for Buildings.
20. Appropriately size loading and service dock areas based on operational requirements. Locate these areas to the rear or sides of a building, away from the main building entrance, related high visibility areas, or an incompatible adjacent land use. Clearly separate service areas from adjacent parking lots and access drives with curb and gutter and landscaped "divider strips."
21. Dead-end parking lots shall be avoided and two access drives provided for lots exceeding twenty (20) spaces. If additional access (ingress/egress) drives cannot be provided for larger lots, convenient interior circulation should allow for efficient maneuvering of vehicles.
22. Access drives, which serve parking lots, may be either two-way or one-way.
23. Two-way access drives shall be twenty-six feet (26') wide measured from back of curb to back of curb. One-way access drives shall be fifteen feet (15') wide measured from back of curb to back of curb.
24. Access drives shall be separated from street intersections by a minimum distance of: (a) one hundred feet (100') along arterial streets, (b) seventy-five feet (75') along collector streets, and (c) fifty feet (50') along local streets. To minimize conflicts with street traffic, parking lot ingress and egress access roads should be kept to the minimum necessary.
25. Access and service drives should accommodate the largest vehicle serving the facility.
26. 90-degree spaces and two-way traffic aisles shall typically be used. If required by site limitations or high rate of turnover, 60-degree spaces may be used with one-way traffic aisles. Use consistent and stall sizes throughout a parking area.
27. Parking space dimensions shall be nine feet (9') by eighteen feet (18'-0"); where vehicle overhang is permitted, provide stalls nine feet (9') by sixteen feet six inches (16'-6").
28. Motorcycles can be placed at 4 ½' width, thus two per standard vehicle space. Motorcycle parking must have concrete pavement surfaces to support motorcycle kick stands.
29. Provide parking spaces for disabled use in quantities, sizes and locations as prescribed in the Architectural Barriers Act (ABA).
30. Consider locations and requirements of near term and future electric vehicle charging stations.
31. Designate preferred parking for low-emitting and fuel-efficient vehicles (for 5% of the total vehicle parking capacity on site) and carpools near the main entrance.
32. Consider shading for parking lots following a LCCA. Consider cost-effectively integrating solar photovoltaic arrays into covered parking structures.
33. Reserved parking is discouraged except for Facility Group 1. The Base Security Forces Squadron shall determine the number of reserved parking spaces on an as-needed basis.
34. On-street parking is discouraged except in multi-use areas and family housing areas. When used, provide approved on-street parking configurations following UFC 3-201-01.
35. Drainage water from parking lots should be directed to adjacent landscaped areas to maximize rainfall and snowmelt benefits. In some cases, dry well and small retention ponds may be necessary to accommodate runoff from larger paved areas.

- 36. A principal factor in parking lot grading shall be to provide positive drainage away from buildings and to prevent ponding of water on pavement surfaces.
- 37. Screen open parking lots (except in family housing areas) from view from adjacent buildings with a minimum height of three feet by the use of berms and/or plantings. A minimum of 50% of the affected parking lot perimeter must have the required screen.
- 38. Signage used in conjunction with reserved parking must conform to AFCFS and IFS.

C03.1.1. Paving and Striping

- Applicable N/A Select number of graphics / images (large: 800 px x 440 px) to insert 1
- Applicable N/A Small graphics do not apply

Image Tool 800 x 440



Typical Asphaltic Concrete Paving and White Striping at Group 1

Facility Group 1 paving materials shall be as follows.

- Primary: Permeable pavers or asphaltic concrete
- Secondary: Permeable pavers
- Accent: Concrete edging

Facility Group 2 paving materials shall be as follows.

- Primary: Permeable pavers
- Secondary: Concrete
- Accent: Concrete edging

Facility Group 3 paving materials shall be as follows.

- Primary: Asphalt
- Secondary: Concrete where operationally required
- Accent: N/A

Facility Group 4 paving materials shall be as follows.

- Primary: Asphalt
- Secondary: N/A
- Accent: N/A

1. All new parking lots in Groups 1 and 2 shall be constructed of permeable brick pavers. Paver stall areas shall be separated from the asphalt drive aisles with a 6" wide by 12" deep at grade concrete edge barrier.
2. Porous asphalt is not an acceptable product for the local climate at Buckley AFB; porous concrete may be considered on a case basis.
3. Cost-effectively provide light-colored concrete to reduce heat island effect; otherwise install asphaltic concrete paving. Dirt, gravel, and grass lots are not allowed.
4. Use consistent striping, angles and stall sizes in all parking areas.
5. All parking shall be marked with white stripes of paint or applied vinyl coatings. Red or yellow markings shall only be used for safety purposes and must be kept to a minimum. All lines shall be four inches (4") wide.
6. Disabled spaces shall be marked with signs following section C08.1.8.

C03.1.2. Curbing

Applicable N/A Large graphics do not apply

Applicable N/A Select number of graphics / images (small: 250 px x 188 px) to insert 3

Image Tool 250 x 188

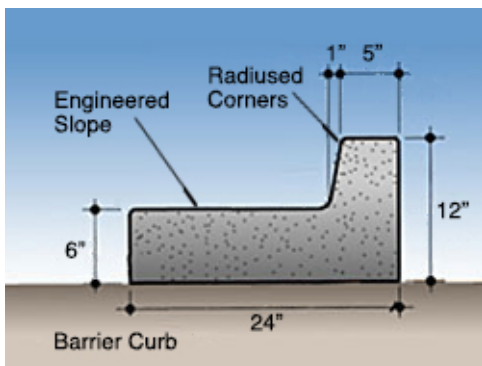

"Barrier" Curb

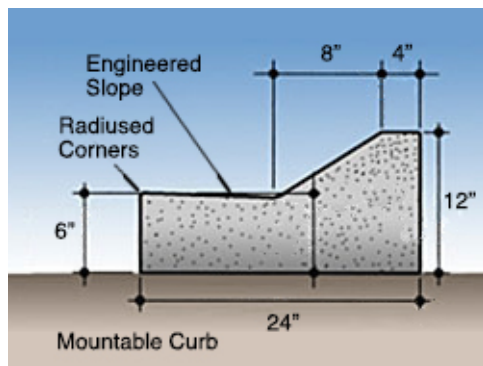

"Mountable" Curb

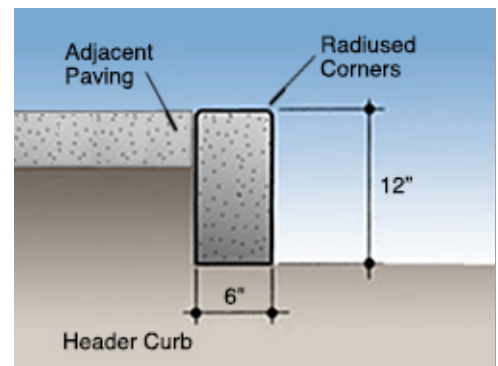

Header Curb

Facility Group 1 curbing / edging materials shall be as follows.

Primary: Concrete

Secondary: N/A

Accent: N/A

Facility Group 2 curbing / edging materials shall be as follows.

Primary: Concrete

Secondary: N/A

Accent: N/A

Facility Group 3 curbing / edging materials shall be as follows.

Primary: Concrete

Secondary: N/A

Accent: N/A

Facility Group 4 curbing / edging materials shall be as follows.

Primary: Concrete

Secondary: N/A

Accent: N/A

1. Define all parking lots with either raised profile or at-grade curbing to promote drainage and protect paving edges. All raised curbs shall be the rolled (mountable) type.
2. Integrate curbing to direct stormwater to bioswales and rain gardens as source water for regionally appropriate native vegetation.
3. Wheel stops are not permitted except at locations where car bumpers could contact adjacent items such as poles, signs or pedestrians.

C03.1.3. Internal Islands and Medians

Applicable N/A Large graphics do not apply

Applicable N/A Small graphics do not apply

1. Install landscape islands and medians as visual breaks, to reduce heat island effects and to accommodate bioswales and rain gardens with consideration for snow removal. Coordinate suitable landscape or barriers integrated with walls and fences to ensure adequate force protection.
2. When lighting is necessary, contain fixture bases within medians or internal landscape islands.

C03.2. Parking Structures

Applicable N/A Large graphics do not apply

Applicable N/A Small graphics do not apply

1. Parking structures are encouraged in land-constrained locations when economically feasible.
2. Consider near term and future electric vehicle charging stations and renewable energy generation development during the analysis and design.
3. Consider opportunities for integrating parking structures into multi-use developments with pedestrian-oriented uses located on the ground floor and parking on upper levels; ensure AFTP guidelines are fully addressed.
4. Structures may be constructed below grade with roofs serving as vegetated areas or plazas.

C03.3. Connectivity

Applicable N/A Large graphics do not apply

Applicable N/A Small graphics do not apply

1. Refer to the Installation Development Plan (IDP) for locations of transit stops and pedestrian and cycling networks; provide appropriately sized sidewalks and bike paths to connect facilities and users to these networks.
2. Provide amenities such as rain and shade shelters, trees, and benches to encourage and facilitate use of public transportation.
3. Evaluate the IDP for the current and planned network of roads and optimally develop vehicular access to and from the site.
4. Define pedestrian access with approved hardscape, provide shading, and provide safe, efficient travel from vehicles along the primary path from the parking area to the main entrance of the building. Emphasize building main entrances in the alignment of landscape median/pedestrian paths.

C04. STORMWATER MANAGEMENT

Comply with AF Corporate Standards for Site Development:

<http://afcs.wbdg.org/site-development/index.html>

Comply with AF Corporate Standards for Stormwater Management:

<http://afcs.wbdg.org/site-development/stormwater-management/index.html>

C04.1. Stormwater Requirements

Applicable N/A Large graphics do not apply

Applicable N/A Select number of graphics / images (small: 250 px x 188 px) to insert 3

Image Tool 250 x 188



Street with Integrated Stormwater System



Stormwater Feature at Trail



Rock Mulch at Drainage Swale

1. Stormwater Management: The 460 SW is responsible for all aspects of stormwater management on Buckley AFB, as the permittee and operator of a Municipal Separate Storm Sewer System (MS4) issued by the US Environmental Protection Agency. This responsibility includes construction and industrial activities conducted by either the Air Force or tenant organizations. The following items shall be used as a checklist or guide for systems in addition to the Environmental Site Requirements and documents referenced above:
 - Provide Storm Sewer Plans that address layout, materials, water quality, infiltration, and detention. Materials shall include, but not be limited to: Reinforced Concrete Pipe, Flared-End Sections, Riprap or buried geotextile fabric.
 - Water Quality measures shall include products such as silt fencing, sediment logs, and more.
 - Stormwater runoff volumes and velocities at new development sites shall be as close as practical to pre-development values.

- Best Management Practices (BMPs) to control erosion and sediment during construction and post-construction phases shall be utilized. Refer to the City of Aurora Drainage Criteria Manual, Urban Drainage and Flood Control District (UDFCD) volumes, and Unified Facilities Criteria (UFC) 3-210-10, Design: Low-Impact Development Manual.
- Regional detention ponds are preferred as opposed to site-specific detention ponds.
- Provide maintenance procedures/plans for drainage and water quality measures (i.e. swales, detention ponds, etc.)
- Coordinate storm sewer and storm water management design and construction with all other site utility systems both horizontally and vertically to avoid conflicts.
- Provide State SWMP/NPDES

2. Coordinate with landscaping plans; specifically the seed mixes for swale, overflow, and detention areas.

3. Design all stormwater systems including, detention areas, channels, etc. as on-site amenities that are consistent with natural systems and drainage patterns, that help sustain the base landscape with beneficial functionality and that provide aesthetic appeal; coordinate with the base Stormwater Management Plan.

4. Incorporate bioswales into the design of all roadway, parking and facility roof systems to enhance water quality and support the overall stormwater system.

5. Permeable paving may be used in areas that are not subjected to severe freeze-thaw cycles.

6. Provide rainwater harvesting and storage that is attached to the building's roof drain systems to support grey water irrigation; consider freeze protection for winter months.

7. When underground drainage systems are required establish a maintenance program to include removal of sediments and debris; inspect joints seasonally for alignment to prevent leakage and the development of voids and surface failures.

8. Cost-effectively integrate stormwater systems with ATRP measures.

1. Stormwater Management: The 460 SW is responsible for all aspects of stormwater management on Buckley AFB, as the permittee and operator of a Municipal Separate Storm Sewer System (MS4) issued by the US Environmental Protection Agency. This responsibility includes construction and industrial activities conducted by either the Air Force or tenant organizations. The following items shall be used as a checklist or guide for systems in addition to the Environmental Site Requirements and documents referenced above:

- Provide Storm Sewer Plans that address layout, materials, water quality, infiltration, and detention. Materials shall include, but not be limited to: Reinforced Concrete Pipe, Flared-End Sections, Riprap or buried geotextile fabric.
- Water Quality measures shall include products such as silt fencing, sediment logs, and more.
- Stormwater runoff volumes and velocities at new development sites shall be as close as practical to pre-development values.
- Best Management Practices (BMPs) to control erosion and sediment during construction and post-construction phases shall be utilized. Refer to the City of Aurora Drainage Criteria Manual, Urban Drainage and Flood Control District (UDFCD) volumes, and Unified Facilities Criteria (UFC) 3-210-10, Design: Low-Impact Development Manual.
- Regional detention ponds are preferred as opposed to site-specific detention ponds.
- Provide maintenance procedures/plans for drainage and water quality measures (i.e. swales, detention ponds, etc.)
- Coordinate storm sewer and storm water management design and construction with all other site utility systems both horizontally and vertically to avoid conflicts.
- Provide State SWMP/NPDES

2. Coordinate with landscaping plans; specifically the seed mixes for swale, overflow, and detention areas.

3. Design all stormwater systems including, detention areas, channels, etc. as on-site amenities that are consistent with natural systems and drainage patterns, that help sustain the base landscape with beneficial functionality and that provide aesthetic appeal; coordinate with the base Stormwater Management Plan.

4. Incorporate bioswales into the design of all roadway, parking and facility roof systems to enhance water quality and support the overall stormwater system.

5. Permeable paving may be used in areas that are not subjected to severe freeze-thaw cycles.

6. Provide rainwater harvesting and storage that is attached to the building's roof drain systems to support grey water irrigation; consider freeze protection for winter months.

- 7. When underground drainage systems are required establish a maintenance program to include removal of sediments and debris; inspect joints seasonally for alignment to prevent leakage and the development of voids and surface failures.
- 8. Cost-effectively integrate stormwater systems with ATRP measures.

C05. SIDEWALKS, BIKEWAYS AND TRAILS

Comply with AF Corporate Standards for Site Development:

<http://afcs.wbdg.org/site-development/index.html>

Comply with AF Corporate Standards for Sidewalks, Bikeways and Trails:

<http://afcs.wbdg.org/site-development/sidewalks-bikeways-trails/index.html>

C05.1. Circulation and Paving

Applicable N/A Select number of graphics / images (large: 800 px x 440 px) to insert 1

Image Tool 800 x 440

Applicable N/A Select number of graphics / images (small: 250 px x 188 px) to insert 3

Image Tool 250 x 188



Concrete Sidewalk with Complimentary Landscaping



Alignment with Main Entrance



Link to Parking Area



Connection to Trail Network

Facility Group 1 sidewalks, plazas, and courtyards paving materials shall be as follows.

Primary: Pervious Pavers

Secondary: Concrete Edging

Accent: N/A

Facility Group 2 sidewalks, plazas, and courtyards paving materials shall be as follows.

Primary: Pervious Pavers

Secondary: Concrete Edging

Accent: N/A

Facility Group 3 sidewalks, plazas, and courtyards paving materials shall be as follows.

Primary: Permeable concrete

Secondary: N/A

Accent: N/A

Facility Group 4 sidewalks, plazas, and courtyards paving materials shall be as follows.

Primary: Permeable concrete

Secondary: N/A

Accent: N/A

1. Maintain efficient geometry and accessibility to connect building entrances to adjacent parking areas and activity areas and to the base transportation system following ATRP. Efficiently use materials to optimize life-cycle costs and to minimize maintenance.
2. Generally conform horizontal layouts of sidewalks to the geometric configuration of adjacent buildings, streets, parking lots, and other adjacent related site amenities. Occasional meanders and/or jogs may be included to capture views, to coordinate with landscaping or accommodate site constraints.
3. Walks in parking areas shall provide a direct path using "safe islands" and "peninsulas" to encourage safety. Walks parallel to streets shall follow streetscape guidelines. Clearly mark pedestrian crossings at vehicular routes.
4. Mitigate heat island by providing high-albedo, shaded sidewalks. Pervious pavers shall be used on all sidewalks, plazas and courtyards in Facility Groups 1 and 2; use pervious concrete in Groups 3 and 4. The designer shall incorporate appropriate expansion and construction joints.
5. Only experienced contractors will install pervious pavements.
6. Consider an integrated approach that could include stormwater management (permeable surfaces) and complement the design of the storm drainage system when appropriate.
7. Pedestrian paths should be at least 5' in width to allow for comfortable side-by-side walking.
8. Sidewalks leading to a building main entrance and at the interior of parking lots shall be a minimum width of 6'. Walks greater than 10' wide may be used at high-density pedestrian areas where volumes of traffic justify added material.

9. Where cars park adjacent and head-in to the sidewalk and wheel stops are not used, such perimeter walks shall be increased to a minimum width of 8' to accommodate overhangs of the parked vehicles.
10. All sidewalks shall have positive drainage to prevent ponding of water or ice accumulation with slopes ranging from 2.1% to 4.2%. Walks with a slope greater than 4.2% shall be designed as ramps following accessibility guidelines. All walks shall have a minimum cross slope of 2.1%.
11. Pavers shall conform to the following range of color: beiges, tans, browns, or terra cotta. Pavers used on walks shall typically be 4" x 8" in size.
12. Group 1 and 2 Entry area sidewalks to have snow melt systems.
13. Connect to the bicycle circulation system and provide bicycle parking with a suitable means for securing bicycles following IFS. Consider changing/shower facilities for use by cyclists.
14. Refer to the Installation Development Plan for future trails, bicycle paths, and sidewalks.

C05.1.1. Ramps and Stairs

Applicable N/A Large graphics do not apply

Applicable N/A Small graphics do not apply

1. Use ramps instead of stairs for sidewalks, bikeways and trails and at all buildings where possible. Where steps are unavoidable, follow UFC 1-200-01 and its references to the international Building Code.
2. Use ramps instead of steps for sidewalks, bikeways and trails and at all buildings. Where steps are unavoidable, the following shall apply:
 - a. Materials shall be limited to combinations of concrete and brick conforming to this IFS.
 - b. Minimum riser height shall be 4" and a maximum of 7", and the minimum tread depth shall be 11".
 - c. Open treads or recesses at nosings that may catch shoe toes shall not be used.
 - d. Provide handrails at steps containing two (2) or more risers. Do not use a central rail unless steps are more than 88" wide.
3. The minimum clear width of steps shall be five feet.

C05.1.2. Lighting

Applicable N/A Large graphics do not apply

Applicable N/A Small graphics do not apply

1. Provide lighting for all stairs and landings where traffic warrants.
2. Refer to the Lighting section for path lighting along sidewalks, bikeways and trails.

C06. LANDSCAPE

Comply with AF Corporate Standards for Site Development:
<http://afcs.wbdg.org/site-development/index.html>

Comply with AF Corporate Standards for Landscape:
<http://afcs.wbdg.org/site-development/landscape/index.html>

C06.1. Climate-based Materials

Applicable N/A Large graphics do not apply

Applicable N/A Select number of graphics / images (small: 250 px x 188 px) to insert 3

Image Tool 250 x 188



Native Species



Xeric Planting with Rock Mulch



Drought Tolerant Planting

1. Use only native, naturally occurring, drought tolerant indigenous plant species (including grasses) appropriate for the locale to promote energy efficiency and water conservation, preserve drainage patterns, inhibit erosion, improve air quality, lower maintenance, and add beauty.
2. Follow details and specifications for climate appropriate materials through the Colorado State University Extension program, as well as, the American Nursery and Landscape Association.

C06.1.1. Landscape Design Concept

Applicable N/A Large graphics do not apply

Applicable N/A Select number of graphics / images (small: 250 px x 188 px) to insert 3

Image Tool 250 x 188



Trees and Native Grasses



Trees and Groundcover at Sidewalk



Trees and Shrubs near Building Entrance

1. The overall objective of the use of plant material within the installation is to improve the physical and psychological well-being of the people who live and work on the installation. This is achieved through the preservation and enhancement of mature trees, forest lands, and detailed planting features such as shrubs and groundcovers, as well as, improve the overall visual quality of the installation through the use of native plant material to:
 - a. Blend the built and natural environment
 - b. Provide scale and comfort to pedestrian environment
 - c. Reinforce the hierarchy of the circulation system
 - d. Screen unsightly views or elements
 - e. Buffer incompatible land uses

- f. Minimize maintenance through the use of native plant materials that require less maintenance to survive
2. Preserve and enhance mature trees, forest lands, and detailed planting features such as shrubs and groundcovers.
3. Improve the overall visual quality of the installation through the use of native plant material to:
 - a. Blend the built and natural environment
 - b. Provide scale and comfort to pedestrian environment
 - c. Reinforce the hierarchy of the circulation system
 - d. Screen unsightly views or elements
 - e. Buffer incompatible land uses
 - f. Minimize maintenance through the use of native plant materials that require less maintenance to survive
4. The design guidelines for proposed plantings must be reviewed to ensure that site conditions (soil, topography, adjacent uses, and architecture) and climatic criteria (sun, shade, and moisture requirements) are considered in the desired plant design and selection (i.e. form, texture, color, size). The uses and users of the site must also be considered. Landscape planting plans will be approved by qualified personnel to provide quality assurance and promote design consistency.
5. Develop, maintain and implement a climate-based plant list with landscape features using a regionally appropriate palette of materials to promote energy efficiency, preserve drainage patterns, inhibit erosion, improve air quality, lower maintenance and add beauty. Follow UFC 3-201-02 Landscape Architecture.
6. Landscaping is required for all newly developed sites and facilities; preserve existing native landscape where possible and avoid overplanting.
7. Concentrate landscaping in Facility Groups 1, 2, and along major thoroughfares and integrate these landscaped areas into the base's stormwater management plan. Refer to the Streetscape Envelope Standards in this IFS.
8. All Facility Group 1 and 4 sites shall be landscaped at their entire perimeter; limit formal planting arrangements to formal spaces typically associated with Group 1. Landscape public spaces near the main entrances of Group 1 and 2 facilities.
9. Facility Group 3 sites may have a native undisturbed landscape.
10. Facility plantings shall follow the Installation Facilities Standards (IFS) plant list, which is based on the specific microclimates created by the adjacent building: shadow areas, protected areas, zones adjacent to thermal mass, and availability of rainwater and/or grey water.
11. Provide open spaces as transitions between developed and native areas that promote quality of life and provide visual relief and allow walkable connections to the transportation system.
12. Return suitable areas to a natural state to minimize and, whenever possible, eliminate ground maintenance requirements; expand prairie areas where appropriate with native plants to eliminate mowing and maintenance requirements.
13. In tree clusters replace grass with naturalized shrub beds and leaf litter mulch to eliminate mowing requirements.
14. Use plantings in open spaces to reinforce the space as a visual asset.
15. Consider landscape windbreaks when suitable for the local climate.
16. Integrate security requirements into the landscape design. Coordinate the heights of trees and shrubs and note restrictions for plantings following UFC 4-010-01.
17. Berms and ditches may be used as an integral part of the overall landscape strategy for screening, security and/or visual interest.

C06.1.2. Xeriscape Design Principles

Applicable N/A Large graphics do not apply

Applicable N/A Select number of graphics / images (small: 250 px x 188 px) to insert 3

Image Tool 250 x 188



Native Grasses



Rock Mulch



Pervious Paving Adjacent to Plantings

1. Apply xeriscape principles following UFC 3-201-02, Appendix B, and Air Force Corporate Facilities Standards.
2. Minimize Turf- Throughout the site design process, it is important to limit areas of high water use turf to areas of intensive use by people. Such areas include active recreation areas and areas highly visible by pedestrians (i.e. building main entrances). Turf grasses should be used as a ground plane amenity and not just as infill material. High water use turf should not be used on slopes greater than 4:1, or in medians and narrow strips of planting that are less than 12' wide, whether in a parking lot application, roadway median or setback area.
3. Planning and Design- As each new facility is planned, it is important to consider the traditional aspects of site design, topography, slope orientation, user needs, program elements, soils, vehicular and pedestrian circulation, access, and existing vegetation. The integration of Xeriscape principles with traditional site planning enables the designer to introduce water conservation methods throughout the design process. Special attention should be placed upon the microclimates created by the building and subsequent plant grouping and locations.
4. Irrigation systems should be zoned so those plant materials with similar water demands are on the same irrigation zone (i.e. high water use turf separated from shrubs and ornamental grasses). Professionally designed and drawn irrigation plans should be an integral part of each new building or landscape plan. The plans should specifically address application methods, natural precipitation, and application rates for the individual zones. Plans also need to indicate tap locations, controller type, type and size of heads, drip methods, type and size of mainline, laterals, water pressure, and meter locations. Hand irrigation by water truck is permitted at Buckley AFB only to establish self-sustaining prairie grasses and Buffalo grass for one year, and only in areas that do not have access to an existing water line.
5. Plant Material- Plant selection and location are critical components of the xeriscape principles. Plants should be placed together in groupings of plants that require similar amounts of water. Within the plant palette there are plants that are more appropriate for more formal applications than others. The low water use plants tend to have a more informal appearance and arrangement than higher water use plants. An additional issue with regard to plant selection is the stand-off distances from buildings and other related force protection requirements. The force protection guidelines need to be followed. The plant material should be placed in masses rather than sporadically placed for maximum visual impact. In addition, maintenance is easier and quicker around one massed shrub bed, rather than around many plants scattered in turf areas.
6. Mulches- Organic mulches act to cool the soil during hot weather, thereby reducing the evaporation and subsequent water use. Mulches also reduce the growth of weeds and buffer soil temperature fluctuations throughout the year. Inorganic mulches are very beneficial and have excellent applications for specific purposes. When rock mulches are used, it is beneficial to use a variety of sizes and integrate larger boulders into the design palette to provide greater visual interest. Grouping the larger rocks together to create, for example, dry streambeds, is an effective technique. Large expanses of rock mulch by themselves are not good examples of xeriscape principles, because they create hot, hostile, and uninviting spaces. Volcanic rock will not be allowed to be used as a bed mulch. The trees and shrubs should be

placed in mulched areas rather than in turf areas so that irrigation can be zoned separately. This arrangement also facilitates easier maintenance activities. An alternative to the vast expanses of rock mulch includes dry-land grass areas that receive periodic watering and mowing. Transitions from the intensive landscape to these remote areas can be created by shrub and tree masses and mowing patterns.

7. **Soil Evaluation and Improvements** - The soils on Buckley Air Force Base are typically clay with fine sand or sand with silt or clay. Some soils are susceptible to collapse, and expansive soils are occasionally encountered. Although you cannot turn clay soils into ideal planting soils, you can improve them by a variety of methods that will cause the soil particles to form small granules and crumbs. The best treatment for this purpose is to incorporate large amounts of organic matter into the soil to improve soil structure. The improved condition may remain even long after the organic matter has disappeared. Aged one-year-old dairy manures, green plant material, compost and leaf mold are especially good for improving soil condition. Materials that decay very slowly, such as peat moss, straw, sawdust, rice hulls and shredded bark are somewhat less desirable because they do not aggregate the soil as well. These organic materials, when first incorporated into the soil, will compete with plants for the available nitrogen, an important plant nutrient. Apply extra nitrogen to the soil when using these materials, especially if you intend to plant immediately after adding the organic matter. The slowly decaying materials, such as sawdust and bark, do not necessarily improve soil structure immediately. They serve mainly as fillers to increase the percentage of large pores and to improve soil permeability, or drainage. Large quantities of these materials are generally required to have value as fillers; as much as one-half, by volume of soil, could be needed for the treatment. Gypsum is often recommended to improve clay soils. However, this amendment is primarily useful for improving sodic (alkali) soils, which often have poor structure. Gypsum will not improve a clay soil unless the soil also happens to be sodic.
8. **Maintenance Practices**- Sound maintenance practices include regular watering, fertilizer applications, pesticide management, and sound horticultural principles. With the integration of xeriscape principles it will become more important to ensure that properly scheduled maintenance practices occur. The mowing height and mowing schedule will impact the growth, health, and appearance of the different types of grasses. For optimal root growth and drought resistance, turf grasses should be mowed at a 2 1/2" - 3" minimum. Native grass areas do not need to be mowed and in actual fact, perform and establish better if left in an unmowed condition. Mowing at a turf height exposes the crown of sensitive native grasses to direct sunlight, resulting in sunscald. If a more manicured look is necessary, management practices should be adjusted to include a 6" to 8" mowing height. Sunscald is minimized and still allows the reestablishment of the prairie. Mowing every 6 to 8 weeks during the establishment period, however, can facilitate weed control. Establishment watering is also recommended. Regular aeration and mulching of clippings reduces soil compaction, improves aeration, controls excess thatch, increases water infiltration, encourages root growth and further improves drought resistance of turf areas. Soil improvements, annual applications of organic matter and using organic mulches in the shrub beds will increase the water-holding capacity of the soil in those areas. Initially, as areas are renovated and retrofitted from turf areas to shrub areas, maintenance personnel will need to become familiar with the different maintenance requirements for the new areas. This initially may result in higher maintenance costs. The time to mow, aerate, and fertilize turf areas is greater than the time required to weed, replace mulch, fertilize and clean up shrub areas.
9. Facility plantings are encouraged to use native plant species and to consider specific microclimates created by the adjacent building: shadow areas, protected areas, zones adjacent to thermal mass, and availability of rainwater and/or grey water.

C06.1.3. Minimizing Water Requirements

Applicable N/A Large graphics do not apply

Applicable N/A Select number of graphics / images (small: 250 px x 188 px) to insert 3

Image Tool 250 x 188



Organic Mulch Installation



Use of Xeric Plant Species



Use of Pervious Surfaces

1. Reasonably reduce demand on potable water while seeking opportunities to increase alternative water sources for irrigation. Reduce or eliminate the use of potable/domestic water for purposes of landscape architecture maintenance, consistent with existing legal or contractual obligations, and prohibit potable-water irrigation in new construction beyond establishment following current DoD and Air Force policy.(Link TBD)
 - a. Prohibit potable water use to irrigate new landscaping other than for plant establishment;
 - b. Apply drought resistant, water smart, and/or xeriscaping landscape architectural design to all new and updated landscape architecture;
 - c. Prohibit ornamental or potable water features in new landscape design;
 - d. Phase out ornamental or potable water features in older landscape designs. Water features listed on the National Register of Historic Places are exempt;
 - e. Assess irrigated turf grass areas and install non-water intensive native vegetation where reasonable;
 - f. Assess existing landscape irrigation systems for leaks and system inefficiencies, and consider replacing, upgrading, or converting to an alternative water source when reasonable;
 - g. Make water conservation for golf courses a priority, and use alternative water in lieu of potable water if sources are available.
2. Best Management Practices for Self-Sustaining Grasses: The primary goals of landscaping at Buckley AFB are: improve erosion control and protection of watersheds from excess sediment, prevent soil loss due to storm water runoff and wind erosion, achieve maximum water conservation by establishing Self-Sustaining non-irrigated turf grasses wherever possible, prevent the intrusion of noxious weeds and pests through careful selection of plant materials, improve the aesthetics and visual appeal of streetscapes and facilities with creative and responsible landscape design.
3. The single most effective and most visible improvement to achieve all of these goals will be an aggressive effort to re-vegetate and restore all disturbed and eroded areas within the developed area of the Base with Self-Sustaining non-irrigated prairie grasses. The Best Management Practices specified in this Section are mandatory practices enforced by Federal, State, and Local regulations.
4. Landscape designers and planners must incorporate Self-Sustaining non-irrigated prairie seed grasses selected from the Approved Plant List for large area turf and lawn projects. These grass mixes were designed to yield tremendous long-range benefits with a short life-cycle payback. All of the best planning and landscape design is futile if these Best Management Practices are not strictly followed.

C06.1.4. Plant Material Selection

Applicable N/A Select number of graphics / images (large: 800 px x 440 px) to insert 1

Image Tool 800 x 440

Applicable N/A Select number of graphics / images (small: 250 px x 188 px) to insert 3

Image Tool 250 x 188



Native Trees, Grasses, Groundcover and the Use of Organic and Rock Mulch



Drought Tolerant Grasses



Grasses with Seasonal Color



Limited Ornamental Annual Planting

1. New facilities are encouraged to use native plant species as indicated on the following plant lists published by Colorado State University Extension for the Plains Region:
 - a. Native Shrubs: <http://extension.colostate.edu/topic-areas/yard-garden/native-shrubs-for-colorado-landscapes-7-422/>
 - b. Native Trees: <http://extension.colostate.edu/topic-areas/yard-garden/native-trees-for-colorado-landscapes-7-421/>
 - c. Native Herbaceous Perennials: <http://extension.colostate.edu/topic-areas/yard-garden/native-herbaceous-perennials-for-colorado-landscapes-7-242/>

- d. Refer also to Peterson AFB's Facilities Excellence Plan plant lists: http://fennelgroup.com/clients/AFDFS2016/pdf_files/Peterson%20AFB%20Plant%20List.pdf
2. Trees should be the focus of landscape plantings and, where possible, should be a mix of deciduous and evergreen species for variety; provide tree grates when appropriate and use tree guards on smaller trees.
3. Ground covers are only recommended when minimal maintenance is required.
4. Turf areas should be limited to those that can be sustained by natural rainfall or grey water (non-potable) irrigation systems; turf may be defined by at-grade concrete mow strips to lessen maintenance.
5. Analyze soils and provide organic amendments to as needed to improve plant growth and conserve water. The general rule is to add 3-4 cubic yards of organic matter per 1,000 square feet of area in addition to appropriate 2-4 inches of topsoil. The amendments should be well integrated into the soil at least 6-8 inches to encourage deep root growth.
6. Use only native, naturally occurring plant materials including grasses or turf suited for the local climatic conditions in the landscape design; potable-water irrigation systems are discouraged beyond the establishment period.
7. Best Management Practices for self-sustaining grasses is a primary goal of landscaping at Buckley AFB. Strategies to meet this goal include improving erosion control and protection of watersheds from excess sediment, preventing soil loss due to storm water runoff and wind erosion, achieving maximum water conservation by establishing Self-Sustaining non-irrigated turf grasses wherever possible, preventing the intrusion of noxious weeds and pests through careful selection of plant materials, and improving the aesthetics and visual appeal of streetscapes and facilities with creative and responsible landscape design.
8. The single most effective and most visible improvement to achieve all of these goals will be an aggressive effort to re-vegetate and restore all disturbed and eroded areas within the developed area of the Base with self-sustaining non-irrigated prairie grasses. The Best Management Practices specified in this Section are mandatory practices enforced by Federal, State, and Local regulations.
9. Compost: Existing topsoil shall be removed during excavation for new construction and stockpiled at the direction of the Project Manager. The Project Manager shall evaluate the topsoil to determine if it is suitable for reapplication after seeding. A soil analysis shall be performed to identify any additional soil amendments that may be required. Organic soil amendments (compost) shall be uniformly applied over the entire landscaped area at a minimum depth of 2 inches and incorporated to a depth of 8 inches (for a 20% to 30% inclusion rate) using a rotary tiller. Compost shall meet or exceed US EPA Class A standard, 40 CFR Section 503. Certificates of Compliance for Compost shall be submitted indicating grade and compliance with state and local regulations. Pre-planting fertilizer and pH adjusting agents (e.g., lime and sulfur) may be applied before incorporation as necessary. Rake the soil surface smooth prior to seeding. The soil surface shall be free of large clods, roots, stones greater than 2-inches, and other material which might interfere with planting and subsequent site maintenance. Water thoroughly after seeding. Top dress newly seeded turf areas with ¼-inch layer of fine compost (3/8-inch screen, minus), then water to protect against hot, dry weather or drying winds. Where an irrigation system is unavailable, water shall be provided by the Contractor and hand applied by truck. The Contractor may request permission from the Base to fill water trucks from a Base fire hydrant or from the off-Base reclaimed water station. In either case water usage will be metered and billed to the Contractor.
10. Seeding: Seed mix shall be specified by the Project Manager from the Buckley Approved Plant List published in the IFS (Short-grass Prairie Mix; Overflow Seed Mix; Tall-grass Prairie Mix; or Wetland Seed Mix).
11. All seeding shall be accomplished using a drill seeded using a mechanical power drawn drill followed by packer wheels or drag chain. Use a drill seeder capable of handling native seed. Mechanical power-drawn drills shall have depth bands set to maintain a planting depth of at least 0.5-inches into the soil and shall be set to space the rows not more than seven (7) inches apart. Seed that is extremely small shall be sowed from a separate hopper adjusted to the proper rate of application. On slopes greater than 4:1 the contractor shall broadcast seed on freshly disturbed (raked or harrowed) soil surfaces. Following broadcast seeding the contractor shall immediately rake or harrow the seeds into the surface. Raking shall be accomplished using metal-tined garden or landscape rakes. If harrowing is used, an English harrow or its equivalent shall be used. Seed must be uniformly distributed in the broadcasting device, and seed must be evenly distributed throughout the limits of the project. Cover the applied seed with a soil thickness no greater than 0.5 inches deep. Add a 'Nurse Crop' seed such as oats or rye to all seed mixes. These germinate quickly, reduce soil erosion, provide quick green cover, save soil moisture, and discourage weed growth by shading the soil surface until the grass seed has proper conditions to germinate and provide cover.

12. Hydro Seeding / Hydro Mulching Prohibited: Hydraulic seeding or hydraulic mulching is not permitted. The practice of applying grass seed to the surface of the soil along with a slurry of water and cellulose mulch has proven to have a poor performance record at Buckley AFB.
13. Planting Season: Seeding shall be restricted according to the following timetable and specifications:
 - a. Spring seeding is allowed from Spring thaw to May 15th, where "spring thaw" is defined as the earliest date in which seed can be buried 0.5-inches into the surface topsoil through normal drill seeding methods.
 - b. Fall seeding is allowed from September 15th until consistent ground freeze, where "consistent ground freeze" is defined as that date on which frozen surface topsoil prevents burying the seed 0.5-inches through normal drill seeding methods.
 - c. Seeding accomplished outside the time intervals listed above may be allowed only when the Contractor's request is approved in writing. The contractor will be responsible for re-seeding, re-mulching, and repairing any areas which fail to produce vegetation.
14. Mulch: Mulch shall be applied after seeding, consisting of long-stemmed weed-free and seed-free straw or hay, applied at a rate of 2-tons per acre. Mulch shall be crimped into the soil surface.
15. Erosion Control Blankets: Erosion Control Blankets shall be applied after seeding on all slopes up to 1:4 gradients. Blankets shall be machine-produced mat with a biodegradable agricultural straw matrix (0.5 lbs/sq yd). The blankets shall have a 12-month typical functional longevity and be designed for use on geotechnically stable slopes and channels with a shear stress up to 0.50 pounds per square foot.
16. Vegetation Establishment: Vegetation will be considered established when all seeded areas are assured of developing a satisfactory stand of growth. Dead spots up to 0.5 square feet in size must not exceed ten percent (10%) of the total seeded area. Dead spots greater than 0.5 square feet shall be re-seeded and freshly re-mulched. The site shall be free of eroded areas and free from infestation of noxious weeds. Upon acceptance of the seeded areas, a 90-day maintenance period will commence. During the maintenance period the Contractor is responsible for all aspects of establishment and maintenance to ensure vigorous and healthy growth of seeded species. The Contractor shall inspect weekly for insect damage, nutrient deficiencies, weeds, and disease and take immediate corrective action. Water the seeded area during the maintenance period only as necessary to maintain a healthy stand of seeded species. Over-watering will not be permitted.
17. Turf areas should be limited to those that can be sustained by natural rainfall or grey water (non-potable) irrigation systems; turf may be defined by at-grade concrete mow strips to lessen maintenance.
18. Analyze soils and provide organic amendments as needed to improve plant growth and conserve water.
19. All plant material shall have one-year warranty and is subject to approval by the Base Architect.

C06.1.5. Water Budgeting (Hydrozones)

Applicable N/A Large graphics do not apply

Applicable N/A Select number of graphics / images (small: 250 px x 188 px) to insert 3

Image Tool 250 x 188



Limited Turf Area Adjacent to Planting Bed



Large Planting Area with Xeric Features



Native Grasses Near Building Entrance

1. Comply with DoD and Air Force policy on potable-water irrigation systems.
2. Provide irrigation systems in new construction to establish plant materials following “Water for Landscaping” in UFC 1-200-02. Note the climate zone and annual rainfall for the locale.
3. Irrigation- Irrigation systems should be zoned so those plant materials with similar water demands are on the same irrigation zone (i.e. high water use turf separated from shrubs and ornamental grasses). Professionally designed and drawn irrigation plans should be an integral part of each new building or landscape plan. The plans should specifically address application methods, natural precipitation, and application rates for the individual zones. Plans also need to indicate tap locations, controller type, type and size of heads, drip methods, type and size of mainline, laterals, water pressure, and meter locations. Hand irrigation by water truck is permitted at Buckley AFB only to establish self-sustaining prairie grasses and Buffalo grass for one year, and only in areas that do not have access to an existing water line.
4. New buildings shall cost-effectively integrate a grey-water reclamation system following UFC 1-200-02, which provides source water for an automatic drip irrigation system; connect adaptive plantings adjacent to facilities to a grey-water irrigation system when available and discontinue the use of potable water for irrigation after the establishment period.
5. Provide irrigation design following UFC 3-201-02. Install drip irrigation products and components following UFGS Section 32 84 24 Irrigation Sprinkler Systems. Match the color of valve box lids to the adjacent ground treatment (i.e. green at turf & native seed areas, brown at wood mulch & rock areas).
6. Life cycle cost-effectively equip irrigation systems to sense soil moisture, rainfall and wind to minimize unnecessary watering; incorporate drip irrigation systems as the primary source.

C06.1.6. Base Entrance Landscaping

Applicable N/A Select number of graphics / images (large: 800 px x 440 px) to insert 1

Image Tool 800 x 440

Applicable N/A Small graphics do not apply



Native Grasses with Limited Tree Planting at Base Entrance

1. At the main gate, reinforce a sense of arrival through a well-designed concentration of landscape elements consistent in visual quality with Facility Group 1.
2. Ensure landscaping has seasonal features with spring and fall color and a combination of evergreen and deciduous trees and shrubs for winter interest.
3. Integrate base signs and street and pedestrian lighting whenever feasible.
4. Typically provide four levels of plants at each gate area:
 - a. Nearest the street, shall be a low ground cover with perennial flower beds or well-manicured turf grass
 - b. Behind this, low shrubs should provide a backdrop
 - c. Ornamental deciduous trees
 - d. Evergreen backdrop shall make up the vertical element at the rear of the planting, located farthest from the street
5. Landscaping at the entrances and along the streetscapes of the installation will develop a strong visual image and provide visual interest during all four seasons. The entrance to the installation creates the first visual impression for the visitor.
 - a. The landscape materials and planting areas will be proportional in scale to the hierarchy of the street on which they are located.
 - b. Landscaping must be integrated with ATRP. Low shrubs, groundcover, annual/perennial plants and canopy trees provide seasonal interest as well as maintain views required to ensure force protection measures. Large evergreen trees are discouraged in these locations because they may obstruct sightlines and impact the need

for force protection. Adequate lines of sight must be maintained for guard personnel to observe vehicular and pedestrian traffic.

6. Xeriscape hydrozones and berming (to elevate and formalize plantings) may be used.
7. North Gate / 6th AveGate Provide a minimum of fifty trees and one hundred shrubs. A minimum of one-half of the required trees and shrubs shall be evergreen. The base entrance landscaping shall be located on both sides of Aspen Street, and shall be located within two hundred feet of the guardhouse. Ground covers shall be provided as a part of the entrance planting, and may include perennial flower beds.
8. South Gate / Mississippi Gate and All Other future Gates: The planting for these gates shall include a minimum of twenty-five trees and fifty shrubs. A minimum of one-half of the required trees and shrubs shall be evergreen. The base entrance landscaping shall be located on both sides of the entrance street, and shall be located within one hundred feet of the guardhouse. Ground covers and perennial flower beds may be provided as a part of the entrance planting.

C06.1.7. Streetscape Landscaping

Applicable N/A Large graphics do not apply

Applicable N/A Select number of graphics / images (small: 250 px x 188 px) to insert 3

Image Tool 250 x 188



Preserved Sight Lines



Xeric Planting Adjacent to Street



Native Grasses along Street

1. Provide landscape designs with plant materials appropriately representing the level of quality of the adjacent Facility Group number. Refer to the Installation Elements section.
2. The use of regionally appropriate street trees shall be incorporated into streetscape design throughout the Installation. Refer to the Installation Elements section.
3. Select a variety of regionally appropriate streetscape plantings and grading to create a visual interest. Refer to the plant selection criteria.
4. Street tree plantings will be used to reinforce vehicular hierarchy, orient and direct traffic, upgrade views, and to visually de-emphasize on-street parking. Also, in the design of a street tree planting, separate plant species may be used to identify distinctive details or areas of the installation (e.g. a particular land use relationship, historical district, community area, or other similar entity).
5. Use formal street trees in single rows to provide continuous shade in the summer to streets, buildings, and walkways and to visually reinforce primary and secondary roads.
6. Use informal groupings of street trees along tertiary routes. Utilize medium size deciduous trees to screen on-street parking along roadways. Set trees 1 to 2 meters (3 to 6 feet) from the back of curbs. Spacing will be uniform, except where curb cuts interrupt regular spacing.

7. As a general rule, street trees will be deciduous species, resistant to salt and root pressure, and will have a 10 feet to 12feet high clearance between the street pavement and branch height to allow adequate clearance for pedestrian and vehicle traffic to pass unimpeded by lower branches.
8. The street tree layout will be coordinated with the layout of proposed street lighting.
9. Appropriate plant heights will be used within sight triangles to ensure safe views from intersections.
10. Weeping trees will not be used in locations where they may hang over the roadway or block views.

C06.1.8. Pedestrian Circulation Landscaping

Applicable N/A Large graphics do not apply

Applicable N/A Select number of graphics / images (small: 250 px x 188 px) to insert 3

Image Tool 250 x 188



Seasonal Color along Sidewalk



Trees and Shrubs as a Focal Point



Ornamental Grasses Defining Space

1. Define walkways with landscaping where appropriate.
2. Provide rest areas along the pedestrian circulation network with human-scaled deciduous shade trees. Supplement tree plantings with finely textured shrubs when appropriate for the climate.
3. Provide wind breaks where required.

C06.1.9. Parking Lot Landscaping

Applicable N/A Large graphics do not apply

Applicable N/A Select number of graphics / images (small: 250 px x 188 px) to insert 3

Image Tool 250 x 188



Landscape Buffers along Street



Native Grasses Adjacent to Lot



Landscape Screening

1. Integrate appropriate landscaping elements into parking areas to visually soften the appearance at a minimum rate of 10 percent of the total area.
2. Avoid trees that drop sap, fruit, or seeds, and use long-lived species; keep trees trimmed, removing dead and dying trees or branches.
3. Provide planting in islands within parking lots for shade and appeal following IFS and the base stormwater management plan.
4. Low Impact Development practices, such as rain gardens and bio swales shall be landscaped to receive rainwater runoff from adjacent impervious parking areas to be absorbed into the ground/planting bed. Native plants and groundcovers are recommended within the rain garden areas, which can survive without supplemental irrigation once established.
5. Rain garden islands shall be designed with all new parking lots that allow rainwater runoff from adjacent impervious parking areas to be absorbed into the ground/planting bed. Native plants and groundcovers are recommended within the rain garden areas, which can survive without supplemental irrigation once established.
6. Parking lots are often the least attractive elements on a military installation. The use of landscape plant material and earth berm can greatly improve the appearance of these areas as well as help define circulation and reduce heat gain during summer months.
7. Use shade tree plantings at parking lots to reduce glare and moderate ambient air temperatures on the lot. Optimum spacing of parking lot shade trees is 4.5 to 9 meters (15 to 30 feet) on center.
8. Choose trees and shrubs that require minimum maintenance and will not litter the parking area with leaves, fruit, or nuts.
9. Consider sight distances near entrances and exits when selecting and placing plant material..
10. Use a mix of evergreen and deciduous plant material to screen parking areas from adjacent uses.
11. Environmental Control Planting. When properly placed, plants can provide environmental benefits, as well as address visual concerns.
12. Use deciduous trees and shrubs at courtyards, buildings and along streets to provide shade, moderate temperatures and reduce glare during the summer months while allowing solar exposure in the winter.
13. Locate deciduous plantings on the southeast and southwest corner of buildings or courtyards to mitigate solar radiation and glare due to heat build-up and lower sun angles in the mid-morning and late afternoon hours.

14. Parking lot drainage could direct flows toward a rain garden, bioswale, or other landscape area that will filter and/or reduce stormwater flows.

C06.1.10. Screen/Accent Landscaping

Applicable N/A Large graphics do not apply

Applicable N/A Select number of graphics / images (small: 250 px x 188 px) to insert 3

Image Tool 250 x 188



Accent Planting



Combined Accent and Screening



Limited Annuals Planting as Accent

1. Provide complimentary accent landscaping at monuments and static displays.
 - a. A minimum of four (4) trees and eight (8) shrubs shall be provided for each displayed item. All plants shall be located within a maximum distance of fifty feet (50') radius of the displayed items.
 - b. Required trees and shrubs shall be placed in groups which are arranged in rhythmic geometric patterns. Trees and shrubs shall be physically separated from turf grass areas.
 - c. Turf grass shall be used as the principal ground plane landscape plant, and shall be located away from the displayed items and on the front viewing side.
 - δ. Limited amounts of perennial flowers, though not required by this guideline, are recommended to provide visual emphasis for these high profile "memorial" type areas.
 - e. The plant palette emphasis for static display areas is to use deciduous trees and evergreen shrubs to provide year around color and texture with seasonal accents. At each separate group of displayed items, limit the number of plant species to maximize visual impact with mass plantings.
2. At Facility Group 1, provide landscaping adjacent to all freestanding signs without distracting from the written communication.
3. Provide landscape screening of utility elements adjacent to Facility Group 1.
4. Providing landscaping as visual screening is preferred to the construction of walls and fences; berming and mounding may supplement landscape screening.
5. All free-standing signs shall be surrounded by appropriate landscaping. This landscaping shall be designed to enhance the sign without detracting from its communication ability.
6. Provide landscape screening of utility elements adjacent to Facility Group 1.

C06.1.11. Other

Applicable N/A Large graphics do not apply

Applicable N/A Small graphics do not apply

1. Open Space Planting:
 - a. Enhance open space areas with planting.
 - b. Use a mix of evergreen, deciduous, and flowering trees.
 - c. Plant the same kind of trees in massive groupings to impact vast open areas.

2. Image Planting: The image of the installation is formed by the visual impressions that exist within the installation.
 - a. The primary locations of highly visible images are the main gate, along primary circulation systems, and at areas of high concentrations of people.
 - b. Features such as signs, statues, static displays, and other primary visual images can be improved by the use of trees, shrubs, and ground cover.

3. Permits & Forms: Prior to performing landscaping work at Buckley AFB the contractor shall:
 - a. Obtain authorization and signatures on a Base Civil Engineering Work Clearance Request (AF 103). From civil engineer customer service desk.
 - b. Obtain a Storm Water Pollution Prevention Permit from base environmental.
 - c. Submit a Notice of Intent (NOI) to the US Environmental Protection Agency.

C07. SITE FURNISHINGS

Comply with AF Corporate Standards for Site Development:

<http://afcs.wbdg.org/site-development/index.html>

Comply with AF Corporate Standards for Site Furnishings:

<http://afcs.wbdg.org/site-development/site-furnishings/index.html>

C07.1. Furnishings and Elements

Applicable N/A Large graphics do not apply

Applicable N/A Small graphics do not apply

1. Provide a coordinated consistent inventory of site furnishings to positively contribute to the visual environment, image, and identity of the base; ensure durability, low maintenance, reduced visual clutter, and compatibility with the adjacent architecture.
2. Remove poorly located or redundant litter / ash receptacles, newspaper and bicycle racks, telephone booths, vending machines, walls and fences to reduce visual clutter and to lessen the requirements for maintenance.
3. Group 1 and 2 site furnishing shall be factory finished steel or concrete. Group 3 and 4 site furnishings shall be factory finished steel or concrete. Generally match the site furniture of adjacent facilities and the facility district.
4. Install needed outdoor seating (benches and low walls) in public gathering spaces near main and secondary building entrances. Low walls shall match facility architecture.
5. Benches in Groups 1, 2 and 3 shall be determined by the designer and approved by the BCE. Provide vinyl-coated aluminum benches in Group 4 and parks.
6. Provide bicycle racks for all Group 1, 2 and 3 facilities throughout Buckley AFB. Use the approved stanchion design or curvilinear design with heavy-duty galvanized steel. Install bicycle lockers only when there is a documented demand for long-term bicycle storage using the base standard system. Locate racks and lockers per ATRP requirements.
7. Maximize the use of boulders, planters, and other landscape site features to comply with AT requirements.
8. Limit the use of bollards, but when necessary for force protection use precast concrete non-illuminated bollards in Groups 1 and 2; steel pipe bollards in Group 3; and decorative aluminum bollards in Group 4 and parks and trails. Illuminated bollards may be used as approved on a case basis; light shields shall be factory finished dark bronze

9. Locate architecturally coordinated containers for recycling, litter, ash, vending, etc., to minimize visual clutter and not visible from the building's main entrance. Minimize the use of freestanding planters.
10. Generally limit picnic tables, barbeque grills and drinking fountains to lodging, dormitories, housing areas, parks and recreation areas following IFS.
11. The Installation Flagpole location shall comply with the guidance for the display of flags in AFI 34-1201. Each Air Force installation is authorized to fly one United States Flag, normally in front of the installation headquarters. Waivers for non-authorized locations must be submitted in accordance with AFI 33-360 and approved waivers (AF Form 679) must be maintained by the installation protocol office.
12. Refer to the Overview Section "Facility Hierarchy" topic of this AFCFS for guidelines regarding ancillary structures such as pavilions and shade shelters.
13. Bus shelters shall be provided only where there is a documented need and when approved on a case basis. Generally emulate the designs of adjacent shelters using factory finished dark bronze metal structure, wall panels and standing seam roofing; glazing shall be dark solar gray/bronze polycarbonate.
14. Monuments and static displays shall be limited. New elements are generally discouraged unless these are fully vetted through the base's approval process and designed following IFS.
15. Temporary storage sheds shall be prohibited. New shed structures will be approved on a case-by-case basis. Storage sheds shall match the adjacent building's architectural character.
16. When visual screening is necessary, consider landscaping as the first option; screen walls are permitted only in Group 1 finished with masonry, precast concrete, stacked stone or steel and detailed to match the adjacent facilities. Do not use concrete masonry units (CMU) as an exposed finish for walls.
17. For fencing, apply the standards for "Products, Materials and Color" in the following section using Styles A, B, C, D, E or F as applicable for the Facility Group number.
18. Do not use chain-link fencing at Group 1, 2 or 4 facilities; Limit the use of barbed-wire outriggers on chain-link fencing at industrial sites, unless required for additional security or protection of assets.
19. Fencing at Facility Group 1 shall be Style D with brick piers, intermittent steel posts, and steel rails and pickets, powder coated dark bronze; Group 2 facilities may use Style B or Style C steel fencing with steel components finished dark brown. Style E fencing may be used for visual screening at Groups 1 and 2. Group 3 fencing may use Style A chain-link with barbed-wire outriggers limited to highest-security assets. Style F rail fences are permitted only in Group 4 and recreational areas.
20. Metal or composite fencing may be used in Facility Group 4 and in recreation areas following IFS for material and finish when there is sustained periodic maintenance.
21. Provide trash dumpster enclosures for Groups 1, 2, and 3 with masonry, precast concrete, natural stone, or steel to match adjacent facilities; all gates shall be metal factory finished Champagne Metallic. All trash enclosures and gates shall meet applicable AT requirements.
22. Specify screen wall materials and finishes that do not require painting or maintenance beyond periodic cleaning.
23. Group 1, 2 and 3 picnic tables and seating shall be precast concrete similar to benches. Group 4 and recreational areas shall have vinyl-coated steel picnic tables and seating in an open mesh design. Generally limit picnic tables, barbeque grills and drinking fountains to lodging, dormitories, housing areas, parks and recreation areas.
24. Limit the use of freestanding planters to areas with ongoing maintenance.
25. Provide marquees and kiosks only where there is a documented need for visual communication of posted messages. When used, match adjacent facilities in materials and detailing and consolidate marquees and kiosks with other site furnishings within 30 feet of major pedestrian paths. Limit marquees and kiosks to facility Groups 1 and 2 and parks.

26. Manufacturers listed below are only provided to establish a baseline of equivalency among all applicable manufacturers.

C07.2. Site Furnishings Products, Materials and Color

Note: Apply the below base-wide standards for Site Furnishings (products, materials and color). Then refer to the Appendix and apply any additional requirements specifically related to the Facility District in which the project is located.

C07.2.1. Barbeque Grills

Applicable N/A

Number of base standards 2

Image Tool 250 x 188



Type: **Charcoal**

Applies to: Group 1 Group 2 Group 3 Group 4 Other

Mfr: Most Dependable Fountains, Inc.

Color: Natural stainless steel

Finish: Mill

Model #: SS BBQ Grill

Other: Concrete foundation, coordinate with Base Architect

UFGS: N/A



Type: **Natural Gas**

Applies to: Group 1 Group 2 Group 3 Group 4 Other

Mfr: BBQ Coach

Color: Natural stainless steel

Finish: Mill

Model #: 32" 4-Burner

Other: Built-in Concrete or masonry, coordinate with Base Architect

UFGS: N/A

C07.2.2. Benches

Applicable N/A

Number of base standards 2

Image Tool 250 x 188



Type: **Precast Concrete**

Applies to: Group 1 Group 2 Group 3 Group 4 Other

Mfr: Materials, Inc.

Color: Weatherstone Gray

Finish: Standard Finish (Smooth)

Model #: Mesa, Rectangular design

Other: N/A

UFGS: N/A

Type: **Factory Finished Metal**

Applies to: Group 1 Group 2 Group 3 Group 4 Other

Mfr: Wabash Valley

Color: Silver or Black

Finish: Powder Coat

Model #: Winchester Collection 6' Memorial Bench with Back, with Arms

Other: Surface Mount

UFGS: N/A



C07.2.3. Bike Racks

Applicable N/A

Number of base standards 1

Image Tool 250 x 188



Type: **Style 1**

Applies to: Group 1 Group 2 Group 3 Group 4 Other

Mfr: Brandir International Inc.

Color: Galvanized

Finish: Factory

Model #: The Ribbon Bike Rack, RB-07

Other: N/A

UFGS: N/A

C07.2.4. Bike Lockers

Applicable N/A

C07.2.5. Bollards

Applicable N/A

Number of base standards 3

Image Tool 250 x 188



Type: **Lighted Square Sloped Top**

Applies to: Group 1 Group 2 Group 3 Group 4 Other

Mfr: Kim Lighting

Color: Platinum Silver

Finish: Anodized aluminum

Model #: VSB1 Square

Other: 3000K LED Lamp, 360° downlighting

UFGS: N/A



Type: **Lighted Round Dome Top**

Applies to: Group 1 Group 2 Group 3 Group 4 Other

Mfr: Lithonia Lighting Products

Color: Dark Bronze

Finish: Anodized aluminum

Model #: KBA

Other: Flared cone, 3000K LED Lamp

UFGS: N/A

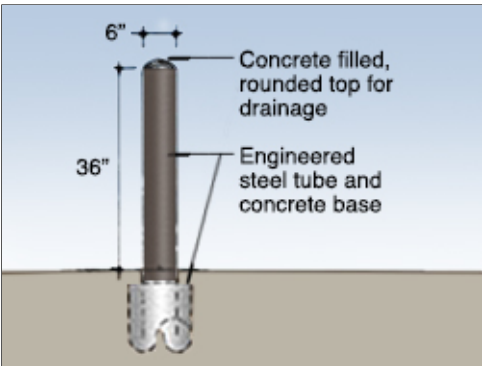

Type: **Building Protection, steel**

Applies to: Group 1 Group 2 Group 3 Group 4 Other

Mfr: (Bollard Cover) Reliance Foundry

Color: Brown cover may be field painted dark bronze

Finish: Factory

Model #: 6" Steel pipe, concrete filled, Cover: R-7173

Other: A 1" (25.4 mm) rigid conduit and box with shroud may be provided at top of bollard with a receiver/key switch application

UFGS: N/A

C07.2.6. Bus Shelters

Applicable N/A

Number of base standards 1

Image Tool 250 x 188



Type: **1**

Applies to: Group 1 Group 2 Group 3 Group 4 Other

Mfr: Global Sources

Color: Silver

Finish: stainless steel/ galvanized sheet

Model #: GSBS0001

Other: Provide concrete slab and 2 pre-manufactured stainless steel/ galvanized sheet. Roofing: tempered glass/galvanized sheet or <http://www.streetscapes.biz/bus-shelter-interlude-p-15208.html>

UFGS: <http://www.globalsources.com/gsol/l/Bus-shelter/p/sm/1156633784.htm>

C07.2.7. Drinking Fountains

Applicable N/A

Number of base standards 1

Image Tool 250 x 188



Type: **Pedestal**

Applies to: Group 1 Group 2 Group 3 Group 4 Other

Mfr: Most Dependable Fountains, Inc.

Color: Natural

Finish: Stainless Steel

Model #: MDF 440 SMSS

Other: Accessible

UFGS: N/A

C07.2.8. Dumpster Enclosures / Gates

Applicable N/A

Number of base standards 2

Image Tool 250 x 188

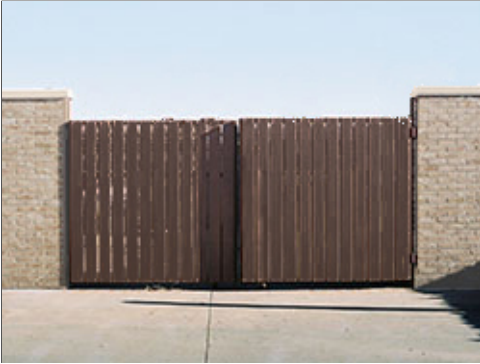

Type: **1: Brick and Steel**

Applies to: Group 1 Group 2 Group 3 Group 4 Other

Mfr: Custom

Color: Beige brick blend, dark brown doors

Finish: Face brick, powder coated doors

Model #: Match adjacent building

Other: Steel gates and hardware, dark brown, dumpsters shall be painted dark brown

UFGS: Section 04 20 00 Unit Masonry

Type: **2: Concrete and Steel**

Applies to: Group 1 Group 2 Group 3 Group 4 Other

Mfr: Custom

Color: Exposed Aggregate (Pikes Peak Granite)

Finish: Medium Texture (or media blasted)

Model #: Sheet-formed with exposed-tie reveals or board-formed concrete

Other: (Match adjacent building)
Gates, galvanized or powder-coated silver

UFGS: SECTION 03 33 00 Cast-In-Place Architectural Concrete



C07.2.9. Fencing

Applicable N/A

Number of base standards 7

Image Tool 250 x 188

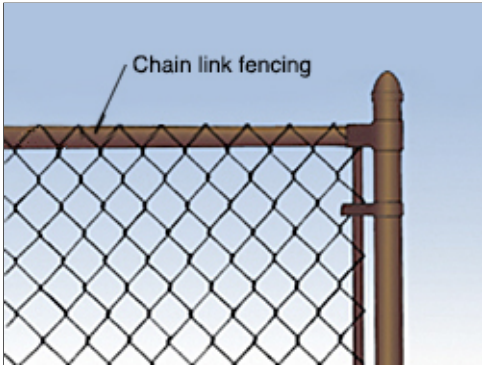

Type: **Style A Barrier: High security, low visibility**

Applies to: Group 1 Group 2 Group 3 Group 4 Other

Mfr: General Wire Co.

Color: Dark brown

Finish: PVC coating over galvanized steel

Model #: Chain link, steel posts and rails, gates and accessories

Other: N/A

UFGS: Section 32 31 13 Chain Link Fences and Gates

Type: **Style B Barrier: High security, medium visibility**

Applies to: Group 1 Group 2 Group 3 Group 4 Other

Mfr: Custom

Color: Dark brown

Finish: Powder coat

Model #: Steel grid: flat bar stock verticals, round rod horizontals

Other: Steel posts, horizontal bars, braces, and accessories, in heights, lengths, and gauges as required; Close all ends of tubing

UFGS: Section 05 50 13 Miscellaneous Metal Fabrications

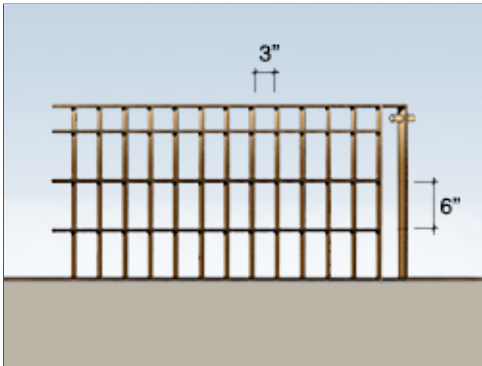

Type: **Style C Barrier: Medium security, medium visibility**

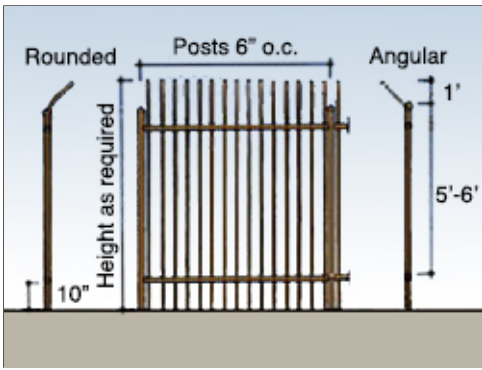

Applies to: Group 1 Group 2 Group 3 Group 4 Other

Mfr: Custom

Color: Dark Brown

Finish: Powder coat

Model #: Steel posts, rails and pickets (vertical, bent outward at top)

Other: Posts, rails, and pickets in heights, lengths and gauges as required, (see Appendix for Facility Districts requirements)

UFGS: Section 05 50 13 Miscellaneous Metal Fabrications

Type: **Style D Barrier: Low security, High visibility**

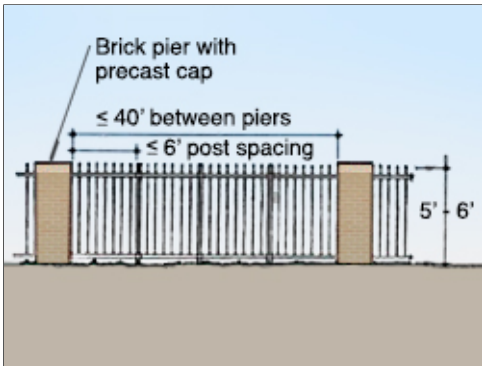

Applies to: Group 1 Group 2 Group 3 Group 4 Other

Mfr: Custom

Color: Beige brick blend, dark brown fencing

Finish: Face brick, powder coated metal

Model #: Brick Piers with steel posts, rails and pickets

Other: Brick: 2'x2' (Height as required, equally spaced 12' to 40'), Steel posts: 4"x4" (equally spaced), Rails: 2"x2", Pickets: 1"x1" (6" o.c.); close all ends of tubing

UFGS: Section 04 20 00 Unit Masonry, Section 05 50 13 Misc. Metal

Type: **Style E Barrier: Low security, High visibility**

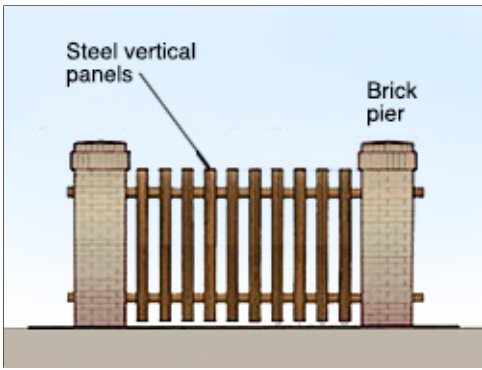

Applies to: Group 1 Group 2 Group 3 Group 4 Other

Mfr: Custom

Color: Beige brick blend, dark brown fencing

Finish: Powder coated metal

Model #: Brick Piers with steel posts, rails and alternating panels

Other: Brick: 2'x2' (Height as required, equally spaced 8' to 40'), Steel posts: 4"x4" (equally spaced), Rails: 1-1/4"x1-1/2", vertical steel panels spaced alternately on each side of the rails; matching gates; close all ends

UFGS: Section 04 20 00 Unit Masonry, Section 05 50 13 Misc. Metal

Type: **Style F Barrier: Very low security, high visibility**



Applies to: Group 1 Group 2 Group 3 Group 4 Other

Mfr: Custom

Color: Integral mixed Davis Colors: dark warm gray

Finish: Factory

Model #: Post and rail

Other: Concrete 3-rail, wood-grain textured (4,000 psi at 28 days); Posts: 39" height, 8' spacing, set 30" deep below grade with footing, typical

UFGS: SECTION 03 33 00 Cast-In-Place Architectural Concrete

Type: **Style G Barrier (Alternate): Very low security, high visibility**



Applies to: Group 1 Group 2 Group 3 Group 4 Other

Mfr: James Hardie Building Products, Inc.

Color: Off white and Earth tones

Finish: Factory

Model #: Post and rail with vertical boards

Other: Posts: Height as required, 8' max. spacing; apply boards to outside face.

UFGS: Not Available (SECTION 074646 Fiber Cement Siding)

C07.2.10. Flagpoles

Applicable N/A

Number of base standards 1

Image Tool 250 x 188

Type: **1**

Applies to: Group 1 Group 2 Group 3 Group 4 Other

Mfr: Eder Flag

Color: Natural aluminum

Finish: Satin Lustre

Model #: ECL30 IH, Internal Halyard

Other: 5" Butt Dia. 33' H (30' Exposed)

UFGS: N/A



C07.2.11. Lighting – Landscape / Accent

Please refer to the Lighting section.

C07.2.12. Litter and Ash Receptacles

Applicable N/A

Number of base standards 2

Image Tool 250 x 188



Type: **Style 1: Precast concrete**

Applies to: Group 1 Group 2 Group 3 Group 4 Other

Mfr: Materials, Inc.

Color: Weatherstone Gray

Finish: Smooth

Model #: TR-3225 Sante Fe (round or square)

Other: Rigid plastic internal liner,
http://materialsinc.com/wp-content/uploads/2014/10/TR-3225_SANTA_FE.pdf

UFGS: N/A

Type: **Style 2: Metal**

Applies to: Group 1 Group 2 Group 3 Group 4 Other

Mfr: Wabash Valley

Color: Black or as approved

Finish: Perforated Pattern

Model #: Urbanscape "E" with liner, 32 Gallon

Other: With dome top, without side door

UFGS: N/A



C07.2.13. Picnic Tables

Applicable N/A

Number of base standards 2

Image Tool 250 x 188



Type: **Precast concrete**

Applies to: Group 1 Group 2 Group 3 Group 4 Other

Mfr: Materials, Inc.

Color: Weatherstone Gray

Finish: Standard Finish (Smooth)

Model #: TS-3490 New Mexican

Other: (303) 458-9595

UFGS: N/A

Type: **Metal, vinyl coated**

Applies to: Group 1 Group 2 Group 3 Group 4 Other

Mfr: Wabash Valley

Color: Brown or as approved

Finish: Factory vinyl coated

Model #: Signature Series, 46" Square Pedestal Tables with 4 Seats

Other: Perforated Pattern, In-ground mount

UFGS: N/A



C07.2.14. Planters

Applicable N/A

Number of base standards 1

Image Tool 250 x 188

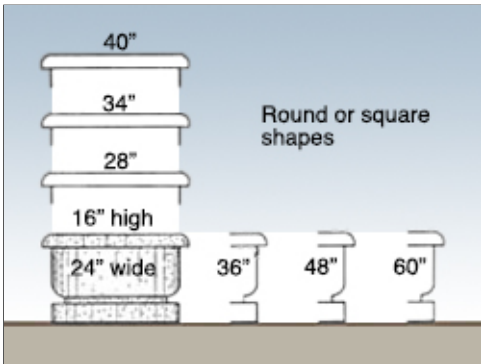

Type: **Precast concrete**

Applies to: Group 1 Group 2 Group 3 Group 4 Other

Mfr: Materials, Inc.

Color: Weatherstone Gray

Finish: Smooth

Model #: Santa Fe

Other: N/A

UFGS: N/A

C07.2.15. Play Equipment

Applicable N/A

Number of base standards 1

Image Tool 250 x 188



Type: **Steel**

Applies to: Group 1 Group 2 Group 3 Group 4 Other

Mfr: Little Tikes Commercial

Color: Varies

Finish: Powdercoated Steel

Model #: N-R-G Freestyle

Other: Coordinate with Base Architect

UFGS: N/A

C07.2.16. Screen Walls

Applicable N/A

Number of base standards 1

Image Tool 250 x 188

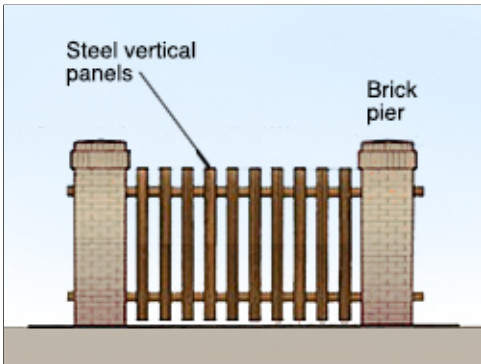

Type: **Brick / Steel**

Applies to: Group 1 Group 2 Group 3 Group 4 Other

Mfr: Custom

Color: Beige brick blend, dark brown fencing

Finish: Powder coated metal

Model #: Brick Piers with steel posts, rails and alternating panels

Other: Brick: 2'x2' (Height as required, equally spaced 8' to 40'), Steel posts: 4"x4" (equally spaced), Rails: 1-1/4"x1-1/2", vertical steel panels spaced alternately on each side of the rails; matching gates; close all ends

UFGS: Section 04 20 00 Unit Masonry, Section 05 50 13 Misc. Metal

C07.2.17. Tree Grates

Applicable N/A

Number of base standards 1

Image Tool 250 x 188



Type: **Cast Iron**

Applies to: Group 1 Group 2 Group 3 Group 4 Other

Mfr: Neenah Enterprises, Inc.

Color: Natural cast iron

Finish: Cast

Model #: 2-Piece, round or square

Other: N/A

UFGS: N/A

C07.2.18. Other

Applicable N/A

C08. EXTERIOR SIGNS

Comply with AF Corporate Standards for Site Development:

<http://afcs.wbdg.org/site-development/index.html>

Comply with AF Corporate Standards for Exterior Signs:

<http://afcs.wbdg.org/site-development/exterior-signs/index.html>

C08.1. Colors and Types

Applicable N/A Large graphics do not apply

Applicable N/A Small graphics do not apply

1. Provide concise functional signs as a visually unifying element with consistent colors and types for all Installation and Gate Identification Signs; Building Identification Signs; Traffic Control Devices; Directional and Wayfinding Signs; and Informational and Motivational Signs.
2. Provide signs with the lowest overall life cycle costs considering initial cost, ongoing maintenance and lifespan while meeting quality standards. Follow IFS for specifications appropriate for the local climate to withstand weathering.
3. Reduce the number of signs, reduce visual clutter and provide only essential signs required for identification, directions, instructions, and customer service following UFC 3-120-01. Remove non-conforming signs during renovation projects.
4. Provide only one freestanding Building Identification Sign for facility. Typically provide "Primary" signs for Group 1, "Secondary" signs for Group 2, and "Tertiary" signs for Group 3 and recreational areas following UFC 3-120-01.
5. Maintain the existing Installation and Gate Identification Signs and "Colorado theme" in color, lettering, materials and construction methods and match these in future entrance signs. Follow UFC 3-120-01 for sign layout and content. No unit names, unit mottos, or names and titles of individuals are permitted.
6. Group 2 and 3 facilities shall have wall mounted facility signs with sizes and layouts following UFC 3-120-01. Signs are not permitted for Group 4 facilities.
7. Display of emblems on building exterior walls or other permanent structures is prohibited by UFC.
8. Raised "standout" letters and numbers may be used for Group 1 with approval on a case basis.
9. Only one identification sign is permitted at each building entrance. Include a building address consistent with US Postal Service protocols following UFC 3-120-01.
10. Traffic Control Devices, which regulate vehicular traffic on the installation, shall conform to the standards in the Manual of Uniform Traffic Control Devices (MUTCD) published by the Federal Highway Administration. Coordinate street signs with this IFS.
11. Provide Directional and Wayfinding Signs and address both pedestrian and vehicular traffic following UFC 3-120-01 for size, layout and content.
12. Reserved parking signs should be kept to a minimum and assignment of reserved spaces should be established through the installation approval process. The use of freestanding and building-mounted signs is discouraged.
13. Parking lot identification signs may be used to identify areas or rows within large lots.
14. Follow the guidelines and requirements in ABAAS and the MUTCD for accessible parking signs.
15. Follow UFC 3-120-01 for Informational and Motivational Signs for size, layout and content.

16. Symbols or pictographs (graphic expressions of actual objects) may be used to indicate service, mandatory / prohibitory, sports, and recreation when rapid communication is necessary.
17. Force Protection signage may be applied to glass doors using white vinyl lettering. The sign shall be oval in shape with a ¼" white border. FP CON lettering shall be 1 3/8" Arial Bold with the words "REAL" and "EXERCISE" letter in ¾" Arial Regular lettering spaced accordingly. The bottom of this lettering shall be placed at the midpoint of border.
18. Refer to UFC 3-120-01 for prohibited signs, which include those with animated, blinking, chasing, flashing, or moving effects.
19. Manufacturers listed below are only provided to establish a baseline of equivalency among all applicable manufacturers.
20. To reduce costs, Buckley AFB prefers to fabricate signs in house where possible. This has been successful in saving money and creating a consistent aesthetic thread throughout the base. See destination signage for dimensional requirements.

C08.1.1. Materials and Color Specifications

Applicable N/A Large graphics do not apply

Applicable N/A Small graphics do not apply

1. Fabricate sign panels from aluminum sheet, minimum 12 gauge, for durability. Sign posts shall be powder-coated steel with capped ends in a concrete base.
2. Fence mounted sign panels may be attached with exposed fasteners.
3. Sign posts and panel sizes must be engineered by the sign contractor according to the wind loads and other requirements at each installation.
4. All signage shall be provided using the following standard colors:
 - a. Standard Blue: FHA #3, Highway Blue; SW 2940, Bridgeport (N); FSC X5180
 - b. Standard Dark Bronze: Federal Specification 30040
 - c. Standard Red: FHA #3, Highway Red; SW 2910, Red Door (PC); FSC X1086
 - d. Standard Black: FHA Black (non-reflective); SW 2119, Umbrella Black (C); FSC X7038
 - e. Standard White: FHA White; SW 2423, Polar White (TWT); FSC X7925
 - f. Buckley Air Force Brown: Federal Specification 10091.

Type: **Typical Sign Base**

Applies to: Group 1 Group 2 Group 3 Group 4 Other

Mfr: Custom

Color: Natural Gray

Finish: Sonotube-formed

Model #: 24" height x 12" diameter, as engineered.

Other: At grade with 3/4" chamfer. Provide engineered sizes.

UFGS: UFGS 03 30 00 Cast-in-place Concrete

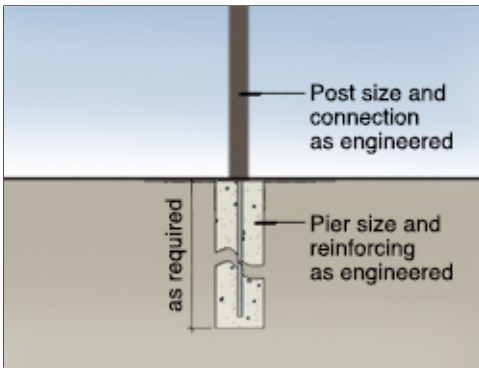

C08.1.2. Installation and Gate Identification Signs

Applicable N/A Number of base standards 1

Image Tool 250 x 188

Type: **Primary, Secondary and Tertiary (Uses per UFC)**

Applies to: Group 1 Group 2 Group 3 Group 4 Other

Mfr: Custom

Color: Dark bronze, brushed aluminum, accents per UFC

Finish: Powder coat or vinyl sign face

Model #: Metal frame and panels, buff stone base

Other: White vinyl lettering. Provide dimensions per UFC. Secondary signs shall match primary sign's materials, but shall be smaller in size per UFC. Tertiary signs shall follow the UFC.

UFGS: Section 05 50 13 Miscellaneous Metal Fabrications

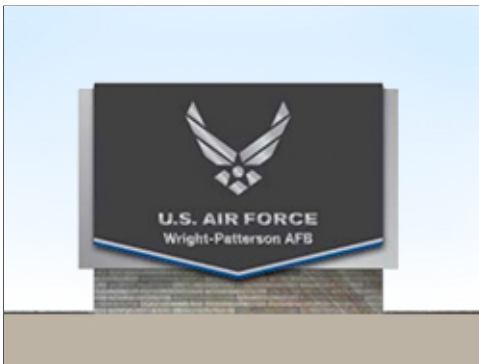

C08.1.3. Building Identification Signs

Applicable N/A

Number of base standards 5

Image Tool 250 x 188

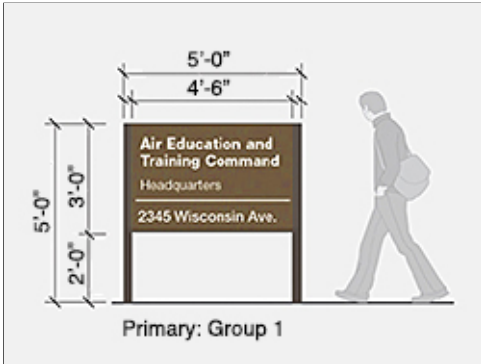

Type: **Freestanding Primary Sign (Sizes and Uses per UFC)**

Applies to: Group 1 Group 2 Group 3 Group 4 Other

Mfr: Custom

Color: Medium brown face, dark bronze posts, white vinyl lettering

Finish: Powder coat or vinyl sign face

Model #: Aluminum sheet face, extruded aluminum posts

Other: Provide layout and sizes per UFC.

UFGS: Section 05 50 13 Miscellaneous Metal Fabrications

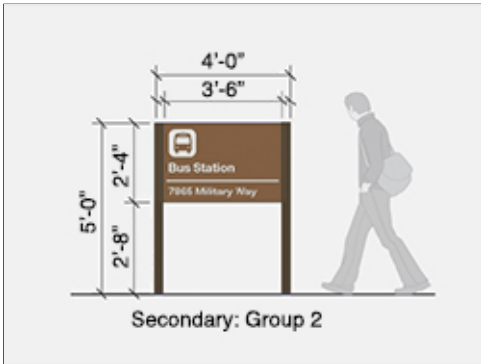

Type: **Freestanding Secondary Sign (Sizes and Uses per UFC)**

Applies to: Group 1 Group 2 Group 3 Group 4 Other

Mfr: Custom

Color: Medium brown face, dark bronze posts, white vinyl lettering

Finish: Powder coat or vinyl sign face

Model #: Aluminum sheet face, extruded aluminum posts

Other: Provide layout and sizes per UFC.

UFGS: Section 05 50 13 Miscellaneous Metal Fabrications

Type: **Freestanding Tertiary Sign (Sizes and Uses per UFC)**

Applies to: Group 1 Group 2 Group 3 Group 4 Other

Mfr: Custom

Color: Medium brown face, dark bronze posts, white vinyl lettering

Finish: Powder coat or vinyl sign face

Model #: Aluminum sheet face, extruded aluminum posts

Other: Provide layout and sizes per UFC.

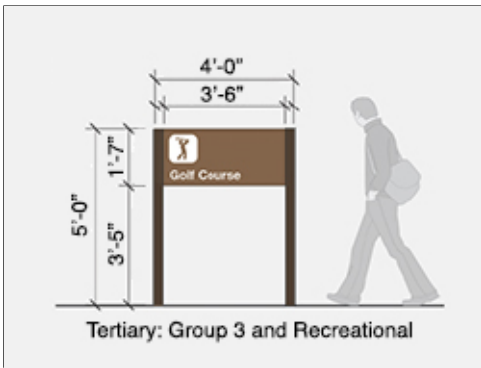

UFGS: Section 05 50 13 Miscellaneous Metal Fabrications

Type: **Wall Mounted**

Applies to: Group 1 Group 2 Group 3 Group 4 Other

Mfr: Custom

Color: Medium brown, white lettering

Finish: Satin vinyl applied to aluminum sheet

Model #: Aluminum sheet with vinyl face and vinyl lettering

Other: Provide layout and sizes following UFC.

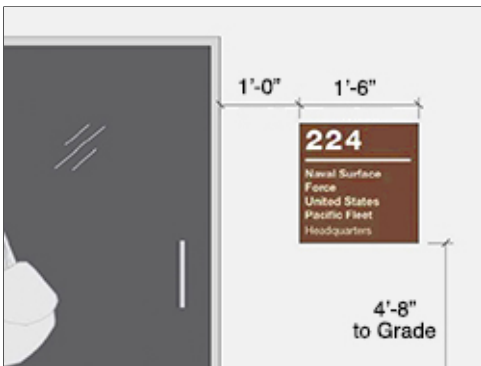

UFGS: N/A

Type: **Glass Mounted**



Applies to: Group 1 Group 2 Group 3 Group 4 Other

Mfr: Custom

Color: White vinyl lettering

Finish: Matte vinyl

Model #: Machine-cut sheet vinyl

Other: Apply vinyl lettering to glass. Provide sizes following UFC.

UFGS: N/A

C08.1.4. Traffic Control Devices (Street Signs)

Applicable N/A Number of base standards 1

Image Tool 250 x 188



Type: **Street Signs**

Applies to: Group 1 Group 2 Group 3 Group 4 Other

Mfr: Custom

Color: White reflective lettering on a Standard Brown background

Finish: Powder coat or vinyl sign face

Model #: Aluminum sign face, control arm or pole mounted

Other: Mount 7' above grade minimum, pictographs and logos are prohibited on street name signs per UFC.

UFGS: Section 05 50 13 Miscellaneous Metal Fabrications

1. Maintain streets signs as the most important directional signage on the base with consistent color and layout conforming to UFC-3-120-01.

2. Provide White reflective lettering on a Standard Brown background for street signs. Note that pictographs and logos are prohibited on street name signs per UFC.

3. Determine the length of the sign by the number of letters in the street name. Always use a single line of text. Use capital and lower case lettering. Capital letters shall be seven inches (7", 177.8mm) high. Provide a 1/2" (12.7mm), white rule line around the sign edge (insert 1" (25.4mm) from the edge of metal). Do not abbreviate street names, but it is acceptable to shorten street types such as Boulevard (Blvd.), Street (St.), and Avenue (Ave.).

4. Street signs shall be mounted at each intersection on the horizontal member of the streetlight, or on poles fifteen feet from the curb line. The tops of signs mounted on poles shall be seven feet (7'-0", 2.13m) off the ground. They should be located away from trees or other obstructions.

C08.1.5. Directional and Wayfinding Signs

Applicable N/A Number of base standards 2

Image Tool 250 x 188



Type: **Vehicular**

Applies to: Group 1 Group 2 Group 3 Group 4 Other

Mfr: Custom

Color: Medium brown face, dark bronze posts, white reflective lettering

Finish: Powder coat or vinyl sign face

Model #: Aluminum sheet face, extruded aluminum posts

Other: Conform to the requirements of the MUTCD and its DoD Supplement. Provide types and sizes where required by UFC.

UGFS: Section 05 50 13 Miscellaneous Metal Fabrications

Type: **Pedestrian**

Applies to: Group 1 Group 2 Group 3 Group 4 Other

Mfr: Custom

Color: Medium brown face, dark bronze posts

Finish: Powder coat or vinyl sign face

Model #: Aluminum sheet face, extruded aluminum posts

Other: White vinyl lettering. Provide types and sizes where required by UFC.

UGFS: Section 05 50 13 Miscellaneous Metal Fabrications

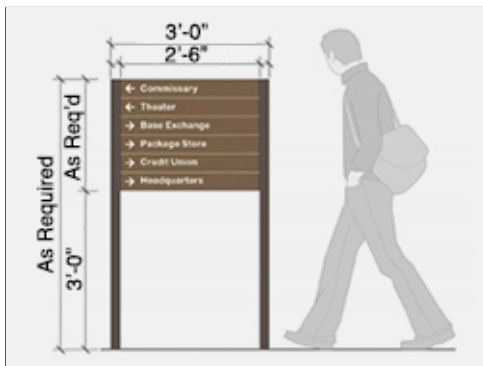

C08.1.6. Informational Signs

Applicable N/A Large graphics do not apply

Applicable N/A Small graphics do not apply

1. Minimize informational signs such as static display signs, hours of operation, and project signs to reduce visual clutter.
2. Static display signs shall have standard brown background.

- Hours of operation signs shall have a level of quality equivalent to the Facility Group number.
- Temporary / Project Signage shall be judiciously placed to avoid visual clutter. Schedule and arrange for the removal of these signs prior to installation.

C08.1.7. Motivational Signage

Applicable N/A Large graphics do not apply

Applicable N/A Small graphics do not apply

- Provide professionally produced motivational signs as important elements of campaigns to boost morale, improve safety, aid in recruiting, and accomplish other motivational objectives. Consolidate this signage to reduce visual clutter.
- Motivational signs shall be limited to an electronic "marquee" type changeable sign near each gate. Temporary signs are not permitted. Motivational information may also be posted in a small, printed format on kiosks in specified, high pedestrian use areas. Refer to kiosks under Site Furnishings.
- Follow UFC 3-120-01 for color and layout. Note that animated, blinking, chasing, flashing, or moving effects are prohibited by the UFC.
- Mount marquee signs on reinforced concrete bases with a natural warm gray color.

C08.1.8. Parking Lot Signs

Applicable N/A

- Whenever possible, limit the number of parking signs by "bracketing" multiple reserved parking spaces. Use the "bracketing" approach for three (3) or more contiguous spaces. For one (1) or two (2) spaces, use individual signs at each space. The signs will only indicate Disabled or General Reserved. Individual space information, i.e. "CO" or "NCO OF THE MONTH" will be painted on the curb as per AFPAM 32-1099, except that the letters shall be white on a Standard Light Brown (PMS #168c) background.
- Follow the guidelines and requirements in ABAAS and the MUTCD for accessible parking signs.
- Use parking lot identification signs to identify areas or rows within large parking lots over 100 spaces or two double rows of parking.

C08.1.9. Regulatory Signs

Applicable N/A

- Regulatory signage, which restricts, warns and advises, shall be limited to those mandated under Highway/Traffic, Government Warning, and/or Parking Regulation. Follow UFC 3-120-01 and its industry references for color and layout.
- Provide a comprehensive, systematic approach to regulatory signage to avoid clutter and confusion from "over signage."
- Traffic control signs shall be used only where required to regulate vehicular traffic as described in the Manual of Uniform Traffic Control Devices (MUTCD) published by the Federal Highway Administration. The IFS does not control this type of signage.
- Maintain base warning signs for safety and security at the base perimeter and at specific secure areas. Use these to notify visitors of restrictions governing conduct on the base, as well as other security procedures.
- Hazardous waste signs shall be reflective Peterson Brown backgrounds with 1" upper case Helvetica white lettering. Emblems are not authorized. These signs may be fence mounted.

C08.1.10. Other

Applicable N/A

C09. LIGHTING

Comply with AF Corporate Standards for Site Development:
<http://afcs.wbdg.org/site-development/index.html>

Comply with AF Corporate Standards for Lighting:
<http://afcs.wbdg.org/site-development/lighting/index.html>

C09.1. Fixtures and Lamping

Applicable N/A Large graphics do not apply

Applicable N/A Select number of graphics / images (small: 250 px x 188 px) to insert 3

Image Tool 250 x 188



Coordinated Site and Facility Lighting



Indirect Wall-Mounted Fixtures



Coordinated Interior and Exterior Lighting

1. Provide, coordinate and efficiently install street, parking lot, sidewalk and facility lighting with appropriate luminaires, lamping, placement and spacing following UFC 3-530-01 and Installation Facilities Standards (IFS); ensure the level of quality is consistent with the adjacent facility group number. Pole-mounted, wall-mounted and bollard fixtures are permitted.
2. Integrate controls to automatically reduce lighting power during periods of non-activity; automatically turn off power when sufficient daylight is available. Follow IECC latest version.
3. Ensure continuity and consistency of lighting elements. In new construction generally match post types, fixture types, styles, heights, sizes, materials, colors, and lamp types of adjacent facilities and the facility district.
4. Economically provide renewable-energy power sources such as solar photovoltaic when feasible.
5. Use appropriately designed or shielded luminaires to direct light downward to minimize light pollution and intrusion onto adjacent sites and to facilitate night training. All exterior luminaires shall be full cutoff and comply with International Dark-Sky Association guidelines.
6. Calculate and provide with all drawing sets illuminance levels for all lighting applications following UFC 3-530-01 and ensure compliance with pre-curfew maximum brightness level requirements.

7. Sufficiently address environmental factors to prevent corrosion and weathering of fixtures, plinths and other components.
8. Wall mounted fixtures should respond to the architectural character of the facility.
9. Efficient accent lighting of architectural and landscape features may be provided for Group 1, lodging and historical applications. Accent lights in ground-mounted locations may be provided for static displays and signs when these do not conflict or cause hazards with overhead aircraft.
10. Comply with UFC 3-530-01 for light source technology and lamp types. All new and replacement luminaires shall be provided with LED lamps.
11. Provide round tapered, square non-tapered, or round non-tapered aluminum poles and aluminum fixtures with square, rectangular or circular housings in colors and shapes to match adjacent facilities and the facility district.
12. Install lighted bollards only at Group 1 and high-traffic Group 2 facilities. Generally match materials, colors and shapes of adjacent facilities and the facility district.
13. Install natural warm gray color, smooth finished concrete bases for all poles in heights appropriate for the facility group and application. Generally Groups 1, 2 and 4 shall have at-grade bases. Group 3 shall have taller bases for added durability.
14. When parking lot lighting is necessary, provide an illuminated path to the building's main entrance. , providing an average of 1.0 ft-candles at ground level and not less than 0.2 ft-candles at any point along the walkway. Pole bases should be contained within an internal landscape median or island.
15. Consistently install lighting for sidewalks, bikeways and trails to match adjacent facilities.
16. Landscape accent lighting may be used in public gathering spaces and in Group 1 facilities. Coordinate the design, luminaire selection, and placement with the location of trees, shrubs, and site furnishings.
17. Manufacturers listed below are only provided to establish a baseline of equivalency among all applicable manufacturers.

C09.2. Light Fixture Types

Note: *Apply the below base-wide standards for Light Fixtures (products, materials and color). Then refer to the Appendix and apply any additional requirements specifically related to the Facility District in which the project is located.*

C09.2.1. Street Lighting

Applicable N/A

Number of base standards 2

Image Tool 250 x 188

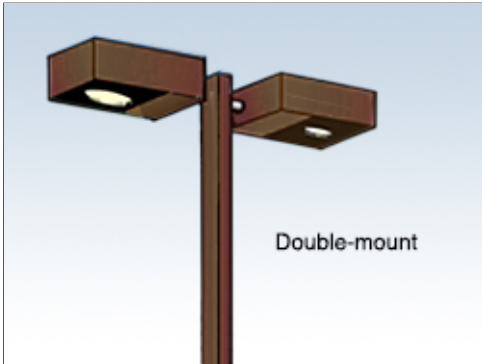

Type: **Style 1**

Applies to: Group 1 Group 2 Group 3 Group 4 Other

Mfr: Hubbell, Kim Lighting

Color: Dark Bronze Anodized (or Clear Anodized as approved by BCE)

Finish: Factory

Model #: Rectilinear Cutoff, Single Arm or Dual Arm Mount

Other: Lamp: LED. Follow manufacturer's recommendations for fixture base.

UFGS: N/A

Type: **Style 2**

Applies to: Group 1 Group 2 Group 3 Group 4 Other

Mfr: Hubbell, Kim Lighting

Color: Clear Anodized as approved by BCE

Finish: Factory

Model #: Round Cutoff, Single Arm or Dual Arm Mount

Other: Lamp: LED. Follow manufacturer's recommendations for fixture base.

UFGS: N/A

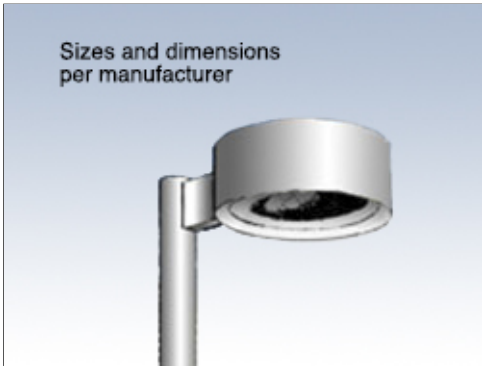

C09.2.2. Parking Lot Lighting

Applicable N/A

Number of base standards 2

Image Tool 250 x 188

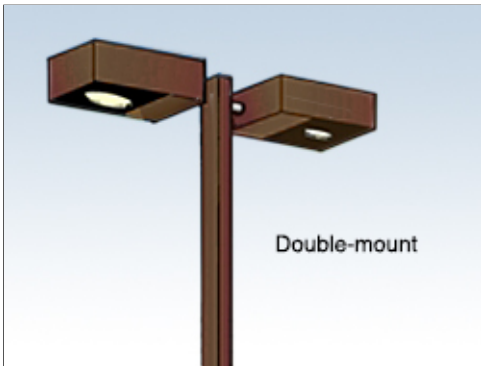

Type: **Parking Lot Style 1**

Applies to: Group 1 Group 2 Group 3 Group 4 Other

Mfr: Hubbell, Kim Lighting

Color: Dark Bronze Anodized (or Clear Anodized as approved by BCE)

Finish: Factory

Model #: Rectilinear or Round Cutoff, Single Arm or Dual Arm Mount

Other: Lamp: LED. Follow manufacturer's recommendations for fixture base.

UFGS: N/A

Type: **Parking Lot Fixture Base**

Applies to: Group 1 Group 2 Group 3 Group 4 Other

Mfr: Custom

Color: Natural gray

Finish: Trowel

Model #: Form-cast, round

Other: N/A

UFGS: Section 03 33 00 Cast-In-Place Architectural Concrete

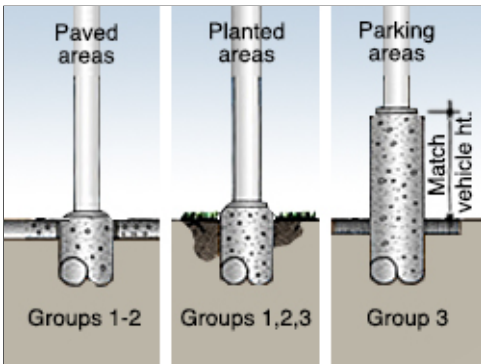

C09.2.3. Lighted Bollards

Applicable N/A

Number of base standards 2

Image Tool 250 x 188



Type: **Lighted Round Dome Top**

Applies to: Group 1 Group 2 Group 3 Group 4 Other

Mfr: Lithonia Lighting Products

Color: Dark Bronze

Finish: Anodized aluminum

Model #: KBA

Other: Flared cone, 3000K LED Lamp. Follow manufacturer's recommendations for fixture base.

UFGS: N/A



Type: **Lighted Square Sloped Top**

Applies to: Group 1 Group 2 Group 3 Group 4 Other

Mfr: Kim Lighting

Color: Platinum Silver

Finish: Anodized aluminum

Model #: VSB1 Square

Other: 3000K LED Lamp, 360° downlighting

UFGS: N/A

C09.2.4. Sidewalk Lighting

Applicable N/A

Number of base standards 1

Image Tool 250 x 188

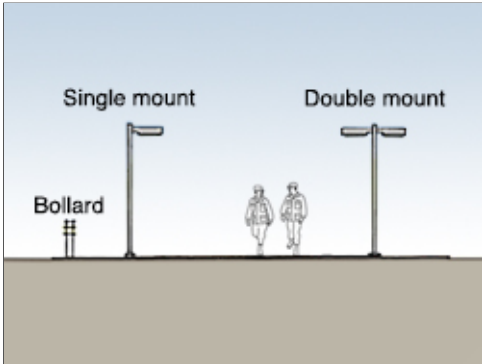

Type: **Rectilinear Cutoff**

Applies to: Group 1 Group 2 Group 3 Group 4 Other

Mfr: Hubbell, Kim Lighting

Color: Dark Bronze Anodized (or Clear Anodized as approved by BCE)

Finish: Anodized aluminum

Model #: Rectilinear Cutoff, Single Arm or Dual Arm Mount

Other: Lamp: LED. Follow manufacturer's recommendations for fixture base.

UFGS: N/A

C09.2.5. Walls / Stairs Lighting

Applicable N/A

Number of base standards 1

Image Tool 250 x 188



Type: **Style 1**

Applies to: Group 1 Group 2 Group 3 Group 4 Other

Mfr: Vista Lighting

Color: Dark bronze anodized

Finish: Smooth

Model #: Aluminum Step and Brick Lights, 5230 round louvered

Other: Lamp: LED

UFGS: N/A

C09.2.6. Other

Applicable N/A

D. FACILITIES EXTERIORS

Comply with Air Force Corporate Standards for Facilities Exteriors:

<http://afcs.wbdg.org/facilities-exteriors/index.html>

Applicable N/A Select number of graphics / images (large: 800 px x 440 px) to insert 1

Image Tool 800 x 440

Applicable N/A Select number of graphics / images (small: 250 px x 188 px) to insert 3

Image Tool 250 x 188



Buckley AFB Rocky Mountain Lodge Plaza and Amenities for Four Season Use



Understated Materials Palette



Contemporary Features



Group 4 Architectural Features

D01. SUPPORTING THE MISSION

Comply with AF Corporate Standards for Supporting the Mission:

<http://afcs.wbdg.org/facilities-exteriors/supporting-the-mission/index.html>

D02. SUSTAINABILITY

Comply with Air Force Corporate Standards for Sustainability:

<http://afcs.wbdg.org/facilities-exteriors/supporting-the-mission/index.html>

D03. ARCHITECTURAL FEATURES

Comply with AF Corporate Standards for Facilities Exteriors:

<http://afcs.wbdg.org/facilities-exteriors/index.html>

Comply with AF Corporate Standards for Architectural Features:

<http://afcs.wbdg.org/facilities-exteriors/architectural-features/index.html>

Insert 3 photos for each facility group.

Image Tool 250 x 188

Group 1



Group 2



Group 3



Group 4



D03.1. Orientation, Massing and Scale

1. Orient new buildings to maximize energy efficiency, passive solar and daylighting potential of the building; narrow buildings oriented along an east-west axis are preferred to minimize heat gain in the summer months and maximize heat gain in the winter months resulting in less overall energy usage.
2. Provide orthogonal geometry for principal building form; angular geometry may be used sparingly for Group 1 and used only for emphasis at specific areas such as building entrances and stairwells.
3. Maintain a human scale and reduce the visual scale of large buildings with sub-massing related to interior functional operations; create consistent form and scale in adjacent buildings with compatible profiles or silhouettes.
4. Building heights shall not be limited; however, building heights over 2 stories shall be considered on a case basis.
5. Combine functions where practical to avoid a proliferation of small, independent structures.
6. Use and coordinate shading devices with orientation and for function.

D03.2. Architectural Character

1. Develop architectural features, materials and detailing appropriate for the Facility Group designation. Refer to Building Entrances, Wall Systems and Roof Systems.
2. Respond to the local climate and regional influences with environmentally functional architectural features.
3. For new facilities design generally maintain consistency and visual unity in the character of the adjacent buildings through compatible architectural features: repeated use of similar forms such as roofs, and through recurring elements such as doors, windows, materials and colors.
4. Reinforce the campus environment and space surveillance theme with a related architectural theme expressive of innovation and technology that represents the current Air Force Space Command mission.
5. All facilities shall express sustainability through their orientation, massing, shape, form, materials, and detailing. Provide louvers, fins and other shading devices to control heat gain and glare and to and improve energy efficiency.
6. Strive for economical construction without compromising a high-quality, professional appearance.

D03.3. Details and Color

1. Provide a palette of earth-tone colors related to the native landscape in brick, block, stucco and powder-coated metals. Refer to wall systems for detailed material listings.
2. Relate the level of architectural detailing to the Facility Group number.
3. Use only integrally colored materials as the predominant exterior building material; do not use materials that require field painting and ongoing maintenance.
4. Provide consistent and compatible colors for every exterior building feature, including walls, roofs, doors, windows, gutters, downspouts, utility and mechanical elements, and other visible elements.
5. Noncorrosive metals with factory applied color finishes are required.
6. Combine details and color with orientation, massing, scale and architectural character to maintain base compatibility.
7. Manufacturers listed below are only provided to establish a baseline of equivalency among all applicable manufacturers.

D03.3.1. Climate-based Data and Life-Cycle Cost-Effective Passive and Natural Design Strategies:

- Climate dominated by mechanical cooling
- Climate dominated by mechanical heating
- Climate with similar mechanical cooling / heating needs
- Climate with minimal mechanical cooling / heating needs

- Climate with high humidity
- Climate with moderate humidity
- Climate with low humidity

- High Solar Insolation
- Moderate Solar Insolation
- Low Solar Insolation

- Soils with High Thermal Conductivity
- Soils with Average Thermal Conductivity
- Soils with Low Thermal Conductivity

Other:

Other:

Facility: Narrow buildings along E-W axis are preferred

Wall: Integral shading features and devices / interior masonry thermal mass walls (for heating)

Doors: Recessed are preferred

Windows: Limit north-facing windows / maximize windows on south façades with shading

Roof: High to medium albedo, minimal to moderate slope

Structure: Do not expose ferrous metals. Provide factory finished non-ferrous metals or concrete

MEP: Ground-source and solar photovoltaic following LCCA

Other: Optimize shading devices to provide summer shade and allow winter solar heat gain

Other: Internal thermal mass walls may be used for heating following LCCA

Note: Apply the below *base-wide standards* for Architectural Features (products, materials and color). Then refer to the Appendix and apply any additional requirements specifically related to the Facility District in which the project is located.

D03.3.2. Natural Ventilation System

Applicable N/A

Number of base standards 1

Image Tool 250 x 188



Type: **Style 1 Aluminum Windows**

Applies to: Group 1 Group 2 Group 3 Group 4 Other

Mfr: Kawneer (or equivalent)

Color: Dark Bronze (or clear anodized) as approved by BCE

Finish: Anodized

Model #: 2x4, slider or awning type

Other: Provide thermally broken frames.

UFGS: Section 08 41 13 Aluminum-Framed Entrances and Storefronts

D03.3.3. Thermal Mass

Applicable N/A

Number of base standards 1

Image Tool 250 x 188



Type: **Style 1 Interior Wall Material**

Applies to: Group 1 Group 2 Group 3 Group 4 Other

Mfr: Custom, TBD

Color: Beige brick or CMU blend

Finish: Light texture

Model #: Coursed unit masonry

Other: Brick is preferred. Concrete block may only be used in Group 3 when approved by the BCE.

UFGS: Section 04 20 00 Unit Masonry

D03.3.4. Thermal Shading

Applicable N/A

Number of base standards 1

Image Tool 250 x 188



Type: **Style 1 Wall Devices**

Applies to: Group 1 Group 2 Group 3 Group 4 Other

Mfr: Kawneer (or equivalent) or custom

Color: Dark bronze

Finish: Factory, to match frames

Model #: Louver

Other: Shading devices may be attached to frames or structure

UFGS: Section 08 41 13 Aluminum-Framed Entrances and Storefronts

D03.3.5. Renewable Heating/Cooling

Applicable N/A

Number of base standards 1

Image Tool 250 x 188

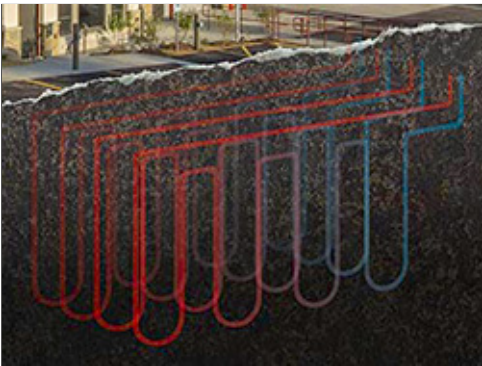

Type: **Style 1 Geothermal (Ground Source)**

Applies to: Group 1 Group 2 Group 3 Group 4 Other

Mfr: Climate Master

Color: N/A

Finish: N/A

Model #: N/A

Other: Vertical ground loop well field

UFGS: Section 23 81 47 Water-Loop and Ground-Loop Heat Pump Systems

D03.3.6. Solar Photovoltaic System

Applicable N/A

D03.3.7. Solar Thermal System

Applicable N/A

D04. BUILDING ENTRANCES

Comply with AF Corporate Standards for Facilities Exteriors:

<http://afcs.wbdg.org/facilities-exteriors/index.html>

Comply with AF Corporate Standards for Building Entrances:

<http://afcs.wbdg.org/facilities-exteriors/building-entrances/index.html>

Insert 3 photos for each facility group.

Image Tool 250 x 188

Group 1



Group 2



Group 3



Group 4



D04.1. Primary Entrances

1. Emphasize the primary entrance in the overall building design with a projecting or recessed covering for weather protection following Installation Facilities Standards (IFS) for Facility Group designations.
2. Group 1 entrances shall be identified by the use of wall plane changes, vertical elements, or similar manipulation of entrance design elements and/or changes in materials.
3. Group 2 entrances may have adjacent pedestrian gathering space to enhance a sense of entrance to facilities.
4. Express primary building entrances as the focal point of the façade and align these with pedestrian access points. Locate main building entrances on south facades whenever possible.
5. All south facing entrances shall be recessed a minimum of four feet (4') (1.22 m) from the adjacent exterior wall planes, providing protection from the wind and sun.
6. When north-facing facades are along the pedestrian area create an entrance feature into a transitional space then direct users to east-facing or west-facing building entrances.
7. Provide vestibules at entries in Groups 1, 2 and 3 unless used infrequently or serving unconditioned space following ASHRAE 90.1.
8. Fully integrate all elements including the design of handicap ramps in the overall design of the primary entrance in an organized uncluttered appearance.
9. Install paved transitional spaces sized for the building function and occupancy.
10. Install appropriate lighting and site furniture following ATFP and IFS.
11. Protect entrances in cold climates from falling ice and snow.
12. Provide covered drop-offs when justified for lodging and medical facilities; do not use for prestige or architectural accents.
13. Protect entrances from falling ice and snow.
14. Provide porte cocheres or covered drop-offs when justified for lodging and medical facilities; do not use for prestige or architectural accents.

D04.2. Secondary Entrances

1. Provide vestibules at entries in Groups 1, 2 and 3 unless used infrequently or serving unconditioned space following ASHRAE 90.1; use of stair towers as vestibules for multi-story buildings is encouraged when building and / or energy codes are satisfied.
2. Reflect the character of the primary entrance to a lesser extent with a smaller scale.
3. Integrate secondary entrances with free-standing shading systems on the east and west ends of buildings for weather protection and shading.
4. Include a recess or projection for weather protection and shading.
5. Integrate service and egress doors and loading areas with the building design by matching the materials and detailing and reflect the overall quality of the facility.
6. Incorporate egress structures such as stair towers into the facility design.
7. Canopies may be used for service and loading areas; weather protection beyond weatherstripping is not required at doors used only for life safety egress.

8. Develop building massing and orientation to minimize the appearance of service and loading areas; physically and visually separate these from primary entrances.
9. Loading areas must be organized, orderly and have an uncluttered appearance.

D05. WALL SYSTEMS

Comply with AF Corporate Standards for Facilities Exteriors:

<http://afcs.wbdg.org/facilities-exteriors/index.html>

Comply with AF Corporate Standards for Doors and Windows:

<http://afcs.wbdg.org/facilities-exteriors/wall-systems/index.html>

Comply with AFCFS Recommended Materials:

<http://afcs.wbdg.org/facilities-exteriors/wall-systems/materials/index.html>

Insert 3 photos for each facility group.

Image Tool 250 x 188

Group 1



Group 2



Group 3



Group 4



D05.1. Hierarchy of Materials

1. Group 1 facilities may have more refined detailing than Group 2 and Group 2 may have more definition than Group 3.
2. Group 1 and 2 facilities shall be a combination of Stone Veneer Masonry (color/type approved on project basis) and architectural precast. Masonry, metal wall panel and curtain wall systems may be used also. Stone Veneer Masonry, CMU Best Block #773 (or approved equivalent) and insulated metal wall panel systems is acceptable for Group 3 facilities and inconspicuous areas of Group 2 facilities. Refer to the Appendix for special requirements of Facility Districts.
3. Group 4 shall match the materials in Peak View Estates. Provide a combination of two of the following materials: brick, stucco, and horizontal siding.
4. Multi-story Group 1 facilities may include a transition in material, color or detailing to create a visual base. Generally limit Stone Veneer Masonry, glazing and insulated metal panel system to a single color on Group 2, 3 and 4 facilities.
5. Use high-performance building envelopes following UFC 1-200-02.
6. Use detailing not subject to excessive weathering. Provide wall accents consistently throughout the base.
7. Use integrally colored materials and factory-finished metals. Do not paint concrete block.
8. Translucent wall panels may be used in Facility Group 1 and recreational uses in Group 2 when protected from direct solar gain. Provide insulating panels and shading appropriate for the orientation and exposure.
9. Manufacturers listed below are only provided to establish a baseline of equivalency among all applicable manufacturers.

D05.2. Layout, Organization and Durability

1. Organize wall components including doors, windows, accents, shading devices, control joints, etc., to provide an ordered, professional appearance.
2. Integrate shading devices into the overall composition of the wall.
3. Integrate fixed shading devices as at all exterior glazing exposed to summer UV heat gain as a passive design measure to reduce energy use. Ensure adequate shading at west entrances. Deciduous trees may be used for shading.
4. Shading systems may be included as part of a manufacturer's window system or may be custom systems integrated into the wall.
5. Provide appropriate transitions between dissimilar materials to mitigate effects of thermal expansion and galvanic action.
6. All joint sealants shall be slightly darker than adjacent surfaces.
7. Materials requiring regular maintenance are not permitted.
8. Refer to C07.2.16. Screen Walls for materials and colors of freestanding walls.
9. Refer to D07. Roofs for downspouts.

D05.3. Equipment, Vents and Devices

1. Arrange all mechanical, electrical, fire alarm, lightning protection and other system components to create an orderly appearance that integrates with the wall system.
2. Do not expose conduits, cables, piping, lightning protection components, etc. on exterior walls; if unavoidable in renovations, finish these elements to match the adjacent wall surface.

3. Avoid visual clutter and where surface-mounted elements are required they shall match the wall color.

D05.4 Wall Systems Materials

Facility Group 1 wall materials shall be as follows.

Primary: Masonry and Architectural Precast
Secondary: Curtainwall Systems and Cast-in-Place Concrete
Accent: Optional: (with brick) Metal Panels

Facility Group 2 wall materials shall be as follows.

Primary: Masonry and Architectural Precast
Secondary: Metal Wall Panel and Cast-in-Place Concrete
Accent: N/A

Facility Group 3 wall materials shall be as follows.

Primary: Metal Wall Panel Systems
Secondary: Masonry (CMU) or Cast-in-Place Concrete
Accent: Translucent Wall Panel

Facility Group 4 wall materials shall be as follows.

Primary: Masonry
Secondary: Metal wall panels
Accent: Concrete or Brick Foundation Cladding

Note: Apply the below base-wide standards for Wall Systems (products, materials and color). Then refer to the Appendix and apply any additional requirements specifically related to the Facility District in which the project is located.

D05.4.1. Flat Metal Panels

Applicable N/A Number of base standards 1

Image Tool 250 x 188



Type: **Style 1**

Applies to: Group 1 Group 2 Group 3 Group 4 Other

Mfr: Alucobond

Model #: Alucobond Classic, Rainscreen I

Color: Anodic Clear Mica PVDF 2

Finish: Anodized

Other: Route and Return Dry Seal

UFGS: Section 07 42 13 Metal Wall Panels:
http://www.wbdg.org/FFC/DOD/UFGS/UFGS_07_42_13.pdf
Section 07 42 63 Fabricated Wall Panel Assemblies:
http://www.wbdg.org/FFC/DOD/UFGS/UFGS_07_42_63.pdf

D05.4.2. Brick Veneer

Applicable N/A

Number of base standards 1

Image Tool 250 x 188



Type: **Style 1**

Applies to: Group 1 Group 2 Group 3 Group 4 Other

Mfr: Local, TBD

Model #: Modular Face Brick

Color: Beige blend

Finish: Straight Edges, smooth texture

Other: Nominal size: 4x8x2.6

UFGS: Section 04 20 00 Unit Masonry:

<http://www.wbdg.org/FFC/DOD/UFGS/UFGS 04 20 00.pdf>

D05.4.3. Architectural Precast

Applicable N/A

Number of base standards 1

Image Tool 250 x 188



Type: **Coursed precast**

Applies to: Group 1 Group 2 Group 3 Group 4 Other

Mfr: Local, TBD

Model #: Smooth Casting

Color: Light Beige

Finish: Very Light texture

Other: N/A

UFGS: Section 03 45 00 Precast Architectural Concrete:

<http://www.wbdg.org/FFC/DOD/UFGS/UFGS 03 45 00.pdf>

D05.4.4. Stucco Over Sheathing

Applicable N/A

Number of base standards 1

Image Tool 250 x 188



Type: **3-Coat Cementitious Stucco**

Applies to: Group 1 Group 2 Group 3 Group 4 Other

Mfr: La Habra

Model #: Traditional 3-coat system

Color: Beige

Finish: Sand

Other: Accent color may be used

UFGS: Section 09 24 23 Cement Stucco:

http://www.wbdg.org/FFC/DOD/UFGS/UFGS_09_24_23.pdf

D05.4.5. Curtain Wall

Applicable N/A

Number of base standards 1

Image Tool 250 x 188



Type: **Rain Screen**

Applies to: Group 1 Group 2 Group 3 Group 4 Other

Mfr: Kawneer

Model #: 1600 Wall System

Color: Clear Anodized Frames / Blue Glazing

Finish: Factory

Other: N/A

UFGS: Section 08 44 00 Curtain Wall and Glazed Assemblies:

http://www.wbdg.org/FFC/DOD/UFGS/UFGS_08_44_00.pdf

D05.4.6. Cast-In-Place Concrete

Applicable N/A Number of base standards 1

Image Tool 250 x 188



Type: **Board-Formed Bearing Walls**

Applies to: Group 1 Group 2 Group 3 Group 4 Other

Mfr: Custom

Model #: Rough-sawn dimensional lumber forming

Color: Natural gray concrete

Finish: Board-formed texture exposed, no exposed form ties

Other: Clear sealer may be applied

UFGS: Section 03 33 00 Cast-In-Place Architectural Concrete:
<http://www.wbdg.org/FFC/DOD/UFGS/UFGS 03 33 00.pdf>

D05.4.7. Tilt-Up Concrete

Applicable N/A Number of base standards 1

Image Tool 250 x 188



Type: **Modular Panelized System**

Applies to: Group 1 Group 2 Group 3 Group 4 Other

Mfr: Local TBD

Model #: Site cast panels

Color: Natural gray concrete

Finish: Smooth liner form

Other: N/A

UFGS: Section 03 47 13 Tilt-Up Concrete:
<http://www.wbdg.org/FFC/DOD/UFGS/UFGS 03 47 13.pdf>

D05.4.8. Ribbed Metal Sheeting

Applicable N/A Number of base standards 1

Image Tool 250 x 188



Type: **Flush Seam**

Applies to: Group 1 Group 2 Group 3 Group 4 Other

Mfr: Berridge

Model #: Flush Seam Panel

Color: Beige

Finish: Embossed Texture, factory finished

Other: 24 Gauge Steel

UFGS: Section 07 42 13 Metal Wall Panels:
<http://www.wbdg.org/FFC/DOD/UFGS/UFGS 07 42 13.pdf>

D05.4.9. EIFS

Applicable N/A

D05.4.10. GFRC

Applicable N/A

D05.4.11. Concrete Block

Applicable N/A Number of base standards 2

Image Tool 250 x 188

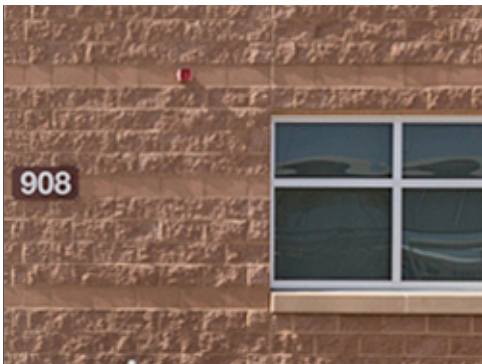

Type: **Concrete Masonry Unit (CMU) Split Face**

Applies to: Group 1 Group 2 Group 3 Group 4 Other

Mfr: Local TBD

Model #: 8x8x16 Nominal, face and corner units

Color: Light or medium beige

Finish: Heavy Texture

Other: N/A

UFGS: Section 04 20 00 Unit Masonry:
<http://www.wbdg.org/FFC/DOD/UFGS/UFGS 04 20 00.pdf>

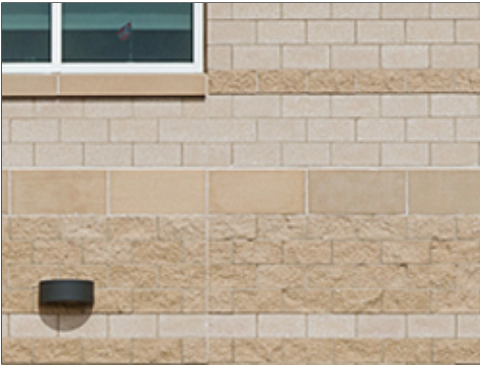

Type: **Concrete Masonry Unit (CMU) Ground Face**

Applies to: Group 1 Group 2 Group 3 Group 4 Other

Mfr: Local TBD

Model #: 8x8x16 nominal, face and corner units

Color: Light or medium beige

Finish: Ground with exposed aggregate

Other: N/A

UFGS: Section 04 20 00 Unit Masonry:
<http://www.wbdg.org/FFC/DOD/UFGS/UFGS 04 20 00.pdf>

D05.4.12. Fiber Cement Siding

Applicable N/A Number of base standards 1

Image Tool 250 x 188



Type: **Style 1**

Applies to: Group 1 Group 2 Group 3 Group 4 Other

Mfr: James Hardie Building Products, Inc.

Model #: Horizontal Lap Siding, Shingle Siding

Color: Earth Tones

Finish: Wood Texture

Other: Hardie Plank, Hardie Shingle

UFGS: SECTION 074646 Fiber Cement Siding:
(Not Available on UFGS)

D05.4.13. Other

Applicable N/A

D06. DOORS AND WINDOWS

Comply with AF Corporate Standards for Facilities Exteriors:

<http://afcs.wbdg.org/facilities-exterior/index.html>

Comply with AF Corporate Standards for Doors and Windows:

<http://afcs.wbdg.org/facilities-exterior/doors-and-windows/index.html>

Comply with AFCFS Recommended Materials:

<http://afcs.wbdg.org/facilities-exterior/doors-and-windows/materials/index.html>

Insert 3 photos for each facility group.

Image Tool 250 x 188

Group 1



Group 2



Group 3



Group 4



D06.1. Types

1. Clear anodized aluminum or patrician bronze doors, windows and frames with thermal breaks are preferred for Facility Groups 1-3. Door and frame shall match in color and finish. For renovation projects, the color of new windows, doors and frames may match the existing ones.
2. Operable windows are permitted in Group 1, 2, 3, and 4 where applicable.
3. Aluminum clad wood windows are preferred for Facility Group 4.
4. Standard-sized hinged doors are preferred. Use sliding, folding, overhead, sectional and other door configurations only to support mission operations.
5. Automatic doors are allowed only where functionally necessary.
6. Limit hollow metal doors and frames to security doors, utility rooms and mechanical rooms in Groups 1 and 2 and to any application in Group 3 facilities.
7. Utility and emergency egress doors shall match the wall color.
8. Passive thermal comfort methods of ventilation are encouraged where life cycle cost justified.
9. Windows and openings must meet force protection requirements.
10. Adjacent joint sealants should be slightly darker than the frame color.
12. Manufacturers listed below are only provided to establish a baseline of equivalency among all applicable manufacturers.

D06.2. Layout and Geometry

1. Visually and functionally compose openings in walls for the climate-specific exposure. Utilize south-facing windows to facilitate energy-saving strategies.
2. Consistently use opening type, size, placement, mullion pattern, and color to reinforce the overall architectural design.
3. Openings shall augment interior lighting and space conditioning needs.
4. Protect against vandalism, intrusion and coordinate sound ratings.

D06.3. Glazing and Shading

1. Provide 1" insulating glass at all window and door applications, tempered where required by code, and laminated safety glass at sloped applications. Install 1/4" glass at spandrel panel (opaque) locations.
2. All window and door glass shall be medium gray in color of the manufacturer's standard tint, visible light transmittance of 42% and shading coefficient of 0.64 for 1/4" thick glass. Insulating glass units: daylight transmittance - 40% maximum, daylight reflectance (outdoors) - 8% maximum, shading coefficient (no shade) - 0.60 maximum.
3. Provide High Solar Heat Gain Coefficient (SHGC) dual-pane glazing where interior thermal mass walls and operable insulating curtains are installed.
4. Translucent wall panels may be integrated into wall systems.
5. Do not use mirrored glazing.
6. Fully integrate applicable shading designs for overhangs, louvers, light shelves and grilles.

7. Where appropriate, install window screens to take advantage of natural ventilation.

D06.4. Hardware

1. Provide hardware appropriate for the Facility Group while considering activity and frequency of use and local climate; hardware may be of higher visual quality for Facility Group 1.
2. Ensure hardware will perform throughout the facility's lifespan without showing extreme wear.
3. Select finishes that will not degrade by intensity of operation or exposure to the elements.
4. Use consistent finishes and color on window and door systems throughout a facility. For renovation projects the color of new hardware may match the existing hardware.
5. Design building systems to eliminate the need for security screens whenever possible.

D06.5. Doors and Windows Materials

Note: Apply the below base-wide standards for Doors and Windows (products, materials and color). Then refer to the Appendix and apply any additional requirements specifically related to the Facility District in which the project is located.

D06.5.1. Anodized Aluminum

Applicable N/A Number of base standards 1

Image Tool 250 x 188



Type: **Anodized Aluminum Doors, Windows and Frames**

Applies to: Group 1 Group 2 Group 3 Group 4 Other

Mfr: Kawneer (or equivalent)

Color: Dark Brown Anodized

Finish: Matte

Model #: 2x4

Other: Provide thermally broken frames

UFGS: Section 08 41 13 Aluminum-Framed Entrances and Storefronts:
<http://www.wbdg.org/FFC/DOD/UFGS/UFGS 08 41 13.pdf>

D06.5.2. Hollow Metal

Applicable N/A

Number of base standards 1

Image Tool 250 x 188



Type: _____

Applies to: Group 1 Group 2 Group 3 Group 4 Other

Mfr: Hollow Metal Doors, Windows and Frames

Color: Dark Brown

Finish: Powder Coated, Satin

Model #: 2x4 frame

Other: Provide thermally broken frames

UFGS: Section 08 11 13 Steel Doors and Frames:

<http://www.wbdg.org/FFC/DOD/UFGS/UFGS 08 11 13.pdf>

D06.5.3. Aluminum-clad Wood

Applicable N/A

Number of base standards 1

Image Tool 250 x 188



Type: **Aluminum-clad Residential**

Applies to: Group 1 Group 2 Group 3 Group 4 Other

Mfr: Marvin

Color: White or Earth tones

Finish: Powder coated, satin

Model #: Aluminum-clad wood windows

Other: Double hung

UFGS: Section 08 14 00 Wood Doors

<http://www.wbdg.org/FFC/DOD/UFGS/UFGS 08 14 00.pdf>

D06.5.4. Other

Applicable N/A

D07. ROOF SYSTEMS

Comply with AF Corporate Standards for Facilities Exteriors:

<http://afcs.wbdg.org/facilities-exteriors/index.html>

Comply with AF Corporate Standards for Roof Systems:

<http://afcs.wbdg.org/facilities-exteriors/roof-systems/index.html>

Comply with AFCFS Recommended Materials:

<http://afcs.wbdg.org/facilities-exteriors/roof-systems/materials/index.html>

Insert 3 photos for each facility group.

Image Tool 250 x 188

Group 1



Group 2



Group 3



Group 4



D07.1. Roof Type and Form

1. Use proven, cost-effective roof systems with high durability, weather resistance, and low maintenance that are compatible with Installation Facilities Standards (IFS) and requirements for the designated Facility Group.
2. Generally match the roof type and form of existing adjacent facilities in new construction.
3. Group 1 and 2 buildings shall use sloped standing seam metal roofs. Built-up roofing systems may be used only for repair and maintenance of existing as approved on a case basis.
4. Provide screens for roof-mounted appendages and equipment of the same materials, which are used predominantly in the building's roof systems.
5. Roof translucent panels are permitted in Groups 1, 2, and 3. (materials and type).
6. Group 2 and 3 facilities under 5,000 sf and narrow in plan geometry, may use low-sloped shed, gabled, or membrane roof systems roofs. Larger facilities may use sloped-roof features in conjunction with predominantly minimal-sloped "flat" membrane roofs.
7. Group 4 facilities may have sloped composite shingle roofing.
8. Roof eaves shall extend beyond the exterior wall for roof drainage and shading. Provide overhangs for shading in response to local climatic conditions, sized and proportioned to the height of the facility and to the window openings being shaded.
9. South-facing eaves shall coordinate with adjacent wall-mounted shading devices.
10. The color, shape and slope of the eave and soffit shall be compatible with adjacent facilities.
11. Keep roofs uncluttered and minimize penetrations.
12. Diminish massive roofs into coordinated smaller components consistent with adjacent facilities; avoid random, arbitrary changes.
13. Increase the insulation value of existing roofing systems during renovations if supported by life cycle cost and structural analysis.
14. Roofs shall be maintained for the life of the system and replaced in accordance with UFC 3-110-04 and AFI 32-1051. A warranty is required on all new roofs.
15. Manufacturers listed below are only provided to establish a baseline of equivalency among all applicable manufacturers.

D07.2. Roof Slope

1. Group 1 and 2 buildings shall use sloped roofs, min. 3:12.
2. Low-sloped roofs are allowed for larger structures or to match existing conditions on renovation projects. Minimal-sloped roofs may also be used for Group 3 facilities in high-visibility areas.
3. Group 4 facilities that incorporate sloped roofs may use 4:12 for sloped roofs.
4. Ensure adequate drainage, and connect to the subsurface rain collection system where available.
5. Provide roof slopes to accommodate solar photovoltaic, solar thermal, passive systems and daylighting when applicable following UFC 1-200-02.
6. Provide underlayments as required for the roofing type as directed by the UFC.

D07.3. Parapets and Copings

1. Extend wall materials vertically above the roof line and provide metal copings to match the wall. Ensure copings are properly flashed and detailed to avoid roof leaks.

D07.4. Color and Reflectivity

1. Light gray, medium bronze or dark bronze sloped roofs may be used in Groups 1 and 2 and smaller facilities in Group 3.
2. All minimal-slope membrane roofs shall use only use high-albedo, high reflectivity color to help decrease the temperature around the buildings and minimize damage to human and wildlife habitat.
3. Sloped roofs in Group 4 shall be Earth tones.
4. Comply with UFC 3-110-03 and ASHRAE 90.1 for Solar Reflectance Index (SRI) and thermal requirements.
5. All roof flashing shall match the color of the predominant background material.

D07.5. Gutters, Downspouts, Scuppers, Drains

1. All sloped roofs shall use gutters and downspouts. Gutters shall be outside the fascia.
2. Internal roof drainage systems are not permitted in new construction. Minimal-sloped roofs shall be sloped to drain to the building perimeter through scuppers into downspouts.
3. All gutters and fascias shall match the roof color.
4. Size the roof drainage system per IBC and SMACNA for the region.
5. Use scuppers as required in parapet walls. Arrange scuppers in an orderly manner consistent with other elements of the wall system.
6. When open scuppers are connected to downspouts, provide transitions consistent with adjacent facilities.
7. Integrate downspouts with the architectural details of the wall system and arrange in an orderly, non-prominent appearance. Generally blend downspouts with the color of the wall (not contrasting it).
8. Fabricate downspouts from non-corrosive materials such as aluminum or zinc-coated steel. Provide powder-coated finishes in medium bronze.
9. All downspouts shall be solid.
10. Provide angled transitional pieces for downspouts to fit closely against the wall for their entire length.
11. Coordinate locations of downspouts to conceal control joints in masonry walls when possible.
12. Place downspouts away from building entries. Water discharged should not run across sidewalks.

D07.6. Roof Vents and Elements

1. Minimize and consolidate roof penetrations into a single, inconspicuous point whenever possible.
2. On sloped roofs clad pipe penetrations to match the roofing material.
3. Avoid the use of rooftop mechanical equipment, however for renovations and unavoidable configurations ensure units are screened.

4. Provide access points and service routes to equipment that protect the roof.
5. Screen all large vents.
6. Ensure attic spaces are properly vented at ridges and soffits.
7. Match roof color for all exposed equipment and vents.
8. Avoid roof-mounted antenna systems.
9. Arrange Lightning Protection Systems (LPS) components in an ordered, uncluttered, inconspicuous appearance and integrated into the organization of the roof and wall systems.
10. Ensure that LPS roof mounting systems are approved by the roofing manufacturer.
11. Additions to a roof shall not interfere with LPS or other rooftop systems that may be required.
12. Permanent fall protection shall be included with any addition to a roof with a slope above 3:12 per UFC 3-110-03 to a roof with a slope above 3:12 per UFC 3-110-03.

D07.7. Clerestories and Skylights

1. Clerestories and skylights are permitted in Group 1 facilities. These are allowed in Group 3 facilities only when serving passive systems and are justifiable by life-cycle analysis.
2. Clerestories are preferred to skylights to avoid roof penetrations. Skylights, when permitted, must be simple in shape and integrated with the roof system to eliminate leakage.
3. Design clerestories and skylights using the same principles for seasonal shading that are required for walls and roof overhangs.
4. Translucent panel systems are preferred in clerestory applications due to lack of window cleaning.
5. Clerestories and skylights must comply with UFC 4-10-01.

D07.8. Vegetated Roof

1. Not applicable.

D07.9. Roof Systems Materials

Note: Apply the below base-wide standards for Roof Systems (products, materials and color). Then refer to the Appendix and apply any additional requirements specifically related to the Facility District in which the project is located.

D07.9.1. Standing Seam Metal

Applicable N/A

Number of base standards 1

Image Tool 250 x 188



Type: **Style 1**

Applies to: Group 1 Group 2 Group 3 Group 4 Other

Mfr: Berridge

Color: Champagne Metallic or other as approved by the BCE

Finish: Matte

Model #: Tee-Panel

Other: Shed, gabled or hipped standing seam metal

UFGS: Section 07 61 14 Steel Standing Seam Roofing
<http://www.wbdg.org/FFC/DOD/UFGS/UFGS 07 61 14.00 20.pdf>

D07.9.2. Membrane Single-ply

Applicable N/A

Number of base standards 1

Image Tool 250 x 188



Type: **Style 1**

Applies to: Group 1 Group 2 Group 3 Group 4 Other

Mfr: Carlisle Syntec Systems

Color: Off-white

Finish: Smooth

Model #: Single-ply, "flat" minimal slope

Other: Gabled or shed translucent panel clerestories

UFGS: Section 07 53 23 Ethylene-Propylene-Diene-Monomer Roofing
<http://www.wbdg.org/FFC/DOD/UFGS/UFGS 07 53 23.pdf>
Section 07 54 50 TPO Thermoplastic Single-Ply Roofing
(Not Available on UFGS)

D07.9.3. Built-up Multi-ply

Applicable N/A

D07.9.4. Concrete Tile

Applicable N/A

D07.9.5. Clay Tile

Applicable N/A

D07.9.6. Slate Shingles

Applicable N/A

D07.9.7. Vegetated System

Applicable N/A

D07.9.8. Ribbed Metal Sheeting

Applicable N/A Number of base standards 1

Image Tool 250 x 188

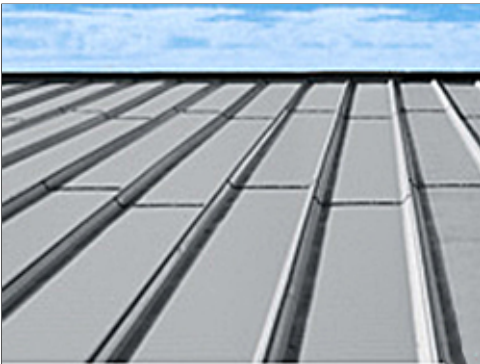

Type: **Style 1**

Applies to: Group 1 Group 2 Group 3 Group 4 Other

Mfr: Berridge

Color: Galvalume

Finish: Factory

Model #: High Seam Tee-Panel

Other: 24 gauge steel, Width: 16" Batten height: 1-3/4"

UFGS: Section 07 41 13.19 Batten-Seam Metal Roof Panels
(Not Available on UFGS)

D07.9.9. Composite Shingles

Applicable N/A

Number of base standards 1

Image Tool 250 x 188



Type: **Style 1**

Applies to: Group 1 Group 2 Group 3 Group 4 Other

Mfr: Tamko

Color: Earth Tones

Finish: Factory

Model #: Heritage

Other: Gabled or hipped with transverse gabled or hipped features

UFGS: Section 07 31 13 Glass-fiber-reinforced Asphalt Shingles
<http://www.wbdg.org/FFC/DOD/UFGS/UFGS 07 31 13.pdf>

D07.9.10. Other

Applicable N/A

D08. STRUCTURAL SYSTEMS

Comply with AF Corporate Standards for Facilities Exteriors:

<http://afcs.wbdg.org/facilities-exterior/index.html>

Comply with AF Corporate Standards for Structural Systems:

<http://afcs.wbdg.org/facilities-exterior/structural-systems/index.html>

Comply with AFCFS Recommended Materials:

<http://afcs.wbdg.org/facilities-exterior/structural-systems/materials/index.html>

Insert 3 photos for each facility group.

Image Tool 250 x 188

Group 1



Group 2



Group 3



Group 4



D08.1. Systems and Layouts

1. Pre-engineered structural steel framing may be used for Groups 1, 2 and 3 facilities; Installation-appropriate thermal envelopes, materials and detailing are required.
2. Select economical structural systems that integrate roof and wall systems.
3. Narrow buildings 60' or less in width with column-free interiors are preferred for office, administrative and personnel spaces; when interior columns are required optimize the structural grid layout for open-plan arrangements.
4. Fully coordinate structural grids with exterior window systems to align columns with window frames or wall systems.
5. When structure is exposed provide an organized appearance and coordinate with mechanical, electrical, plumbing, fire protection, information technology, and communications systems.
6. Limit the use of specialty systems (such as space frames, vaults or domes) and of structure as a visual feature.
7. Cost-effectively design interior bearing walls as thermal mass.
8. Manufacturers listed below are only provided to establish a baseline of equivalency among all applicable manufacturers.

D08.2. Structural Systems Materials

Note: Apply the below base-wide standards for Structural Systems (products, materials and color). Then refer to the Appendix and apply any additional requirements specifically related to the Facility District in which the project is located.

D08.2.1. Concrete

Applicable N/A

Number of base standards 1

Image Tool 250 x 188



Type: **Cast-In-Place**

Applies to: Group 1 Group 2 Group 3 Group 4 Other

Mfr: Custom

Color: Natural gray

Finish: Light texture

Model #: Post and beam and/or waffle slab

Other: Coordinate with mechanical for thermal heating technologies

UFGS: Section 03 30 53 Miscellaneous Cast-In-Place Concrete
<http://www.wbdg.org/FFC/DOD/UFGS/UFGS 03 30 53.pdf>
Section 03 33 00 Cast-In-Place Architectural Concrete
<http://www.wbdg.org/FFC/DOD/UFGS/UFGS 03 33 00.pdf>
Section 03 47 13 Tilt-Up Concrete
<http://www.wbdg.org/FFC/DOD/UFGS/UFGS 03 47 13.pdf>

D08.2.2. Insulated Concrete Forming (ICF)

Applicable N/A

Number of base standards 1

Image Tool 250 x 188



Type: **Modular ICF Block System**

Applies to: Group 1 Group 2 Group 3 Group 4 Other

Mfr: Greenblock

Color: Factory

Finish: Factory

Model #: Fixed-Web and / or GBLOX Panel System

Other: Provide engineered 6", 8", 10" and 12" core widths

UFGS: Section 03 30 53 Miscellaneous Cast-In-Place Concrete
<http://www.wbdg.org/FFC/DOD/UFGS/UFGS 03 30 53.pdf>
Section 03 11 19 Insulating Concrete Forming
(Not Available on UFGS)

D08.2.3. Steel

Applicable N/A

Number of base standards 1

Image Tool 250 x 188



Type: **Rigid Framing**

Applies to: Group 1 Group 2 Group 3 Group 4 Other

Mfr: US Steel

Color: Shop primed

Finish: Matte

Model #: Structural steel shapes

Other: N/A

UFGS: Section 05 12 00 Structural Steel
<http://www.wbdg.org/FFC/DOD/UFGS/UFGS 05 12 00.pdf>

D08.2.4. Pre-Engineered Steel

Applicable N/A

Number of base standards 1

Image Tool 250 x 188



Type: **Moment Frame**

Applies to: Group 1 Group 2 Group 3 Group 4 Other

Mfr: Behlen Building Systems

Color: Factory primed

Finish: Matte

Model #: Moment Frame

Other: Draped insulation may be used behind wall finish system;
Behlen standing seam roof system may be used for Group 3

UFGS: Section 13 12 00 Steel Building Systems
(Not Available on UFGS)

Section 13 34 19 Metal Building Systems

http://www.wbdg.org/FFC/DOD/UFGS/UFGS_13_34_19.pdf

D08.2.5. Masonry

Applicable N/A

Number of base standards 1

Image Tool 250 x 188

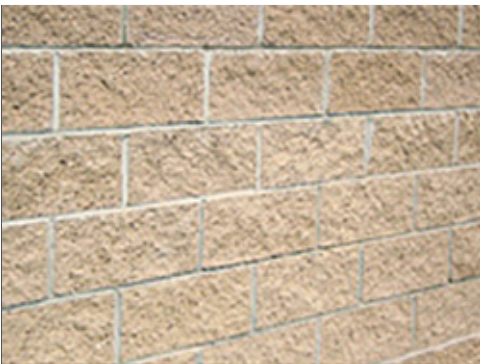

Type: **Load Bearing Wall Systems**

Applies to: Group 1 Group 2 Group 3 Group 4 Other

Mfr: Custom

Color: Light to medium beige

Finish: Per Exterior Wall Systems; Interiors use ground face

Model #: 8x8x16 nominal, face and corner units

Other: Coordinate interior walls with thermal heating systems

UFGS: Section 04 20 00 Unit Masonry

http://www.wbdg.org/FFC/DOD/UFGS/UFGS_04_20_00.pdf

D08.2.6. Heavy Timber

Applicable N/A

D08.2.7. Light-gauge Steel

Applicable N/A

Number of base standards 1

Image Tool 250 x 188



Type: **Steel Framing**

Applies to: Group 1 Group 2 Group 3 Group 4 Other

Mfr: Steelrite

Color: Factory

Finish: Galvanized

Model #: Structural framing shapes

Other: N/A

UFGS: Section 05 45 00 Light Gauge Steel Framing System
(Not Available on UFGS)

D08.2.8. Lumber Framing

Applicable N/A

Number of base standards 1

Image Tool 250 x 188



Type: **Style 1**

Applies to: Group 1 Group 2 Group 3 Group 4 Other

Mfr: Boise Cascade Wood Products

Color: N/A

Finish: S4S

Model #: Structural dimensional lumber

Other: N/A

UFGS: Section 06 10 00 Rough Carpentry
http://www.wbdg.org/FFC/DOD/UFGS/UFGS_06_10_00.pdf
Section 06 11 00 Wood Framing and Sheathing
(Not Available on UFGS)

D08.2.9. Other

Applicable N/A

D09.1. Passive and Active Systems

1. Fully integrate passive heating and cooling systems into facility designs whenever practical for the local climate prior to the design of active mechanical systems.
2. Provide optimized passive and active systems; design active mechanical systems to supplement thermal mass walls and floors.
3. Develop renewable energy systems including geo-exchange (ground source heat pumps) when life cycle cost effective.
4. Performance display screens, which report energy performance and utility savings, are encouraged; when provided locate these in building lobbies or common areas.
5. Solar domestic hot water systems are required when life cycle cost effective for the climate.
6. Integrate shading into building exteriors to reduce solar heat gain during hot seasons.

D09.2. Functionality and Efficiency

1. Fully coordinate mechanical, electrical, plumbing (MEP) and fire protection systems with each other and with the building structure, enclosure, thermal envelope and interior design.
2. Ensure direct exterior access is provided (for CE) to main mechanical and electrical rooms.
3. Screen exterior equipment from primary views (landscape, building masses, screen walls) and comply with ATEP requirements.
4. Keep equipment away from main building entrances; locate service area/yard on least visible side of a building.
5. Coordinate the location of all exterior meters, equipment and devices to provide convenient access and an overall coordinated and orderly appearance.
6. Design emergency generator systems integrally with all other building systems and avoid incompatible building additions; locate generators near service areas and ensure they are not visible from primary entrances.
7. When structure is exposed as a finished ceiling, fully integrate MEP and fire protection systems to provide an organized uncluttered appearance.
8. Conceal ducts, piping, conduits, devices, etc., when permanent walls, suspended ceilings or raised floors are provided; locate sprinkler heads in orderly configuration.
9. Limit interior wall-mounted equipment in occupied personnel spaces; avoid surface-mounted conduit and pipes.
10. Provide efficient utility rooms with layouts to facilitate system performance and maintenance; provide convenient access to controls, clearly label systems and include operating and maintenance instructions.
11. Separate mechanical and electrical and communications rooms.
12. Integrate recessed and wall-mounted fixtures such as fire standpipe cabinets and drinking fountains within permanent walls.

E01. Building Configurations

Comply with Air Force Corporate Standards for Building Configurations:

<http://afcfs.wbdg.org/facilities-interiors/buildings-configurations/index.html>

1. Provide open-plan configurations for office, administrative, operational and related activities and spaces for maximum flexibility. Use a “core and shell” approach in which all building systems, infrastructure and permanent interior partitions anticipate two or more uses (operations) during a facility's lifespan.
2. Create flexible interior configurations using Furniture, Fixtures & Equipment (FF&E) and limit private offices and private rooms. Refer to AFMAN 32-1084 for space requirements. To the greatest extent, limit permanent partitions to core areas such as toilet rooms, stairs, mechanical and utility rooms.
3. Use more durable long-lasting finishes in core areas for walls, ceilings, floor coverings and built-in casework. Coordinate interior FF&E layouts with structural grids during space planning.
4. Provide high-performance building configurations following UFC 1-200-02. Ensure passive design strategies are cost effectively incorporated before active mechanical systems are designed.
5. Comply with UFC 1-200-01, general building requirements. UFC 1-200-01 provides applicability of model building codes and government unique criteria for typical design disciplines and building systems, as well as for accessibility, antiterrorism, security, high performance and sustainability requirements, and safety.
6. Meet security and force protection requirements in UFC 4-010-01: DoD Minimum Antiterrorism Standards for Buildings.
7. Comply with AFCFS for supporting mission requirements, addressing human comfort and well being, and creating highly flexible interiors while satisfying metrics for high performance and sustainable buildings.
8. Provide a level of quality for interior features, materials and finishes that is appropriate for the Facility Group number. Group 1 may receive higher quality than Groups 2 thru 4. Refer to Facility Hierarchy.
9. Through open-plan configurations, preserve all passive and natural design strategies and fully integrate facility interiors with overall building systems.
10. Professional interior designers, or architects with significant interior design experience, must accomplish the design and review of applicable new construction, renovations and maintenance projects.
11. Consult with the State Historic Preservation Officer (SHPO) and base-level Historic Preservation offices regarding proposed changes to properties listed on or eligible for listing on the National Register of Historic Places. Follow requirements of The National Historic Preservation Act and Secretary of the Interior Standards for the Treatment of Historic Properties.
12. Maintain architectural compatibility following AFCFS and this Installation Facilities Standards (IFS) document to create continuity while avoiding monotony.

E01.1. Layout and Common Areas

Comply with Air Force Corporate Standards for Layout and Common Areas:

<http://afcfs.wbdg.org/facilities-interiors/buildings-configurations/layout-and-common-areas/index.html>

1. Create open-plan interior environments to accommodate changes.
2. Limit interior partitions, private offices and rooms; use furniture or modular systems to provide privacy and acoustic control.
3. When partitions are functionally justified such as for conference rooms, use systems furniture and moveable (demountable) floor-to-ceiling wall systems for acoustical or visual privacy.
4. Proportion lobbies and common spaces based on type of function, activity and facility group.

5. Allow no direct sight lines into restrooms.
6. Situate utility and core areas to minimize impact on daylighting and to maximize use as thermal buffers.
7. Ensure electrical, lighting and communications system can be adaptable to configuration changes.
8. Avoid power poles to the maximum extent; when poles are necessary minimize the number and coordinate locations with furniture placement and other elements.
9. Avoid sloping floors to maintain flexibility and eliminate future structural changes.
10. Special consideration may apply to Sensitive Compartmented Information Facilities (SCIFs).

E01.1.1. Interior Design Process

1. Comply with UFC 3-120-10 for the Comprehensive Interior Design (CID,) which includes both Structural Interior Design (SID) and Furniture, Fixtures & Equipment (FF&E) design services.
2. Use a collaborative, integrated planning and design team, composed of user, government support staff, and appropriate professionals. Integrate architectural features using simple detailing to create a professional appearance; avoid extravagant or excessive detailing.
3. Ensure interior designs satisfy the functional requirements within the context of flexibility, sustainability and the building's energy performance.
4. Base space planning on square foot allocations from AFM 32-1084. Identify special requirements if any, such as privacy separation, VIP areas, gathering spaces and storage. Note: The occupant's rank and position will influence the square footage and selection of materials.
5. Provide clear circulation and pathway finding for both horizontal and vertical directions that accommodate the number of personnel in the facility.
6. Maximize efficiencies in the space plan for functional relationships and adjacencies for all facility users. Efficiently create and situate rooms and support rooms such as conference / meeting rooms and break rooms.
7. Provide interior design building-related illustrations, drawings, schedules, materials selections, specifications and cost estimates as listed in UFC 3-120-10. Refer to Furnishings in this IFS also.
8. SID Format shall follow UFC 3-120-10.
9. Base the FF&E package on the furniture footprint developed in the SID. Identify all new or existing equipment needed and its users within each facility or each area of the facility. Provide specific information on: equipment sizes, electrical requirements, ventilation requirements, weight (if heavy), quantity, and security level if required. Presume all administrative spaces have computers and supporting equipment.

E01.1.2. Codes and Regulations

1. Refer to UFC 1-200-01 for modifications to the International Building Code (IBC) to determine applicable sections of the IBC. Both the IBC Chapter 3 and UFC 3-600-01 govern "Use and Occupancy Classification" for example.
2. Fire code requirements shall be as defined in the International Building Code (IBC) and must be used where dictated by UFC 1-200-01 DoD Building Code (General Building Requirements) except where noted in UFC 3-600-01 (Fire Protection Engineering For Facilities).
3. National Fire Protection Association (NFPA) 101 must be utilized to determine the occupancy classification as it relates to fire/smoke resistance rating of interior non-load bearing partitions (other than occupancy separation), means of egress, interior finish, features of fire protection (including vertical openings) and associated requirements.

E01.2. Quality and Comfort

Comply with Air Force Corporate Standards for Quality and Comfort:

<http://afcs.wbdg.org/facilities-interiors/buildings-configurations/quality-and-comfort/index.html>

1. Include durability in the life cycle cost analysis for best-value material selections with long life expectancies that do not show excessive wearing.
2. Select long-lasting materials and finishes for permanent core areas such as lobbies, restrooms and stairs.
3. Select low-maintenance materials and products that reduce ongoing servicing and repair and that are easy to clean.
4. Relate the visual quality of finishes to the Facility Group number.
5. Building and interior configurations should address both operations and climatic responses.
6. Convey a professional image; avoid trendy patterns and textures.
7. Use materials and finishes that provide a healthy indoor environment.
8. Orient interior spaces toward views while maintaining cost-effective building performance and efficiency.
9. Promote air movement and daylighting for human health and wellbeing.

E02. Floors

Comply with Air Force Corporate Standards for Floors:

<http://afcs.wbdg.org/facilities-interiors/floors/index.html>

E02.1. Floor Materials

Facility Group 1 floor materials shall be as follows.

Primary: Prepared Slabs (Ground, Polished)
Secondary: Porcelain tile
Tertiary: Carpet, Rubber Stair Treads

Facility Group 2 floor materials shall be as follows.

Primary: Prepared Slabs (Ground, Polished)
Secondary: Ceramic tile
Tertiary: Carpet, Rubber Stair Treads

Facility Group 3 floor materials shall be as follows.

Primary: Prepared Slabs (Ground)
Secondary: Prepared Slabs (Sealer)
Tertiary: N/A

Facility Group 4 floor materials shall be as follows.

Primary: Carpet
Secondary: Ceramic tile
Tertiary: N/A

1. Natural stone and terrazzo flooring may be used in high traffic areas of Group 1 as approved on a case basis.
2. Resilient and rapidly renewable flooring may be used in low traffic areas in Group 1, 2 and 4.
3. Manufacturers listed below are only provided to establish a baseline of equivalency among all applicable manufacturers.

Note: Apply the below base-wide standards for Floors (products, materials and color). Then refer to the Appendix and apply any additional requirements specifically related to the Facility District in which the project is located.

E02.1.1. Prepared Slabs

Applicable N/A

Number of base standards 2

Image Tool 250 x 188



Type: **Style 1, Ground and Polished**

Applies to: Group 1 Group 2 Group 3 Group 4 Other

Mfr: Local (TBD)

Color: Natural gray cement, light to dark beige aggregates

Finish: Fine polished texture

Model #: Medium to small aggregate

Other: N/A

UFGS: Section 03 35 45 Polished Concrete Finishing
(Not Available on UFGS)

Type:

Applies to: Group 1 Group 2 Group 3 Group 4 Other

Mfr: Local (TBD)

Color: Natural gray cement, light to dark beige aggregates

Finish: Medium polished texture, slip resistant

Model #: Medium to small aggregate

Other: N/A

UFGS: Section 03 35 45 Polished Concrete Finishing
(Not Available on UFGS)

E02.1.2. Natural Stone and Terrazzo

Applicable N/A

E02.1.3. Quarry Tile

Applicable N/A

Number of base standards 1

Image Tool 250 x 188



Type: **Style 1**

Applies to: Group 1 Group 2 Group 3 Group 4 Other

Mfr: Daltille

Color: Earth tones

Finish: Matte, slip resistant

Model #: N/A

Other: Use in commercial kitchen flooring.

UFGS: Section 09 30 10 Ceramic, Quarry, and Glass Tiling
<http://www.wbdg.org/FFC/DOD/UFGS/UFGS 09 30 10.pdf>

E02.1.4. Ceramic Tile

Applicable N/A

Number of base standards 2

Image Tool 250 x 188



Type: **Style 1 Porcelain**

Applies to: Group 1 Group 2 Group 3 Group 4 Other

Mfr: Daltille

Color: Earth tones

Finish: Matte, slip resistant

Model #: Porcelain tile

Other: Use in high traffic areas. Epoxy grout is recommended.

UFGS: Section 09 30 10 Ceramic, Quarry, and Glass Tiling
<http://www.wbdg.org/FFC/DOD/UFGS/UFGS 09 30 10.pdf>

Type: **Style 2 Ceramic**



Applies to: Group 1 Group 2 Group 3 Group 4 Other

Mfr: Daltile

Color: Earth tones

Finish: Matte, slip resistant

Model #: Ceramic tile

Other: Use in low traffic area toilet rooms.

UFGS: Section 09 30 10 Ceramic, Quarry, and Glass Tiling
<http://www.wbdg.org/FFC/DOD/UFGS/UFGS 09 30 10.pdf>

E02.1.5. Resilient Floor

Applicable N/A

Number of base standards 1

Image Tool 250 x 188



Type: **Style 1 Stair Treads**

Applies to: Group 1 Group 2 Group 3 Group 4 Other

Mfr: Roppe

Color: Neutral tones

Finish: Factory

Model #: Raised design rubber tread

Other: Stair treads material

UFGS: Section 09 65 00 Resilient Flooring
<http://www.wbdg.org/FFC/DOD/UFGS/UFGS 09 65 00.pdf>

E02.1.6. Carpet

Applicable N/A

Number of base standards 2

Image Tool 250 x 188



Type: **Style 1**

Applies to: Group 1 Group 2 Group 3 Group 4 Other

Mfr: Mohawk Group

Color: Neutral multi-colored tones/patterned/solid

Finish: Yarn: Nylon 6 or 6.6/cut pile or loop pile

Model #: Broadloom, 6' wide rolled, carpet tiles, entry walk-off carpet

Other: N/A

UFGS: UFGS 09 68 00 Carpeting

<http://www.wbdg.org/FFC/DOD/UFGS/UFGS 09 68 00.pdf>

Type: **Style 2**

Applies to: Group 1 Group 2 Group 3 Group 4 Other

Mfr: Mohawk Group

Color: Earth tones

Finish: Factory

Model #: Broadloom, residential loop, "Smartstrand"

Other: N/A

UFGS: UFGS 09 68 00 Carpeting

<http://www.wbdg.org/FFC/DOD/UFGS/UFGS 09 68 00.pdf>

E02.1.7. Rapidly-Renewable Products

Applicable N/A

E02.1.8. Other

Applicable N/A

E03. Walls

Comply with Air Force Corporate Standards for Walls:
<http://afcs.wbdg.org/facilities-interiors/walls/index.html>

E03.1. Wall Materials

Facility Group 1 wall materials shall be as follows.

Primary: Brick (or other as approved by the BCE)
Secondary: Gypsum board (painted)
Tertiary: Ceramic tile (restrooms)

Facility Group 2 wall materials shall be as follows.

Primary: Brick
Secondary: Gypsum board (painted)
Tertiary: Ceramic tile (restrooms)

Facility Group 3 wall materials shall be as follows.

Primary: Ground face block, sealed (do not paint)
Secondary: N/A
Tertiary: Ceramic tile (restrooms)

Facility Group 4 wall materials shall be as follows.

Primary: Gypsum board (painted)
Secondary: N/A
Tertiary: Ceramic tile (restrooms)

1. Follow UFC 3-450-01 (Vibration and Noise Control) for acoustic design issues including speech privacy, sound isolation or sound masking.
2. Select and apply paint with sheens (gloss levels) appropriate for the application following UFGS Section 09 90 00 Paints and Coatings.
3. Provide ceramic tile on wet walls of kitchens, toilet rooms, locker rooms, etc., in all facility groups.
4. Neutral split-face or ground-face integrally colored block with a clear sealer may be used in Group 3. Do not paint block.
5. Provide rubber base on drywall partitions in Groups 1 and 2.
6. Hardwood base may only be used in Group 1 as approved on a case basis.
7. Hardwood chair rails / bumper rails may be used in high-use areas of Groups 1 and 2; aqueous clear finishes are preferred to reduce maintenance; plastic chair rails are permitted only in medical applications.
8. Decorative moldings may be used only in Group 1 when approved on a case basis.
9. Corner guards are permitted only in high traffic spaces with wheeled or cart use such as private service areas in Groups 1 and 2; stainless steel corners guards with a brushed finish may be judiciously used in Group 3.
10. Group 4 may use painted composite wood base.
11. Manufacturers listed below are only provided to establish a baseline of equivalency among all applicable manufacturers.

Note: Apply the below base-wide standards for Walls (products, materials and color). Then refer to the Appendix and apply any additional requirements specifically related to the Facility District in which the project is located.

E03.1.1. Concrete

Applicable N/A

E03.1.2. Masonry

Applicable N/A

Number of base standards 1

Image Tool 250 x 188



Type: **Modular Face Brick**

Applies to: Group 1 Group 2 Group 3 Group 4 Other

Mfr: Local (TBD)

Color: Red blend

Finish: Light texture

Model #: Coursed unit masonry

Other: Brick is preferred. Concrete block may only be used in Group 3 when approved by the BCE.

UFGS: Section 03 33 00 Cast-In-Place Architectural Concrete
<http://www.wbdg.org/FFC/DOD/UFGS/UFGS 03 33 00.pdf>

E03.1.3. Ceramic Tile

Applicable N/A

Number of base standards 1

Image Tool 250 x 188

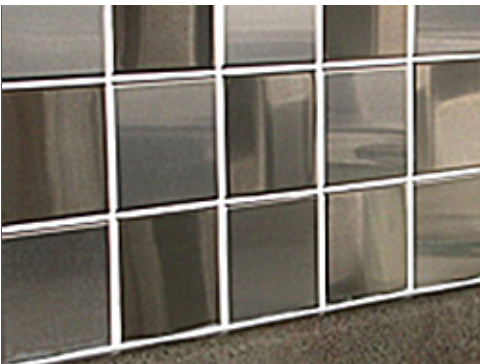

Type: **Style 1**

Applies to: Group 1 Group 2 Group 3 Group 4 Other

Mfr: Daltile

Color: Earth tones

Finish: Gloss, Semi-gloss

Model #: Ceramic wall tile

Other: Located on wet walls in restrooms

UFGS: Section 09 30 10 Ceramic, Quarry, and Glass Tiling
<http://www.wbdg.org/FFC/DOD/UFGS/UFGS 09 30 10.pdf>

E03.1.4. Gypsum Board

Applicable N/A

Number of base standards 1

Image Tool 250 x 188



Type: **Style 1**

Applies to: Group 1 Group 2 Group 3 Group 4 Other

Mfr: US Gypsum

Color: Solid Earth tone colors

Finish: Paint (Sheen per UFGS)

Model #: Tapered edge

Other: N/A

UFGS: Section 09 29 00 Gypsum Board
<http://www.wbdg.org/FFC/DOD/UFGS/UFGS 09 29 00.pdf>
Section 09 90 00 Paints and Coatings
<http://www.wbdg.org/FFC/DOD/UFGS/UFGS 09 90 00.pdf>

E03.1.5. Metal Panels

Applicable N/A

E03.1.6. Wood Paneling

Applicable N/A

E03.1.7. Rapidly-Renewable Products

Applicable N/A

E03.1.8. Other

Applicable N/A

E04. Ceilings

Comply with Air Force Corporate Standards for Ceilings:
<http://afcs.wbdg.org/facilities-interiors/ceilings/index.html>

E04.1. Ceiling Materials

Facility Group 1 ceiling materials shall be as follows.

Primary: Exposed Framing (Roof / Floor Structure Above)

Secondary: Grid and Acoustical Tile

Tertiary:

Facility Group 2 ceiling materials shall be as follows.

Primary: Exposed Framing (Roof / Floor Structure Above)

Secondary: Grid and Acoustical Tile

Tertiary: Gypsum board (painted)

Facility Group 3 ceiling materials shall be as follows.

Primary: Exposed Framing (Roof / Floor Structure Above)

Secondary: Exposed Framing (Roof / Floor Structure Above)

Tertiary: Gypsum board (painted)

Facility Group 4 ceiling materials shall be as follows.

Primary: Gypsum board (painted)

Secondary: N/A

Tertiary: N/A

1. Accent ceiling materials such as metal, wood, and rapidly renewable may be used in Group 1 as approved on a case basis.
2. Follow UFC 3-450-01 (Vibration and Noise Control) for acoustic design issues including speech privacy, sound isolation or sound masking.
3. Manufacturers listed below are only provided to establish a baseline of equivalency among all applicable manufacturers.

Note: Apply the below *base-wide standards* for Ceilings (products, materials and color). Then refer to the Appendix and apply any additional requirements specifically related to the Facility District in which the project is located.

E04.1.1. Exposed Framing (Roof / Floor Structure Above)

Applicable N/A

Number of base standards 1

Image Tool 250 x 188



Type: **Style 1**

Applies to: Group 1 Group 2 Group 3 Group 4 Other

Mfr: Vulcraft

Color: Neutral colors reviewed on a case basis

Finish: Field painted (Sheen per UFGS)

Model #: Formlok floor and roof decking

Other: N/A

UFGS: Section 05 30 00 Steel Decks
http://www.wbdg.org/FFC/DOD/UFGS/UFGS_05_30_00.pdf

E04.1.2. Exposed Concrete

Applicable N/A

E04.1.3. Grid and Acoustical Tile

Applicable N/A Number of base standards 1

Image Tool 250 x 188



Type: **Style 1**

Applies to: Group 1 Group 2 Group 3 Group 4 Other

Mfr: Armstrong

Color: White

Finish: Factory

Model #: 2'x2' Tegular with reveal edge and fine texture, grid 15/16"

Other: Performance characteristics are Class A; NRC-0.70; CAC-40; LR-0.86; minimum recycled content 82%.

UFGS: Section 09 51 00 Acoustical Ceilings
<http://www.wbdg.org/FFC/DOD/UFGS/UFGS 09 51 00.pdf>

E04.1.4. Gypsum Board

Applicable N/A Number of base standards 1

Image Tool 250 x 188



Type: **Style 1**

Applies to: Group 1 Group 2 Group 3 Group 4 Other

Mfr: US Gypsum

Color: Solid neutral colors

Finish: Paint (sheen per UFGS)

Model #: Tapered edge

Other: N/A

UFGS: Section 09 29 00 Gypsum Board
<http://www.wbdg.org/FFC/DOD/UFGS/UFGS 09 29 00.pdf>
Section 09 90 00 Paints and Coatings
<http://www.wbdg.org/FFC/DOD/UFGS/UFGS 09 90 00.pdf>

E04.1.5. Metal Panels

Applicable N/A

E04.1.6. Wood

Applicable N/A

E04.1.7. Rapidly-Renewable Products

Applicable N/A

E04.1.8. Other

Applicable N/A

E05. Doors and Windows

Comply with Air Force Corporate Standards for Doors and Windows:

<http://afcs.wbdg.org/facilities-interiors/doors-and-windows/index.html>

E05.1. Doors and Windows and Frames Materials

Facility Group 1

door (frame) and window frame materials shall be as follows.

Primary: Aluminum, clear anodized

Secondary: Hollow metal (painted)

Tertiary: N/A

Facility Group 1

door (leaf) materials shall be as follows.

Primary: Hardwood veneer

Secondary: Hollow metal (painted)

Tertiary: N/A

Facility Group 2

door (frame) and window frame materials shall be as follows.

Primary: Aluminum, clear anodized

Secondary: Hollow metal (painted)

Tertiary: N/A

Facility Group 2

door (leaf) materials shall be as follows.

Primary: Hardwood veneer

Secondary: Hollow metal (painted)

Tertiary: N/A

Facility Group 3

door (frame) and window frame materials shall be as follows.

Primary: Hollow metal (galvanized, painted)

Secondary: Hollow metal (galvanized, painted)

Tertiary: N/A

Facility Group 3

door (leaf) materials shall be as follows.

Primary: Hollow metal (galvanized, painted)

Secondary: Hollow metal (galvanized, painted)

Tertiary: N/A

Facility Group 4

door (frame) and window frame materials shall be as follows.

Primary: Wood

Secondary: N/A

Tertiary: N/A

Facility Group 4

door (leaf) materials shall be as follows.

Primary: Wood solid core

Secondary: Composite solid core

Tertiary: N/A

1. Hardwood casings may be provided over metal frames in Group 1 as approved on a case basis.
2. Paneled textured doors are preferred in Group 4.
3. Do not use hollow-core wood doors.
4. Generally match original hardware in renovations.
5. Manufacturers listed below are only provided to establish a baseline of equivalency among all applicable manufacturers.

Note: Apply the below *base-wide standards* for Doors and Windows (products, materials and color). Then refer to the Appendix and apply any additional requirements specifically related to the Facility District in which the project is located.

E05.1.1. Aluminum

Applicable N/A

Number of base standards 1

Image Tool 250 x 188



Type: **Style 1**

Applies to: Group 1 Group 2 Group 3 Group 4 Other

Mfr: Kawneer

Color: Clear anodized

Finish: Factory

Model #: InFrame Interior Framing, (2x4 nominal framing)

Other: Satin stainless steel hardware

UGFS: Section 08 41 13 Aluminum-Framed Entrances and Storefronts
<http://www.wbdg.org/FFC/DOD/UGFS/UGFS 08 41 13.pdf>
Section 08 71 00 Door Hardware
<https://www.wbdg.org/FFC/DOD/UGFS/UGFS 08 71 00.pdf>

E05.1.2. Hollow Metal

Applicable N/A

Number of base standards 2

Image Tool 250 x 188



Type: **Steel Doors**

Applies to: Group 1 Group 2 Group 3 Group 4 Other

Mfr: Steelcraft

Color: Neutral colors

Finish: Paint (Sheen per UFGS)

Model #: Hollow metal, 2" w. frames, 16 gauge (welded corners) grouted solid

Other: Provide in Group 3 and in utility areas of Group 1 and 2. Provide A25 "galvannealed" coating. All interior steel doors shall have a factory applied primer finish. Provide satin stainless steel hardware.

UGFS: Section 08 11 13 Steel Doors and Frames
<http://www.wbdg.org/FFC/DOD/UGFS/UGFS 08 11 13.pdf>
Section 08 71 00 Door Hardware
<https://www.wbdg.org/FFC/DOD/UGFS/UGFS 08 71 00.pdf>

Type: **Steel Frames**

Applies to: Group 1 Group 2 Group 3 Group 4 Other

Mfr: Steelcraft

Color: Neutral colors

Finish: Paint (Sheen per UFGS)

Model #: Hollow metal, frame grouted solid

Other: Satin stainless steel hardware

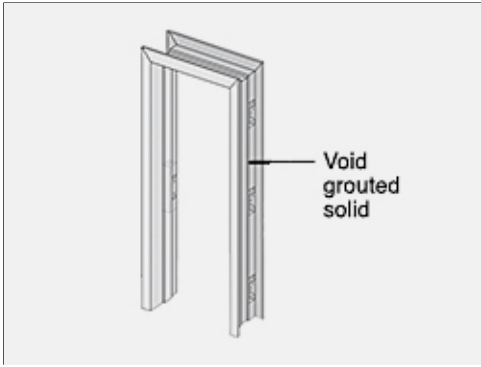

UFGS: Section 08 11 13 Steel Doors and Frames
<http://www.wbdg.org/FFC/DOD/UFGS/UFGS 08 11 13.pdf>
Section 08 71 00 Door Hardware
<https://www.wbdg.org/FFC/DOD/UFGS/UFGS 08 71 00.pdf>

E05.1.3. Wood

Applicable N/A

Number of base standards 2

Image Tool 250 x 188

Type: **Style 1, Administrative**

Applies to: Group 1 Group 2 Group 3 Group 4 Other

Mfr: Simpson

Color: Natural hardwood veneer

Finish: Clear Sealer, satin (aqueous)

Model #: 3'x7'x 1 3/4", solid core

Other: Satin stainless steel hardware, Glass lites may be used. Stained birch veneer face, 5 ply construction, rotary cut finish.



UFGS: Section 08 14 00 Wood Doors
<http://www.wbdg.org/FFC/DOD/UFGS/UFGS 08 14 00.pdf>
Section 08 71 00 Door Hardware
<https://www.wbdg.org/FFC/DOD/UFGS/UFGS 08 71 00.pdf>

Type: **Style 2, Residential**



Applies to: Group 1 Group 2 Group 3 Group 4 Other

Mfr: Simpson

Color: Natural hardwood veneer or paint grade

Finish: Clear Sealer or paint, satin (aqueous)

Model #: Full slab or panels

Other: Satin nickel hardware

UGFS: Section 08 14 00 Wood Doors
<http://www.wbdg.org/FFC/DOD/UGFS/UGFS 08 14 00.pdf>
Section 08 71 00 Door Hardware
<https://www.wbdg.org/FFC/DOD/UGFS/UGFS 08 71 00.pdf>

E05.1.4. Other

Applicable N/A

E06. Casework Systems

Comply with Air Force Corporate Standards for Casework Systems:

<http://afcfs.wbdg.org/facilities-interiors/casework-systems/index.html>

E06.1. Casework Materials

1. Select casework systems and materials considering durability, maintenance requirements and LCCA.
2. Natural stone and cast stone countertops may only be used in Group 1 with approval on a case basis.
3. Metal cabinets and countertops shall be provided in heavy-use operations and in Group 3.
4. Refer to AFCFS for approved materials.
5. Manufacturers listed below are only provided to establish a baseline of equivalency among all applicable manufacturers.

E06.1.1. Plastic Laminate

Applicable N/A

Number of base standards 1

Image Tool 250 x 188



Type: **Style 1, Low Use Areas**

Applies to: Group 1 Group 2 Group 3 Group 4 Other

Mfr: Formica

Color: Medium Earth tones and neutral tones

Finish: Light textured

Model #: High pressure laminate

Other: Combine with matching solid-surface banding on casework edges.

UFGS: Section 06 41 16.00 10 Plastic-Laminate-Clad Architectural Cabinets
http://www.wbdg.org/FFC/DOD/UFGS/UFGS_06_41_16.00_10.pdf

E06.1.2. Solid Polymer Surface

Applicable N/A

Number of base standards 1

Image Tool 250 x 188



Type: **Style 1, High Use Areas**

Applies to: Group 1 Group 2 Group 3 Group 4 Other

Mfr: Corian

Color: Medium Earth tones and neutral tones

Finish: Light textured

Model #: Solid Surface

Other: Faces and edge banding

UFGS: Section 12 36 00 Countertops
http://www.wbdg.org/FFC/DOD/UFGS/UFGS_12_36_00.pdf

E06.1.3. Rapidly-Renewable Products

Applicable N/A

Number of base standards 1

Image Tool 250 x 188



Type: **Style 1 Moderate Use Areas**

Applies to: Group 1 Group 2 Group 3 Group 4 Other

Mfr: Plyboo

Color: Natural or amber

Finish: Satin

Model #: Flat grain bamboo plywood

Other: FSC® Certified 100%.

UFGS: Section 12 32 00 Manufactured Wood Casework
<http://www.wbdg.org/FFC/DOD/UFGS/UFGS 12 32 00.pdf>

E06.1.4. Metal

Applicable N/A

Number of base standards 1

Image Tool 250 x 188



Type: **Style 1**

Applies to: Group 1 Group 2 Group 3 Group 4 Other

Mfr: Steel Sentry

Color: Natural stainless steel or neural colors (steel)

Finish: Mill (stainless) or Powder coated (steel)

Model #: Lab, workbench, computer workstation

Other: Provide highly durable fabrications and finishes in Group 3 which are subjected to heavy use.

UFGS: Section 12 31 00 Manufactured Metal Casework
<http://www.wbdg.org/FFC/DOD/UFGS/UFGS 12 31 00.pdf>

E06.1.5. Other

Applicable N/A

E06.2. Countertop Materials

E06.2.1. Plastic Laminate

Applicable N/A Number of base standards 1

Image Tool 250 x 188



Type: **Style 1, Low Use Areas**

Applies to: Group 1 Group 2 Group 3 Group 4 Other

Mfr: Formica

Color: Medium Earth tones and neutral tones

Finish: Light textured

Model #: High pressure laminate

Other: Only use rounded half or full bullnose and integral backsplash. Do not use plastic laminate edge banding on front edges.

UFGS: Section 06 41 16.00 10 Plastic-Laminate-Clad Architectural Cabinets
http://www.wbdg.org/FFC/DOD/UFGS/UFGS_06_41_16.00_10.pdf

E06.2.2. Solid Polymer Surface

Applicable N/A Number of base standards 1

Image Tool 250 x 188



Type: **Style 1, High Use Areas**

Applies to: Group 1 Group 2 Group 3 Group 4 Other

Mfr: Corian

Color: Medium Earth tones and neutral tones

Finish: Light textured

Model #: Solid Surface

Other: Faces and edges

UFGS: Section 12 36 00 Countertops
http://www.wbdg.org/FFC/DOD/UFGS/UFGS_12_36_00.pdf

E06.2.3. Natural Stone

Applicable N/A

Number of base standards 1

Image Tool 250 x 188



Type: **Style 1, Group 1 High Visibility, Heavy Use**

Applies to: Group 1 Group 2 Group 3 Group 4 Other

Mfr: Local (TBD)

Color: Neutral tones

Finish: High polish, sealer

Model #: Custom cut slabs

Other: N/A

UFGS: Section 12 36 00 Countertops

[http://www.wbdg.org/FFC/DOD/UFGS/UFGS 12 36 00.pdf](http://www.wbdg.org/FFC/DOD/UFGS/UFGS_12_36_00.pdf)

E06.2.4. Cast Stone

Applicable N/A

Number of base standards 1

Image Tool 250 x 188

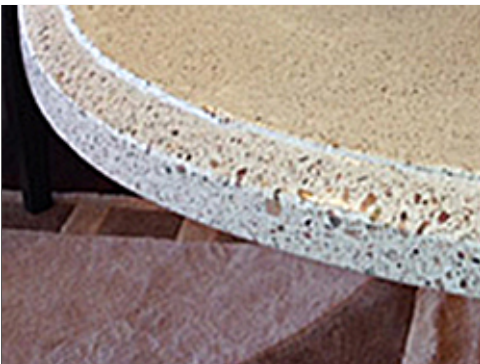

Type: **Style 1, Group 1 High Visibility, Heavy Use**

Applies to: Group 1 Group 2 Group 3 Group 4 Other

Mfr: Local (TBD)

Color: Neutral tones

Finish: High polish, sealer

Model #: Custom cast or cut slabs

Other: N/A

UFGS: Section 12 36 00 Countertops

[http://www.wbdg.org/FFC/DOD/UFGS/UFGS 12 36 00.pdf](http://www.wbdg.org/FFC/DOD/UFGS/UFGS_12_36_00.pdf)

E06.2.5. Metal

Applicable N/A

Number of base standards 1

Image Tool 250 x 188



Type: _____

Applies to: Group 1 Group 2 Group 3 Group 4 Other

Mfr: Local (TBD)

Color: Natural stainless steel

Finish: Mill

Model #: Custom fabricated countertops

Other: Provide integral fronts, sides and backsplash

UFGS: Section 12 31 00 Manufactured Metal Casework
<http://www.wbdg.org/FFC/DOD/UFGS/UFGS 12 31 00.pdf>

E06.2.6. Other

Applicable N/A

E07. Furnishings

Comply with Air Force Corporate Standards for Furnishings:
<http://afcs.wbdg.org/facilities-interiors/furnishings/index.html>

E07.1. Durability and Serviceability

Comply with AF Corporate Standards for Durability and Serviceability:
<http://afcs.wbdg.org/facilities-interiors/furnishings/durability-and-serviceability/index.html>

E07.2. Accessories

Comply with AF Corporate Standards for Accessories:
<http://afcs.wbdg.org/facilities-interiors/furnishings/accessories/index.html>

E08. Interior Signs

Comply with Air Force Corporate Standards for Interior Signs:
<http://afcs.wbdg.org/facilities-interiors/interior-signs/index.html>

E08.1 Types and Color

Comply with Air Force Corporate Standards for Types and Color:
<http://afcfs.wbdg.org/facilities-interiors/interior-signs/types-and-color/index.html>

E08.2. Interior Signs Materials

1. Natural stone, masonry and cast stone signs may only be used in Group 1 with approval on a case basis.

E09. Lighting, Power and Communication

<http://afcfs.wbdg.org/facilities-interiors/lighting-power-and-communication/index.html>

E09.1. Functionality and Efficiency

Comply with Air Force Corporate Standards for Functionality and Efficiency:
<http://afcfs.wbdg.org/facilities-interiors/lighting-power-and-communication/functionality-and-efficiency/index.html>

E09.2. Types and Color

F. APPENDIX - Facility Districts

- Applicable
- N/A

G. APPENDIX - References

Comply with Air Force Corporate Standards:
<http://afcfs.wbdg.org/index.html>