

---

**(PRE-FINAL)**  
**YOUNGSTOWN AIR RESERVE STATION**  
**INSTALLATION FACILITIES STANDARDS (IFS)**



Installation Elements



Site Development



Facilities Exteriors



Facilities Interiors

**APPROVED FOR PUBLIC RELEASE; DISTRIBUTION UNLIMITED**

Signature Field

**Youngstown Air Reserve Station IFS**

**Table of Contents**

<b>A. OVERVIEW</b> .....	5	B03.2.3. Preserves	
A01. Facility Hierarchy .....	6	B03.2.4. Perimeter Fence	
A02. Facility Quality .....	6	<b>C. SITE DEVELOPMENT</b> .....	31
A03. Facility Districts .....	6	C01. Site Design .....	31
<b>B. INSTALLATION ELEMENTS</b> .....	8	C01.1. Site Design Considerations .....	31
B01. Comprehensive Planning .....	8	C01.2. Building Orientation .....	32
B01.1. Installation Development Plan (IDP) .....	8	C02. Utilities .....	33
B01.1.1. IFS Component Plan of IDP		C02.1. Utility Components.....	33
B01.1.2. Brief History of Base		C03. Parking Areas .....	34
B01.1.3. Future Development		C03.1. Configurations and Design .....	34
B02. Street Envelope Standards .....	10	C03.1.1. Paving and Striping	
B02.1. Hierarchy of Streets .....	11	C03.1.2. Curbing	
B02.1.1. Arterial Streets		C03.1.3. Internal Islands and Medians	
B02.1.2. Collector Streets		C03.2. Parking Structures .....	37
B02.1.3. Local Streets		C03.3. Connectivity .....	37
B02.1.4. Special Routes		C04. Stormwater Management .....	38
B02.2. Hierarchy of Intersections .....	15	C04.1. Stormwater Requirements .....	38
B02.2.1. Arterials		C05. Sidewalks, Bikeways and Trails .....	39
B02.2.2. Arterial/Collector		C05.1. Circulation and Paving .....	39
B02.2.3. Collectors		C05.1.1. Ramps and Stairs	
B02.2.4. Special Intersections		C05.1.2. Lighting	
B02.2.5. Street Frontage Requirements		C06. Landscape .....	42
B02.2.6. Sight Lines		C06.1. Climate-based Materials .....	42
B02.3. Street Elements .....	20	C06.1.1. Landscape Design Concept	
B02.3.1. Paving		C06.1.2. Xeriscape Design Principles	
B02.3.2. Curb and Gutter		C06.1.3. Minimizing Water Requirements	
B02.3.3. Utility Service Elements		C06.1.4. Plant Material Selection	
B02.3.4. Traffic Signs		C06.1.5. Water Budgeting (Hydrozones)	
B02.3.5. Street Lighting		C06.1.6. Base Entrance Landscaping	
B02.3.6. Other		C06.1.7. Streetscape Landscaping	
B03. Open Space / Public Space .....	23	C06.1.8. Pedestrian Circulation Landscaping	
B03.1. Plazas, Monuments and Static Displays .....	24	C06.1.9. Parking Lot Landscaping	
B03.1.1. Paved Plazas		C06.1.10. Screen/Accent Landscaping	
B03.1.2. Sculptures, Markers and Statuary		C06.1.11. Other	
B03.1.3. Static Display of Aircraft		C07. Site Furnishings .....	50
B03.2. Grounds and Perimeters .....	27	C07.1. Furnishings and Elements .....	50
B03.2.1. Parade Grounds			
B03.2.2. Parks			



Table of contents continued

C07.2. Site Furnishings Products, Materials / Color ..	52	D03.3.4. Thermal Shading	
C07.2.1. Barbeque Grills		D03.3.5. Renewable Heating/Cooling	
C07.2.2. Benches		D03.3.6. Solar Photovoltaic System	
C07.2.3. Bike Racks		D03.3.7. Solar Thermal System	
C07.2.4. Bike Lockers		D04. Building Entrances .....	90
C07.2.5. Bollards		D04.1. Primary Entrances .....	91
C07.2.6. Bus Shelters		D04.2. Secondary Entrances .....	91
C07.2.7. Drinking Fountains		D05. Wall Systems .....	92
C07.2.8. Dumpster Enclosures / Gates		D05.1. Hierarchy of Materials .....	93
C07.2.9. Fencing		D05.2. Layout, Organization and Durability .....	93
C07.2.10. Flagpoles		D05.3. Equipment, Vents and Devices .....	94
C07.2.11. Lighting – Landscape / Accent		D05.4 Wall Systems Materials .....	94
C07.2.12. Litter and Ash Receptacles		D05.4.1. Flat Metal Panels	
C07.2.13. Picnic Tables		D05.4.2. Brick Veneer	
C07.2.14. Planters – Free Standing		D05.4.3. Architectural Precast	
C07.2.15. Play Equipment		D05.4.4. Stucco Over Sheathing	
C07.2.16. Screen Walls		D05.4.5. Curtain Wall	
C07.2.17. Tree Grates		D05.4.6. Cast-in Place Concrete	
C07.2.18. Other		D05.4.7. Tilt-up Concrete	
C08. Exterior Signs .....	66	D05.4.8. Ribbed Metal Sheeting	
C08.1. Colors and Types .....	66	D05.4.9. EIFS	
C08.1.1. Materials and Color Specifications		D05.4.10.GFRC	
C08.1.2. Installation and Gate Identification Signs		D05.4.11.Concrete Block	
C08.1.3. Building Identification Signs		D05.4.12. Fiber Cement Siding	
C08.1.4. Traffic Control Devices (Street Signs)		D05.4.13. Other	
C08.1.5. Directional and Wayfinding Signs		D06. Doors and Windows .....	101
C08.1.6. Informational Signs		D06.1. Types .....	102
C08.1.7. Motivational Signs		D06.2. Layout and Geometry .....	102
C08.1.8. Parking Lot Signs		D06.3. Glazing and Shading .....	102
C08.1.9. Regulatory Signs		D06.4. Hardware .....	102
C08.1.10. Other		D06.5. Doors and Windows Materials .....	103
C09. Lighting .....	75	D06.5.1. Anodized Aluminum	
C09.1. Fixtures and Lamping .....	75	D06.5.2. Hollow Metal	
C09.2. Light Fixture Types .....	76	D06.5.3. Aluminum-clad Wood	
C09.2.1. Street Lighting		D06.5.4. Other	
C09.2.2. Parking Lot Lighting		D07. Roof Systems .....	105
C09.2.3. Lighted Bollards		D07.1. Roof Type and Form .....	106
C09.2.4. Sidewalk Lighting		D07.2. Roof Slope .....	106
C09.2.5. Walls / Stairs Lighting		D07.3. Parapets and Copings .....	106
C09.2.6. Other		D07.4. Color and Reflectivity .....	107
<b>D. FACILITIES EXTERIORS .....</b>	<b>80</b>	D07.5. Gutters, Downspouts, Scuppers, Drains .....	107
D01. Supporting the Mission .....	80	D07.6. Roof Vents and Elements .....	107
D02. Sustainability .....	80	D07.7. Clerestories and Skylights .....	108
D03. Architectural Features .....	81	D07.8. Vegetated Roof .....	108
D03.1. Orientation, Massing and Scale .....	82		
D03.2. Architectural Character .....	83		
D03.3. Details and Color .....	84		
D03.3.1. Climate-based Data			
D03.3.2. Natural Ventilation System			
D03.3.3. Thermal Mass			

Table of contents continued

D07.9. Roof Systems Materials .....	108	E04. Ceilings .....	127
D07.9.1. Standing Seam Metal		E04.1. Ceiling Materials .....	127
D07.9.2. Membrane Single-ply		E04.1.1. Exposed Framing (Roof / Floor Structure	
D07.9.3. Built-up Multi-ply		Above)	
D07.9.4. Concrete Tile		E04.1.2. Exposed Concrete	
D07.9.5. Clay Tile		E04.1.3. Grid and Acoustical Tile	
D07.9.6. Slate Shingles		E04.1.4. Gypsum Board	
D07.9.7. Vegetated System		E04.1.5. Metal Panels	
D07.9.8. Ribbed Metal Sheeting		E04.1.6. Wood	
D07.9.9. Composite Shingles		E04.1.7. Rapidly-Renewable Products	
D07.9.10. Other		E04.1.8. Other	
D08. Structural Systems .....	111	E05. Doors and Windows .....	130
D08.1. Systems and Layouts .....	112	E05.1. Doors and Windows and Frames Materials ....	130
D08.2. Structural Systems Materials .....	112	E05.1.1. Aluminum	
D08.2.1. Concrete		E05.1.2. Hollow Metal	
D08.2.2. Insulated Concrete Forming (ICF)		E05.1.3. Wood	
D08.2.3. Steel		E05.1.4. Other	
D08.2.4. Pre-Engineered Steel		E06. Casework Systems .....	134
D08.2.5. Masonry		E06.1. Casework Materials .....	134
D08.2.6. Heavy Timber		E06.1.1. Plastic Laminate	
D08.2.7. Light-gauge Steel		E06.1.2. Solid Polymer Surface	
D08.2.8. Lumber Framing		E06.1.3. Rapidly-Renewable Products	
D08.2.9. Other		E06.1.4. Metal	
D09. Mechanical, Electrical and Plumbing .....	115	E06.1.5 Other	
D09.1. Passive and Active Systems .....	116	E06.2. Countertop Materials .....	137
D09.2. Functionality and Efficiency .....	116	E06.2.1. Plastic Laminate	
<b>E. FACILITIES INTERIORS .....</b>	<b>117</b>	E06.2.2. Solid Polymer Surface	
E01. Building Configurations .....	118	E06.2.3. Natural Stone	
E01.1. Layout and Common Areas .....	118	E06.2.4. Cast Stone	
E01.1.1. Interior Design Process		E06.2.5. Metal	
E01.1.2. Codes and Regulations		E06.2.6 Other	
E01.2. Quality and Comfort .....	120	E07. Furnishings .....	139
E02. Floors .....	120	E07.1. Durability and Serviceability .....	139
E02.1. Floor Materials .....	120	E07.2. Accessories .....	139
E02.1.1. Prepared Slabs		E08. Interior Signs .....	139
E02.1.2. Natural Stone and Terrazzo		E08.1 Types and Color .....	139
E02.1.3. Quarry Tile		E08.2. Interior Signs Materials .....	140
E02.1.4. Ceramic Tile		E09. Lighting, Power and Communication .....	140
E02.1.5. Resilient Floor		E09.1. Functionality and Efficiency .....	140
E02.1.6. Carpet		E09.2. Types and Color .....	140
E02.1.7. Rapidly-Renewable Products		<b>F. Appendices .....</b>	<b>141</b>
E02.1.8. Other		<b>G. Appendices .....</b>	<b>143</b>
E03. Walls .....	125		
E03.1. Wall Materials .....	125		
E03.1.1. Concrete			
E03.1.2. Masonry			
E03.1.3. Ceramic Tile			
E03.1.4. Gypsum Board			
E03.1.5. Metal Panels			
E03.1.6. Wood Paneling			
E03.1.7. Rapidly-Renewable Products			
E03.1.8. Other			

## A. OVERVIEW

Comply with Air Force Corporate Standards for Overview:

<http://afcfs.wbdg.org/index.html>

This Installation Facilities Standards (IFS) document is part of the Air Force Corporate Facilities Standards (AFCFS) program to assist bases in implementing and maintaining facilities standards as appropriate for efficient operations within the respective climate region. IFS fully replaces, consolidates and simplifies existing facilities standards documents, such as the Architectural Compatibility Plan (ACP) or ACGs, FEPs, etc., and organizes information using the same structure, or Table of Contents, as the AFCFS website.

IFS reflects the AFCFS' concepts of "Facility Hierarchy" (categorizing facilities into group numbers) and "Facility Quality" (assigning an appropriate level of quality to each group number) and applies these principles at the base level. Applicable DoD and Air Force criteria such as UFCs, AFIs, Memoranda, and UFGSs (Guide Specs) are referenced and linked within IFS to ensure the document is always current.

Navigating within this IFS is efficient and straightforward. Please use the interactive Table of Contents to locate subject matter, and click on the title of a section to access it. From any page, click on the "Back to Table of Contents" footer to return. Content is organized into 4 major sections: Installation Elements, Site Development, Facilities Exteriors and Facilities Interiors.

This IFS document begins as a fill-in PDF form, which is fully editable, and becomes a "living document" that can be regularly updated by base-level personnel following a format that is consistent across the Air Force. While the format is standardized, IFS content is customized for base operations and the local climate to ensure mission success while emphasizing reduced maintenance and reduced initial costs, life-cycle costs, energy use, and water use.

1. Conformance to Air Force Corporate Facilities Standards (AFCFS) and Installation Facilities Standards (IFS) are required by Air Force Instruction (AFI) 32-1023 and Air Force Memorandum. Please refer to the AFCFS website for links to documentation on current policy.
2. Requests to deviate from any installation facilities standards, that are Unified Facilities Criteria (UFC) requirements, will follow the process outlined in the AFCFS for UFC waivers and exemptions.
3. All Air Force designs including Non-Appropriated Funds (NAF) facilities are required to conform to AFCFS per Air Force Instruction (AFI) 32-1023; AFCFS will be used to formulate Installation Facilities Standards (IFS) per the AFI. The Base Civil Engineer (BCE) maintains and implements the IFS.
4. Please refer to the AFCFS website as a portal to reference materials and requirements documents for design and construction projects (via links). Specific references to current DoD memoranda and Air Force criteria are updated periodically to provide the most current guidance and requirements. Programming, design and contract documents should list "current edition" for all reference and requirements documents. The documents in force at the date of execution of the design and/or construction contract shall be the governing version.
5. *Advanced Modeling Requirements:*  
*For all Air Force projects requiring advanced modeling, to include 3D visualization, Building Information Modeling (BIM), facility data, quantity take-off, geospatial, etc., follow the Army standards. Refer to USACE Minimum Model Matrix (M3) and Project Execution Plan (PxP) which outline required model uses. Refer to [CAD BIM Technology Center \(Contract Requirements\)](#) for more information on M3 and PxP.*
6. Joint Bases shall implement IFS under their Joint-Base designation with volume numbers for individual installations following the IFS Development Tool template. For example, for Joint Base Langley-Eustis, provide: Vol. 1 Langley AFB and Vol. 2 Fort Eustis.
7. References and Supplementary Documents listed in Appendix G are included in these Installation Facilities Standards by reference and are fully part of this document. Please refer to [Appendix G](#) for a listing of documents, which are available via hyperlink for viewing and downloading.
8. Installations outside the United States: Per UFC 1-200-01 DOD BUILDING CODE, 8 Oct 2019, "All construction outside of the United States is also governed by Status of Forces Agreements (SOFA), Host Nation Funded Construction Agreements (HNFA), and in some instances, Bilateral Infrastructure Agreements (BIA). Therefore, the acquisition team must ensure compliance with the most stringent of the UFC, the SOFA, the HNFA, and the BIA, as applicable." Refer to [Appendix G](#) for applicable agreements. "Use UFC 1-202-01 for design of host nation facilities that support military operations."  
<https://www.wbdg.org/ffc/dod/unified-facilities-criteria-ufc/ufc-1-202-01>

Applicable  N/A Select number of graphics / images (large: 800 px x 440 px) to insert 1

Image Tool 800 x 440

Applicable  N/A Select number of graphics / images (small: 250 px x 188 px) to insert 3

Image Tool 250 x 188



Main Gate near King-Graves Road



Group 3 Hangar



Predominant Use of Brick at Group 1



Group 2 Lodging

### **A01. FACILITY HIERARCHY**

Comply with AF Corporate Standards for Facility Hierarchy (and subsections):

<http://afcs.wbdg.org/facility-hierarchy/index.html>

### **A02. FACILITY QUALITY**

Comply with AF Corporate Standards for Facility Quality (and subsections):

<http://afcs.wbdg.org/facility-quality/index.html>

### **A03. FACILITY DISTRICTS**

Comply with AF Corporate Standards for Facility Districts (and subsections):

<http://afcs.wbdg.org/facility-districts/index.html>



Image Tool 800 x 800

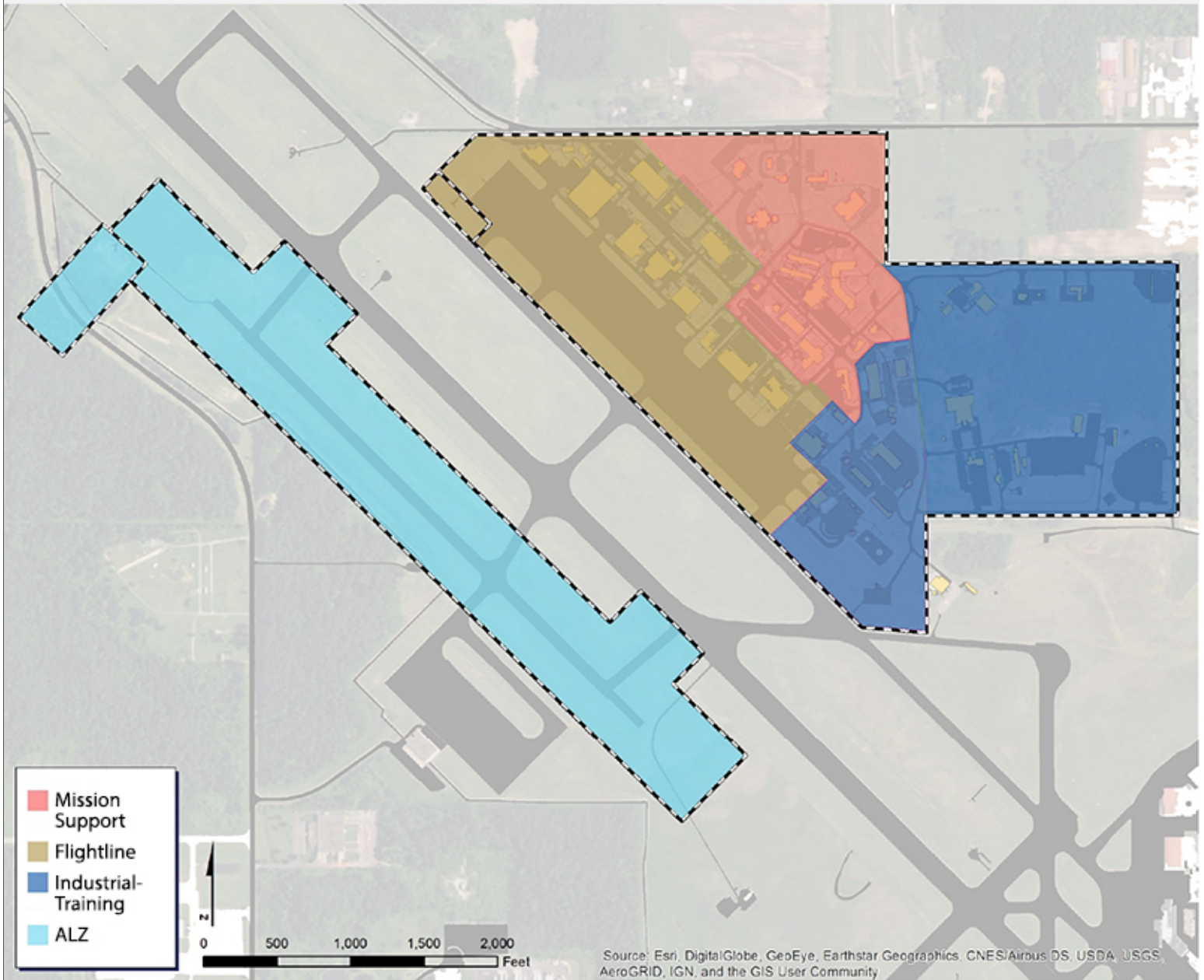

**Note:** Apply the base-wide standards in this IFS for Installation Elements, Site Development, Facilities Exteriors and Facilities Interiors (products, materials, color, etc.). Following application of the base-wide standards, refer to the Appendix and apply any additional requirements specifically related to the Facility District.

## B. INSTALLATION ELEMENTS

Comply with Air Force Corporate Standards for Installation Elements:

<http://afcs.wbdg.org/installation-elements/index.html>

### B01. COMPREHENSIVE PLANNING

Comply with Air Force Corporate Standards for Comprehensive Planning:

<http://afcs.wbdg.org/installation-elements/comprehensive-planning/index.html>

#### B01.1. Installation Development Plan (IDP)

Applicable  N/A Select number of graphics / images (large: 800 px x 440 px) to insert 1

Image Tool 800 x 440

Applicable  N/A Small graphics do not apply

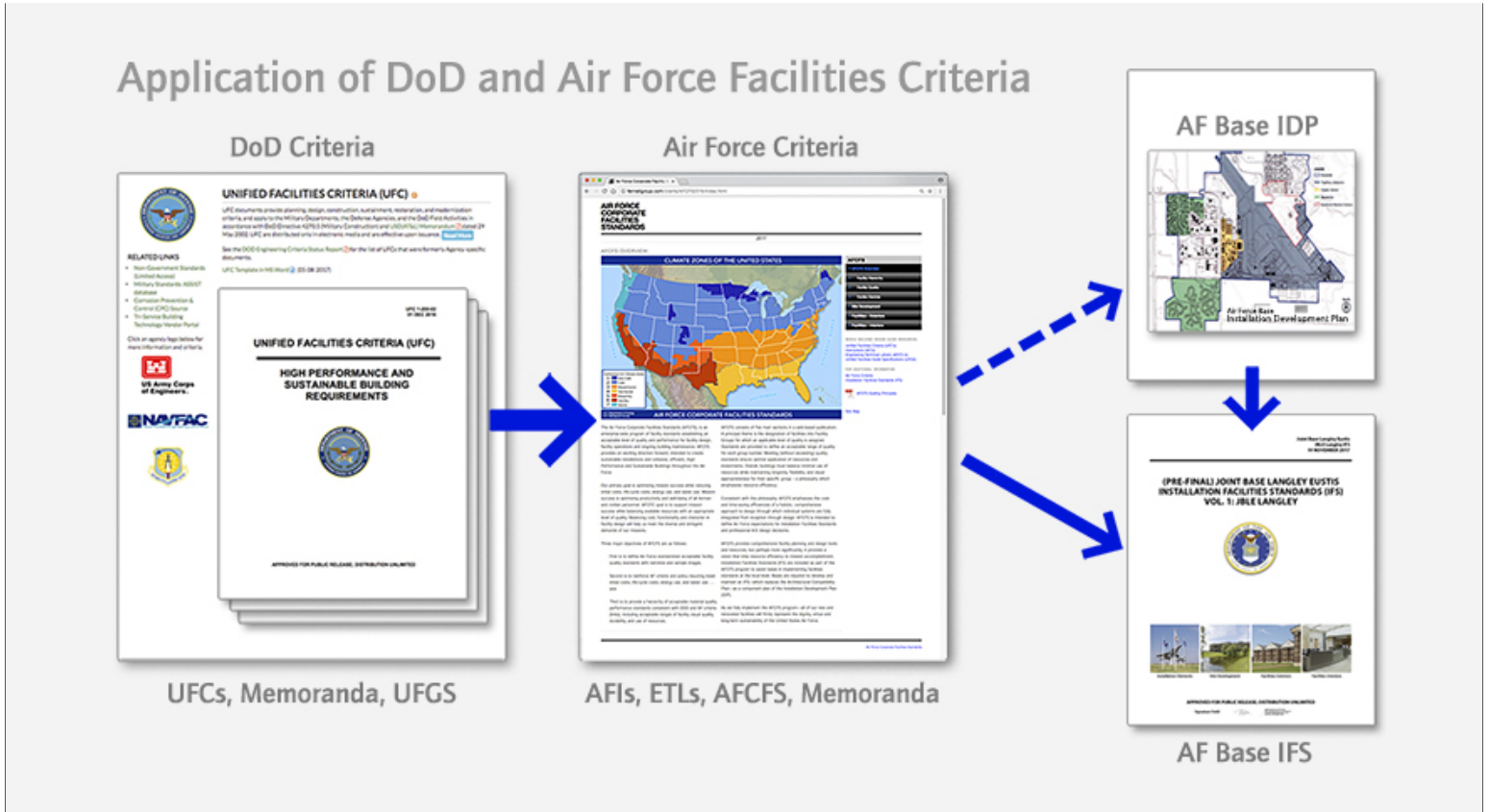

Department of Defense, Department of the Air Force and Air Force Base Criteria

1. The Base Civil Engineer is responsible for developing, maintaining and implementing the Installation Planning documents and to ensure that the Installation Development Plan (IDP) is prepared, maintained, and implemented following AFI 32-1015.
2. Refer to the IDP for information on climate and weather and for demographics and related data.

#### B01.1.1. IFS Component Plan of IDP

Applicable  N/A Large graphics do not apply

Applicable  N/A Small graphics do not apply

1. Comply with installation planning criteria, architectural compatibility and facilities standards.
2. All Air Force designs will conform to the standards specified in the Air Force Corporate Facilities Standards (AFCFS). AFCFS will also be used to formulate individual Installation Facilities Standards (IFS).
3. Maintain this Installation Facilities Standards (IFS) as required under AFI 32-1023. IFS is maintained and implemented by the Base Civil Engineer (BCE).
4. Address all infrastructure, site and facilities reuse opportunities in the IDP. Reuse designs will follow IFS.
5. Address all infill projects for infrastructure, site and facilities in the IDP. Infill designs will follow IFS.

### B01.1.2. Brief History of Base

Applicable  N/A Large graphics do not apply

Applicable  N/A Select number of graphics / images (small: 250 px x 188 px) to insert 3

Image Tool 250 x 188



Aerial Photograph of Youngstown ARS



Aircraft Training



Airdrop Training

There has been a continual military station presence in the Mahoning Valley area since 1917. The adjacent civil airport (Youngstown-Vienna Regional Airport) was constructed in 1933 under the Western Reserve Port Authority. A detachment of fighter planes was stationed here during World War II. After the War, a group of local Army Air Corps veterans formed the first Air Force Reserve unit here and it operated from the airport.

Construction on the current installation began in 1952 and Youngstown Air Force Base opened in 1953. In 1961, the control of the base was transferred from the active-duty Air Force to the newly formed Air Force Reserve, with the 910th Carrier Group as the "host" unit.

In the years since 1961, the 910th has had several missions operating many aircraft. The most significant change was in 1981, when the unit was redesignated as the 910th Tactical Airlift Group, flying C-130B Hercules. The unit converted to the "H" model of the C-130 in 1990. Recent historical milestones of the base include the addition of the Naval and Marine Corps Reserve units in 1989 and the acquisition of the Aerial spray mission in 1991. In 1994, the unit was redesignated the 910th Airlift Wing. Today the station is one of the largest employers in the tri-city area, with a direct annual economic impact of \$50 million. The aircraft of the 910th Airlift Wing fly across America and around the world on a daily basis, conducting tactical, humanitarian, and aerial spray missions.



### B01.1.3. Future Development

Applicable  N/A Select number of graphics / images (large: 800 px x 440 px) to insert 1

Image Tool 800 x 440

Applicable  N/A Small graphics do not apply



Aerial Image of Youngstown Air Reserve Station

1. Follow AFI 32-1015 for Air Force Comprehensive Planning, the Comprehensive Planning Process, Comprehensive Planning Requirements, and Geospatial Mapping.
2. Address all future development under the Installation Development Plan (IDP).

### B02. STREET ENVELOPE STANDARDS

Comply with Air Force Corporate Standards for Installation Elements:

<http://afcs.wbdg.org/installation-elements/index.html>

Comply with AF Corporate Standards for Street Envelope Standards:

<http://afcs.wbdg.org/installation-elements/street-envelope-standards/index.html>

## B02.1. Hierarchy of Streets

Applicable  N/A Large graphics do not apply

Applicable  N/A Select number of graphics / images (small: 250 px x 188 px) to insert 3

Image Tool 250 x 188

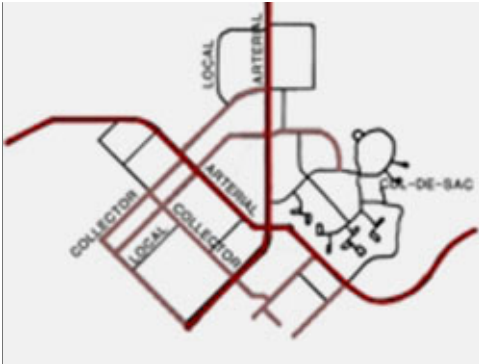

Hierarchy of Streets

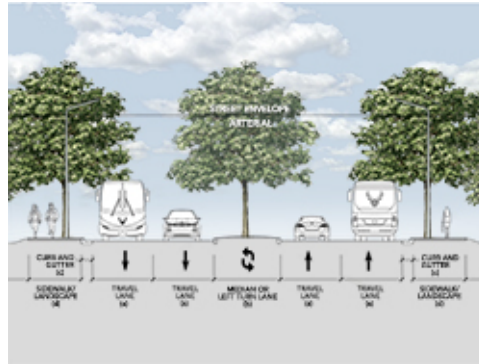

Street Envelope Section



Special Route at Main Gate

1. Develop and evolve a hierarchical transportation network of arterial, collector and local streets following UFC 3-201-01 and its industry references.
2. Provide consistent functionality throughout the installation and a level of visual quality relating to the adjacent Facility Group number.
3. Routes along facilities in Group 1 may have materials, finishes and features with a higher visual quality than Groups 2, 3 and 4. Reduce maintenance requirements by installing highly durable materials and finishes in routes along Group 3 industrial facilities.
4. Special routes may have a visual quality comparable to those along facilities in Group 1.
5. Create and maintain arterials with two lanes of traffic in each direction with landscaped or paved medians as applicable to the local climate and adjacent facility group designation / land use.
6. Minimize stops and turns along arterials. Eliminate on-street parking along arterials and provide on collector streets only on lower speed roadways such as residential streets.
7. Connect arterials to local streets with appropriately scaled collector streets.
8. Provide appropriate landscape setbacks and pedestrian buffers along all streets.
9. Minimize and consolidate curb cuts along streets.
10. Ensure access for emergency and service vehicles.
11. Define bicycle traffic routes in the Installation Development Plan or its applicable component plans.
12. Define appropriate force protection features, site furnishings, signs, lighting, utilities, and paving in the IFS.



## B02.1.1. Arterial Streets

Applicable  N/A Select number of graphics / images (large: 800 px x 440 px) to insert 1

Image Tool 800 x 440

Applicable  N/A Select number of graphics / images (small: 250 px x 188 px) to insert 3

Image Tool 250 x 188

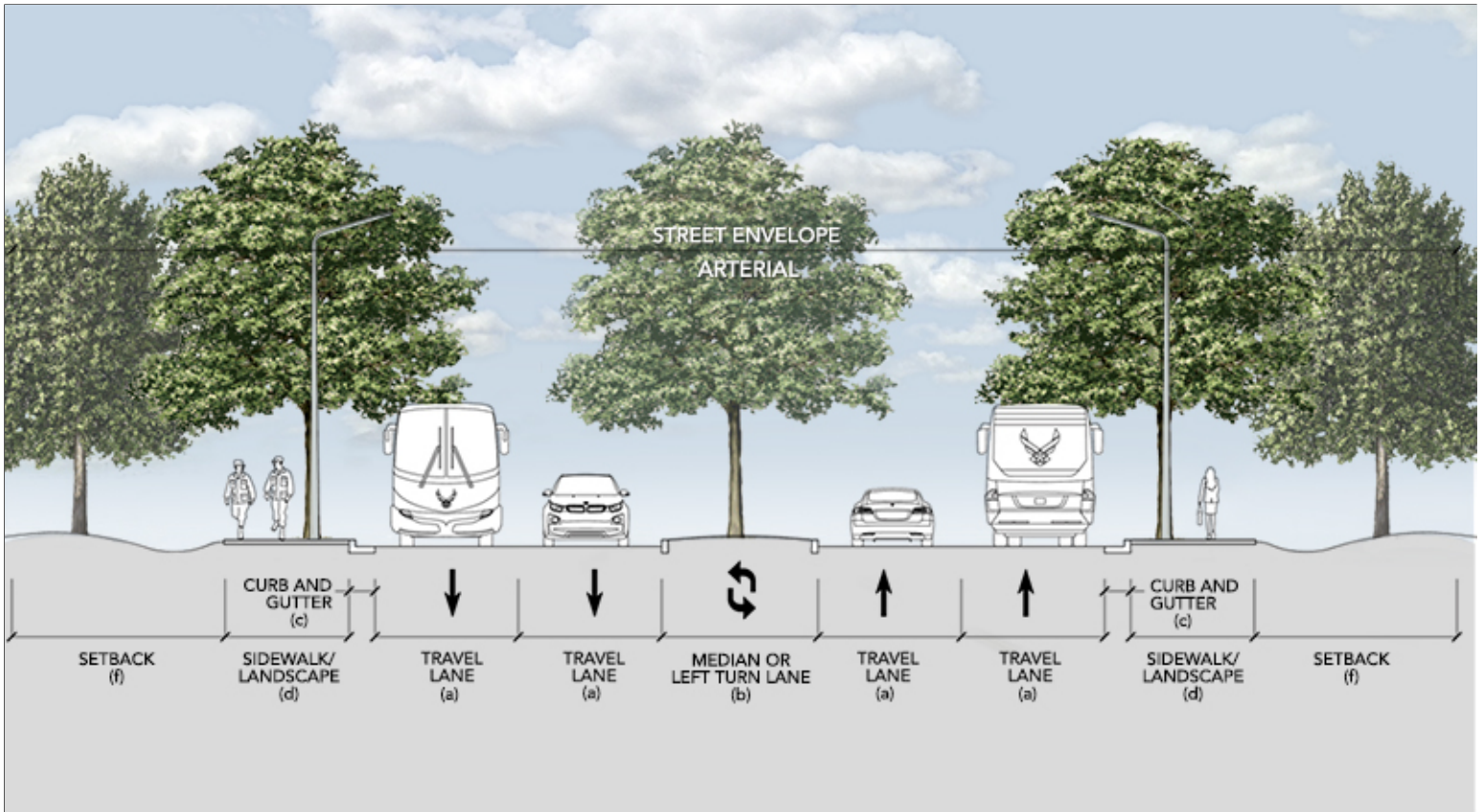

Travel Lane (a): 12' Median (b): 12' Curb and Gutter (c): 2' Sidewalk / Landscape (d): 12' Setback (f): Min. 35' or per AT

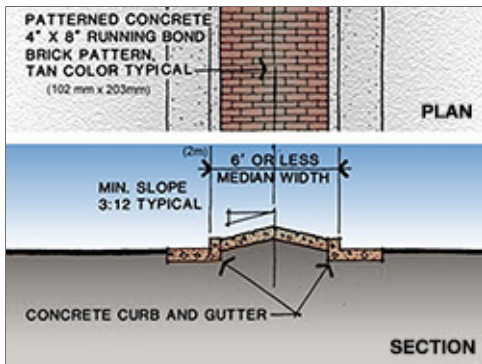

Paved Median



Two-Lane Arterial near Main Gate



Coordinated Street Elements

1. Stops and turns should be minimized and on-street parking will not be allowed at any point along arterial streets.
2. Provide sidewalks on at least one side of arterial streets and both sides of arterial streets in developed areas. Provide a 6' buffer between the road and sidewalk where space allows.
3. Limit curb cuts on arterial streets to entries into major facilities, building groups and major parking areas.
4. Reinforce the importance of arterial streets with appropriate signs, plantings and street lighting.

**B02.1.2. Collector Streets**

Applicable  N/A Select number of graphics / images (large: 800 px x 440 px) to insert 1

Image Tool 800 x 440

Applicable  N/A Select number of graphics / images (small: 250 px x 188 px) to insert 3

Image Tool 250 x 188

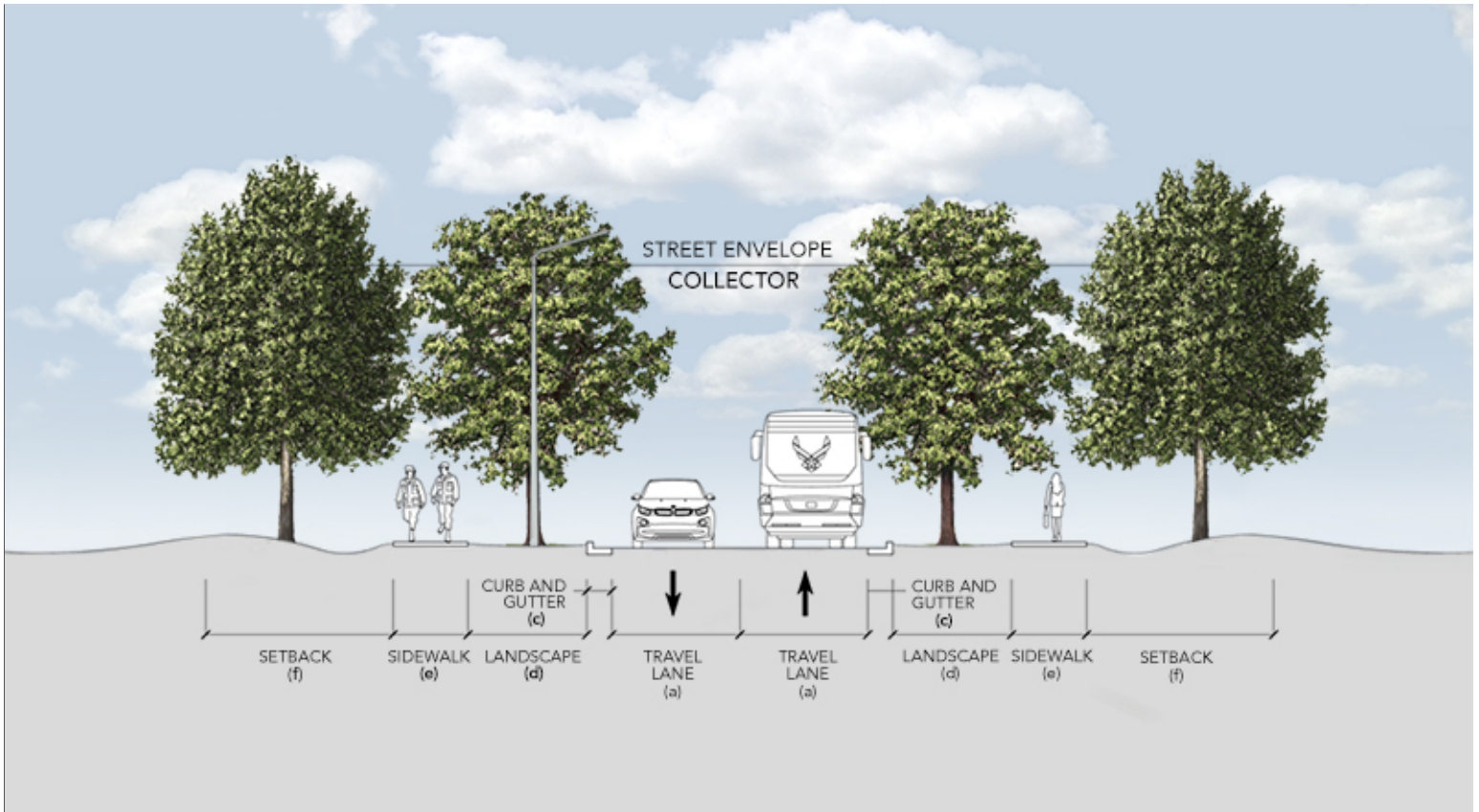

Travel Lane (a): 12' Median (b): N/A Curb and Gutter (c): 2' Landscape (d): 10' Sidewalk (e): 6' Setback (f): Min. 35' or per AT



Integrated Landscape



Coordinated Parking



Installation Flagpole at Terminus

1. Frequent traffic stops and low speeds are permitted on collector streets.
2. Provide sidewalks on at least one side of collector streets and both sides of collector streets where functionally required. Buffers are preferred but not required on collector streets.
3. On-street parking may be allowed on one side where secondary roads are not less than 34 feet wide. Parking will not interfere with intersections or traffic flow.



4. Signs, plantings and street lighting should reinforce the designation of “collector” street.

### B02.1.3. Local Streets

Applicable  N/A Select number of graphics / images (large: 800 px x 440 px) to insert 1

Image Tool 800 x 440

Applicable  N/A Select number of graphics / images (small: 250 px x 188 px) to insert 3

Image Tool 250 x 188

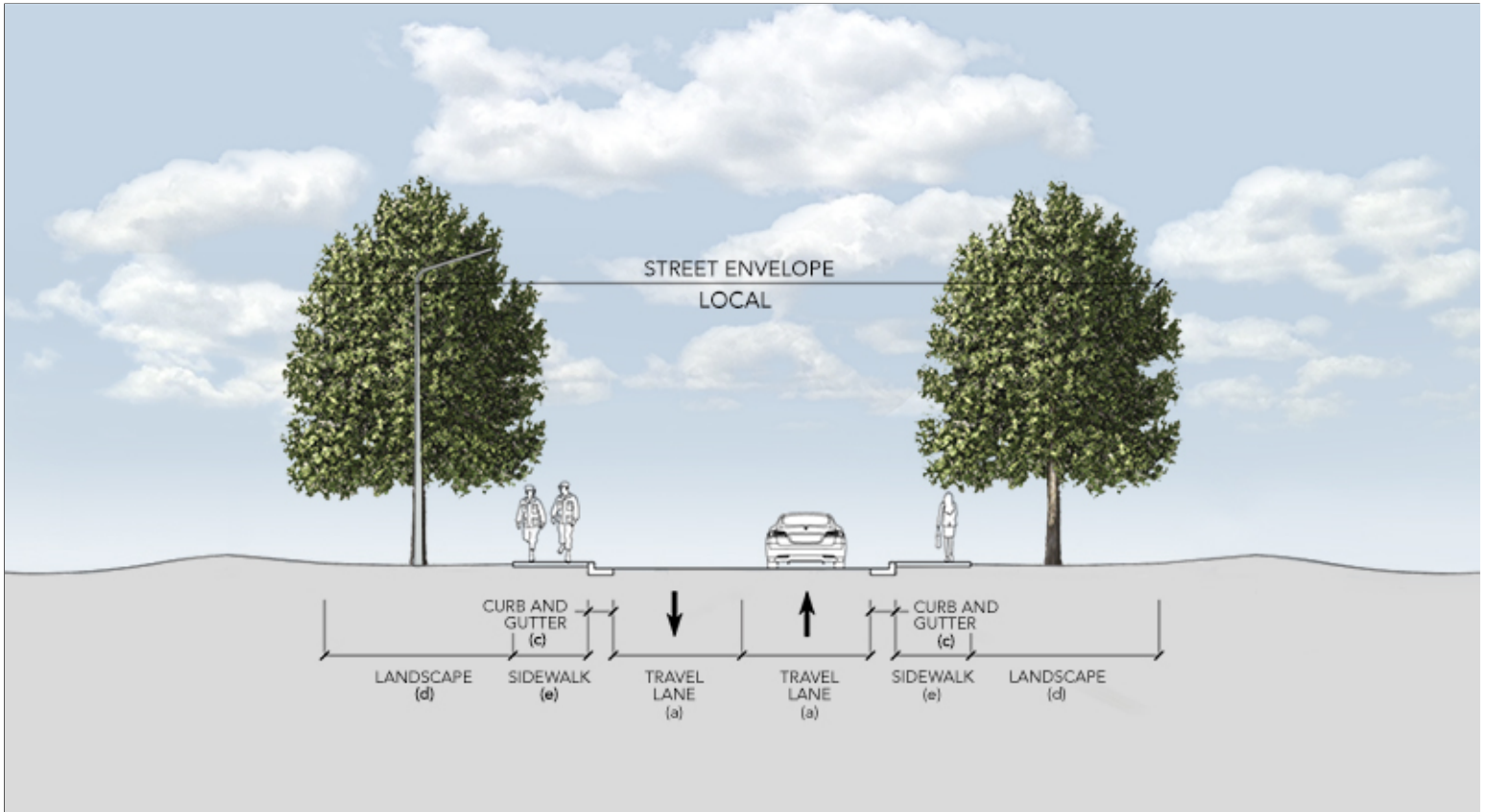

Travel Lane (a): 11' Median (b): N/A Curb and Gutter (c): 1.5' Landscape (d): 15' Sidewalk (e): 6'



Maintained Landscape



On-Street Parking



Fencing Integrated with Setback

1. Frequent traffic stops and low speeds are permitted on local streets.
2. Provide sidewalks on at least one side of local streets and both sides of local streets where functionally required. Buffers are preferred but not required on local streets.
3. On-street parking may be allowed following UFC industry references.

4. Signs, plantings and street lighting should reinforce the designation of "local" street.

5. Cul-de-sacs are only permitted in family housing areas.

#### **B02.1.4. Special Routes**

Applicable  N/A Select number of graphics / images (large: 800 px x 440 px) to insert 1

Image Tool 800 x 440

Applicable  N/A Small graphics do not apply



Route along Perimeter Fence

1. Develop all special routes consistently with those adjacent to Group 1 facilities.
2. Maintain the trees, grasses, landscape beds, trails and setback areas as applicable along special routes.

#### **B02.2. Hierarchy of Intersections**

Applicable  N/A Large graphics do not apply

Applicable  N/A Small graphics do not apply

1. Provide a hierarchy of intersections to include arterial, arterial-collector, collector, collector-local and local following UFC 3-201-01 and its industry references.
2. Passive systems such as traffic circles are preferred to active systems such as signalized intersections. Aggressively pursue passive systems to lower maintenance requirements and reduce energy use.



3. Use a level of visual quality for an intersection equal to the quality found in the related streetscape, which corresponds to the adjacent Facility Group number.

**B02.2.1. Arterials**

Applicable  N/A Select number of graphics / images (large: 800 px x 440 px) to insert 1

Image Tool 800 x 440

Applicable  N/A Select number of graphics / images (small: 250 px x 188 px) to insert 3

Image Tool 250 x 188



Coordinated Signs, Lighting and Other Street Elements



Offset T Intersections



Detached Sidewalk



Sign in Landscaped Median

1. At arterial intersections adjacent to Group 1, landscaping of native grasses and shrubs may be provided; trees may be included when maintenance and non-potable irrigation is available. Monuments and static displays may be integrated into arterial intersection designs.



## B02.2.2. Arterial/Collector

Applicable  N/A Select number of graphics / images (large: 800 px x 440 px) to insert 1

Image Tool 800 x 440

Applicable  N/A Select number of graphics / images (small: 250 px x 188 px) to insert 3

Image Tool 250 x 188



Typical Intersection with Coordinated Street Elements



Landscape Setback



Coordinated Sidewalk and Lighting



Integrated Utilities and Signs

1. At arterial/collector intersections adjacent to Group 1, landscaping of native grasses and shrubs may be provided; trees may be included when maintenance and non-potable irrigation is available.

### B02.2.3. Collectors

Applicable  N/A Large graphics do not apply

Applicable  N/A Select number of graphics / images (small: 250 px x 188 px) to insert 3

Image Tool 250 x 188



Coordinated Signs and Striping



Standard Street Elements



Access to Facility

1. At collector intersections adjacent to Group 1, landscaping of native grasses and shrubs may be provided; trees may be included when maintenance and non-potable irrigation is available. Intersections adjacent to Group 2 may be developed similarly, but with less detailing.

### B02.2.4. Special Intersections

Applicable  N/A Large graphics do not apply

Applicable  N/A Small graphics do not apply

1. Develop all special intersections consistently with those adjacent to Group 1 facilities.

### B02.2.5. Street Frontage Requirements

Applicable  N/A Large graphics do not apply

Applicable  N/A Select number of graphics / images (small: 250 px x 188 px) to insert 3

Image Tool 250 x 188



Maintained Landscape Setback



Attached Sidewalk



Coordinated Placement of Elements

1. Consistently maintain open space buffers following B03.2.3. Preserves.



2. Refer to C06.1.7. Streetscape Landscaping for planting and screen wall requirements along street frontage.

### B02.2.6. Sight Lines

Applicable  N/A Select number of graphics / images (large: 800 px x 440 px) to insert 1

Image Tool 800 x 440

Applicable  N/A Select number of graphics / images (small: 250 px x 188 px) to insert 3

Image Tool 250 x 188



Street Tree Placement Preserving Sight Lines



Preserved Sight Lines



Coordinated Placement of Elements



Predominant Use of Grasses

1. Provide adequate sight lines for an effective and safe traffic operation per American Association of State Highway and Transportation Officials (AASHTO) standards and local municipality guidelines.



### B02.3. Street Elements

Applicable  N/A Select number of graphics / images (large: 800 px x 440 px) to insert 1

Image Tool 800 x 440

Applicable  N/A Small graphics do not apply



Coordinated Placement of Signs, Lighting, Landscaping, Storm Drainage and Pedestrian Circulation

1. Emulate the streetscape area's pre-development hydrology using passive and active design features to help sustain the adjacent regionally appropriate landscape. Coordinate with the base Stormwater Management Plan.
2. Employ systems, materials and techniques to maximize streetscape sustainability. Consider pervious paving and high reflectivity of surfaces, which are appropriate for the local climate.
3. Install at-grade curbing and/or raised-profile curb and gutter as applicable to direct stormwater to bioswales and rain gardens as source water for vegetation. Do not paint concrete curbing.
4. Provide all on-site utility service lines and equipment below grade when adjacent to Facility Group 1. In routes along Group 2, 3 and 4, when mounting elements such as utility cabinets, communications equipment and water valves above grade is unavoidable, paint these consistently and provide visual screening following Installation Facilities Standards (IFS).
5. Provide traffic control devices including access control point/entry control facility signs, speed limit signs and street name signs following the current edition of the Manual on Uniform Traffic Control Devices (MUTCD) per UFC 3-120-01.
6. Crosswalk markings will follow the MUTCD for Streets and Highways, current edition. Provide white markings that define the edges of the crosswalk or a tone of lines defining the area of the crosswalk consistent with common practices found in the adjacent municipality.
7. Follow UFC 3-120-01 for directional and wayfinding signs and address both vehicular and pedestrian traffic.

8. Reduce energy consumption and reduce maintenance requirements by providing street lighting only when functionally required to ensure safety and to address antiterrorism following UFC 4-010-01. Ensure the quality and quantities of lighting and fixtures are appropriate for the adjacent Facility Group number.

### B02.3.1. Paving

Applicable  N/A Large graphics do not apply

Applicable  N/A Small graphics do not apply

1. Pavement design will comply with UFC 3-250-01. Ensure appropriate analysis and design of subgrade conditions to promote low maintenance, high performance pavements. Apply all applicable best practices from Appendix B of the UFC.
2. Materials will be specified in accordance with UFC 3-250-01 and must conform to requirements set forth in the Unified Facility Guide Specifications (UFGS) for concrete and bituminous pavement.

### B02.3.2. Curb and Gutter

Applicable  N/A Large graphics do not apply

Applicable  N/A Select number of graphics / images (small: 250 px x 188 px) to insert 3

Image Tool 250 x 188

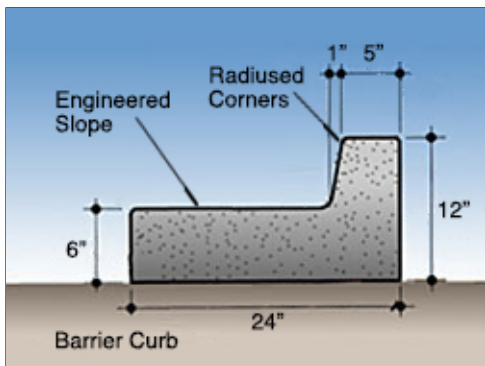

Standard Curb

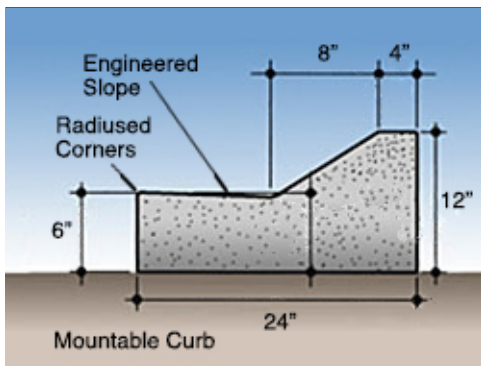

Mountable Curb

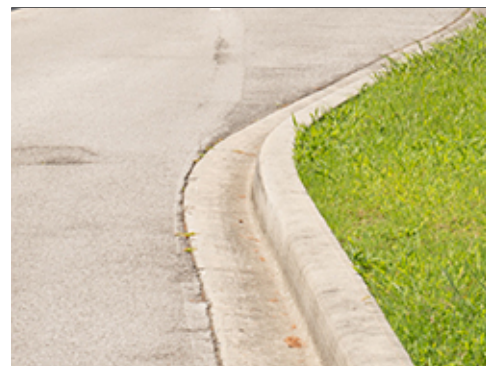

Typical Curbing

1. Curb all streets except remote/isolated roads and rock-paved service roads.
2. All streets should have integral concrete curbs and gutters. Painted curbs are prohibited because they are very difficult to maintain.
3. Use concrete for sidewalks and curbs. Do not use asphalt curbs.



### B02.3.3. Utility Service Elements

Applicable  N/A Large graphics do not apply

Applicable  N/A Select number of graphics / images (small: 250 px x 188 px) to insert 3

Image Tool 250 x 188



Standard Cabinet Placement and Color



Inconspicuous Location



Standard Hydrant and Color

1. Provide all utility service lines below grade when streets are adjacent to Facility Group 1; when mounting elements (such as utility cabinets, communications equipment and water valves) above grade is unavoidable, paint these consistently and provide visual screening following Site Development, Landscaping.

2. Overhead service lines along streets adjacent to Facility Groups 2, 3 and 4 are discouraged.

### B02.3.4. Traffic Signs

Applicable  N/A Large graphics do not apply

Applicable  N/A Select number of graphics / images (small: 250 px x 188 px) to insert 3

Image Tool 250 x 188



Coordinated Intersection Signs



Standard Traffic Device



Standard Placement

1. Refer to Exterior Signs, Colors and Types for Traffic Control Devices, which includes signs.

### B02.3.5. Street Lighting

Applicable  N/A Large graphics do not apply

Applicable  N/A Select number of graphics / images (small: 250 px x 188 px) to insert 3

Image Tool 250 x 188



Single Mast



Double Mast



Uniform Spacing

1. Refer to the Lighting section for appropriate applications along streets.

### B02.3.6. Other

Applicable  N/A Large graphics do not apply

Applicable  N/A Small graphics do not apply

### B03. OPEN SPACE / PUBLIC SPACE

Comply with Air Force Corporate Standards for Installation Elements:

<http://afcfs.wbdg.org/installation-elements/index.html>

Comply with AF Corporate Standards for Open Space / Public Space:

<http://afcfs.wbdg.org/installation-elements/open-space-public-space/index.html>



### B03.1. Plazas, Monuments and Static Displays

Applicable  N/A Select number of graphics / images (large: 800 px x 440 px) to insert 1

Image Tool 800 x 440

Applicable  N/A Select number of graphics / images (small: 250 px x 188 px) to insert 3

Image Tool 250 x 188



Brick with Concrete Edging at Plaza Entrance to Group 1



Entrance Plaza with Bike Rack



Commemorative Marker and Display



Plaza at Group 2 Facility

1. Natural features and culturally or historically significant features or events may be recognized and acknowledged with physical elements such as plazas, monuments and static displays. However, limit these elements on the base to ensure judicious use of resources and to reduce ongoing maintenance requirements.
2. Design highly durable plazas, monuments and static displays with a level of quality comparable to Facility Group 1.
3. Link plazas, monuments and static displays to the pedestrian circulation system. Install landscaping, site furnishings and lighting appropriate for the application and local climate following Installation Facilities Standards (IFS).



4. Select systems, products and materials for paving, walls, and structures following IFS.

### B03.1.1. Paved Plazas

Applicable  N/A Select number of graphics / images (large: 800 px x 440 px) to insert 1

Image Tool 800 x 440

Applicable  N/A Select number of graphics / images (small: 250 px x 188 px) to insert 3

Image Tool 250 x 188



Tan Colored Concrete at Group 2



Red Pavers at Group 1



Stamped Colored Concrete



Red Unit Pavers

1. Mitigate heat island effect by providing high-albedo, shaded plazas. Pervious pavers will be used on all plazas and courtyards in Facility Groups 1 and 2; use pervious concrete in Group 3. The designer will incorporate appropriate expansion and construction joints.
2. Pavers will match the color of pavers used on adjacent sidewalks using the base standard red blend at Group 1 and tan blend at Group 2. Brick used on plazas will typically be 4" x 8" size or interlocking polygon pavers.



### B03.1.2. Sculptures, Markers and Statuary

Applicable  N/A Large graphics do not apply

Applicable  N/A Select number of graphics / images (small: 250 px x 188 px) to insert 3

Image Tool 250 x 188



Brick Piers with Markers



Bronze Plaque on Precast Panel



Precast Panel with Relief

1. Relate new sculpture, markers and statuary to the base's architectural design theme. Generally, limit these elements to frequently used locations adjacent to Facility Group 1 and highly traveled community pedestrian spaces.
2. Consider entry gates as possible sites for new displays.
3. All proposed memorials will follow AFI 36-3108 and be limited to highly deserving individuals or groups as deemed appropriate by the installation leadership. Living memorials (tree plantings / etc.) are discouraged due to added maintenance requirements.
4. When sculpture requires a base, match the materials and / or color palette of adjacent buildings.
5. Use direct or indirect lighting to accentuate features or enhance an intended effect.
6. Ensure that all sculpture, markers and statuary are honorable and inspiring, provide a sense of place, positively contribute to the base's visual quality, and encourage pride for the community and the US Air Force.

### B03.1.3. Static Display of Aircraft

Applicable  N/A Large graphics do not apply

Applicable  N/A Small graphics do not apply

1. Follow IFS base-wide standards for all elements of the display area with specific attention to traffic sight lines, pedestrian circulation, site furnishings, signs, and lighting. Address requirements for the Facility District as well.
2. Generally, locate concrete base/foundation structures for static displays below grade.
3. At static displays where pedestrian paths are provided, a minimum of one trash receptacle and one bench will be provided. Receptacle and bench design must conform to IFS requirements.

## B03.2. Grounds and Perimeters

Applicable  N/A Select number of graphics / images (large: 800 px x 440 px) to insert 1

Image Tool 800 x 440

Applicable  N/A Select number of graphics / images (small: 250 px x 188 px) to insert 3

Image Tool 250 x 188



Open Space at Airfield with Woodland Buffer Beyond



Natural Forming Woodland at Perimeter



Maintained Landscape along Perimeter



Decorative Fencing near Group 1 Facility

1. Provide formal spaces for parade and review functions, recreational areas and parks following the base's Installation Development Plan (IDP) and Installation Facilities Standards (IFS). Refer to the Site Furnishings topic for additional information.
2. Maintain preservation areas following the IDP and IFS.
3. Comply with UFC 4-010-01 DoD Minimum Antiterrorism Standards for Buildings and UFC 4-022-03 Security Fences and Gates for all elements associated with the base's gates and perimeter fence.

4. Identify and describe base-wide utility corridors in the IDP.
5. Base-wide utility infrastructure will be inconspicuous. Bury utility service lines below grade when adjacent to Facility Group 1 and when economically feasible for Facility Groups 2, 3 and 4. When service lines are located above grade, create an ordered, coordinated appearance.
6. Follow the requirements of this IFS regarding all utility structures and service lines located above grade that visually impact the installation.
7. Where screening of utility equipment and structures is provided, allow adequate and proper clearance for safety and maintenance.
8. Reduce visual clutter and visual impact of the following items through a combination of careful placement, screen walls, landscaping and painting:
  - Electrical switch-stations
  - Sewage lift stations
  - Water well pumps, storage tanks and/or related structures
  - Gas piping, meters and similar incidental items
  - Above ground fuel storage tanks
  - Any ground-mounted freestanding utility item exposed to view
9. Larger structures such as electrical switch-stations, sewage lift stations, fuel storage tanks and mechanical/electrical equipment will be screened from view, using materials, forms, and colors in the screen walls that match those respective design elements present at adjacent buildings.
10. Paint aboveground equipment and associated components such as electrical piping or exposed plumbing lines dark bronze.
11. Maintain existing buried utility service lines as a visual asset.
12. Bury the following exposed above-grade items in future projects when economically feasible:
  - Electrical power grid and service lines
  - Telephone lines
  - Cable TV lines
  - Communications lines
  - Exterior lighting service lines
  - Any similar system of above-ground lines serving the base
13. Consolidate and enclose service utility lines in underground utility corridors when feasible. Create routes along the inside edge of parking lot islands.
14. All development of open space requires prior coordination and approval from the Base Civil Engineer.

### **B03.2.1. Parade Grounds**

Applicable  N/A Large graphics do not apply

Applicable  N/A Small graphics do not apply

1. Follow UFC 3-201-02, Appendix B for the planning and design process and criteria for parade grounds.
2. Establish and maintain parade grounds only where there is a confirmed need and provide landscape materials appropriate for the locale following IFS.



3. Bleachers may be installed only when there is a documented requirement at parade grounds. Nonferrous metals that do not require painting or ongoing maintenance are preferred. The Base Civil Engineer will determine quantities, sizes, and products on a case basis.

### B03.2.2. Parks

Applicable  N/A Large graphics do not apply

Applicable  N/A Select number of graphics / images (small: 250 px x 188 px) to insert 3

Image Tool 250 x 188



Pavilion with Coordinated Site Furnishings



Standard Playground Equipment



Picnic Tables at Pavilion

1. Bleachers may be installed only when there is a documented requirement at parks and fields for recreational events. Follow guidance under Parade Grounds.
2. Picnic pavilions may be provided in parks where there is a documented need.
3. Prohibited picnic pavilion materials include wood, concrete masonry units (CMU) or metal pre-manufactured storage sheds. Use only materials and detailing that are low maintenance and endure with minimal weathering.
4. When picnic pavilions are permitted near facilities, generally match the architecture of the adjacent facility and provide a level of quality of the adjacent facility group number.

### B03.2.3. Preserves

Applicable  N/A Large graphics do not apply

Applicable  N/A Small graphics do not apply

1. Preserve areas adjacent to runways, taxiways, aprons, golf course roughs, storage areas, antenna facilities, and ammunition storage areas as open space.
2. Provide minimal maintenance with mowing as needed for controlling bird behavior for airfield safety or eliminating fire hazards.



### B03.2.4. Perimeter Fence

Applicable  N/A Select number of graphics / images (large: 800 px x 440 px) to insert 1

Image Tool 800 x 440

Applicable  N/A Select number of graphics / images (small: 250 px x 188 px) to insert 3

Image Tool 250 x 188



Coordinated Perimeter Fencing and Landscaping at Group 1



Group 3 Fencing



Chain Link Fencing Components



Fencing with Gate System

1. Design, install and maintain the base's perimeter fence following UFC 4-022-03. Maintain a positive visual quality along the traffic corridor on both sides of the main gates. Specifically address pedestrian access, circulation and common areas.
2. Stringently comply with AT requirements following UFC 04-010-01 for all spaces adjacent to the base's perimeter fence and all gates.
3. Fencing, gates and other elements that are associated with the main gates will be a level of quality equivalent to Facility Group 1.



## C. SITE DEVELOPMENT

Comply with Air Force Corporate Standards for Site Development:  
<http://afcs.wbdg.org/site-development/index.html>

### C01. SITE DESIGN

Comply with Air Force Corporate Standards for Site Development:  
<http://afcs.wbdg.org/site-development/index.html>

Comply with AF Corporate Standards for Site Design / NEPA:  
<http://afcs.wbdg.org/site-development/site-design-nepa/index.html>

#### C01.1. Site Design Considerations

Applicable  N/A Large graphics do not apply

Applicable  N/A Small graphics do not apply

1. Collect documentation to validate approvals and completion of the NEPA process.
2. Ensure site design compliance with the Installation Development Plan (IDP) and its component plans and Installation Facilities Standards (IFS).
3. Promote integrated design with on-site solutions such as engineered small-scale hydrologic controls versus base-wide infrastructure; consider open space, natural features, bioswales, building roofs, streets, and paved surfaces, and snow storage areas.
4. Integrate snow storage areas with adjacent streets and parking areas; coordinate snow storage with the base stormwater plan.
5. Limit the impact of development on land and water resources. All site elements and infrastructure will reinforce an image of sustainability, with reduced energy demand, renewable-energy usage, and water conservation.
6. Consider energy conservation during site design for the following categories: building and site lighting, auxiliary systems and equipment (refrigerators, elevators, etc.), building envelope, electric power and distribution, HVAC systems and equipment, service hot water, and energy management (metering, EMCS).
7. Coordinate on-site renewable-energy systems and components to minimize area requirements and maximize efficiencies. Appropriately buffer and screen these and other mechanical systems and equipment.
8. New building projects should preserve open space and protect natural habitat.
9. Conform to existing topography to the greatest extent possible and use slopes to increase site and building efficiencies. Design sites to minimize irrigation and impacts to stormwater runoff.
10. Carefully study new project sites to identify the character of adjacent buildings, streets, landscaping, and site design elements. Reinforce the existing character in new site design.
11. Consider relationships to adjacent facilities and district / centralized heating and cooling infrastructure and cost effectively connect building systems to harvest heat, grey water or other beneficial byproducts.
12. Minimize existing and planned obstructions from landscaping, structures, topography, and adjacent developments to preserve solar access and natural ventilation.
13. Purposefully integrate service access, receiving and storage areas to eliminate the need for visual screening.
14. Appropriately connect to the base network of streets, sidewalks and trails using drive aisles, parking areas, walkways, paths, and bicycle routes addressing both vehicles and pedestrians.

15. Applicably coordinate heat island mitigation in paving and roof designs when implementing an integrated approach to stormwater management.

16. Consider the location of "Designated Tobacco Areas."

### C01.2. Building Orientation

Applicable  N/A Select number of graphics / images (large: 800 px x 440 px) to insert 1

Image Tool 800 x 440

Applicable  N/A Select number of graphics / images (small: 250 px x 188 px) to insert 6

Image Tool 250 x 188

#### DRIVING FACTORS

- |  |  |  |   |
|--|--|--|---|
| • Optimal solar orientation of the building.   | • Maximize the daylight & desirable views.       | • Meet the required AT/FP standoff distance          | • Create a unified campus                       |
| • Main entrance from Pepperrell street.        | • Saving existing vegetation and trees           | • Separation between staff/public/materials entrance | • Outdoor healing environment                   |
| • Addressing the orientation of the future ACC | • Visibility of the new facility from main roads | • Required parking spaces for public and staff       | • Implementation of landscape zones A, B, C & D |

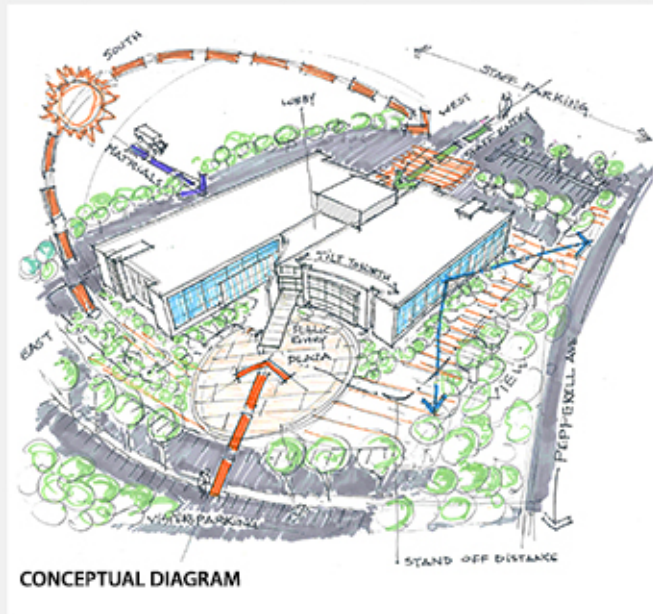

Conceptual Site Analysis and Site Design Diagram

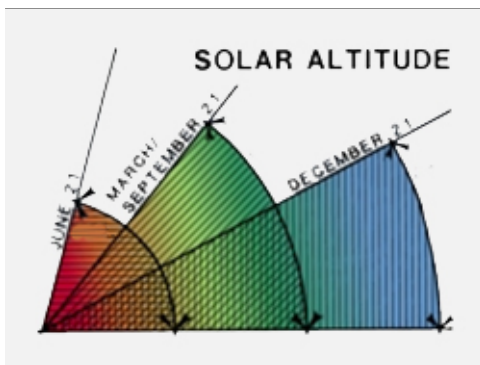

Local Solar Data

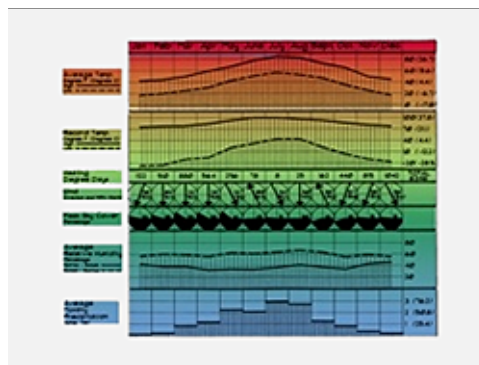

Local Climate Data

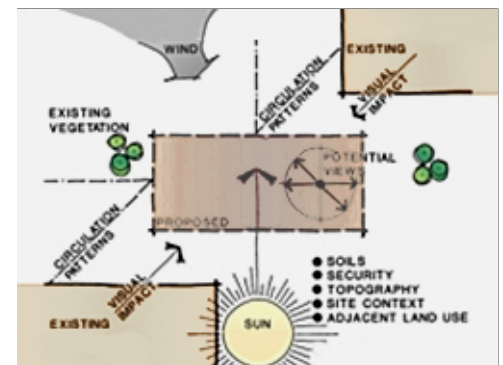

Site Data



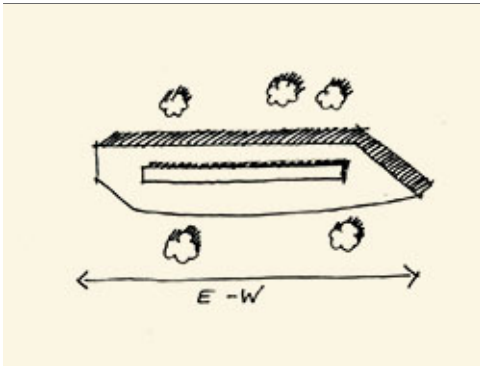

East-West Axis

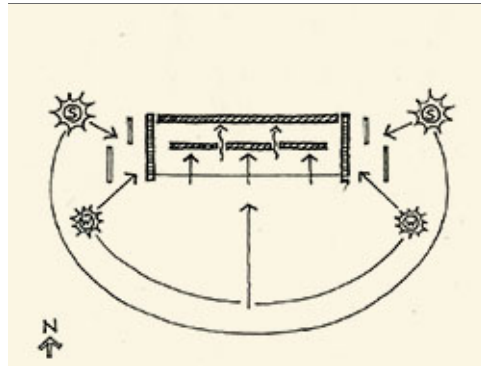

Optimum Solar Control

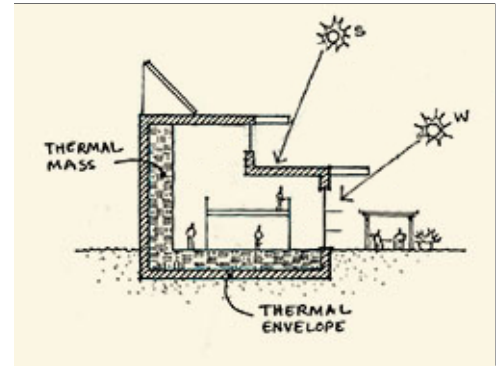

Maximized Shading

1. Ensure the site will accommodate optimum requirements for building orientation, which is with the long axis parallel to the east/west direction for rectilinear CONUS buildings.
2. Meet Installation Facilities Standards (IFS) requirements for the locations of the building's passive and renewable-energy systems --including geothermal and solar systems --and exterior shading systems.
3. Locate the building(s) and permitted ancillary structures to promote solar gain, solar shading, natural ventilation, rainwater harvesting, wind buffering and other beneficial passive systems. Consider natural ventilation during the design of HVAC systems.
4. Consider relationships to adjacent sites and their facilities and infrastructure, and cost effectively integrate building systems to harvest heat, grey water or other beneficial byproducts.
5. Consider the "public side" of the building, its views and the location of the main entrance.

## C02. UTILITIES

Comply with AF Corporate Standards for Site Development:

<http://afcs.wbdg.org/site-development/index.html>

Comply with AF Corporate Standards for Utilities:

<http://afcs.wbdg.org/site-development/utilities/index.html>

### C02.1. Utility Components

Applicable  N/A Large graphics do not apply

Applicable  N/A Select number of graphics / images (small: 250 px x 188 px) to insert 3

Image Tool 250 x 188



Water Service Element



Overhead Utility Lines



Buried Utility Lines to Cabinet at Group 1

1. Provide all on-site utility service lines below grade for Facility Group 1; when mounting elements (such as utility cabinets, communications equipment and water valves) above grade is unavoidable, paint these consistently and provide visual screening following Installation Facilities Standards (IFS).
2. Provide installation of utility infrastructure to support near term and future electric vehicle charging stations.
3. Define all service entry points into the building and route distribution below grade into an interior space within the facility; exposed conduits, cables and wires on exterior walls are not permitted for Facility Group 1.
4. Include consideration of appropriate placement of meters in support of Automated Revenue Management Services (ARMS).
5. Limit exterior mechanical distribution systems such as exterior steam, chilled water, and hot water distribution to Group 3 facilities; when required for Group 1 and 2 facilities integrate with the architecture and provide visual screens following IFS.
6. Direct roof drainage to bioswales or underground collection when feasible or provide splash blocks / paved channels to intercept roof drainage at grade.

### C03. PARKING AREAS

Comply with AF Corporate Standards for Site Development:

<http://afcs.wbdg.org/site-development/index.html>

Comply with AF Corporate Standards for Parking Areas:

<http://afcs.wbdg.org/site-development/parking-areas/index.html>

#### C03.1. Configurations and Design

Applicable  N/A Large graphics do not apply

Applicable  N/A Select number of graphics / images (small: 250 px x 188 px) to insert 3

Image Tool 250 x 188

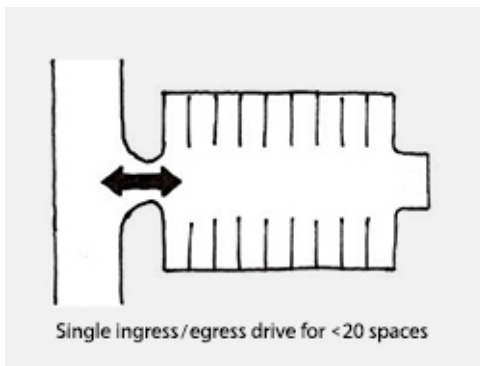

Small Lot Configuration

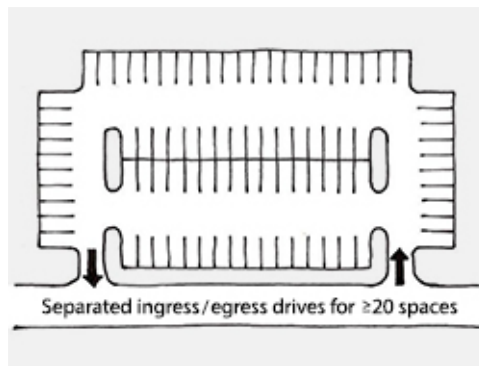

Large Lot Configuration

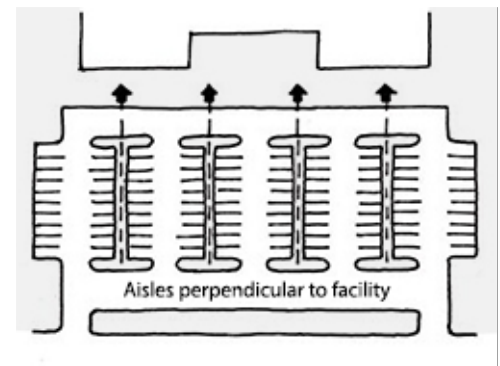

Facility Group 1 Configuration

1. Evaluate adjacent sites and cost-effectively consolidate parking areas to maximize efficient use; ensure that all areas meet accessibility guidelines.
2. Generally envision on-site parking as a series of small connected singular areas selectively placed around the facility served, rather than a single large area; buffer parking areas from the facility main entrance with a transition space and provide drop-offs to decrease close-in parking. Comply with IFS standards while meeting requirements.
3. Integrate at-grade and raised-profile curbing, permeable paved areas, and parking islands with the stormwater system and direct stormwater to bioswales and rain gardens as source water for regionally appropriate native vegetation. Configure curbing to facilitate snow removal. Ensure snow storage areas are coordinated with the stormwater plan.



4. Define pedestrian access with approved hardscape and provide shading along the primary path from the parking area to the building's main entrance of the building.
5. Coordinate suitable landscape or barriers integrated with walls and fences to ensure adequate force protection.
6. Accessible parking spaces will be marked according to UFC 3-120-01 and its references in ABAAS and the MUTCD.
7. Consider locations and requirements of near term and future electric vehicle charging stations.
8. Designate preferred parking spaces for electric vehicles and carpools near the main entrance.
9. Consider cost-effectively integrating solar photovoltaic arrays into covered parking structures.
10. Reserved parking is discouraged except for Facility Group 1.
11. On-street parking is discouraged except in multi-use areas. When used, provide approved on-street parking configurations following UFC 3-201-01.
12. Access and service drives should accommodate the largest vehicle serving the facility.

### C03.1.1. Paving and Striping

Applicable  N/A Large graphics do not apply

Applicable  N/A Select number of graphics / images (small: 250 px x 188 px) to insert 3

Image Tool 250 x 188



Standard Asphalt Paving with White Striping



Accessible Parking Striping and Graphics



Aisle and Curb Ramp

**Facility Group 1** paving materials shall be as follows.

Primary: Asphaltic Concrete

Secondary: Concrete

Accent: Permeable pavers

**Facility Group 2** paving materials shall be as follows.

Primary: Asphaltic Concrete

Secondary: N/A

Accent: N/A

**Facility Group 3** paving materials shall be as follows.

Primary: Concrete where Operationally Required

Secondary: Asphaltic Concrete

Accent: N/A

**Facility Group 4** paving materials shall be as follows.

Primary: N/A

Secondary: N/A

Accent: N/A

1. All new parking lots in Groups 1 and 2 will be constructed of bituminous pavement, or concrete pavement where functionally required, following UFC 3-250-01.
2. Porous paving may be considered on a case basis.
3. Cost-effectively provide light-colored concrete to reduce heat island effect; otherwise install bituminous pavement. Dirt, gravel, and grass lots are not allowed.
4. Use consistent striping, angles and stall sizes in all parking areas.
5. All parking will be marked with white stripes of paint or applied vinyl coatings. Red or yellow markings will only be used for safety purposes and must be kept to a minimum. All lines will be four inches (4") wide.

**C03.1.2. Curbing**

Applicable  N/A Large graphics do not apply

Applicable  N/A Select number of graphics / images (small: 250 px x 188 px) to insert 3

Image Tool 250 x 188

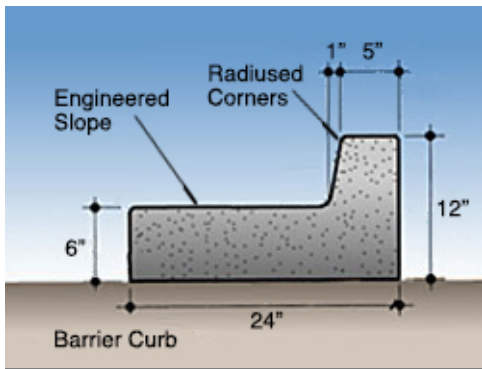

"Barrier" Curb

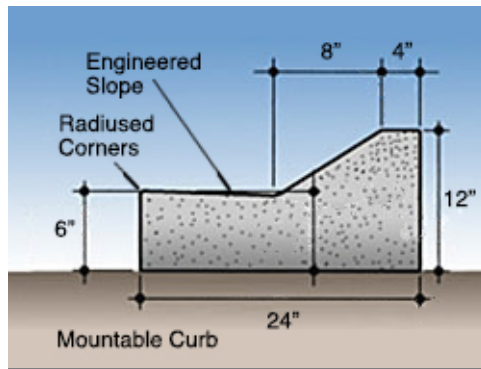

"Mountable" Curb

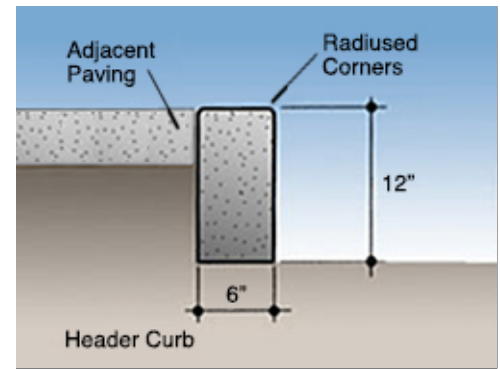

Header Curb

**Facility Group 1** curbing / edging materials shall be as follows.

Primary: Concrete

Secondary: N/A

Accent: N/A

**Facility Group 3** curbing / edging materials shall be as follows.

Primary: Concrete

Secondary: N/A

Accent: N/A

**Facility Group 2** curbing / edging materials shall be as follows.

Primary: Concrete

Secondary: N/A

Accent: N/A

**Facility Group 4** curbing / edging materials shall be as follows.

Primary: N/A

Secondary: N/A

Accent: N/A

1. Define all parking lots with either raised-profile or at-grade curbing to promote drainage and protect paving edges. All raised curbs will be the rolled (mountable) type.
2. Integrate curbing to direct stormwater to bioswales and rain gardens as source water for regionally appropriate native vegetation.



- 3. Wheel stops are not permitted except at locations where car bumpers could contact adjacent items such as poles, signs or pedestrians.

### C03.1.3. Internal Islands and Medians

Applicable  N/A Large graphics do not apply

Applicable  N/A Select number of graphics / images (small: 250 px x 188 px) to insert 3

Image Tool 250 x 188



Grass Median



Xeric Planting with Rock Mulch



Rock Mulch

1. Install landscape islands and medians as visual breaks, to reduce heat island effects and to accommodate bioswales and rain gardens with consideration for snow storage and removal. Coordinate suitable landscape or barriers integrated with walls and fences to ensure adequate force protection.
2. When lighting is necessary, contain fixture bases within medians or internal landscape islands.

### C03.2. Parking Structures

Applicable  N/A Large graphics do not apply

Applicable  N/A Small graphics do not apply

1. Parking structures are encouraged in land-constrained locations when economically feasible.
2. Consider near- term and future electric vehicle charging stations and renewable energy generation development during the analysis and design.
3. Consider opportunities for integrating parking structures into multi-use developments with pedestrian-oriented uses located on the ground floor and parking on upper levels; ensure AT guidelines are fully addressed.
4. Structures may be constructed below grade with roofs serving as vegetated areas or plazas.

### C03.3. Connectivity

Applicable  N/A Large graphics do not apply

Applicable  N/A Small graphics do not apply

1. Refer to the Installation Development Plan (IDP) for locations of transit stops and pedestrian and cycling networks; provide appropriately sized sidewalks and bike paths to connect facilities and users to these networks.
2. Provide amenities such as rain and shade shelters, trees, and benches to encourage and facilitate use of public transportation.
3. Evaluate the IDP for the current and planned network of roads and optimally develop vehicular access to and from the site.

#### C04. STORMWATER MANAGEMENT

Comply with AF Corporate Standards for Site Development:

<http://afcs.wbdg.org/site-development/index.html>

Comply with AF Corporate Standards for Stormwater Management:

<http://afcs.wbdg.org/site-development/stormwater-management/index.html>

##### C04.1. Stormwater Requirements

Applicable  N/A Large graphics do not apply

Applicable  N/A Select number of graphics / images (small: 250 px x 188 px) to insert 3

Image Tool 250 x 188



Stormwater Element



Site Grading to Inlet



Standard Inlet Grate

1. Design all stormwater systems including retention ponds, detention areas, channels, etc. as on-site amenities that are consistent with natural systems and drainage patterns, that help sustain the base landscape with beneficial functionality and that provide aesthetic appeal; coordinate with the base Stormwater Management Plan.
2. Incorporate bioswales into the design of all roadway, parking and facility roof systems to enhance water quality and support the overall stormwater system.
3. Permeable paving may be used in areas that are not subjected to severe freeze-thaw cycles.
4. Provide rainwater harvesting and storage that is attached to the building's roof drain systems to support grey water irrigation; consider freeze protection for winter months.
5. When underground drainage systems are required establish a maintenance program to include removal of sediments and debris; inspect joints seasonally for alignment to prevent leakage and the development of voids and surface failures.
6. Cost-effectively integrate stormwater systems with AT measures.



## C05. SIDEWALKS, BIKEWAYS AND TRAILS

Comply with AF Corporate Standards for Site Development:

<http://afcs.wbdg.org/site-development/index.html>

Comply with AF Corporate Standards for Sidewalks, Bikeways and Trails:

<http://afcs.wbdg.org/site-development/sidewalks-bikeways-trails/index.html>

### C05.1. Circulation and Paving

Applicable  N/A Select number of graphics / images (large: 800 px x 440 px) to insert 1

Image Tool 800 x 440

Applicable  N/A Select number of graphics / images (small: 250 px x 188 px) to insert 6

Image Tool 250 x 188



Curvilinear Sidewalk with Integrated Landscape, Lighting, Signs, and Anti-terrorism Measures



Sidewalk at Entrance with Seating



Controlled Pedestrian Access



Intersecting Sidewalks at Street Corner



Paving Width Relating to Use



Landscaping and Fence Defining Space



Standard Curb Ramp

**Facility Group 1** sidewalks, plazas, and courtyards paving materials shall be as follows.

Primary: Pervious Pavers

Secondary: Concrete Edging

Accent: N/A

**Facility Group 2** sidewalks, plazas, and courtyards paving materials shall be as follows.

Primary: Pervious Pavers

Secondary: Concrete Edging

Accent: N/A

**Facility Group 3** sidewalks, plazas, and courtyards paving materials shall be as follows.

Primary: Permeable Concrete

Secondary: N/A

Accent: N/A

**Facility Group 4** sidewalks, plazas, and courtyards paving materials shall be as follows.

Primary: N/A

Secondary: N/A

Accent: N/A

1. Maintain efficient geometry and accessibility to connect building entrances to adjacent parking areas and activity areas and to the base transportation system following AT. Efficiently use materials to optimize life-cycle costs and to minimize maintenance.
2. Generally conform horizontal layouts of sidewalks to the geometric configuration of adjacent buildings, streets, parking lots, and other adjacent related site amenities. Occasional meanders and/or jogs may be included to capture views, to coordinate with landscaping or accommodate site constraints.
3. Walks in parking areas will provide a direct path using "safe islands" and "peninsulas" to encourage safety. Walks parallel to streets will follow streetscape guidelines. Clearly mark pedestrian crossings at vehicular routes.
4. Mitigate heat island effect by providing high-albedo, shaded sidewalks. Pervious pavers will be used on all sidewalks, plazas and courtyards in Facility Groups 1 and 2; use pervious concrete in Groups 3 and 4. The designer will incorporate appropriate expansion and construction joints.
5. Only experienced contractors will install pervious pavements.
6. Consider an integrated approach that could include stormwater management (permeable surfaces) and complement the design of the storm drainage system when appropriate.
7. Pedestrian paths should be at least 5' in width to allow for comfortable side-by-side walking.
8. Sidewalks leading to a building main entrance and at the interior of parking lots will be a minimum width of 6'. Walks greater than 10' wide may be used at high-density pedestrian areas where volumes of traffic justify added material.



9. Where vehicles park adjacent and head-in to the sidewalk and wheel stops are not used, such perimeter walks will be increased to a minimum width of 8' to accommodate overhangs of the parked vehicles.
10. All sidewalks will have positive drainage to prevent ponding of water with slopes ranging from 2.1% to 4.2%. Walks with a slope greater than 4.2% will be designed as ramps following accessibility guidelines. All walks will have a minimum cross slope of 2.1%.
11. Pavers will conform to the following range of color: red blend for Group 1 and tan blend for Group 2. Pavers used on walks will typically be 4" x 8" size.
12. Connect to the bicycle circulation system and provide bicycle parking with a suitable means for securing bicycles following IFS. Consider changing/shower facilities for use by cyclists.
13. Refer to the Installation Development Plan for future trails, bicycle paths, and sidewalks.

### C05.1.1. Ramps and Stairs

Applicable  N/A Large graphics do not apply

Applicable  N/A Select number of graphics / images (small: 250 px x 188 px) to insert 3

Image Tool 250 x 188



Ramp with Masonry Walls



Site Ramp with Railing



Site Accommodating Grade

1. Use ramps instead of stairs for sidewalks, bikeways and trails and at all buildings where possible. Where steps are unavoidable, follow UFC 1-200-01 and its references to the International Building Code.

### C05.1.2. Lighting

Applicable  N/A Large graphics do not apply

Applicable  N/A Small graphics do not apply

1. Provide lighting for all stairs and landings where traffic warrants.
2. Refer to the Lighting section for path lighting along sidewalks, bikeways and trails.



## C06. LANDSCAPE

Comply with AF Corporate Standards for Site Development:

<http://afcs.wbdg.org/site-development/index.html>

Comply with AF Corporate Standards for Landscape:

<http://afcs.wbdg.org/site-development/landscape/index.html>

### C06.1. Climate-based Materials

Applicable  N/A Select number of graphics / images (large: 800 px x 440 px) to insert 1

Image Tool 800 x 440

Applicable  N/A Select number of graphics / images (small: 250 px x 188 px) to insert 3

Image Tool 250 x 188



Roof Drainage Directed through Downspouts to Bioswale with Native Species



Indigenous Species Providing Shade



Native Trees, Shrubs and Grasses



Seasonal Color



1. Use only native, naturally occurring, drought tolerant indigenous plant species (including grasses) appropriate for the locale to promote energy efficiency and water conservation, preserve drainage patterns, inhibit erosion, improve air quality, lower maintenance, and add beauty.

2. Follow details and specifications of the American Standard for Nursery Stock, current edition.

### C06.1.1. Landscape Design Concept

Applicable  N/A Select number of graphics / images (large: 800 px x 440 px) to insert 1

Image Tool 800 x 440

Applicable  N/A Select number of graphics / images (small: 250 px x 188 px) to insert 3

Image Tool 250 x 188



Trees for Shading and Wind Buffering



Pedestrian Scaled Plantings



Native Drought Tolerant Species



Deciduous Trees for Seasonal Shading



1. Develop, maintain and implement a climate-based plant list with landscape features using a regionally appropriate palette of materials to promote energy efficiency, preserve drainage patterns, inhibit erosion, improve air quality, lower maintenance and add beauty. Follow UFC 3-201-02 Landscape Architecture.
2. Landscaping is required for all newly developed sites and facilities; preserve existing native landscape where possible and avoid overplanting.
3. Concentrate landscaping in Facility Group 1 and along major thoroughfares and integrate these landscaped areas into the base's stormwater management plan. Refer to the Streetscape Envelope Standards in this IFS.
4. All Facility Group 1 sites will be landscaped at their entire perimeter; limit formal planting arrangements to formal spaces typically associated with Group 1. Landscape public spaces near the main entrances of Group 1 facilities.
5. Facility Group 2 and 3 sites may have a native undisturbed landscape except at the main entrances of Group 2, which should be newly landscaped.
6. Facility plantings will follow the Installation Facilities Standards (IFS) plant list, which is based on the specific microclimates created by the adjacent building: shadow areas, protected areas, zones adjacent to thermal mass, and availability of rainwater and/or grey water.
7. Provide open spaces as transitions between developed and native areas that promote quality of life and provide visual relief and allow walkable connections to the transportation system.
8. Return suitable areas to a natural state to minimize and, whenever possible, eliminate ground maintenance requirements; expand prairie areas where appropriate with native plants to eliminate mowing and maintenance requirements.
9. In tree clusters replace grass with naturalized shrub beds and leaf litter mulch to eliminate mowing requirements.
10. Use plantings in open spaces to reinforce the space as a visual asset.
11. Consider landscape windbreaks when suitable for the local climate.
12. Integrate security requirements into the landscape design. Coordinate the heights of trees and shrubs and note restrictions for plantings following UFC 4-010-01.
13. Berms may be used as an integral part of the overall landscape strategy for screening, security and/or visual interest.

### C06.1.2. Xeriscape Design Principles

Applicable  N/A Large graphics do not apply

Applicable  N/A Select number of graphics / images (small: 250 px x 188 px) to insert 3

Image Tool 250 x 188



Xeric Planting with Organic Mulch



Drought Tolerant Species and Rock Mulch



Species with Low Water Requirements



1. Apply xeriscape principles following UFC 3-201-02, Appendix B, and Air Force Corporate Facilities Standards.
2. Facility plantings are encouraged to use native plant species and to consider specific microclimates created by the adjacent building: shadow areas, protected areas, zones adjacent to thermal mass, and availability of rainwater and/or grey water.

### C06.1.3. Minimizing Water Requirements

Applicable  N/A Large graphics do not apply

Applicable  N/A Select number of graphics / images (small: 250 px x 188 px) to insert 3

Image Tool 250 x 188



Drought Tolerant Species



Rock Mulch with Directed Rainwater



Slope Stabilized with Rock Mulch

1. Reasonably reduce demand on potable water while seeking opportunities to increase alternative water sources for irrigation. Reduce or eliminate the use of potable/domestic water for purposes of landscape architecture maintenance, consistent with existing legal or contractual obligations, and prohibit potable-water irrigation in new construction beyond establishment following current DoD and Air Force policy.

### C06.1.4. Plant Material Selection

Applicable  N/A Large graphics do not apply

Applicable  N/A Select number of graphics / images (small: 250 px x 188 px) to insert 3

Image Tool 250 x 188



Drought Tolerant Species



Deciduous and Evergreen Species



Ornamental Shrub with Seasonal Color

1. Use only native, naturally occurring plant materials including grasses or turf suited for the local climatic conditions in the landscape design; potable-water irrigation systems are discouraged beyond the establishment period.

2. New facilities are encouraged to use native plant species as indicated on the plant list available from the Civil Engineer Squadron.
3. Trees should be the focus of landscape plantings and, where possible, should be a mix of deciduous and evergreen species for variety; provide tree grates when appropriate and use tree guards on smaller trees.
4. Ground covers are only recommended when minimal maintenance is required.
5. Turf areas should be limited to those that can be sustained by natural rainfall or grey water (non-potable) irrigation systems; turf may be defined by at-grade concrete mow strips to lessen maintenance.
6. Analyze soils and provide organic amendments as needed to improve plant growth and conserve water.
7. All plant material will have one-year warranty and is subject to approval by the Base Landscape Architect.

### C06.1.5. Water Budgeting (Hydrozones)

Applicable  N/A Large graphics do not apply

Applicable  N/A Select number of graphics / images (small: 250 px x 188 px) to insert 3

Image Tool 250 x 188



Mulched Planting Bed



Foundation Planting with Mulch



Xeric Species

1. Comply with DoD and Air Force policy on potable-water irrigation systems.
2. Provide irrigation systems in new construction to establish plant materials following "Water for Landscaping" in UFC 1-200-02. Note the climate zone and annual rainfall for the locale.
3. New buildings will cost-effectively integrate a grey-water reclamation system following UFC 1-200-02, which provides source water for an automatic drip irrigation system; connect adaptive plantings adjacent to facilities to a grey-water irrigation system when available and discontinue the use of potable water for irrigation after the establishment period.
4. Provide irrigation design following UFC 3-201-02. Install drip irrigation products and components following UFGS Section 32 84 24 Irrigation Sprinkler Systems. Match the color of valve box lids to the adjacent ground treatment (i.e. green at turf & native seed areas, brown at wood mulch & rock areas).
5. Life cycle cost-effectively equip irrigation systems to sense soil moisture, rainfall and wind to minimize unnecessary watering; incorporate drip irrigation systems as the primary source.



### C06.1.6. Base Entrance Landscaping

Applicable  N/A Select number of graphics / images (large: 800 px x 440 px) to insert 1

Image Tool 800 x 440

Applicable  N/A Select number of graphics / images (small: 250 px x 188 px) to insert 3

Image Tool 250 x 188



Landscape Integrated with Security and Anti-terrorism Measures



Predominant Use of Grasses



Deciduous Trees for Shading



Preserved Sight Lines

1. At the main gate, reinforce a sense of arrival through a well-designed concentration of landscape elements consistent in visual quality with Facility Group 1.
2. Ensure landscaping has seasonal features with spring and fall color and a combination of evergreen and deciduous trees and shrubs for winter interest.
3. Integrate base signs and street and pedestrian lighting whenever feasible.



### C06.1.7. Streetscape Landscaping

Applicable  N/A Large graphics do not apply

Applicable  N/A Select number of graphics / images (small: 250 px x 188 px) to insert 3

Image Tool 250 x 188



Deciduous Species



Grasses and Trees in Setback



Regular Spacing of Street Trees

1. Provide landscape designs with plant materials appropriately representing the level of quality of the adjacent Facility Group number. Refer to the Installation Elements section.
2. Select a variety of regionally appropriate streetscape plantings and grading to create a visual interest.

### C06.1.8. Pedestrian Circulation Landscaping

Applicable  N/A Large graphics do not apply

Applicable  N/A Select number of graphics / images (small: 250 px x 188 px) to insert 3

Image Tool 250 x 188



Pedestrian Scaled Planting



Grasses, Shrubs and Trees



Ornamental Planting at Group 2 Lodging

1. Define walkways with landscaping where appropriate.
2. Provide rest areas along the pedestrian circulation network with human-scaled deciduous shade trees. Supplement tree plantings with finely textured shrubs when appropriate for the climate.
3. Provide wind breaks where required.



### C06.1.9. Parking Lot Landscaping

Applicable  N/A Large graphics do not apply

Applicable  N/A Select number of graphics / images (small: 250 px x 188 px) to insert 3

Image Tool 250 x 188



Predominant Use of Native Grasses



Trees for Screening and to Define Space



Drought Tolerant Shrubs

1. Integrate appropriate landscaping elements into parking areas to visually soften the appearance at a minimum rate of 5 percent of the total area.
2. Avoid trees that drop sap, fruit, or seeds, and use long-lived species; keep trees trimmed, removing dead and dying trees or branches.
3. Provide planting in islands within parking lots for shade and appeal following IFS and the base stormwater management plan.
4. Rain garden islands will be landscaped to receive snowmelt and rainwater runoff from adjacent impervious parking areas to be absorbed into the ground/planting bed. Native plants and groundcovers are recommended within the rain garden areas, which can survive without supplemental irrigation once established.

### C06.1.10. Screen/Accent Landscaping

Applicable  N/A Large graphics do not apply

Applicable  N/A Select number of graphics / images (small: 250 px x 188 px) to insert 3

Image Tool 250 x 188



Accent Planting to Define Entrance



Visual Screening of Mechanical Equipment



Partial Screening and Accent Planting

1. Provide complimentary accent landscaping at monuments and static displays.
2. At Facility Group 1, provide landscaping adjacent to all freestanding signs without distracting from the written communication.

3. Provide landscape screening of utility elements adjacent to Facility Group 1.

4. Providing landscaping as visual screening is preferred to the construction of walls and fences; berming and mounding may supplement landscape screening.

**C06.1.11. Other**

Applicable  N/A Large graphics do not apply

Applicable  N/A Small graphics do not apply

**C07. SITE FURNISHINGS**

Comply with AF Corporate Standards for Site Development:  
<http://afcfs.wbdg.org/site-development/index.html>

Comply with AF Corporate Standards for Site Furnishings:  
<http://afcfs.wbdg.org/site-development/site-furnishings/index.html>

**C07.1. Furnishings and Elements**

Applicable  N/A Select number of graphics / images (large: 800 px x 440 px) to insert 1

Image Tool 800 x 440

Applicable  N/A Select number of graphics / images (small: 250 px x 188 px) to insert 3

Image Tool 250 x 188



Coordinated Site Furnishings





Consistent Use of Elements



Standard Shelter and Furnishings



Standard Bus Shelter

1. Provide a coordinated consistent inventory of site furnishings to positively contribute to the visual environment, image, and identity of the base; ensure durability, low maintenance, reduced visual clutter, and compatibility with the adjacent architecture.
2. Remove poorly located or redundant litter / ash receptacles, newspaper and bicycle racks, telephone booths, vending machines, walls and fences to reduce visual clutter and to lessen the requirements for maintenance.
3. Group 1, 2, and 3 site furnishings will be medium bronze powder coated metal. Generally match the site furniture of adjacent facilities and the facility district.
4. Install needed outdoor seating (benches and low walls) in public gathering spaces near main and secondary building entrances. Low walls will match facility architecture.
5. Benches in Groups 1, 2, 3 and parks will be medium bronze powder coated metal. Recycled plastic benches May be provided in Group 2, 3 and parks.
6. Integrate functional bicycle racks with the design of the building's main entrance grounds in Facility Groups 1 and 2 while meeting AT requirements.
7. Limit the use of bollards, but when necessary for force protection use medium bronze round dome top designs in Groups 1 and 2; Clad steel pipe bollards in Group 3; cast iron bollards may be used in parks and trails. Illuminated bollards may be used as approved on a case basis.
8. Locate architecturally coordinated containers for recycling, litter, ash, vending, etc., to minimize visual clutter and not be visible from the building's main entrance. Minimize the use of freestanding planters.
9. Generally limit picnic tables, barbeque grills and drinking fountains to lodging, dormitories, housing areas, parks and recreation areas following IFS.
10. The Installation Flagpole location will comply with the guidance for the display of flags in AFI 34-1201. Each Air Force installation is authorized to fly one United States Flag, normally in front of the installation headquarters. Waivers for non-authorized locations must be submitted in accordance with AFI 33-360 and approved waivers (AF Form 679) must be maintained by the installation protocol office.
11. Flagpoles using approved materials may be installed at locations designated by IFS, and in accordance with AFI 34-1201.
12. Refer to the Overview Section "Facility Hierarchy" topic of this AFCFS for guidelines regarding ancillary structures such as pavilions and shade shelters.
13. Bus shelters will be provided only where there is a documented need and when approved on a case basis. Generally emulate the designs of adjacent shelters using dark bronze aluminum framed, domed roof structures.
14. Monuments and static displays will be limited. New elements are generally discouraged unless these are fully vetted through the base's approval process and designed following IFS.

15. When visual screening is necessary, consider landscaping as the first option; screen walls are permitted only in Group 1 finished with brick piers and medium bronze metal fencing.
16. For fencing, apply the standards for “Products, Materials and Color” in the following section. Limit those with the highest visual quality to Facility Group 1 where there is sustained maintenance. Define all levels of security and visual quality.
17. Do not use chain-link fencing at Group 1 or 2 facilities; Limit the use of barbed-wire outriggers on chain-link fencing at industrial sites, unless required for additional security or protection of assets.
18. Wood fencing may be used in Facility in recreation areas following IFS for material and finish when there is sustained periodic maintenance.
19. Provide trash dumpster enclosures for Group 1 with brick walls and metal gates to match adjacent facilities; Group 2 will use brick piers and metal screen walls; and Group 3 will use metal posts and screen walls; all metal screen walls and gates will be metal factory finished medium bronze.
20. Specify screen wall materials and finishes that do not require painting or maintenance beyond periodic cleaning.
21. Group 1, 2, 3 and recreational area picnic tables and seating will be vinyl clad or powder coated medium bronze. Recreational areas will have recycled plastic and metal bases for picnic tables and seating. Generally limit picnic tables, barbeque grills and drinking fountains to lodging, parks and recreation areas.
22. Limit the use of freestanding planters to areas with ongoing maintenance.
23. Provide kiosks only where there is a documented need for visual communication of posted messages. When used, match adjacent facilities in materials and detailing and consolidate kiosks with other site furnishings within 30 feet of major pedestrian paths. Limit kiosks to facility Groups 1 and 2 and parks.
24. Manufacturers listed below are only provided to establish a baseline of equivalency among all applicable manufacturers.

## **C07.2. Site Furnishings Products, Materials and Color**

**Note:** *Apply the below base-wide standards for Site Furnishings (products, materials and color). Then refer to the Appendix and apply any additional requirements specifically related to the Facility District in which the project is located.*



### C07.2.1. Barbeque Grills

Applicable  N/A

Number of base standards 2

Image Tool 250 x 188



Type: **Charcoal**

Applies to:  Group 1  Group 2  Group 3  Group 4  Other

Mfr: Most Dependable Fountains, Inc.

Color: Natural stainless steel

Finish: Mill

Model #: SS BBQ Grill

Other: Concrete foundation, coordinate with Base Architect

UFGS: N/A



Type: **Natural Gas**

Applies to:  Group 1  Group 2  Group 3  Group 4  Other

Mfr: BBQ Coach

Color: Natural stainless steel

Finish: Mill

Model #: 32" 4-Burner

Other: Built-in Concrete or masonry, coordinate with Base Architect

UFGS: N/A

**C07.2.2. Benches**

Applicable  N/A

Number of base standards 2

Image Tool 250 x 188



Type: **Metal Slatted**

Applies to:  Group 1  Group 2  Group 3  Group 4  Other

Mfr: Belson Outdoors

Color: Medium bronze to match adjacent

Finish: Factory powder coat

Model #: Model CBPB-6SB

Other: N/A

UFGS: N/A



Type: **Recycled Plastic**

Applies to:  Group 1  Group 2  Group 3  Group 4  Other

Mfr: The Park Catalog

Color: Slats: cedar or brown; black or matching base

Finish: Factory

Model #: 289-1106, 6ft Comfort Park Avenue Recycled Plastic Bench

Other: Limit use to lodging applications and park settings

UFGS:



### C07.2.3. Bike Racks

Applicable  N/A

Number of base standards 1

Image Tool 250 x 188



Type: **Style 1**

Applies to:  Group 1  Group 2  Group 3  Group 4  Other

Mfr: Brandir International Inc.

Color: Galvanized

Finish: Factory

Model #: The Ribbon Bike Rack, RB-07

Other: N/A

UFGS: N/A

### C07.2.4. Bike Lockers

Applicable  N/A

### C07.2.5. Bollards

Applicable  N/A

Number of base standards 3

Image Tool 250 x 188



Type: **Pop-Up Traffic Bollards**

Applies to:  Group 1  Group 2  Group 3  Group 4  Other

Mfr: Hercules

Color: Natural stainless steel

Finish: Factory mill finish

Model #: 8" diameter

Other: Coordinate Crash Rating with CES

UFGS: N/A



Type: **Lighted Round Flat Top - Aluminum**

Applies to:  Group 1  Group 2  Group 3  Group 4  Other

Mfr: Lithonia Lighting Products

Color: Medium bronze

Finish: Anodized aluminum

Model #: KBA

Other: Flared cone, 3000K LED Lamp; follow manufacturer's recommendations for fixture base

UFGS: N/A

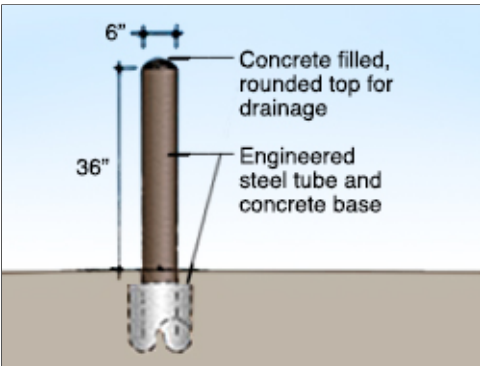

Type: **Building Protection, steel**

Applies to:  Group 1  Group 2  Group 3  Group 4  Other

Mfr: (Bollard Cover) Reliance Foundry

Color: Brown cover may be field painted medium bronze

Finish: Factory

Model #: 6" Steel pipe, concrete filled, Cover: R-7173

Other: A 1" (25.4 mm) rigid conduit and box with shroud may be provided at top of bollard with a receiver/key switch application

UFGS: N/A



### C07.2.6. Bus Shelters

Applicable  N/A

Number of base standards 1

Image Tool 250 x 188



Type: **1**

Applies to:  Group 1  Group 2  Group 3  Group 4  Other

Mfr: Custom

Color: Medium bronze

Finish: Powder coated

Model #: Dome roof

Other: Provide concrete slab and 1 pre-manufactured aluminum bench

UFGS: N/A

### C07.2.7. Drinking Fountains

Applicable  N/A

Number of base standards 1

Image Tool 250 x 188



Type: **Pedestal**

Applies to:  Group 1  Group 2  Group 3  Group 4  Other

Mfr: Most Dependable Fountains, Inc.

Color: Natural

Finish: Stainless steel

Model #: MDF 440 SMSS

Other: Accessible

UFGS: N/A

### C07.2.8. Dumpster Enclosures / Gates

Applicable  N/A

Number of base standards 1

Image Tool 250 x 188



Type: **1: Brick and Steel**

Applies to:  Group 1  Group 2  Group 3  Group 4  Other

Mfr: Custom

Color: Red brick blend, dark brown doors

Finish: Face brick, powder coated doors

Model #: Match adjacent building

Other: Steel gates and hardware, dark brown, dumpsters will be painted dark brown

UFGS: Section 04 20 00 Unit Masonry

### C07.2.9. Fencing

Applicable  N/A

Number of base standards 6

Image Tool 250 x 188



Type: **Style A Barrier: High Security, High Visibility**

Applies to:  Group 1  Group 2  Group 3  Group 4  Other

Mfr: Custom

Color: Medium bronze or black

Finish: Powder coated

Model #: Steel posts, rails and pickets (vertical, may be bent outward at top)

Other: N/A

UFGS: Section 05 50 13 Miscellaneous Metal Fabrications



Type: **Style B Barrier: High Security, Medium Visibility**

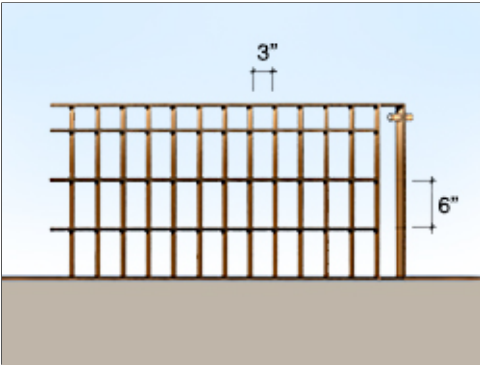

Applies to:  Group 1  Group 2  Group 3  Group 4  Other

Mfr: Custom

Color: Dark brown

Finish: Powder coat

Model #: Steel grid: flat bar stock verticals, round rod horizontals

Other: Steel posts, horizontal bars, braces, and accessories, in heights, lengths, and gauges as required; Close all ends of tubing

UFGS: Section 05 50 13 Miscellaneous Metal Fabrications

Type: **Style C Barrier: High Security, Low Visibility**

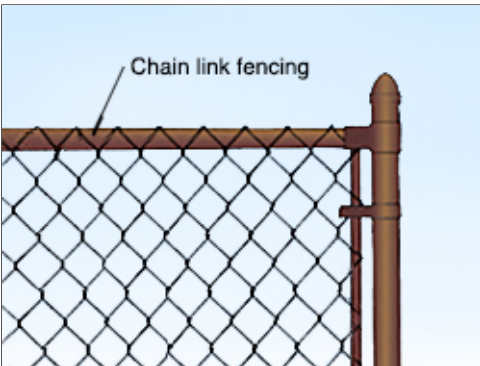

Applies to:  Group 1  Group 2  Group 3  Group 4  Other

Mfr: General Wire Company

Color: Medium bronze or galvanized

Finish: Powder coated galvanized steel or factory finish

Model #: Chain link, steel posts and rails, gates and accessories

Other: N/A

UFGS: Section 32 31 13 Chain Link Fences and Gates

Type: **Style D Barrier: Low Security, High Visibility**

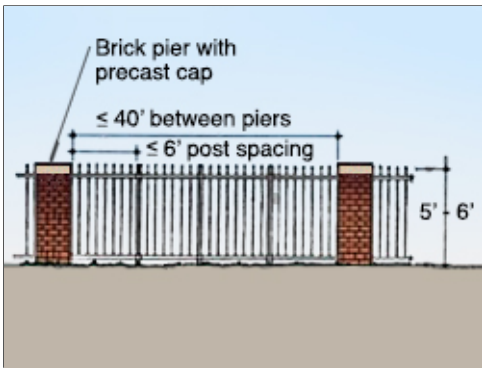

Applies to:  Group 1  Group 2  Group 3  Group 4  Other

Mfr: Custom

Color: Red brick blend, dark brown fencing

Finish: Face brick, powder coated metal

Model #: Brick Piers with steel posts, rails and pickets

Other: Brick: 2'x2' (Height as required, equally spaced 12' to 40'), Steel posts: 4"x4" (equally spaced), Rails: 2"x2", Pickets: 1"x1" (6" o.c.); close all ends of tubing

UGFS: Section 04 20 00 Unit Masonry, Section 05 50 13 Misc. Metal

Type: **Style E Barrier: Low Security, High Hisibility**

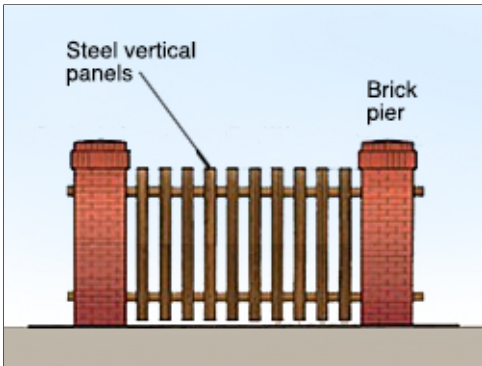

Applies to:  Group 1  Group 2  Group 3  Group 4  Other

Mfr: Custom

Color: Red brick blend, dark brown fencing

Finish: Powder coated metal

Model #: Brick Piers with steel posts, rails and alternating panels

Other: Brick: 2'x2' (Height as required, equally spaced 8' to 40'), Steel posts: 4"x4" (equally spaced), Rails: 1-1/4"x1-1/2", vertical steel panels spaced alternately on each side of the rails; matching gates; close all ends

UGFS: Section 04 20 00 Unit Masonry, Section 05 50 13 Misc. Metal



Type: **Style F Barrier: Very low security, high visibility**



Applies to:  Group 1  Group 2  Group 3  Group 4  Other

Mfr: Custom

Color: Integral mixed Davis Colors: dark warm gray

Finish: Factory

Model #: Post and rail

Other: Concrete 3-rail, wood-grain textured (4,000 psi at 28 days); Posts: 39" height, 8' spacing, set 30" deep below grade with footing, typical

UFGS: SECTION 03 33 00 Cast-In-Place Architectural Concrete

### C07.2.10. Flagpoles

Applicable  N/A

Number of base standards 1

Image Tool 250 x 188



Type: 1

Applies to:  Group 1  Group 2  Group 3  Group 4  Other

Mfr: Eder Flag

Color: Natural aluminum

Finish: Satin Lustre

Model #: ECL30 IH, Internal Halyard

Other: 5" Butt Dia. 33' H (30' Exposed)

UFGS: N/A

### C07.2.11. Lighting – Landscape / Accent

Please refer to the Lighting section.

### C07.2.12. Litter and Ash Receptacles

Applicable  N/A

Number of base standards 2

Image Tool 250 x 188



Type: **Style 1: Slatted Metal**

Applies to:  Group 1  Group 2  Group 3  Group 4  Other

Mfr: Belson Outdoors

Color: Medium bronze or black

Finish: Smooth

Model #: CBTR-FT

Other: Rigid plastic internal liner

UFGS: N/A

Type: **Style 2: Recycled Plastic Round Trash Receptacle**

Applies to:  Group 1  Group 2  Group 3  Group 4  Other

Mfr: Belson Outdoors

Color: Cedar tone slats, black lid

Finish: Factory

Model #: Urbanscape "E" with liner, 32 Gallon

Other: With dome top, without side door

UFGS: N/A

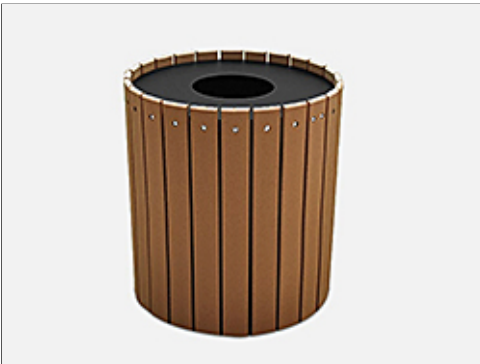



**C07.2.13. Picnic Tables**

Applicable  N/A

Number of base standards 2

Image Tool 250 x 188



Type: **Metal Rectangular Table with Recycled Top and Benches**

Applies to:  Group 1  Group 2  Group 3  Group 4  Other

Mfr: Belson Outdoors

Color: Wood tone top and bench, black frame

Finish: Recycled top and benches

Model #: Recycled content plank table with 2 benches

Other: N/A

UFGS: N/A



Type: **Metal Rectangular Table with Aluminum Top and Benches**

Applies to:  Group 1  Group 2  Group 3  Group 4  Other

Mfr: Belson Outdoors

Color: Anodized aluminum

Finish: Factory anodized top and benches, galvanized frame

Model #: Metal table with 2 benches

Other: N/A

UFGS: N/A

### C07.2.14. Planters

Applicable  N/A

Number of base standards 1

Image Tool 250 x 188

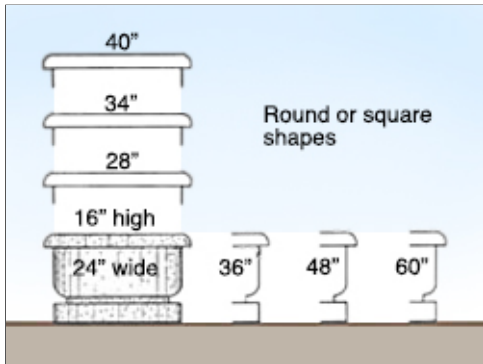

Type: **Precast concrete**

Applies to:  Group 1  Group 2  Group 3  Group 4  Other

Mfr: Materials, Inc.

Color: Weatherstone Gray

Finish: Smooth

Model #: Santa Fe

Other: N/A

UFGS: N/A

### C07.2.15. Play Equipment

Applicable  N/A

Number of base standards 1

Image Tool 250 x 188



Type: **Steel**

Applies to:  Group 1  Group 2  Group 3  Group 4  Other

Mfr: Little Tikes Commercial

Color: Varies

Finish: Powdercoated Steel

Model #: N-R-G Freestyle

Other: Coordinate with Base Architect

UFGS: N/A



### C07.2.16. Screen Walls

Applicable  N/A

Number of base standards 1

Image Tool 250 x 188

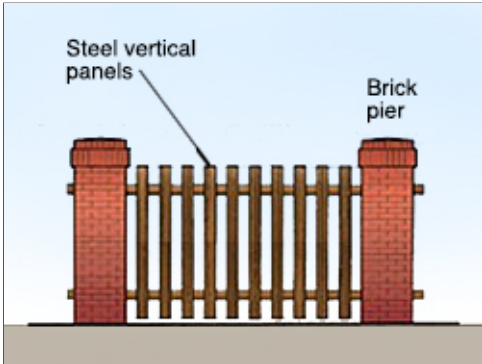

Type: **Brick / Steel**

Applies to:  Group 1  Group 2  Group 3  Group 4  Other

Mfr: Custom

Color: Red brick blend, dark brown fencing

Finish: Powder coated metal

Model #: Brick piers with steel posts, rails and alternating panels

Other: Brick: 2'x2' (height as required, equally spaced 8' to 40'), steel posts: 4"x4" (equally spaced), Rails: 1-1/4"x1-1/2", vertical steel panels spaced alternately on each side of the rails; matching gates; close all ends

UFGS: Section 04 20 00 Unit Masonry, Section 05 50 13 Misc. Metal

### C07.2.17. Tree Grates

Applicable  N/A

Number of base standards 1

Image Tool 250 x 188



Type: **Cast Iron**

Applies to:  Group 1  Group 2  Group 3  Group 4  Other

Mfr: Neenah Enterprises, Inc.

Color: Natural cast iron

Finish: Cast

Model #: 2-Piece, round or square

Other: N/A

UFGS: N/A

### C07.2.18. Other

Applicable  N/A

## C08. EXTERIOR SIGNS

Comply with AF Corporate Standards for Site Development:

<http://afcs.wbdg.org/site-development/index.html>

Comply with AF Corporate Standards for Exterior Signs:

<http://afcs.wbdg.org/site-development/exterior-signs/index.html>

### C08.1. Colors and Types

Applicable  N/A Select number of graphics / images (large: 800 px x 440 px) to insert 1

Image Tool 800 x 440

Applicable  N/A Select number of graphics / images (small: 250 px x 188 px) to insert 3

Image Tool 250 x 188



Standard Directional Sign



Approved Monument Sign at Group 1



Standard Building Identification Sign



Standard Traffic Device



1. Provide concise functional signs as a visually unifying element with consistent colors and types for all Installation and Gate Identification Signs; Building Identification Signs; Traffic Control Devices; Directional and Wayfinding Signs; and Informational and Motivational Signs.
2. Provide signs with the lowest overall life-cycle costs considering initial cost, ongoing maintenance and lifespan while meeting quality standards. Follow IFS for specifications appropriate for the local climate to withstand weathering.
3. Reduce the number of signs, reduce visual clutter and provide only essential signs required for identification, directions, instructions, and customer service following UFC 3-120-01. Remove non-conforming signs during renovation projects.
4. Use clear concise terms for content consistent with UFC 3-120-01.
5. Display of emblems on building exterior walls or other permanent structures is prohibited by UFC.
6. Raised "standout" letters and numbers may be used for Group 1 with approval on a case basis.
7. Group 2 and 3 facilities will have wall mounted facility signs with sizes and layouts following UFC 3-120-01.
8. Only one identification sign is permitted at each building entrance. Include a building address consistent with US Postal Service protocols following UFC 3-120-01.
9. Traffic Control Devices, which regulate vehicular traffic on the installation, will conform to the standards in the Manual of Uniform Traffic Control Devices (MUTCD) published by the Federal Highway Administration. Coordinate street signs with this IFS.
10. Provide Directional and Wayfinding Signs and address both pedestrian and vehicular traffic following UFC 3-120-01 for size, layout and content.
11. Reserved parking signs should be kept to a minimum. When approved, provide post-mounted sign faces in base standard materials and colors. Consider "bracketing" a designated area with a single sign at each end.
12. Parking lot identification signs may be used to identify areas or rows within large lots.
13. Follow the guidelines and requirements in ABAAS and the MUTCD for accessible parking signs.
14. Follow UFC 3-120-01 for Informational and Motivational Signs for size, layout and content.
15. Symbols or pictographs (graphic expressions of actual objects) may be used to indicate service, mandatory / prohibitory, sports, and recreation when rapid communication is necessary.
16. Force Protection signage may be applied to glass doors using white vinyl lettering.
17. Refer to UFC 3-120-01 for prohibited signs, which include those with animated, blinking, chasing, flashing, or moving effects.
18. Manufacturers listed below are only provided to establish a baseline of equivalency among all applicable manufacturers.

### **C08.1.1. Materials and Color Specifications**

Applicable  N/A Large graphics do not apply

Applicable  N/A Small graphics do not apply

1. Fabricate sign panels from aluminum sheeting with vinyl sign faces and lettering. Sign posts will be dark bronze anodized aluminum with capped ends in a concrete base.
2. Fence mounted sign panels may be attached with exposed fasteners.

3. All signage will follow Federal Highway Administration (FHWA) Manual on Uniform Traffic Control Devices (MUTCD) using standard colors. Refer to MUTCD color specifications, which provide cross-referenced Pantone Matching System (PMS) numbers.
  - a. Standard Blue
  - b. Standard Dark Bronze (also Federal Standard Color 30040)
  - c. Standard Red
  - d. Standard Black (non-reflective)
  - e. Standard White
  - f. Standard Brown

### Materials and Color Specifications

Applicable  N/A      Number of base standards 3

Image Tool 250 x 188



Type: **Typical Sign Fce**

Applies to:  Group 1  Group 2  Group 3  Group 4  Other

Mfr: Custom

Color: Medium bronze

Finish: Matte vinyl

Model #: Aluminum flat sheet

Other: Mount to square posts. Provide sizes following UFC.

UFGS: Section 05 50 13 Miscellaneous Metal Fabrications

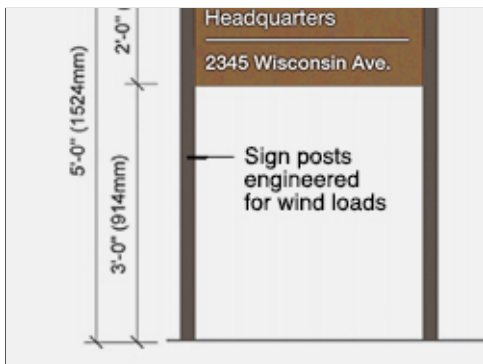

Type: **Typical Sign Post**

Applies to:  Group 1  Group 2  Group 3  Group 4  Other

Mfr: Custom

Color: Dark bronze, powder coat finish

Finish: Matte

Model #: Extruded aluminum with capped top ends

Other: Square posts and squared ends. Provide engineered sizes.

UFGS: Section 05 50 13 Miscellaneous Metal Fabrications



Type: **Typical Sign Base**

Applies to:  Group 1  Group 2  Group 3  Group 4  Other

Mfr: Custom

Color: Natural Gray

Finish: Sonotube-formed

Model #: 24" height x 12" diameter, as engineered.

Other: At grade with 3/4" chamfer. Provide engineered sizes.

UFGS: UFGS 03 30 00 Cast-in-place Concrete

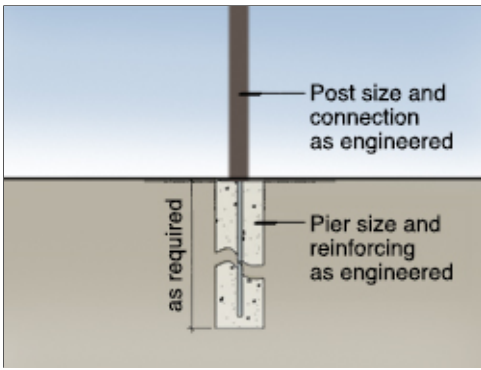

### C08.1.2. Installation and Gate Identification Signs

Applicable  N/A Number of base standards 1

Image Tool 250 x 188

Type: **Primary, Secondary and Tertiary (Uses per UFC)**

Applies to:  Group 1  Group 2  Group 3  Group 4  Other

Mfr: Custom

Color: Dark bronze, brushed aluminum, accents per UFC

Finish: Powder coat or vinyl sign face

Model #: Metal frame and panels, buff stone base

Other: White vinyl lettering. Provide dimensions per UFC. Secondary signs will match primary sign's materials, but will be smaller in size per UFC. Tertiary signs will follow the UFC.

UFGS: Section 05 50 13 Miscellaneous Metal Fabrications



### C08.1.3. Building Identification Signs

Applicable  N/A

Number of base standards 5

Image Tool 250 x 188

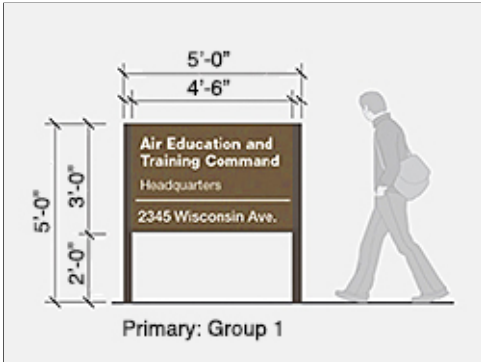

Type: **Freestanding Primary Sign (Sizes and Uses per UFC)**

Applies to:  Group 1  Group 2  Group 3  Group 4  Other

Mfr: Custom

Color: Medium brown face, dark bronze posts, white vinyl lettering

Finish: Powder coat or vinyl sign face

Model #: Aluminum sheet face, extruded aluminum posts

Other: Provide layout and sizes per UFC.

UFGS: Section 05 50 13 Miscellaneous Metal Fabrications

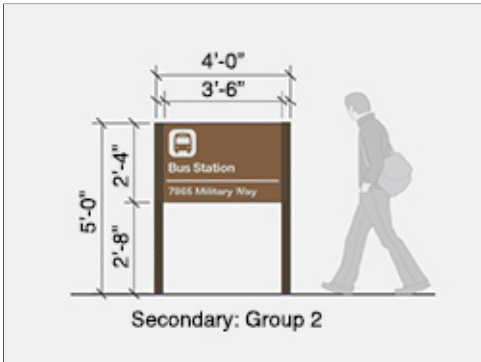

Type: **Freestanding Secondary Sign (Sizes and Uses per UFC)**

Applies to:  Group 1  Group 2  Group 3  Group 4  Other

Mfr: Custom

Color: Medium brown face, dark bronze posts, white vinyl lettering

Finish: Powder coat or vinyl sign face

Model #: Aluminum sheet face, extruded aluminum posts

Other: Provide layout and sizes per UFC.

UFGS: Section 05 50 13 Miscellaneous Metal Fabrications

Type: **Freestanding Tertiary Sign (Sizes and Uses per UFC)**

Applies to:  Group 1  Group 2  Group 3  Group 4  Other

Mfr: Custom

Color: Medium brown face, dark bronze posts, white vinyl lettering

Finish: Powder coat or vinyl sign face

Model #: Aluminum sheet face, extruded aluminum posts

Other: Provide layout and sizes per UFC.

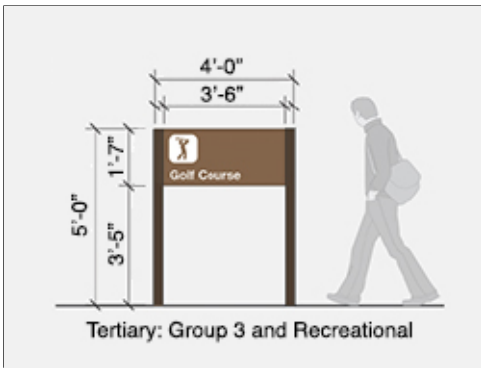

UFGS: Section 05 50 13 Miscellaneous Metal Fabrications

Type: **Wall Mounted**

Applies to:  Group 1  Group 2  Group 3  Group 4  Other

Mfr: Custom

Color: Medium brown, white lettering

Finish: Satin vinyl applied to aluminum sheet

Model #: Aluminum sheet with vinyl face and vinyl lettering

Other: Provide layout and sizes following UFC.

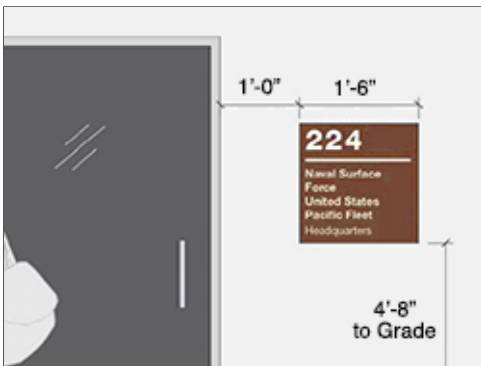

UFGS: N/A



Type: **Glass Mounted**



Applies to:  Group 1  Group 2  Group 3  Group 4  Other

Mfr: Custom

Color: White vinyl lettering

Finish: Matte vinyl

Model #: Machine-cut sheet vinyl

Other: Apply vinyl lettering to glass. Provide sizes following UFC.

UFGS: N/A

#### C08.1.4. Traffic Control Devices (Street Signs)

Applicable  N/A Number of base standards 1

Image Tool 250 x 188



Type: **Street Signs**

Applies to:  Group 1  Group 2  Group 3  Group 4  Other

Mfr: Custom

Color: White reflective lettering on a standard brown background

Finish: Powder coat or vinyl sign face

Model #: Aluminum sign face, control arm or pole mounted

Other: Mount 7' above grade minimum, pictographs and logos are prohibited on street name signs per UFC.

UFGS: Section 05 50 13 Miscellaneous Metal Fabrications

### C08.1.5. Directional and Wayfinding Signs

Applicable  N/A Number of base standards 2

Image Tool 250 x 188



Type: **Vehicular**

Applies to:  Group 1  Group 2  Group 3  Group 4  Other

Mfr: Custom

Color: Medium brown face, dark bronze posts, white reflective lettering

Finish: Powder coat or vinyl sign face

Model #: Aluminum sheet face, extruded aluminum posts

Other: Conform to the requirements of the MUTCD and its DoD Supplement. Provide types and sizes where required by UFC.

UFGS: Section 05 50 13 Miscellaneous Metal Fabrications

Type: **Pedestrian**

Applies to:  Group 1  Group 2  Group 3  Group 4  Other

Mfr: Custom

Color: Medium brown face, dark bronze posts

Finish: Powder coat or vinyl sign face

Model #: Aluminum sheet face, extruded aluminum posts

Other: White vinyl lettering. Provide types and sizes where required by UFC.

UFGS: Section 05 50 13 Miscellaneous Metal Fabrications

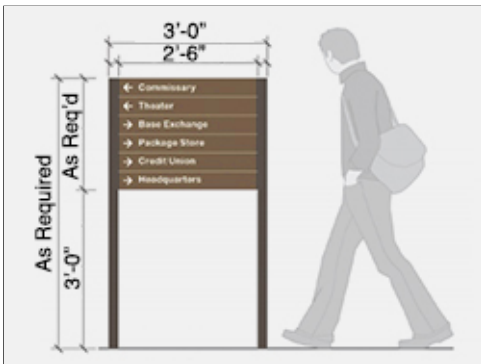

### C08.1.6. Informational Signs

Applicable  N/A Large graphics do not apply

Applicable  N/A Small graphics do not apply

1. Minimize informational signs such as static display signs, hours of operation, and project signs to reduce visual clutter.
2. Static display signs will have standard medium bronze.
3. Hours of operation signs will have a level of quality equivalent to the Facility Group number.

4. Temporary / Project Signage will be judiciously placed to avoid visual clutter. Schedule and arrange for the removal of these signs prior to installation.

### **C08.1.7. Motivational Signage**

- Applicable  N/A Large graphics do not apply
- Applicable  N/A Small graphics do not apply

1. Provide professionally produced motivational signs as important elements of campaigns to boost morale, improve safety, aid in recruiting, and accomplish other motivational objectives. Consolidate this signage to reduce visual clutter.
2. Motivational signs will be limited to an electronic "marquee" type changeable sign near each gate. Temporary signs are not permitted. Motivational information may also be posted in a small, printed format on kiosks in specified, high pedestrian use areas. Refer to kiosks under Site Furnishings.
3. Follow UFC 3-120-01 for color and layout. Note that animated, blinking, chasing, flashing, or moving effects are prohibited by the UFC.
4. Mount marquee signs on reinforced concrete bases with a natural warm gray color.

### **C08.1.8. Parking Lot Signs**

- Applicable  N/A

1. Follow UFC 3-120-01 and AFCFS.

### **C08.1.9. Regulatory Signs**

- Applicable  N/A

1. Regulatory signage, which restricts, warns and advises, will be limited to those mandated under Highway/Traffic, Government Warning, and/or Parking Regulation. Follow UFC 3-120-01 and its industry references for color and layout.
2. Provide a comprehensive, systematic approach to regulatory signage to avoid clutter and confusion from "over signage."
3. Maintain base warning signs for safety and security at the base perimeter and at specific secure areas. Use these to notify visitors of restrictions governing conduct on the base, as well as other security procedures.

### **C08.1.10. Other**

- Applicable  N/A



## C09. LIGHTING

Comply with AF Corporate Standards for Site Development:  
<http://afcs.wbdg.org/site-development/index.html>

Comply with AF Corporate Standards for Lighting:  
<http://afcs.wbdg.org/site-development/lighting/index.html>

### C09.1. Fixtures and Lamping

Applicable  N/A Large graphics do not apply

Applicable  N/A Select number of graphics / images (small: 250 px x 188 px) to insert 3

Image Tool 250 x 188



Single Mast LED



Double Mast LED



Bollard with LED Lighting

1. Provide, coordinate and efficiently install street, parking lot, sidewalk and facility lighting with appropriate luminaires, lamping, placement and spacing following UFC 3-530-01 and Installation Facilities Standards (IFS); ensure the level of quality is consistent with the adjacent facility group number. Pole-mounted, wall-mounted and bollard fixtures are permitted.
2. Integrate controls to automatically reduce lighting power during periods of non-activity; automatically turn off power when sufficient daylight is available.
3. Ensure continuity and consistency of lighting elements. In new construction generally match post types, fixture types, styles, heights, sizes, materials, colors, and lamp types of adjacent facilities and the facility district.
4. Economically provide renewable-energy power sources such as solar photovoltaic when feasible.
5. Use appropriately designed or shielded luminaires to direct light downward to minimize light pollution and intrusion onto adjacent sites and to facilitate night training.
6. Calculate illuminant levels for all lighting applications following UFC 3-530-01 and ensure compliance with pre-curfew maximum brightness level requirements.
7. Sufficiently address environmental factors to prevent corrosion and weathering of fixtures, plinths and other components.
8. Wall mounted fixtures should respond to the architectural character of the facility.
9. Efficient accent lighting of architectural and landscape features may be provided for Group 1, lodging and historical applications. Accent lights in ground-mounted locations may be provided for static displays and signs when these do not conflict or cause hazards with overhead aircraft.
10. Comply with UFC 3-530-01 for light source technology and lamp types. High efficiency lamping such as LED is preferred for most applications.

11. Provide round tapered, square non-tapered, or round non-tapered aluminum poles and aluminum fixtures with square, rectangular or circular housings in colors and shapes to match adjacent facilities and the facility district.
12. Install lighted bollards only at Group 1 and high-traffic Group 2 facilities. Generally match materials, colors and shapes of adjacent facilities and the facility district.
13. Install natural warm gray color, smooth finished concrete bases for all poles in heights appropriate for the facility group and application. Generally Groups 1 and 2 will have at-grade bases. Group 3 will have taller bases for added durability.
14. When parking lot lighting is necessary, provide an illuminated path to the building's main entrance. Pole bases should be contained within an internal landscape median or island.
15. Consistently install lighting for sidewalks, bikeways and trails to match adjacent facilities.
16. Landscape accent lighting may be used in public gathering spaces and in Group 1 facilities. Coordinate the design, luminaire selection, and placement with the location of trees, shrubs, and site furnishings.
17. Manufacturers listed below are only provided to establish a baseline of equivalency among all applicable manufacturers.

## C09.2. Light Fixture Types

**Note:** Apply the below base-wide standards for Light Fixtures (products, materials and color). Then refer to the Appendix and apply any additional requirements specifically related to the Facility District in which the project is located.

### C09.2.1. Street Lighting

Applicable  N/A

Number of base standards 1

Image Tool 250 x 188



Type: **LED Street**

Applies to:  Group 1  Group 2  Group 3  Group 4  Other

Mfr: Hubbell, Beacon Viper luminaire

Color: Dark bronze, gray or clear anodized aluminum as approved by BCE

Finish: Factory

Model #: VPL/ 80NB-180/4K/T3/UNV/GYS

Other: Lamp LED. Roadway – Poles will be 25' clear anodized, round tapered seamless aluminum with matching 8' up swept mounting arm, brushed aluminum finish. Pole will be rated for 100 MPH wind with a 1.3 factor

UFGS: N/A

## C09.2.2. Parking Lot Lighting

Applicable  N/A

Number of base standards 2

Image Tool 250 x 188



Type: **LED Parking Lot**

Applies to:  Group 1  Group 2  Group 3  Group 4  Other

Mfr: Hubbell, Beacon Viper luminaire

Color: Dark bronze or clear anodized as approved by BCE

Finish: Factory

Model #: Rectilinear Cutoff, Single Arm or Dual Arm Mount

Other: Lamp: LED. Parking Lot – Poles will be 25' square straight extruded aluminum, 5" cross section, with 6" matching mounting arm, dark bronze anodized finish. Pole will be rated for 100 MPH wind, 1.3 factor

UFGS: N/A

Type: **Parking Lot Fixture Base**

Applies to:  Group 1  Group 2  Group 3  Group 4  Other

Mfr: Custom

Color: Natural gray

Finish: Trowel

Model #: Form-cast, round

Other: N/A

UFGS: Section 03 33 00 Cast-In-Place Architectural Concrete

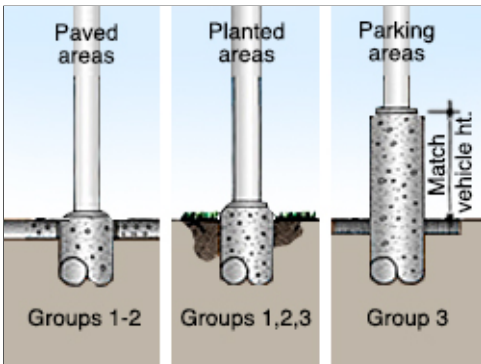



### C09.2.3. Lighted Bollards

Applicable  N/A

Number of base standards 1

Image Tool 250 x 188



Type: **Lighted Round Flat Top**

Applies to:  Group 1  Group 2  Group 3  Group 4  Other

Mfr: Lithonia Lighting Products

Color: Medium bronze

Finish: Anodized aluminum

Model #: KBA

Other: Flared cone, 3000K LED Lamp; follow manufacturer's recommendations for fixture base

UFGS: N/A

### C09.2.4. Sidewalk Lighting

Applicable  N/A

Number of base standards 1

Image Tool 250 x 188



Type: **LED Sidewalk, Direct**

Applies to:  Group 1  Group 2  Group 3  Group 4  Other

Mfr: Hubbell, Kim Lighting

Color: Dark bronze anodized (or clear anodized as approved by BCE)

Finish: Anodized aluminum

Model #: Rectilinear Cutoff, Single Arm or Dual Arm Mount

Other: Lamp: LED, follow manufacturer's recommendations for fixture base

UFGS: N/A

### C09.2.5. Walls / Stairs Lighting

Applicable  N/A

Number of base standards 1

Image Tool 250 x 188



Type: **Wall and Step Light**

Applies to:  Group 1  Group 2  Group 3  Group 4  Other

Mfr: Vista Lighting

Color: Dark bronze anodized

Finish: Smooth

Model #: Aluminum Step and Brick Lights, 5230 round louvered

Other: Lamp: LED

UFGS: N/A

### C09.2.6. Other

Applicable  N/A

## D. FACILITIES EXTERIORS

Comply with Air Force Corporate Standards for Facilities Exteriors:

<http://afcs.wbdg.org/facilities-exteriors/index.html>

Applicable  N/A Select number of graphics / images (large: 800 px x 440 px) to insert 1

Image Tool 800 x 440

Applicable  N/A Select number of graphics / images (small: 250 px x 188 px) to insert 3

Image Tool 250 x 188



Typical Palette of Materials for Group 3



Group 1 Materials



Group 3 Standard Metal Finishes and Color



Group 2 Materials and Detailing

### D01. SUPPORTING THE MISSION

Comply with AF Corporate Standards for Supporting the Mission:

<http://afcs.wbdg.org/facilities-exteriors/supporting-the-mission/index.html>

### D02. SUSTAINABILITY

Comply with Air Force Corporate Standards for Sustainability:

<http://afcs.wbdg.org/facilities-exteriors/supporting-the-mission/index.html>



### D03. ARCHITECTURAL FEATURES

Comply with AF Corporate Standards for Facilities Exteriors:

<http://afcfs.wbdg.org/facilities-exterior/index.html>

Comply with AF Corporate Standards for Architectural Features:

<http://afcfs.wbdg.org/facilities-exterior/architectural-features/index.html>

*Insert 3 photos for each facility group.*

Image Tool 250 x 188

Group 1



Group 2



Group 3



Group 4





### D03.1. Orientation, Massing and Scale

1. Orient new buildings to maximize energy efficiency, passive solar and daylighting potential of the building; narrow buildings oriented along an east-west axis are preferred to minimize heat gain in the summer months and maximize heat gain in the winter months resulting in less overall energy usage.

Applicable  N/A Select number of graphics / images (large: 800 px x 440 px) to insert 1

Image Tool 800 x 440

Applicable  N/A Select number of graphics / images (small: 250 px x 188 px) to insert 3

Image Tool 250 x 188



Massing and Scale Used to Reinforce Main Entrance Feature



Pedestrian Scale



Canopy Creating a Pedestrian Scale



Pedestrian Scaled Entrance Features

2. Provide orthogonal geometry for principal building form; angular geometry may be used sparingly for Group 1 and used only for emphasis at specific areas such as building entrances and stairwells.

3. Maintain a human scale and reduce the visual scale of large buildings with sub-massing related to interior functional operations; create consistent form and scale in adjacent buildings with compatible profiles or silhouettes.



4. Building heights will not be limited; however, building heights over 2 stories will be considered on a case basis.
5. Combine functions where practical to avoid a proliferation of small, independent structures.
6. Use and coordinate shading devices with orientation and for function.

**D03.2. Architectural Character**

1. Develop architectural features, materials and detailing appropriate for the Facility Group designation. Refer to Building Entrances, Wall Systems and Roof Systems.
2. Respond to the local climate and regional influences with environmentally functional architectural features.
3. For new facilities design generally maintain consistency and visual unity in the character of the adjacent buildings through compatible architectural features: repeated use of similar forms such as roofs, and through recurring elements such as doors, windows, materials and colors.
4. Reinforce the “Contemporary Vernacular” theme with architectural features expressive of innovation and technology that represents the current mission.
5. All facilities will express sustainability through their orientation, massing, shape, form, materials, and detailing. Provide roof overhangs, louvers, fins and other shading devices to control heat gain and glare and to and improve energy efficiency.
6. Strive for economical construction without compromising a high-quality, professional appearance.

Applicable    N/A   Select number of graphics / images (large: 800 px x 440 px) to insert   2

Image Tool 800 x 440

Applicable    N/A   Select number of graphics / images (small: 250 px x 188 px) to insert   3

Image Tool 250 x 188



Gabled Roof Form Used as a Unifying Feature





Recurring Used of Shed Roof Form



Flat Roofed Elements Defining Entrance



Hipped Roof Features



Massing and Shapes Defining Space

### D03.3. Details and Color

1. Provide a palette of earth-tone colors related to the native landscape in brick, block, stucco and powder-coated metals. Refer to D05. Wall Systems for detailed material listings.
2. Relate the level of architectural detailing to the Facility Group number.
3. Use only integrally colored materials as the predominant exterior building material; do not use materials that require field painting and ongoing maintenance.

Applicable  N/A Select number of graphics / images (large: 800 px x 440 px) to insert 1

Image Tool 800 x 440

Applicable  N/A Select number of graphics / images (small: 250 px x 188 px) to insert 3

Image Tool 250 x 188



Base Standard Colors



Predominant Use of Brick



Metal Sheeting Wall System



Brick with Stucco Accent

4. Provide consistent and compatible colors for every exterior building feature, including walls, roofs, doors, windows, gutters, downspouts, utility and mechanical elements, and other visible elements.
5. Noncorrosive metals with factory applied color finishes are required.
6. Combine details and color with orientation, massing, scale and architectural character to maintain station compatibility.
7. Manufacturers listed below are only provided to establish a baseline of equivalency among all applicable manufacturers.



### D03.3.1. Climate-based Data and Life-Cycle Cost-Effective Passive and Natural Design Strategies:

- Climate dominated by mechanical cooling
- Climate dominated by mechanical heating
- Climate with similar mechanical cooling / heating needs
- Climate with minimal mechanical cooling / heating needs
  
- Climate with high humidity
- Climate with moderate humidity
- Climate with low humidity
  
- High Solar Insolation
- Moderate Solar Insolation
- Low Solar Insolation
  
- Soils with High Thermal Conductivity
- Soils with Average Thermal Conductivity
- Soils with Low Thermal Conductivity

Other: Consider the potential for flooding and corrosion.

Other:

---

*Facility:* Narrow buildings along E-W axis are preferred

*Wall:* Integral shading features and devices / interior masonry thermal mass walls (for cooling)

*Doors:* Recessed are preferred

*Windows:* Provide insulating glazing on north-facing windows / maximize shading for windows on south façades

*Roof:* High to medium albedo, moderate slope for all buildings except hangars / large industrial facilities

*Structure:* Do not expose ferrous metals. Provide factory finished non-ferrous metals or concrete

*MEP:* Ground-source following LCCA

*Other:* Internal thermal mass walls may be used for cooling following LCCA.

*Other:*



**Note:** Apply the below base-wide standards for Architectural Features (products, materials and color). Then refer to the Appendix and apply any additional requirements specifically related to the Facility District in which the project is located.

### D03.3.2. Natural Ventilation System

Applicable  N/A

Number of base standards 1

Image Tool 250 x 188



Type: **Style 1 Aluminum Windows**

Applies to:  Group 1  Group 2  Group 3  Group 4  Other

Mfr: Kawneer (or equivalent)

Color: Dark Bronze (or clear anodized as approved by BCE)

Finish: Anodized

Model #: 2x4, slider or awning type

Other: Provide thermally broken frames.

UGFS: Section 08 41 13 Aluminum-Framed Entrances and Storefronts

### D03.3.3. Thermal Mass

Applicable  N/A

Number of base standards 1

Image Tool 250 x 188



Type: **Style 1 Interior Wall Material**

Applies to:  Group 1  Group 2  Group 3  Group 4  Other

Mfr: Custom, TBD

Color: Red brick blend

Finish: Light texture

Model #: Coursed unit masonry

Other: Brick is preferred. Concrete block may only be used in Group 3 when approved by the BCE.

UGFS: Section 04 20 00 Unit Masonry

### D03.3.4. Thermal Shading

Applicable  N/A

Number of base standards 1

Image Tool 250 x 188



Type: **Style 1 Wall Devices**

Applies to:  Group 1  Group 2  Group 3  Group 4  Other

Mfr: Kawneer (or equivalent) or custom

Color: Dark bronze

Finish: Factory, to match frames

Model #: Louver

Other: Shading devices may be attached to frames or structure

UFGS: Section 08 41 13 Aluminum-Framed Entrances and Storefronts

### D03.3.5. Renewable Heating/Cooling

Applicable  N/A

Number of base standards 1

Image Tool 250 x 188



Type: **Style 1 Geothermal (Ground Source)**

Applies to:  Group 1  Group 2  Group 3  Group 4  Other

Mfr: Climate Master

Color: N/A

Finish: N/A

Model #: N/A

Other: Vertical ground loop well field

UFGS: Section 23 81 47 Water-Loop and Ground-Loop Heat Pump Systems

### D03.3.6. Solar Photovoltaic System

Applicable  N/A

### **D03.3.7. Solar Thermal System**

Applicable  N/A



## D04. BUILDING ENTRANCES

Comply with AF Corporate Standards for Facilities Exteriors:

<http://afcfs.wbdg.org/facilities-exteriors/index.html>

Comply with AF Corporate Standards for Building Entrances:

<http://afcfs.wbdg.org/facilities-exteriors/building-entrances/index.html>

*Insert 3 photos for each facility group.*

Image Tool 250 x 188

Group 1



Group 2



Group 3



Group 4



### **D04.1. Primary Entrances**

1. Emphasize the primary entrance in the overall building design with a projecting or recessed covering for weather protection following Installation Facilities Standards (IFS) for Facility Group designations.
2. Provide vestibules at entries in Groups 1, 2 and 3 unless used infrequently or serving unconditioned space following ASHRAE 90.1.
3. Fully integrate all elements including the design of handicap ramps in the overall design of the primary entrance in an organized, uncluttered appearance.
4. Install paved transitional spaces sized for the building function and occupancy.
5. Install appropriate lighting and site furniture following AT and IFS.
6. Protect entrances from direct sun.
7. Provide porte cocheres or covered drop-offs when justified for lodging and medical facilities; do not use for prestige or architectural accents.

### **D04.2. Secondary Entrances**

1. Provide vestibules at entries in Groups 1, 2 and 3 unless used infrequently or serving unconditioned space following ASHRAE 90.1; use of stair towers as vestibules for multi-story buildings is encouraged when building and / or energy codes are satisfied.
2. Reflect the character of the primary entrance to a lesser extent with a smaller scale.
3. Include a recess or projection for weather protection and shading.
4. Integrate service and egress doors and loading areas with the building design by matching the materials and detailing and reflect the overall quality of the facility.
5. Incorporate egress structures such as stair towers into the facility design.
6. Canopies may be used for service and loading areas; weather protection beyond weatherstripping is not required at doors used only for life safety egress.
7. Develop building massing and orientation to minimize the appearance of service and loading areas; physically and visually separate these from primary entrances.
8. Loading areas must be organized, orderly and have an uncluttered appearance.



## D05. WALL SYSTEMS

Comply with AF Corporate Standards for Facilities Exteriors:

<http://afcs.wbdg.org/facilities-exteriors/index.html>

Comply with AF Corporate Standards for Wall Systems:

<http://afcs.wbdg.org/facilities-exteriors/wall-systems/index.html>

Comply with AFCFS Recommended Materials:

<http://afcs.wbdg.org/facilities-exteriors/wall-systems/materials/index.html>

*Insert 3 photos for each facility group.*

Image Tool 250 x 188

Group 1



Group 2



Group 3



Group 4





## **D05.1. Hierarchy of Materials**

1. Group 1 facilities may have more refined detailing than Group 2 and Group 2 may have more definition than Group 3.
2. Group 1 and 2 facilities will be a combination of red brick with belt course accents of red brick soldier courses or light beige or off-white architectural precast. Medium bronze metal panels may be used in Group 1 and 2 below eaves. Refer to Appendix F for special requirements of Facility Districts.
3. Architectural precast belt courses, water tables, window sills, and copings will use only 6,000 psi high-density architectural precast to resist weathering. Due to added costs for higher density, limit precast use only to Group 1 and 2 facilities. When budgets do not allow precast, metal copings and sills and metal panels may be used.
4. Natural sandstone belt course accents may be used only in Group 1 with BCE approval.
5. Multi-story Group 1 facilities may include a transition in material, color or detailing to create a visual base.
6. Brick Standards:
  - a. Use standard size face brick in a running band pattern with tooled concave joints.
  - b. Header, rowlock and soldier coursing with corbeling or other accents is encouraged.
  - c. "Youngstown Blend" brick, a mix of medium red brick and flash brick is the standard color.
  - d. Brick may be used when appropriate for lintels, soldier courses and sloped rowlock sills. Detailing should emulate bearing wall construction.
  - e. Conceal expansion joints with downspouts or locate these at transitions in the wall such as at pilasters or reveals.
  - f. Use natural Portland cement mortar.
  - g. Efflorescence in masonry work is unacceptable. Provide measures to prevent it.
7. Group 3 primary materials will be light neutral or beige insulated metal panels or ribbed metal sheeting. Where functionally required for durability, provide wainscots of brick. Refer to Appendix F for special requirements of Facility Districts.
8. Use high-performance building envelopes following UFC 1-200-02.
9. Use detailing not subject to excessive weathering. Provide wall accents consistently throughout the station.
10. Use integrally colored materials and factory-finished metals. Do not paint concrete block.
11. Translucent wall panels may be used in Facility Group 1 when protected from direct solar gain. Provide insulating panels and shading appropriate for the orientation and exposure.
12. Manufacturers listed below are only provided to establish a baseline of equivalency among all applicable manufacturers.

## **D05.2. Layout, Organization and Durability**

1. Organize wall components including doors, windows, accents, shading devices, control joints, etc., to provide an ordered, professional appearance.
2. Integrate shading devices into the overall composition of the wall.
3. Integrate fixed shading devices at all exterior glazing exposed to summer UV heat gain as a passive design measure to reduce energy use. Ensure adequate shading at west entrances. Deciduous trees may be used for shading.
4. Shading systems may be included as part of a manufacturer's window system or may be custom systems integrated into the wall.
5. Provide appropriate transitions between dissimilar materials to mitigate effects of thermal expansion and galvanic action per UFGS 07 60 00 Flashing and Sheet Metal.

6. All joint sealants will be slightly darker than adjacent surfaces.
7. Materials requiring regular maintenance are not permitted; do not use exposed structural steel or other materials that require painting.
8. Refer to C07.2.16. Screen Walls for materials and colors of freestanding walls.
9. Refer to D07. Roofs for downspouts.

**D05.3. Equipment, Vents and Devices**

1. Arrange all mechanical, electrical, fire alarm, lightning protection and other system components to create an orderly appearance that integrates with the wall system.
2. Do not expose conduits, cables, piping, lightning protection components, etc. on exterior walls; if unavoidable in renovations, finish these elements to match the adjacent wall surface.
3. Avoid visual clutter and where surface-mounted elements are required they will match the wall color.

**D05.4 Wall Systems Materials**

**Facility Group 1** wall materials shall be as follows.

- Primary: Brick
- Secondary: Architectural Precast, Alternate Brick Coursing
- Accent: Optional: Metal Panels

**Facility Group 2** wall materials shall be as follows.

- Primary: Brick
- Secondary: Architectural Precast, Alternate Brick Coursing
- Accent: Optional: Metal Panels

**Facility Group 3** wall materials shall be as follows.

- Primary: Insulated Metal Panels, Ribbed Metal Sheeting
- Secondary: Optional: Brick (in High Visibility Areas)
- Accent: Optional: Alternate Color of Metal

**Facility Group 4** wall materials shall be as follows.

- Primary: N/A
- Secondary: N/A
- Accent: N/A

**Note:** Apply the below base-wide standards for Wall Systems (products, materials and color). Then refer to the Appendix and apply any additional requirements specifically related to the Facility District in which the project is located.

## D05.4.1. Flat Metal Panels

Applicable  N/A

Number of base standards 3

Image Tool 250 x 188



Type: **Aluminum Composite Material Panel System**

Applies to:  Group 1  Group 2  Group 3  Group 4  Other

Mfr: 3A Composites

Model #: Alucobond Plus Anodized Collection

Color: Neutral colors, silver and warm gray

Finish: Clear anodized

Other: "V" route and return, vertical or horizontal expansion joints

UFGS: Section 07 42 13 Metal Wall Panels:

<http://www.wbdg.org/FFC/DOD/UFGS/UFGS 07 42 13.pdf>

Section 07 42 63 Fabricated Wall Panel Assemblies:

<http://www.wbdg.org/FFC/DOD/UFGS/UFGS 07 42 63.pdf>

Type: **Insulated Metal Panel System - Kynar Finish**

Applies to:  Group 1  Group 2  Group 3  Group 4  Other

Mfr: Metl-Span

Model #: CF Architectural Vertical Wall Panel, Flat Surface

Color: Medium bronze

Finish: Light texture, smooth

Other: N/A

UFGS: Section 07 42 13 Metal Wall Panels:

<http://www.wbdg.org/FFC/DOD/UFGS/UFGS 07 42 13.pdf>

Section 07 42 63 Fabricated Wall Panel Assemblies:

<http://www.wbdg.org/FFC/DOD/UFGS/UFGS 07 42 63.pdf>







Type: **Insulated Metal Panel System - Kynar Finish**

Applies to:  Group 1  Group 2  Group 3  Group 4  Other

Mfr: Metl-Span

Model #: CF Architectural Vertical Wall Panel

Color: Off-white or beige with BCE approval

Finish: Heavy stucco-embossed

Other: N/A

UFGS: Section 07 42 13 Metal Wall Panels:  
<http://www.wbdg.org/FFC/DOD/UFGS/UFGS 07 42 13.pdf>  
Section 07 42 63 Fabricated Wall Panel Assemblies:  
<http://www.wbdg.org/FFC/DOD/UFGS/UFGS 07 42 63.pdf>

#### D05.4.2. Brick Veneer

Applicable  N/A

Number of base standards 1

Image Tool 250 x 188

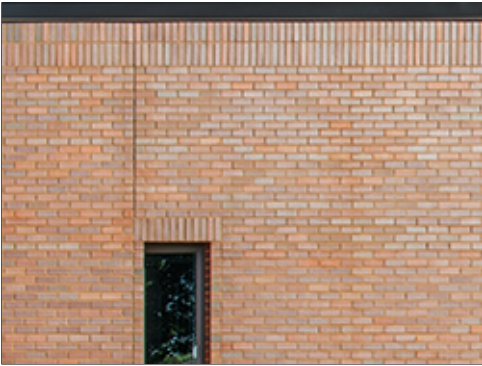

Type: **Modular Face Brick – Red with Flash Mix (Youngstown Blend)**

Applies to:  Group 1  Group 2  Group 3  Group 4  Other

Mfr: Local, TBD

Model #: Modular Face Brick, 2.3x4x8 nominal

Color: Red with Flash Youngstown Blend

Finish: Straight edges, smooth texture

Other: Flash brick intermixed to match adjacent

UFGS: Section 04 20 00 Unit Masonry:  
<http://www.wbdg.org/FFC/DOD/UFGS/UFGS 04 20 00.pdf>

### D05.4.3. Architectural Precast

Applicable  N/A

Number of base standards 2

Image Tool 250 x 188



Type: **Coursed Precast - Belt Courses, Lintels and Coping**

---

Applies to:  Group 1  Group 2  Group 3  Group 4  Other

Mfr: Local, TBD

---

Model #: Smooth casting, provide drip edge to prevent staining below surfaces

---

Color: Light beige

---

Finish: Very light texture

---

Other: Provide 6,000 psi density to prevent excessive weathering, drip edge

---

UFGS: Section 03 45 00 Precast Architectural Concrete:  
<http://www.wbdg.org/FFC/DOD/UFGS/UFGS 03 45 00.pdf>



Type: **Monolithic Precast Sill**

---

Applies to:  Group 1  Group 2  Group 3  Group 4  Other

Mfr: Local, TBD

---

Model #: Smooth casting

---

Color: Light beige or off-white

---

Finish: Very light texture

---

Other: Provide 6,000 psi density to prevent excessive weathering, drip edge

---

UFGS: Section 03 45 00 Precast Architectural Concrete:  
<http://www.wbdg.org/FFC/DOD/UFGS/UFGS 03 45 00.pdf>

#### D05.4.4. Stucco Over Sheathing

Applicable  N/A

Number of base standards 1

Image Tool 250 x 188



Type: **3-Coat Cementitious Stucco**

Applies to:  Group 1  Group 2  Group 3  Group 4  Other

Mfr: La Habra

Model #: Traditional 3-coat system

Color: Off-white, neutral colors, light beige

Finish: Sand

Other: Accent color may be used; stucco integrally colored

UFGS: Section 09 24 23 Cement Stucco:

[http://www.wbdg.org/FFC/DOD/UFGS/UFGS\\_09\\_24\\_23.pdf](http://www.wbdg.org/FFC/DOD/UFGS/UFGS_09_24_23.pdf)

#### D05.4.5. Curtain Wall

Applicable  N/A

Number of base standards 1

Image Tool 250 x 188



Type: **Pressure Equalized Rain Screen Design**

Applies to:  Group 1  Group 2  Group 3  Group 4  Other

Mfr: Kawneer

Model #: 7500 Wall, double glazing

Color: Silver frame, solar gray glazing

Finish: Kynar or anodized

Other: High thermal performance only

UFGS: Section 08 44 00 Curtain Wall and Glazed Assemblies:

[http://www.wbdg.org/FFC/DOD/UFGS/UFGS\\_08\\_44\\_00.pdf](http://www.wbdg.org/FFC/DOD/UFGS/UFGS_08_44_00.pdf)

#### D05.4.6. Cast-In-Place Concrete

Applicable  N/A

#### D05.4.7. Tilt-Up Concrete

Applicable  N/A



### D05.4.8. Ribbed Metal Sheeting

Applicable  N/A Number of base standards 2

Image Tool 250 x 188



Type: **Concealed Fastener – Large Scale Rib**

Applies to:  Group 1  Group 2  Group 3  Group 4  Other

Mfr: MBCI

Model #: 7.2 Panel

Color: Medium bronze as approved by Civil Engineer Squadron (CES)

Finish: Signature 300

Other: Minimum 24 gauge steel

UFGS: Section 07 42 13 Metal Wall Panels:  
<http://www.wbdg.org/FFC/DOD/UFGS/UFGS 07 42 13.pdf>

Type: **Exposed Fastener – Standard Rib**

Applies to:  Group 1  Group 2  Group 3  Group 4  Other

Mfr: Allied or equivalent

Model #: Standard Purlin Bearing Rib (PBR) panel with all closures

Color: Medium bronze

Finish: Factory standard, smooth

Other: 24 gauge steel; 36" wide, 12" o.c. rib spacing; exposed fastening system

UFGS: Section 07 42 13 Metal Wall Panels:  
<http://www.wbdg.org/FFC/DOD/UFGS/UFGS 07 42 13.pdf>

### D05.4.9. EIFS

Applicable  N/A

### D05.4.10. GFRC

Applicable  N/A

### D05.4.11. Concrete Block

Applicable  N/A

### D05.4.12. Fiber Cement Siding

Applicable  N/A

### D05.4.13. Other

Applicable  N/A

Number of base standards 2

Image Tool 250 x 188

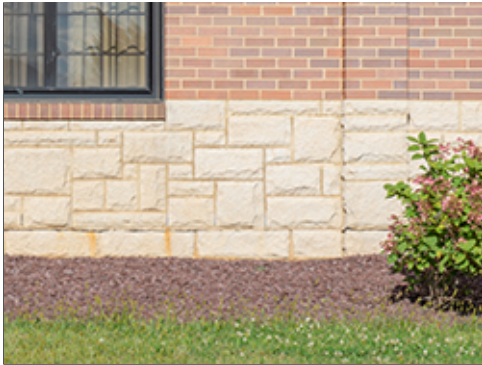

Type: **Coursed Ashlar Veneer Wall**

Applies to:  Group 1  Group 2  Group 3  Group 4  Other

Mfr: Local TBD

Model #: Coursed and dressed ashlar

Color: Off-white, light beige

Finish: Heavy textured face

Other: N/A

UFGS: SECTION 04 20 00 Unit Masonry



Type: **Coursed Ashlar Landscape Wall**

Applies to:  Group 1  Group 2  Group 3  Group 4  Other

Mfr: Local TBD

Model #: Coursed and dressed ashlar

Color: Off-white, light beige

Finish: Heavy textured face

Other: Snap-cut and chiseled face courses

UFGS: SECTION 04 20 00 Unit Masonry

## D06. DOORS AND WINDOWS

Comply with AF Corporate Standards for Facilities Exteriors:

<http://afcs.wbdg.org/facilities-exterior/index.html>

Comply with AF Corporate Standards for Doors and Windows:

<http://afcs.wbdg.org/facilities-exterior/doors-and-windows/index.html>

Comply with AFCFS Recommended Materials:

<http://afcs.wbdg.org/facilities-exterior/doors-and-windows/materials/index.html>

Insert 3 photos for each facility group.

Image Tool 250 x 188

Group 1



Group 2



Group 3

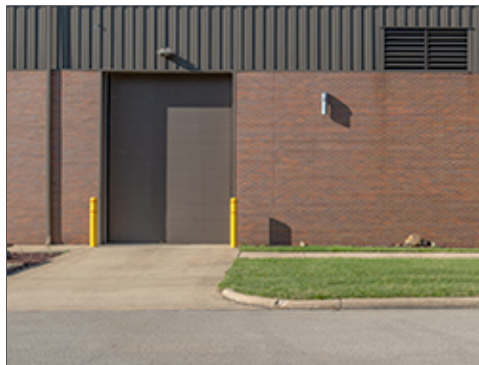

Group 4





### **D06.1. Types**

1. Clear anodized aluminum doors, windows and frames with thermal breaks are preferred for Facility Groups 1-3 because they show less wear and weathering than dark anodized finishes; match the color of the door and frame. For renovation projects the color of new windows, doors and frames may match existing.
2. Standard-sized hinged doors are preferred. Use sliding, folding, overhead, sectional and other door configurations only to support mission operations.
3. Automatic doors are allowed only where functionally necessary.
4. Limit hollow metal doors and frames to security doors, utility rooms and mechanical rooms in Groups 1 and 2 and to any application in Group 3 facilities.
5. Utility and emergency egress doors will match or be harmonious with the wall color.
6. Passive thermal comfort methods of ventilation are encouraged where life cycle cost justified.
7. Windows must meet force protection requirements.
8. Adjacent joint sealants should be slightly darker than the frame color.
9. Make efforts to contain noise at its source with properly gasketed doors per UFC 3-450-01 Noise and Vibration Control.
10. Manufacturers listed below are only provided to establish a baseline of equivalency among all applicable manufacturers.

### **D06.2. Layout and Geometry**

1. Visually and functionally compose openings in walls for the climate-specific exposure.
2. Consistently use opening type, size, placement, mullion pattern, and color to reinforce the overall architectural design.
3. Openings will augment interior lighting and space conditioning needs.
4. Protect against vandalism and intrusion.

### **D06.3. Glazing and Shading**

1. Tinted, energy-efficient, low-e, double-pane glazing is encouraged; provide triple-pane glazing in extreme environments.
2. Glazing color will be solar gray.
3. Translucent wall panels may be integrated into wall systems.
4. Do not use mirrored glazing.
5. Fully integrate applicable shading designs for overhangs, louvers, light shelves and grilles.
6. Where appropriate, install window screens to take advantage of natural ventilation.

### **D06.4. Hardware**

1. Provide hardware appropriate for the Facility Group while considering activity and frequency of use and local climate; hardware may be of higher visual quality for Facility Group 1.

2. Ensure hardware will perform throughout the facility's lifespan without showing extreme wear.
3. Select finishes that will not degrade by intensity of operation or exposure to the elements.
4. Use consistent finishes and color on window and door systems throughout a facility. For renovation projects the color of new hardware may match the existing hardware.
5. Design building systems to eliminate the need for security screens whenever possible.

## D06.5. Doors and Windows Materials

**Note:** Apply the below base-wide standards for Doors and Windows (products, materials and color). Then refer to the Appendix and apply any additional requirements specifically related to the Facility District in which the project is located.

### D06.5.1. Anodized Aluminum

Applicable  N/A      Number of base standards 1

Image Tool 250 x 188



Type: **Anodized Aluminum Doors, Windows and Frames**

Applies to:  Group 1  Group 2  Group 3  Group 4  Other

Mfr: Kawneer (or equivalent)

Color: Brown or clear anodized per CES

Finish: Matte

Model #: 2x4

Other: Provide thermally broken frames

UFGS: Section 08 41 13 Aluminum-Framed Entrances and Storefronts:  
<http://www.wbdg.org/FFC/DOD/UFGS/UFGS 08 41 13.pdf>

### D06.5.2. Hollow Metal

Applicable  N/A

Number of base standards 1

Image Tool 250 x 188



Type: **Hollow Metal Doors, Windows and Frames**

Applies to:  Group 1  Group 2  Group 3  Group 4  Other

Mfr: Steelcraft (or equivalent)

Color: Dark Brown

Finish: Powder Coated, Satin

Model #: 2x4 frame

Other: Provide thermally broken frames

UGFS: Section 08 11 13 Steel Doors and Frames:

<http://www.wbdg.org/FFC/DOD/UGFS/UGFS 08 11 13.pdf>

### D06.5.3. Aluminum-clad Wood

Applicable  N/A

### D06.5.4. Other

Applicable  N/A



## D07. ROOF SYSTEMS

Comply with AF Corporate Standards for Facilities Exteriors:

<http://afcs.wbdg.org/facilities-exteriors/index.html>

Comply with AF Corporate Standards for Roof Systems:

<http://afcs.wbdg.org/facilities-exteriors/roof-systems/index.html>

Comply with AFCFS Recommended Materials:

<http://afcs.wbdg.org/facilities-exteriors/roof-systems/materials/index.html>

*Insert 3 photos for each facility group.*

Image Tool 250 x 188

Group 1



Group 2



Group 3



Group 4



## **D07.1. Roof Type and Form**

1. Use proven, cost-effective roof systems with high durability, weather resistance, and low maintenance that are compatible with Installation Facilities Standards (IFS) and requirements for the designated Facility Group.
2. Generally match the roof type and form of existing adjacent facilities in new construction.
3. Group 1 and 2 buildings of simple geometry will use a sloped standing seam metal roof, with gabled ends and matching factory coated metal rakes. Group 1 and 2 buildings of complex geometry and large footprints will use a combination of sloped standing seam metal roofs and low sloped roofs.
4. Provide screens for roof-mounted appendages and equipment of the same materials, which are used predominantly in the building's roof systems.
5. Roof translucent panels are permitted only with BCE approval.
6. Group 2 and 3 facilities under 5,000 sf and narrow in plan geometry, may use low-sloped shed, gabled or hipped standing seam metal roofs. Larger facilities may use standing seam roof features in conjunction with predominantly low-slope mechanically seamed metal roofs.
7. Roof eaves will extend beyond the exterior wall for roof drainage and shading. Provide overhangs for shading in response to local climatic conditions; these should be sized and proportioned to the height of the facility and to the window openings being shaded.
8. South-facing eaves will coordinate with adjacent wall-mounted shading devices.
9. The color, shape and slope of the eave and soffit will be compatible with adjacent facilities.
10. Keep roofs uncluttered and minimize penetrations.
11. Diminish massive roofs into coordinated smaller components consistent with adjacent facilities; avoid random, arbitrary changes.
12. Increase the insulation value of existing roofing systems during renovations if supported by life-cycle cost and structural analysis.
13. Roofs will be maintained for the life of the system and replaced in accordance with UFC 3-110-04 and AFI 32-1051. A warranty is required on all new roofs.
14. Manufacturers listed below are only provided to establish a baseline of equivalency among all applicable manufacturers.

## **D07.2. Roof Slope**

1. Group 1 and 2 buildings will use sloped roofs, min. 3:12.
2. Low-sloped roofs are allowed for larger structures or to match existing conditions on renovation projects. Minimal-sloped roofs may also be used for Group 3 facilities in high-visibility areas.
3. Ensure adequate drainage and connect to the subsurface rain collection system where available.
4. Provide roof slopes to accommodate solar photovoltaic, solar thermal, passive systems and daylighting when applicable following UFC 1-200-02.
5. Provide underlayments as required for the roofing type as directed by the UFC.

## **D07.3. Parapets and Copings**

1. Parapets and copings are discouraged to avoid maintenance and roof leaks.

#### **D07.4. Color and Reflectivity**

1. Groups 1 and 2 and smaller facilities in Group 3 will be dark bronze to match adjacent facilities and follow requirements of IFS.
2. All minimal-slope membrane roofs will use only use high-albedo, high-reflectivity color to help decrease the temperature around the buildings and minimize damage to human and wildlife habitat.
3. Comply with UFC 3-110-03 and ASHRAE 90.1 for Solar Reflectance Index (SRI) and thermal requirements.
4. All roof flashing will match the color of the predominant background material.

#### **D07.5. Gutters, Downspouts, Scuppers, Drains**

1. All sloped roofs will use gutters and downspouts. Locate gutters outside the fascia.
2. Internal roof drainage systems are not permitted in new construction. Minimal-sloped roofs with parapets will be sloped to drain to the building perimeter through scuppers into downspouts.
3. All gutters and fascias will match the roof color.
4. Size the roof drainage system per IBC and SMACNA for the region.
5. Use scuppers as required in parapet walls. Arrange scuppers in an orderly manner consistent with other elements of the wall system.
6. When open scuppers are connected to downspouts, provide transitions consistent with adjacent facilities.
7. Integrate downspouts with the architectural details of the wall system and arrange in an orderly, non-prominent appearance. Generally blend downspouts with the color of the wall (not contrasting it).
8. Fabricate downspouts from non-corrosive materials such as aluminum or zinc-coated steel. Provide powder-coated finishes; on brick walls use medium bronze.
9. All downspouts will be solid.
10. Provide angled transitional pieces for downspouts to fit closely against the wall for their entire length.
11. Coordinate locations of downspouts to conceal control joints in masonry walls when possible.
12. Place downspouts away from building entries. Water discharged should not run across sidewalks.

#### **D07.6. Roof Vents and Elements**

1. Minimize and consolidate roof penetrations into a single, inconspicuous point whenever possible.
2. On sloped roofs clad pipe penetrations to match the roofing material.
3. Avoid the use of rooftop mechanical equipment; however, for renovations and unavoidable configurations, ensure units are screened.
4. Provide access points and service routes to equipment that protect the roof.



5. Screen all large vents.
6. Ensure attic spaces are properly vented at ridges and soffits.
7. Match roof color for all exposed equipment and vents.
8. Avoid roof-mounted antenna systems.
9. Arrange Lightning Protection Systems (LPS) components in an ordered, uncluttered and inconspicuous appearance; integrate components into the organization of the roof and wall systems.
10. Ensure that LPS roof mounting systems are approved by the roofing manufacturer.
11. Additions to a roof will not interfere with LPS or other rooftop systems that may be required.
12. Include permanent fall protection with any addition to a roof with a slope above 3:12 per UFC 3-110-03.

### **D07.7. Clerestories and Skylights**

1. Clerestories are permitted in Group 1 facilities. These are allowed in Group 3 facilities only when serving passive systems and are justifiable by life-cycle analysis.
2. Clerestories are preferred to skylights to avoid roof penetrations. Skylights are not permitted.
3. Design clerestories using the same principles for seasonal shading that are required for walls and roof overhangs.
4. Translucent panel systems are preferred in clerestory applications due to lack of window cleaning.
5. Clerestories must comply with UFC 4-10-01.

### **D07.8. Vegetated Roof**

1. Vegetated roofs are permitted on a case-by-case basis and must be approved by the BCE.

### **D07.9. Roof Systems Materials**

**Note:** *Apply the below base-wide standards for Roof Systems (products, materials and color). Then refer to the Appendix and apply any additional requirements specifically related to the Facility District in which the project is located.*

### D07.9.1. Standing Seam Metal

Applicable  N/A

Number of base standards 1

Image Tool 250 x 188



Type: **Low to Moderate Sloped Roofs**

Applies to:  Group 1  Group 2  Group 3  Group 4  Other

Mfr: Berridge

Color: Medium bronze

Finish: Matte

Model #: Tee-Panel

Other: Shed, gabled or hipped standing seam metal

UFGS: Section 07 61 14 Steel Standing Seam Roofing  
<http://www.wbdg.org/FFC/DOD/UFGS/UFGS 07 61 14.00 20.pdf>

### D07.9.2. Membrane Single-ply

Applicable  N/A

Number of base standards 1

Image Tool 250 x 188



Type: **EPDM Minimal Sloped Roofs**

Applies to:  Group 1  Group 2  Group 3  Group 4  Other

Mfr: Carlisle Syntec Systems

Color: Off-white

Finish: Smooth

Model #: Single-ply, "flat" minimal slope

Other: EPDM preferred

UFGS: Section 07 53 23 Ethylene-Propylene-Diene-Monomer Roofing  
<http://www.wbdg.org/FFC/DOD/UFGS/UFGS 07 53 23.pdf>  
Section 07 54 50 TPO Thermoplastic Single-Ply Roofing  
(Not Available on UFGS)

### D07.9.3. Built-up Multi-ply

Applicable  N/A

#### D07.9.4. Concrete Tile

Applicable  N/A

---

#### D07.9.5. Clay Tile

Applicable  N/A

---

#### D07.9.6. Slate Shingles

Applicable  N/A

---

#### D07.9.7. Vegetated System

Applicable  N/A

---

#### D07.9.8. Ribbed Metal Sheetting

Applicable  N/A      Number of base standards 1

Image Tool 250 x 188

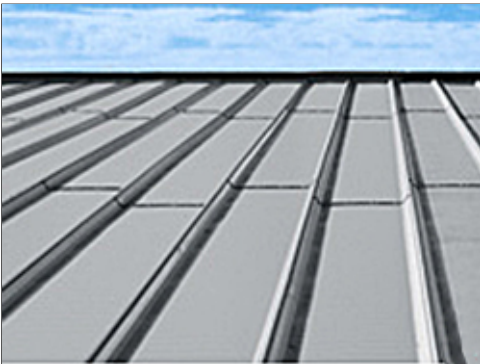

Type: **Style 1**

Applies to:  Group 1  Group 2  Group 3  Group 4  Other

Mfr: Berridge

Color: Galvalume

Finish: Factory

Model #: High Seam Tee-Panel

Other: 24 gauge steel, Width: 16" Batten height: 1-3/4"

UFGS: Section 07 41 13.19 Batten-Seam Metal Roof Panels  
(Not Available on UFGS)

---

#### D07.9.9. Composite Shingles

Applicable  N/A

---

#### D07.9.10. Other

Applicable  N/A

---



## D08. STRUCTURAL SYSTEMS

Comply with AF Corporate Standards for Facilities Exteriors:

<http://afcs.wbdg.org/facilities-exteriors/index.html>

Comply with AF Corporate Standards for Structural Systems:

<http://afcs.wbdg.org/facilities-exteriors/structural-systems/index.html>

Comply with AFCFS Recommended Materials:

<http://afcs.wbdg.org/facilities-exteriors/structural-systems/materials/index.html>

Insert 3 photos for each facility group.

Image Tool 250 x 188

Group 1



Group 2



Group 3



Group 4



## D08.1. Systems and Layouts

1. Pre-engineered structural steel framing may be used for Groups 1, 2 and 3 facilities; Installation-appropriate thermal envelopes, materials and detailing are required.
2. Select economical structural systems that integrate roof and wall systems.
3. Narrow buildings 60' or less in width with column-free interiors are preferred for office, administrative and personnel spaces; when interior columns are required optimize the structural grid layout for open-plan arrangements.
4. Fully coordinate structural grids with exterior window systems to align columns with window frames or wall systems.
5. When structure is exposed provide an organized appearance and coordinate with mechanical, electrical, plumbing, fire protection, information technology, and communications systems.
6. Limit the use of specialty systems (such as space frames, vaults or domes) and of structure as a visual feature.
7. Cost-effectively design interior bearing walls as thermal mass.
8. Manufacturers listed below are only provided to establish a baseline of equivalency among all applicable manufacturers.

## D08.2. Structural Systems Materials

**Note:** Apply the below base-wide standards for Structural Systems (products, materials and color). Then refer to the Appendix and apply any additional requirements specifically related to the Facility District in which the project is located.

### D08.2.1. Concrete

Applicable  N/A

Number of base standards 1

Image Tool 250 x 188



Type: **Cast-In-Place**

Applies to:  Group 1  Group 2  Group 3  Group 4  Other

Mfr: Custom

Color: Natural gray

Finish: Light texture

Model #: Post and beam and/or waffle slab

Other: N/A

UFGS: Section 03 30 53 Miscellaneous Cast-In-Place Concrete  
<http://www.wbdg.org/FFC/DOD/UFGS/UFGS 03 30 53.pdf>  
Section 03 33 00 Cast-In-Place Architectural Concrete  
<http://www.wbdg.org/FFC/DOD/UFGS/UFGS 03 33 00.pdf>  
Section 03 47 13 Tilt-Up Concrete  
<http://www.wbdg.org/FFC/DOD/UFGS/UFGS 03 47 13.pdf>

### D08.2.2. Insulated Concrete Forming (ICF)

Applicable  N/A

### D08.2.3. Steel

Applicable  N/A

Number of base standards 1

Image Tool 250 x 188



Type: **Rigid Framing**

Applies to:  Group 1  Group 2  Group 3  Group 4  Other

Mfr: US Steel

Color: Shop primed

Finish: Matte

Model #: Structural steel shapes

Other: N/A

UFGS: Section 05 12 00 Structural Steel

<http://www.wbdg.org/FFC/DOD/UFGS/UFGS 05 12 00.pdf>

### D08.2.4. Pre-Engineered Steel

Applicable  N/A

Number of base standards 1

Image Tool 250 x 188



Type: **Moment Frame**

Applies to:  Group 1  Group 2  Group 3  Group 4  Other

Mfr: Behlen Building Systems

Color: Factory primed

Finish: Matte

Model #: Moment Frame

Other: Draped insulation may be used behind wall system;  
Behlen standing seam roof system may be used for Group 3

UFGS: Section 13 12 00 Steel Building Systems

(Not Available on UFGS)

Section 13 34 19 Metal Building Systems

<http://www.wbdg.org/FFC/DOD/UFGS/UFGS 13 34 19.pdf>



### D08.2.5. Masonry

Applicable  N/A

---

### D08.2.6. Heavy Timber

Applicable  N/A

---

### D08.2.7. Light-gauge Steel

Applicable  N/A      Number of base standards 1

Image Tool 250 x 188



Type: **Steel Framing**

Applies to:  Group 1  Group 2  Group 3  Group 4  Other

Mfr: Steelrite

Color: Factory

Finish: Galvanized

Model #: Structural framing shapes

Other: N/A

UFGS: Section 05 45 00 Light Gauge Steel Framing System  
(Not Available on UFGS)

---

### D08.2.8. Lumber Framing

Applicable  N/A

---

### D08.2.9. Other

Applicable  N/A

---

## D09. MECHANICAL, ELECTRICAL AND PLUMBING

Comply with AF Corporate Standards for Facilities Exteriors:

<http://afcs.wbdg.org/facilities-exteriors/index.html>

Comply with AF Corporate Standards for Mechanical, Electrical and Plumbing:

<http://afcs.wbdg.org/facilities-exteriors/mechanical-electrical-and-plumbing/index.html>

Insert 3 photos for each facility group.

Image Tool 250 x 188

Group 1



Group 2



Group 3



Group 4



### **D09.1. Passive and Active Systems**

1. Fully integrate passive heating and cooling systems into facility designs whenever practical for the local climate prior to the design of active mechanical systems.
2. Provide optimized passive and active systems; design active mechanical systems to supplement thermal mass walls and floors.
3. Develop renewable-energy systems including geo-exchange (ground source heat pumps) when life cycle cost effective.
4. Performance display screens, which report energy performance and utility savings, are encouraged; when provided locate these in building lobbies or common areas.
5. Solar domestic hot water systems are required when life-cycle cost effective for the climate.
6. Integrate shading into building exteriors to reduce solar heat gain during hot seasons.

### **D09.2. Functionality and Efficiency**

1. Fully coordinate mechanical, electrical, plumbing (MEP) and fire protection systems with each other and with the building structure, enclosure, thermal envelope and interior design.
2. Ensure direct exterior access is provided (for CES) to main mechanical and electrical rooms.
3. Screen exterior equipment from primary views (landscape, building masses, screen walls) and comply with AT requirements.
4. Keep equipment away from main building entrances; locate service area/yard on least visible side of a building.
5. Coordinate the location of all exterior meters, equipment and devices to provide convenient access and an overall coordinated and orderly appearance.
6. Design emergency generator systems integrally with all other building systems and avoid incompatible building additions; locate generators near service areas and ensure they are not visible from primary entrances.
7. When structure is exposed as a finished ceiling, fully integrate MEP and fire protection systems to provide an organized, uncluttered appearance.
8. Conceal ducts, piping, conduits, devices, etc., when permanent walls, suspended ceilings or raised floors are provided; locate sprinkler heads in orderly configuration.
9. Limit interior wall-mounted equipment in occupied personnel spaces; avoid surface-mounted conduit and pipes.
10. Provide efficient utility rooms with layouts to facilitate system performance and maintenance; provide convenient access to controls, clearly label systems and include operating and maintenance instructions.
11. Separate mechanical and electrical and communications rooms.
12. Integrate recessed and wall-mounted fixtures such as fire standpipe cabinets and drinking fountains within permanent walls.



## E. FACILITIES INTERIORS

Comply with Air Force Corporate Standards for Facilities Interiors:  
<http://afcs.wbdg.org/facilities-interiors/index.html>

Insert 3 photos for each facility group.

Image Tool 250 x 188

Group 1

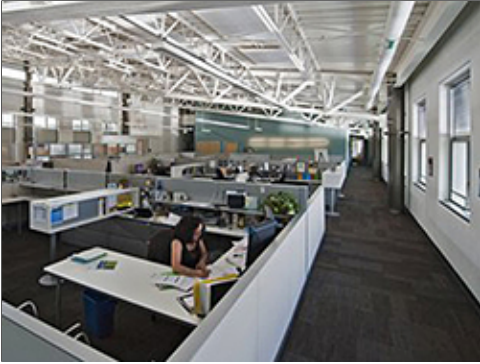

Group 2

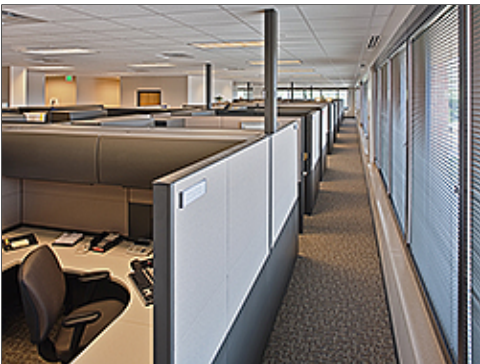

Group 3



Group 4



## **E01. Building Configurations**

Comply with Air Force Corporate Standards for Building Configurations:

<http://afcfs.wbdg.org/facilities-interiors/buildings-configurations/index.html>

1. Provide open-plan configurations for office, administrative, operational and related activities and spaces for maximum flexibility. Use a “core and shell” approach in which all building systems, infrastructure and permanent interior partitions anticipate two or more uses (operations) during a facility’s life span.
2. Create flexible interior configurations using Furniture, Fixtures & Equipment (FF&E) and limit private offices and private rooms. Refer to AFMAN 32-1084 for space requirements. To the greatest extent, limit permanent partitions to core areas such as toilet rooms, stairs, mechanical and utility rooms.
3. Use more durable long-lasting finishes in core areas for walls, ceilings, floor coverings and built-in casework. Coordinate interior FF&E layouts with structural grids during space planning.
4. Provide high-performance building configurations following UFC 1-200-02. Ensure passive design strategies are cost effectively incorporated before active mechanical systems are designed.
5. Comply with UFC 1-200-01, general building requirements. UFC 1-200-01 provides applicability of model building codes and government unique criteria for typical design disciplines and building systems, as well as for accessibility, antiterrorism, security, high performance and sustainability requirements, and safety.
6. Meet security and force protection requirements in UFC 4-010-01: DoD Minimum Antiterrorism Standards for Buildings.
7. Comply with AFCFS for supporting mission requirements, addressing human comfort and well being, and creating highly flexible interiors while satisfying metrics for high performance and sustainable buildings.
8. Provide a level of quality for interior features, materials and finishes that is appropriate for the Facility Group number. Group 1 may receive higher quality than Groups 2 thru 4. Refer to Facility Hierarchy.
9. Through open-plan configurations, preserve all passive and natural design strategies and fully integrate facility interiors with overall building systems.
10. Professional interior designers, or architects with significant interior design experience, must accomplish the design and review of applicable new construction, renovations and maintenance projects.
11. Consult with the State Historic Preservation Officer (SHPO) and base-level Historic Preservation offices regarding proposed changes to properties listed on or eligible for listing on the National Register of Historic Places. Follow requirements of The National Historic Preservation Act and Secretary of the Interior Standards for the Treatment of Historic Properties.
12. Maintain architectural compatibility following AFCFS and this Installation Facilities Standards (IFS) document to create continuity while avoiding monotony.

### **E01.1. Layout and Common Areas**

Comply with Air Force Corporate Standards for Layout and Common Areas:

<http://afcfs.wbdg.org/facilities-interiors/buildings-configurations/layout-and-common-areas/index.html>

1. Create open-plan interior environments to accommodate changes.
2. Limit interior partitions, private offices and rooms; use furniture or modular systems to provide privacy and acoustic control.
3. When partitions are functionally justified such as for conference rooms, use systems furniture and moveable (demountable) floor-to-ceiling wall systems for acoustical or visual privacy.
4. Proportion lobbies and common spaces based on type of function, activity and facility group.
5. Allow no direct sight lines into restrooms.

6. Situate utility and core areas to minimize impact on daylighting and to maximize use as thermal buffers.
7. Ensure electrical, lighting and communications system can be adaptable to configuration changes.
8. Avoid power poles to the maximum extent; when poles are necessary minimize the number and coordinate locations with furniture placement and other elements.
9. Avoid sloping floors to maintain flexibility and eliminate future structural changes.
10. Special consideration may apply to Sensitive Compartmented Information Facilities (SCIFs).

### **E01.1.1. Interior Design Process**

1. Comply with UFC 3-120-10 for the Comprehensive Interior Design (CID,) which includes both Structural Interior Design (SID) and Furniture, Fixtures & Equipment (FF&E) design services.
2. Use a collaborative, integrated planning and design team, composed of user, government support staff, and appropriate professionals. Integrate architectural features using simple detailing to create a professional appearance; avoid extravagant or excessive detailing.
3. Ensure interior designs satisfy the functional requirements within the context of flexibility, sustainability and the building's energy performance.
4. Base space planning on square foot allocations from AFM 32-1084. Identify special requirements if any, such as privacy separation, VIP areas, gathering spaces and storage. Note: The occupant's rank and position will influence the square footage and selection of materials.
5. Provide clear circulation and pathway finding for both horizontal and vertical directions that accommodate the number of personnel in the facility.
6. Maximize efficiencies in the space plan for functional relationships and adjacencies for all facility users. Efficiently create and situate rooms and support rooms such as conference / meeting rooms and break rooms.
7. Provide interior design building-related illustrations, drawings, schedules, materials selections, specifications and cost estimates as listed in UFC 3-120-10. Refer to Furnishings in this IFS also.
8. SID Format will follow UFC 3-120-10.
9. Base the FF&E package on the furniture footprint developed in the SID. Identify all new or existing equipment needed and its users within each facility or each area of the facility. Provide specific information on: equipment sizes, electrical requirements, ventilation requirements, weight (if heavy), quantity, and security level if required. Presume all administrative spaces have computers and supporting equipment.

### **E01.1.2. Codes and Regulations**

1. Refer to UFC 1-200-01 for modifications to the International Building Code (IBC) to determine applicable sections of the IBC. Both the IBC Chapter 3 and UFC 3-600-01 govern "Use and Occupancy Classification" for example.
2. Fire code requirements will be as defined in the International Building Code (IBC) and must be used where dictated by UFC 1-200-01 DoD Building Code (General Building Requirements) except where noted in UFC 3-600-01 (Fire Protection Engineering For Facilities).
3. National Fire Protection Association (NFPA) 101 must be utilized to determine the occupancy classification as it relates to fire/ smoke resistance rating of interior non-load bearing partitions (other than occupancy separation), means of egress, interior finish, features of fire protection (including vertical openings) and associated requirements.



## E01.2. Quality and Comfort

Comply with Air Force Corporate Standards for Quality and Comfort:

<http://afcs.wbdg.org/facilities-interiors/buildings-configurations/quality-and-comfort/index.html>

1. Include durability in the life-cycle cost analysis for best-value material selections with long life expectancies that do not show excessive wearing.
2. Select long-lasting materials and finishes for permanent core areas such as lobbies, restrooms and stairs.
3. Select low-maintenance materials and products that reduce ongoing servicing and repair and that are easy to clean.
4. Relate the visual quality of finishes to the Facility Group number.
5. Building and interior configurations should address both operations and climatic responses.
6. Convey a professional image; avoid trendy patterns and textures.
7. Use materials and finishes that provide a healthy indoor environment.
8. Orient interior spaces toward views while maintaining cost-effective building performance and efficiency.
9. Promote air movement and daylighting for human health and wellbeing.

## E02. Floors

Comply with Air Force Corporate Standards for Floors:

<http://afcs.wbdg.org/facilities-interiors/floors/index.html>

### E02.1. Floor Materials

**Facility Group 1** floor materials shall be as follows.

Primary: Prepared Slabs (Ground, Polished)  
Secondary: Porcelain tile  
Tertiary: Carpet, Rubber Stair Treads

**Facility Group 2** floor materials shall be as follows.

Primary: Prepared Slabs (Ground, Polished)  
Secondary: Ceramic tile  
Tertiary: Carpet, Rubber Stair Treads

**Facility Group 3** floor materials shall be as follows.

Primary: Prepared Slabs (Ground)  
Secondary: Prepared Slabs (Sealer)  
Tertiary: N/A

**Facility Group 4** floor materials shall be as follows.

Primary: N/A  
Secondary: N/A  
Tertiary: N/A

1. Natural stone and terrazzo flooring may be used in high traffic areas of Group 1 as approved on a case basis.
2. Resilient and rapidly renewable flooring may be used in low traffic areas in Group 1 and 2.
3. Manufacturers listed below are only provided to establish a baseline of equivalency among all applicable manufacturers.

**Note:** Apply the below base-wide standards for Floors (products, materials and color). Then refer to the Appendix and apply any additional requirements specifically related to the Facility District in which the project is located.

### E02.1.1. Prepared Slabs

Applicable  N/A      Number of base standards 2

Image Tool 250 x 188



Type: **Style 1, Ground and Polished**

Applies to:  Group 1  Group 2  Group 3  Group 4  Other

Mfr: Local (TBD)

Color: Natural gray cement, light to dark beige aggregates

Finish: Fine polished texture

Model #: Medium to small aggregate

Other: N/A

UFGS: Section 03 35 45 Polished Concrete Finishing  
(Not Available on UFGS)

Type:

Applies to:  Group 1  Group 2  Group 3  Group 4  Other

Mfr: Local (TBD)

Color: Natural gray cement, light to dark beige aggregates

Finish: Medium polished texture, slip resistant

Model #: Medium to small aggregate

Other: N/A

UFGS: Section 03 35 45 Polished Concrete Finishing  
(Not Available on UFGS)



### E02.1.2. Natural Stone and Terrazzo

Applicable  N/A

### E02.1.3. Quarry Tile

Applicable  N/A

Number of base standards 1

Image Tool 250 x 188



Type: **Style 1**

Applies to:  Group 1  Group 2  Group 3  Group 4  Other

Mfr: Daltille

Color: Earth tones

Finish: Matte, slip resistant

Model #: N/A

Other: Use in commercial kitchen flooring.

UFGS: Section 09 30 10 Ceramic, Quarry, and Glass Tiling  
<http://www.wbdg.org/FFC/DOD/UFGS/UFGS 09 30 10.pdf>

### E02.1.4. Ceramic Tile

Applicable  N/A

Number of base standards 2

Image Tool 250 x 188



Type: **Style 1 Porcelain**

Applies to:  Group 1  Group 2  Group 3  Group 4  Other

Mfr: Daltille

Color: Earth tones

Finish: Matte, slip resistant

Model #: Porcelain tile

Other: Use in high traffic areas. Epoxy grout is recommended.

UFGS: Section 09 30 10 Ceramic, Quarry, and Glass Tiling  
<http://www.wbdg.org/FFC/DOD/UFGS/UFGS 09 30 10.pdf>





Type: **Style 2 Ceramic**

Applies to:  Group 1  Group 2  Group 3  Group 4  Other

Mfr: Daltile

Color: Earth tones

Finish: Matte, slip resistant

Model #: Ceramic tile

Other: Use in low traffic area toilet rooms.

UFGS: Section 09 30 10 Ceramic, Quarry, and Glass Tiling  
<http://www.wbdg.org/FFC/DOD/UFGS/UFGS 09 30 10.pdf>

### E02.1.5. Resilient Floor

Applicable  N/A

Number of base standards 1

Image Tool 250 x 188



Type: **Style 1 Stair Treads**

Applies to:  Group 1  Group 2  Group 3  Group 4  Other

Mfr: Roppe

Color: Neutral tones

Finish: Factory

Model #: Raised design rubber tread

Other: Stair treads material

UFGS: Section 09 65 00 Resilient Flooring  
<http://www.wbdg.org/FFC/DOD/UFGS/UFGS 09 65 00.pdf>

### E02.1.6. Carpet

Applicable  N/A

Number of base standards 2

Image Tool 250 x 188



Type: **Style 1**

Applies to:  Group 1  Group 2  Group 3  Group 4  Other

Mfr: Mohawk Group

Color: Neutral multi-colored tones/patterned/solid

Finish: Yarn: Nylon 6 or 6.6/cut pile or loop pile

Model #: Broadloom, 6' wide rolled, carpet tiles, entry walk-off carpet

Other: N/A

UFGS: UFGS 09 68 00 Carpeting

<http://www.wbdg.org/FFC/DOD/UFGS/UFGS 09 68 00.pdf>

Type: **Style 2**

Applies to:  Group 1  Group 2  Group 3  Group 4  Other

Mfr: Mohawk Group

Color: Earth tones

Finish: Factory

Model #: Broadloom, residential loop, "Smartstrand"

Other: May be used in lodging

UFGS: UFGS 09 68 00 Carpeting

<http://www.wbdg.org/FFC/DOD/UFGS/UFGS 09 68 00.pdf>

### E02.1.7. Rapidly-Renewable Products

Applicable  N/A

### E02.1.8. Other

Applicable  N/A

### E03. Walls

Comply with Air Force Corporate Standards for Walls:  
<http://afcs.wbdg.org/facilities-interiors/walls/index.html>

#### E03.1. Wall Materials

**Facility Group 1** wall materials shall be as follows.

Primary: Brick (or other as approved by the BCE)  
Secondary: Gypsum board (painted)  
Tertiary: Ceramic tile (restrooms)

**Facility Group 2** wall materials shall be as follows.

Primary: Brick  
Secondary: Gypsum board (painted)  
Tertiary: Ceramic tile (restrooms)

**Facility Group 3** wall materials shall be as follows.

Primary: Ground face block, sealed (do not paint)  
Secondary: N/A  
Tertiary: Ceramic tile (restrooms)

**Facility Group 4** wall materials shall be as follows.

Primary: N/A  
Secondary: N/A  
Tertiary: N/A

1. Follow UFC 3-450-01 (Vibration and Noise Control) for acoustic design issues including speech privacy, sound isolation or sound masking.
2. Select and apply paint with sheens (gloss levels) appropriate for the application following UFGS Section 09 90 00 Paints and Coatings.
3. Provide ceramic tile on wet walls of kitchens, toilet rooms, locker rooms, etc., in all facility groups.
4. Neutral split-face or ground-face integrally colored block with a clear sealer may be used in Group 3. Do not paint block.
5. Provide rubber base on drywall partitions in Groups 1 and 2.
6. Hardwood base may only be used in Group 1 as approved on a case basis.
7. Hardwood chair rails / bumper rails may be used in high-use areas of Groups 1 and 2; aqueous clear finishes are preferred to reduce maintenance; plastic chair rails are permitted only in medical applications.
8. Decorative moldings may be used only in Group 1 when approved on a case basis.
9. Corner guards are permitted only in high traffic spaces with wheeled or cart use such as private service areas in Groups 1 and 2; stainless steel corners guards with a brushed finish may be judiciously used in Group 3.
10. Group 4 may use painted composite wood base.
11. Manufacturers listed below are only provided to establish a baseline of equivalency among all applicable manufacturers.

**Note:** Apply the below base-wide standards for Walls (products, materials and color). Then refer to the Appendix and apply any additional requirements specifically related to the Facility District in which the project is located.



### E03.1.1. Concrete

Applicable  N/A

### E03.1.2. Masonry

Applicable  N/A

Number of base standards 1

Image Tool 250 x 188



Type: **Modular Face Brick**

Applies to:  Group 1  Group 2  Group 3  Group 4  Other

Mfr: Local (TBD)

Color: Red blend

Finish: Light texture

Model #: Coursed unit masonry

Other: Brick is preferred. Concrete block may only be used in Group 3 when approved by the BCE.

UGFS: Section 04 20 00 Unit Masonry

<http://www.wbdg.org/FFC/DOD/UGFS/UGFS 04 20 00.pdf>

### E03.1.3. Ceramic Tile

Applicable  N/A

Number of base standards 1

Image Tool 250 x 188

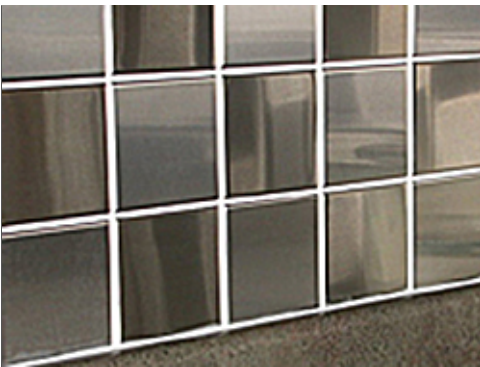

Type: **Style 1**

Applies to:  Group 1  Group 2  Group 3  Group 4  Other

Mfr: Daltile

Color: Earth tones

Finish: Gloss, Semi-gloss

Model #: Ceramic wall tile

Other: Located on wet walls in restrooms

UGFS: Section 09 30 10 Ceramic, Quarry, and Glass Tiling

<http://www.wbdg.org/FFC/DOD/UGFS/UGFS 09 30 10.pdf>

### E03.1.4. Gypsum Board

Applicable  N/A

Number of base standards 1

Image Tool 250 x 188



Type: **Style 1**

Applies to:  Group 1  Group 2  Group 3  Group 4  Other

Mfr: US Gypsum

Color: Solid Earth tone colors

Finish: Paint (Sheen per UFGS)

Model #: Tapered edge

Other: N/A

UFGS: Section 09 29 00 Gypsum Board  
<http://www.wbdg.org/FFC/DOD/UFGS/UFGS 09 29 00.pdf>  
Section 09 90 00 Paints and Coatings  
<http://www.wbdg.org/FFC/DOD/UFGS/UFGS 09 90 00.pdf>

### E03.1.5. Metal Panels

Applicable  N/A

### E03.1.6. Wood Paneling

Applicable  N/A

### E03.1.7. Rapidly-Renewable Products

Applicable  N/A

### E03.1.8. Other

Applicable  N/A

## E04. Ceilings

Comply with Air Force Corporate Standards for Ceilings:  
<http://afcs.wbdg.org/facilities-interiors/ceilings/index.html>

### E04.1. Ceiling Materials

**Facility Group 1** ceiling materials shall be as follows.

Primary: Exposed Framing (Roof / Floor Structure Above)  
Secondary: Grid and Acoustical Tile  
Tertiary:

**Facility Group 3** ceiling materials shall be as follows.

Primary: Exposed Framing (Roof / Floor Structure Above)  
Secondary: Exposed Framing (Roof / Floor Structure Above)  
Tertiary: Gypsum board (painted)

**Facility Group 2** ceiling materials shall be as follows.

Primary: Exposed Framing (Roof / Floor Structure Above)  
Secondary: Grid and Acoustical Tile  
Tertiary: Gypsum board (painted)

**Facility Group 4** ceiling materials shall be as follows.

Primary: N/A  
Secondary: N/A  
Tertiary: N/A

1. Accent ceiling materials such as metal, wood, and rapidly renewable may be used in Group 1 as approved on a case basis.
2. Follow UFC 3-450-01 (Vibration and Noise Control) for acoustic design issues including speech privacy, sound isolation or sound masking.
3. Manufacturers listed below are only provided to establish a baseline of equivalency among all applicable manufacturers.

**Note:** Apply the below *base-wide standards* for Ceilings (products, materials and color). Then refer to the Appendix and apply any additional requirements specifically related to the Facility District in which the project is located.

#### E04.1.1. Exposed Framing (Roof / Floor Structure Above)

Applicable  N/A      Number of base standards 1

Image Tool 250 x 188



Type: **Style 1**

Applies to:  Group 1  Group 2  Group 3  Group 4  Other

Mfr: Vulcraft

Color: Neutral colors reviewed on a case basis

Finish: Field painted (Sheen per UFGS)

Model #: Formlok floor and roof decking

Other: N/A

UFGS: Section 05 30 00 Steel Decks  
<http://www.wbdg.org/FFC/DOD/UFGS/UFGS 05 30 00.pdf>



### E04.1.2. Exposed Concrete

Applicable  N/A

### E04.1.3. Grid and Acoustical Tile

Applicable  N/A Number of base standards 1

Image Tool 250 x 188



Type: **Style 1**

Applies to:  Group 1  Group 2  Group 3  Group 4  Other

Mfr: Armstrong

Color: White

Finish: Factory

Model #: 2'x2' Tegular with reveal edge and fine texture, grid 15/16"

Other: Performance characteristics are Class A; NRC-0.70; CAC-40; LR-0.86; minimum recycled content 82%.

UFGS: Section 09 51 00 Acoustical Ceilings  
<http://www.wbdg.org/FFC/DOD/UFGS/UFGS 09 51 00.pdf>

### E04.1.4. Gypsum Board

Applicable  N/A Number of base standards 1

Image Tool 250 x 188



Type: **Style 1**

Applies to:  Group 1  Group 2  Group 3  Group 4  Other

Mfr: US Gypsum

Color: Solid neutral colors

Finish: Paint (sheen per UFGS)

Model #: Tapered edge

Other: N/A

UFGS: Section 09 29 00 Gypsum Board  
<http://www.wbdg.org/FFC/DOD/UFGS/UFGS 09 29 00.pdf>  
Section 09 90 00 Paints and Coatings  
<http://www.wbdg.org/FFC/DOD/UFGS/UFGS 09 90 00.pdf>

#### **E04.1.5. Metal Panels**

Applicable  N/A

---

#### **E04.1.6. Wood**

Applicable  N/A

---

#### **E04.1.7. Rapidly-Renewable Products**

Applicable  N/A

---

#### **E04.1.8. Other**

Applicable  N/A

---

### **E05. Doors and Windows**

Comply with Air Force Corporate Standards for Doors and Windows:

<http://afcs.wbdg.org/facilities-interiors/doors-and-windows/index.html>

#### **E05.1. Doors and Windows and Frames Materials**

**Facility Group 1**

door (frame) and window frame materials shall be as follows.

Primary: Aluminum, clear anodized

Secondary: Hollow metal (painted)

Tertiary: N/A

**Facility Group 1**

door (leaf) materials shall be as follows.

Primary: Hardwood veneer

Secondary: Hollow metal (painted)

Tertiary: N/A

**Facility Group 2**

door (frame) and window frame materials shall be as follows.

Primary: Aluminum, clear anodized

Secondary: Hollow metal (painted)

Tertiary: N/A

**Facility Group 2**

door (leaf) materials shall be as follows.

Primary: Hardwood veneer

Secondary: Hollow metal (painted)

Tertiary: N/A

**Facility Group 3**

door (frame) and window frame materials shall be as follows.

Primary: Hollow metal (galvanized, painted)

Secondary: Hollow metal (galvanized, painted)

Tertiary: N/A

**Facility Group 3**

door (leaf) materials shall be as follows.

Primary: Hollow metal (galvanized, painted)

Secondary: Hollow metal (galvanized, painted)

Tertiary: N/A

**Facility Group 4**

door (frame) and window frame materials shall be as follows.

Primary: N/A

Secondary: N/A

Tertiary: N/A

**Facility Group 4**

door (leaf) materials shall be as follows.

Primary: N/A

Secondary: N/A

Tertiary: N/A

1. Hardwood casings may be provided over metal frames in Group 1 as approved on a case basis.
2. Paneled textured doors may be used in distinguished visitors lodging.
3. Do not use hollow-core wood doors.
4. Generally match original hardware in renovations.
5. Manufacturers listed below are only provided to establish a baseline of equivalency among all applicable manufacturers.

**Note:** Apply the below *base-wide standards* for Doors and Windows (products, materials and color). Then refer to the Appendix and apply any additional requirements specifically related to the Facility District in which the project is located.



### E05.1.1. Aluminum

Applicable  N/A

Number of base standards 1

Image Tool 250 x 188



Type: **Style 1**

Applies to:  Group 1  Group 2  Group 3  Group 4  Other

Mfr: Kawneer

Color: Clear anodized

Finish: Factory

Model #: InFrame Interior Framing, (2x4 nominal framing)

Other: Satin stainless steel hardware

UGFS: Section 08 41 13 Aluminum-Framed Entrances and Storefronts  
<http://www.wbdg.org/FFC/DOD/UGFS/UGFS 08 41 13.pdf>  
Section 08 71 00 Door Hardware  
<https://www.wbdg.org/FFC/DOD/UGFS/UGFS 08 71 00.pdf>

### E05.1.2. Hollow Metal

Applicable  N/A

Number of base standards 2

Image Tool 250 x 188



Type: **Steel Doors**

Applies to:  Group 1  Group 2  Group 3  Group 4  Other

Mfr: Steelcraft

Color: Neutral colors

Finish: Paint (Sheen per UFGS)

Model #: Hollow metal, 2" w. frames, 16 gauge (welded corners) grouted solid

Other: Provide in Group 3 and in utility areas of Group 1 and 2. Provide A25 "galvannealed" coating. All interior steel doors will have a factory applied primer finish. Provide satin stainless steel hardware.

UGFS: Section 08 11 13 Steel Doors and Frames  
<http://www.wbdg.org/FFC/DOD/UGFS/UGFS 08 11 13.pdf>  
Section 08 71 00 Door Hardware  
<https://www.wbdg.org/FFC/DOD/UGFS/UGFS 08 71 00.pdf>

Type: **Steel Frames**

Applies to:  Group 1  Group 2  Group 3  Group 4  Other

Mfr: Steelcraft

Color: Neutral colors

Finish: Paint (Sheen per UFGS)

Model #: Hollow metal, frame grouted solid

Other: Satin stainless steel hardware

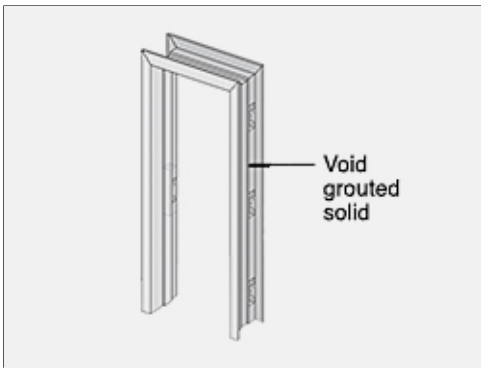

UFGS: Section 08 11 13 Steel Doors and Frames

<http://www.wbdg.org/FFC/DOD/UFGS/UFGS 08 11 13.pdf>

Section 08 71 00 Door Hardware

<https://www.wbdg.org/FFC/DOD/UFGS/UFGS 08 71 00.pdf>

### E05.1.3. Wood

Applicable  N/A

Number of base standards 2

Image Tool 250 x 188

Type: **Style 1, Administrative**

Applies to:  Group 1  Group 2  Group 3  Group 4  Other

Mfr: Simpson

Color: Natural hardwood veneer

Finish: Clear Sealer, satin (aqueous)

Model #: 3'x7'x 1 3/4", solid core

Other: Satin stainless steel hardware, Glass lites may be used. Stained birch veneer face, 5 ply construction, rotary cut finish.



UFGS: Section 08 14 00 Wood Doors

<http://www.wbdg.org/FFC/DOD/UFGS/UFGS 08 14 00.pdf>

Section 08 71 00 Door Hardware

<https://www.wbdg.org/FFC/DOD/UFGS/UFGS 08 71 00.pdf>

Type: **Style 2, Residential**

---

Applies to:  Group 1  Group 2  Group 3  Group 4  Other

Mfr: Simpson

---

Color: Natural hardwood veneer or paint grade

---

Finish: Clear Sealer or paint, satin (aqueous)

---

Model #: Full slab or panels

---

Other: Satin nickel hardware, panel doors may be used in DV lodging

---



---

UGFS: Section 08 14 00 Wood Doors  
<http://www.wbdg.org/FFC/DOD/UGFS/UGFS 08 14 00.pdf>  
Section 08 71 00 Door Hardware  
<https://www.wbdg.org/FFC/DOD/UGFS/UGFS 08 71 00.pdf>

---

#### **E05.1.4. Other**

Applicable  N/A

---

### **E06. Casework Systems**

Comply with Air Force Corporate Standards for Casework Systems:

<http://afcfs.wbdg.org/facilities-interiors/casework-systems/index.html>

#### **E06.1. Casework Materials**

1. Select casework systems and materials considering durability, maintenance requirements and LCCA.
2. Natural stone and cast stone countertops may only be used in Group 1 with approval on a case basis.
3. Metal cabinets and countertops will be provided in heavy-use operations and in Group 3.
4. Refer to AFCFS for approved materials.
5. Manufacturers listed below are only provided to establish a baseline of equivalency among all applicable manufacturers.



### E06.1.1. Plastic Laminate

Applicable  N/A

Number of base standards 1

Image Tool 250 x 188



Type: **Style 1, Low Use Areas**

Applies to:  Group 1  Group 2  Group 3  Group 4  Other

Mfr: Formica

Color: Medium Earth tones and neutral tones

Finish: Light textured

Model #: High pressure laminate

Other: Combine with matching solid-surface banding on casework edges.

UFGS: Section 06 41 16.00 10 Plastic-Laminate-Clad Architectural Cabinets  
[http://www.wbdg.org/FFC/DOD/UFGS/UFGS\\_06\\_41\\_16.00\\_10.pdf](http://www.wbdg.org/FFC/DOD/UFGS/UFGS_06_41_16.00_10.pdf)

### E06.1.2. Solid Polymer Surface

Applicable  N/A

Number of base standards 1

Image Tool 250 x 188



Type: **Style 1, High Use Areas**

Applies to:  Group 1  Group 2  Group 3  Group 4  Other

Mfr: Corian

Color: Medium Earth tones and neutral tones

Finish: Light textured

Model #: Solid Surface

Other: Faces and edge banding

UFGS: Section 12 36 00 Countertops  
[http://www.wbdg.org/FFC/DOD/UFGS/UFGS\\_12\\_36\\_00.pdf](http://www.wbdg.org/FFC/DOD/UFGS/UFGS_12_36_00.pdf)

### E06.1.3. Rapidly-Renewable Products

Applicable  N/A

Number of base standards 1

Image Tool 250 x 188



Type: **Style 1 Moderate Use Areas**

Applies to:  Group 1  Group 2  Group 3  Group 4  Other

Mfr: Plyboo

Color: Natural or amber

Finish: Satin

Model #: Flat grain bamboo plywood

Other: FSC® Certified 100%.

UFGS: Section 12 32 00 Manufactured Wood Casework  
<http://www.wbdg.org/FFC/DOD/UFGS/UFGS 12 32 00.pdf>

### E06.1.4. Metal

Applicable  N/A

Number of base standards 1

Image Tool 250 x 188



Type: **Style 1**

Applies to:  Group 1  Group 2  Group 3  Group 4  Other

Mfr: Steel Sentry

Color: Natural stainless steel or neural colors (steel)

Finish: Mill (stainless) or Powder coated (steel)

Model #: Lab, workbench, computer workstation

Other: Provide highly durable fabrications and finishes in Group 3 which are subjected to heavy use.

UFGS: Section 12 31 00 Manufactured Metal Casework  
<http://www.wbdg.org/FFC/DOD/UFGS/UFGS 12 31 00.pdf>

### E06.1.5. Other

Applicable  N/A

---

## E06.2. Countertop Materials

### E06.2.1. Plastic Laminate

Applicable  N/A      Number of base standards 1

Image Tool 250 x 188



Type: **Style 1, Low Use Areas**

Applies to:  Group 1  Group 2  Group 3  Group 4  Other

Mfr: Formica

Color: Medium Earth tones and neutral tones

Finish: Light textured

Model #: High pressure laminate

Other: Only use rounded half or full bullnose and integral backsplash. Do not use plastic laminate edge banding on front edges.

UFGS: Section 06 41 16.00 10 Plastic-Laminate-Clad Architectural Cabinets  
[http://www.wbdg.org/FFC/DOD/UFGS/UFGS\\_06\\_41\\_16.00\\_10.pdf](http://www.wbdg.org/FFC/DOD/UFGS/UFGS_06_41_16.00_10.pdf)

---

### E06.2.2. Solid Polymer Surface

Applicable  N/A      Number of base standards 1

Image Tool 250 x 188



Type: **Style 1, High Use Areas**

Applies to:  Group 1  Group 2  Group 3  Group 4  Other

Mfr: Corian

Color: Medium Earth tones and neutral tones

Finish: Light textured

Model #: Solid Surface

Other: Faces and edges

UFGS: Section 12 36 00 Countertops  
[http://www.wbdg.org/FFC/DOD/UFGS/UFGS\\_12\\_36\\_00.pdf](http://www.wbdg.org/FFC/DOD/UFGS/UFGS_12_36_00.pdf)



### E06.2.3. Natural Stone

Applicable  N/A

Number of base standards 1

Image Tool 250 x 188



Type: **Style 1, Group 1 High Visibility, Heavy Use**

Applies to:  Group 1  Group 2  Group 3  Group 4  Other

Mfr: Local (TBD)

Color: Neutral tones

Finish: High polish, sealer

Model #: Custom cut slabs

Other: N/A

UFGS: Section 12 36 00 Countertops

[http://www.wbdg.org/FFC/DOD/UFGS/UFGS 12 36 00.pdf](http://www.wbdg.org/FFC/DOD/UFGS/UFGS_12_36_00.pdf)

### E06.2.4. Cast Stone

Applicable  N/A

Number of base standards 1

Image Tool 250 x 188

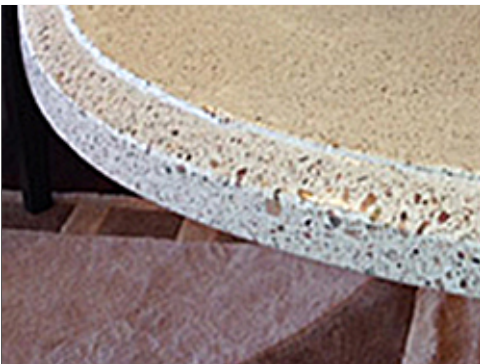

Type: **Style 1, Group 1 High Visibility, Heavy Use**

Applies to:  Group 1  Group 2  Group 3  Group 4  Other

Mfr: Local (TBD)

Color: Neutral tones

Finish: High polish, sealer

Model #: Custom cast or cut slabs

Other: N/A

UFGS: Section 12 36 00 Countertops

[http://www.wbdg.org/FFC/DOD/UFGS/UFGS 12 36 00.pdf](http://www.wbdg.org/FFC/DOD/UFGS/UFGS_12_36_00.pdf)

### E06.2.5. Metal

Applicable  N/A

Number of base standards 1

Image Tool 250 x 188

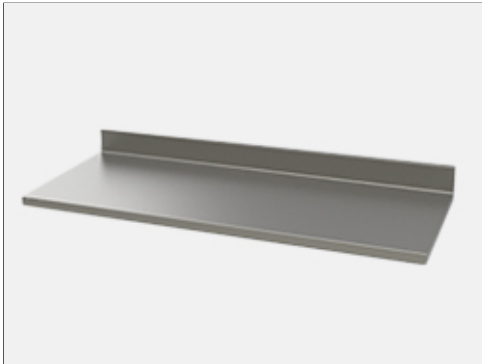

Type: \_\_\_\_\_

Applies to:  Group 1  Group 2  Group 3  Group 4  Other

Mfr: Local (TBD)

Color: Natural stainless steel

Finish: Mill

Model #: Custom fabricated countertops

Other: Provide integral fronts, sides and backsplash

UGFS: Section 12 31 00 Manufactured Metal Casework  
<http://www.wbdg.org/FFC/DOD/UGFS/UGFS 12 31 00.pdf>

### E06.2.6. Other

Applicable  N/A

## E07. Furnishings

Comply with Air Force Corporate Standards for Furnishings:  
<http://afcs.wbdg.org/facilities-interiors/furnishings/index.html>

### E07.1. Durability and Serviceability

Comply with AF Corporate Standards for Durability and Serviceability:  
<http://afcs.wbdg.org/facilities-interiors/furnishings/durability-and-serviceability/index.html>

### E07.2. Accessories

Comply with AF Corporate Standards for Accessories:  
<http://afcs.wbdg.org/facilities-interiors/furnishings/accessories/index.html>

1. Comply with AFCFS.

## E08. Interior Signs

Comply with Air Force Corporate Standards for Interior Signs:  
<http://afcs.wbdg.org/facilities-interiors/interior-signs/index.html>

### E08.1 Types and Color

Comply with Air Force Corporate Standards for Types and Color:  
<http://afcfs.wbdg.org/facilities-interiors/interior-signs/types-and-color/index.html>

## **E08.2. Interior Signs Materials**

1. Natural stone, masonry and cast stone signs may only be used in Group 1 with approval on a case basis.
2. Comply with AFCFS.

## **E09. Lighting, Power and Communication**

<http://afcfs.wbdg.org/facilities-interiors/lighting-power-and-communication/index.html>

### **E09.1. Functionality and Efficiency**

Comply with Air Force Corporate Standards for Functionality and Efficiency:  
<http://afcfs.wbdg.org/facilities-interiors/lighting-power-and-communication/functionality-and-efficiency/index.html>

### **E09.2. Types and Color**

1. Comply with AFCFS.



## F. APPENDIX - Facility Districts

- Applicable
- N/A

Comply with Air Force Corporate Standards for Facility Districts:

<http://afcs.wbdg.org/facility-districts/index.html>

Facilities Districts Overview Map:

Image Tool 800 x 600

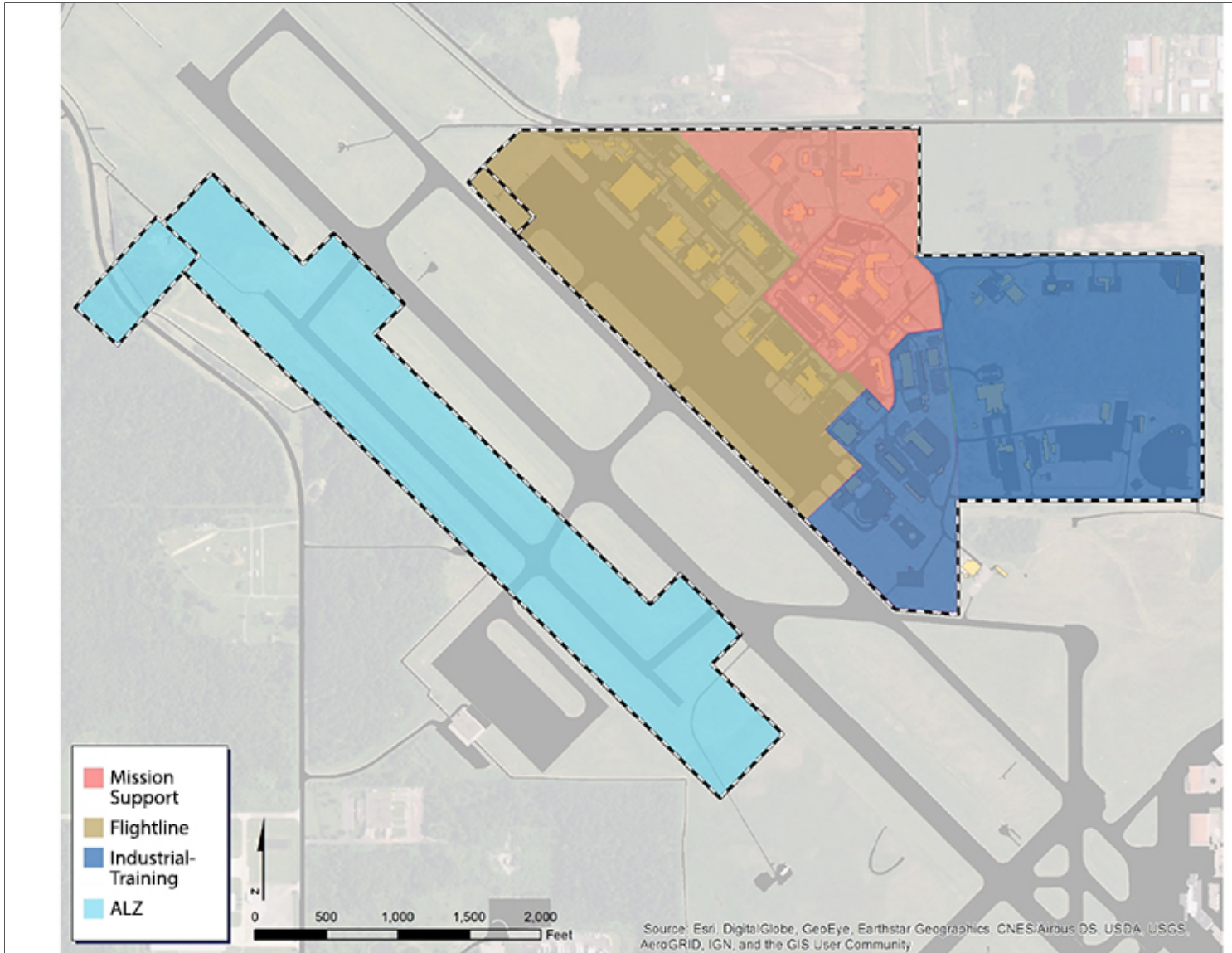

**Note:** Apply the base-wide standards in this IFS for Installation Elements, Site Development, Facilities Exteriors and Facilities Interiors (products, materials, color, etc.). Following application of the base-wide standards, refer to the Appendix and apply any additional requirements specifically related to the Facility District.

Enter No. of Facility Districts 1

The following Facility Districts list exceptions to the base standards that are unique to each district. Please refer to the Site Development, Facilities Exteriors, and Facilities Interiors sections of this IFS for base standards.

Name of District: Apply Base-wide Standards in All Districts

Image Tool 800 x 600

Map of District

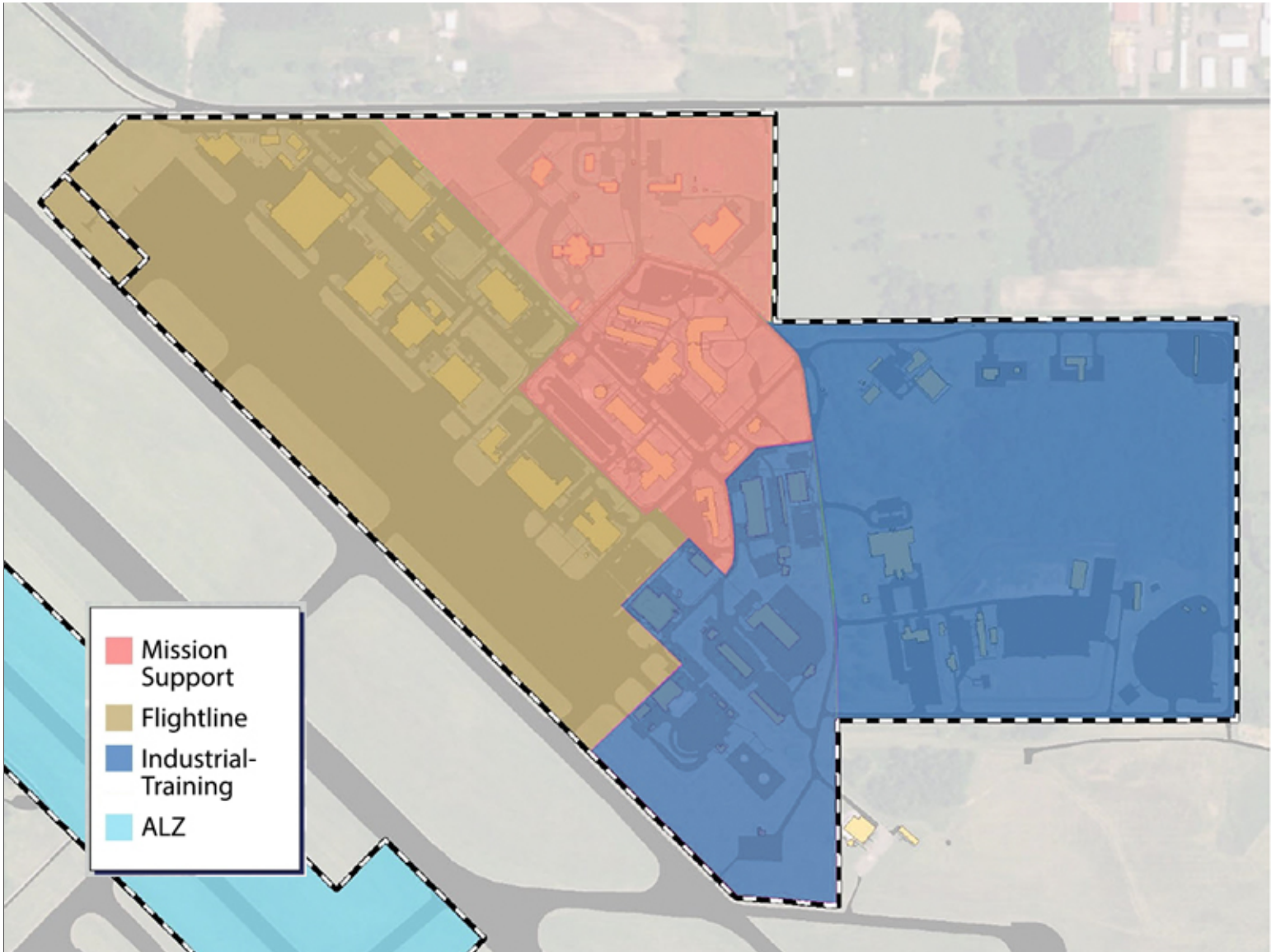

Photos for each facility group within the Facility District as applicable.

Image Tool 250 x 188

Group 1     Applicable     N/A

Group 2     Applicable     N/A

Group 3     Applicable     N/A

Group 4     Applicable     N/A

Other       Applicable     N/A

## **FACILITY DISTRICTS**

Youngstown Air Reserve Station is divided into districts that align with land use zones as defined in the Installation Development Plan (IDP). Each district has designated uses that support the base's operations. Generally match adjacent facilities in new construction to promote architectural compatibility throughout the installation. Please refer to Section D03.2. and contact the 910 Civil Engineer Squadron (CES) for additional information. A brief description of each district follows.

### **1. Mission Support**

The Mission Support district will remain pedestrian in scale. Application of the installation prevailing architectural theme, Contemporary Vernacular, will be implemented during major renovations or new construction as appropriate. New facilities and major renovations in this district will generally match adjacent buildings to ensure architectural compatibility and will follow standards for Facility Groups 1 and 2 as defined in this IFS.

### **2. Flightline**

Large facilities in the Flightline district will have sub-massing to promote a pedestrian scale. Application of the installation prevailing architectural theme, Contemporary Vernacular, will be implemented during major renovations or new construction as appropriate. New facilities and major renovations in this district will generally match adjacent buildings to ensure architectural compatibility and will follow standards for Facility Group 3 as defined in this IFS.

### **3. Industrial-Training**

The Industrial-Training district will be pedestrian in scale. Application of the installation prevailing architectural theme, Contemporary Vernacular, will be implemented during major renovations or new construction as appropriate. New facilities and major renovations in this district will generally match adjacent buildings to ensure architectural compatibility and will follow standards for Facility Group 3 as defined in this IFS.

### **4. ALZ**

The ALZ district is predominantly open space. Any new facilities in this district will generally match flightline buildings to ensure architectural compatibility and will follow standards for Facility Group 3 as defined in this IFS.

### **Open Space and Preserves**

Open space includes undeveloped land both inside and outside of the immediate cantonment area. It both separates and defines the various sections of the base and creates a natural setting for the cantonment area. Areas classified as open space may be undeveloped to act as a buffer space between incompatible uses or for safety or security clearances or there may be other constraints that are not readily visible. All development in this district requires prior coordination and approval from CES.

## **G. APPENDIX - References**

Comply with Air Force Corporate Standards:

<http://afcs.wbdg.org/index.html>

Note: The below listed Supplementary Documents are provided as part of this IFS and will become fully part of the IFS. If there are any discrepancies between the requirements of this IFS and the Supplementary Documents, the IFS will govern.

910th CIVIL ENGINEER SQUADRON

G01 Youngstown ARS IFS Painting Standards

[\(Link to be provided\)](#)